



EVQ4432-L-00A

36V, 2.2A, Low Quiescent Current, Synchronous Step-Down Converter Evaluation Board

DESCRIPTION

The EVQ4432-L-00A evaluation board is designed to demonstrate the capabilities of the MPQ4432 and the MPQ4432-AEC1.

The MPQ4432 is a frequency-configurable (350kHz to 2.5MHz), synchronous, step-down switching regulator with integrated, internal high-side and low-side power MOSFETs. It provides up to 2.2A of highly efficient output current with current mode control for fast loop response.

The MPQ4432 employs advanced asynchronous modulation (AAM) mode to achieve high efficiency under light-load conditions by scaling down the switching frequency. This reduces the switching and gate driving losses.

The EVQ4432-L-00A is a fully assembled and tested evaluation board that generates 5V of output voltage at load currents up to 2.2A, from a 5V to 36V input voltage range.

The MPQ4432 is available in a QFN-16 (3mmx4mm) package.

ELECTRICAL SPECIFICATIONS

Parameter	Symbol	Value	Units
Input voltage	V_{EMI}	5 to 36	V
Output voltage	V_{OUT}	5	V
Output current	I_{OUT}	2.2	A

FEATURES

- Wide 5V to 36V Operating Input Range
- 2.2A of Continuous Output Current
- 1 μ A Low Shutdown Mode Current
- 10 μ A Sleep Mode Quiescent Current
- Internal 90m Ω High-Side and 40m Ω Low-Side MOSFETs
- 350kHz to 2.5MHz Configurable Switching Frequency
- Synchronize to External Clock, Selectable In-Phase or 180° Out-of-Phase
- Power Good Indicator
- Configurable Soft-Start Time
- 80ns Minimum On Time
- Selectable FCCM and AAM
- Low-Dropout Mode
- Over-Current Protection with Valley-Current Detection and Hiccup Mode
- Thermal Shutdown
- Available in a QFN-16 (3mmx4mm) Package
- Available with Wettable Flanks
- Available in AEC-Q100 Grade 1

APPLICATIONS

- Automotive Systems
- Industrial Power Systems

All MPS parts are lead-free, halogen-free, and adhere to the RoHS directive. For MPS green status, please visit the MPS website under Quality Assurance. "MPS", the MPS logo, and "Simple, Easy Solutions" are trademarks of Monolithic Power Systems, Inc. or its subsidiaries.



EVQ4432-L-00A EVALUATION BOARD

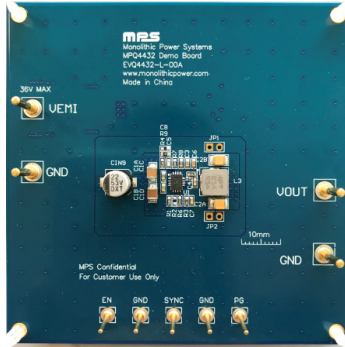

LxWxH (8.3cmx8.3cmx1.3cm)

Board Number	MPS IC Number
EVQ4432-L-00A	MPQ4432GL, MPQ4432GL-AEC1

Efficiency vs. Load Current

V_{OUT} = 5V, AAM

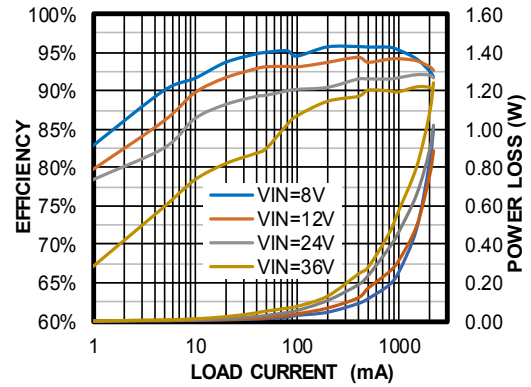

QUICK START GUIDE

1. Preset the power supply (V_{IN}) to be between 5V and 36V.
Note that electronic loads represent a negative impedance to the regulator. If the current is set too high, hiccup mode may be triggered.
2. Turn the power supply off.
If longer cables (>0.5m total) are used between the source and the evaluation board, a damping capacitor should be installed at the input terminals, especially if $V_{IN} \geq 24V$.
3. Connect the power supply terminals to:
 - a. Positive (+): VEMI
 - b. Negative (-): GND
4. Connect the load terminals to:
 - a. Positive (+): VOUT
 - b. Negative (-): GND
5. Turn the power supply on after making the connections.
6. To use the enable function, apply a digital input to the EN pin. Drive EN above 1.05V to turn the device on; drive EN below 0.93V to turn it off.
7. The IC's oscillating frequency can be configured by an external frequency resistor (R_{FREQ}). R_{FREQ} can be estimated with Equation (1):

$$R_{FREQ}(\text{k}\Omega) = \frac{170000}{f_{SW}^{1.11}(\text{kHz})} \quad (1)$$

8. To use the sync function, apply a 350kHz to 2.5MHz clock to the SYNC pin to synchronize the internal oscillator frequency to the external clock. The external clock should be at least 250kHz above the frequency set by R_{FREQ} . The SYNC pin can also select forced continuous conduction mode (FCCM) or advanced asynchronous mode (AAM). Drive SYNC high before the chip starts up to choose FCCM; drive SYNC low (or leave it floating) to select AAM.
9. The output voltage is set by the external resistor divider. The feedback resistor (R_{FB1}) also sets the feedback loop bandwidth with the internal compensation capacitor. Choose R_{FB1} to be about 40k Ω . R_{FB2} can be calculated with Equation (2):

$$R_{FB2} = \frac{R_{FB1}}{\frac{V_{OUT}}{0.8V} - 1} \quad (2)$$

Figure 1 shows the resistor divider set-up.

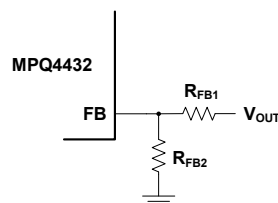

Figure 1: Resistor Divider Set-Up



Table 1 lists the recommended feedback resistor values for common output voltages.

Table 1: Recommended Resistor Dividers

V_{OUT} (V)	R_{FB1} (kΩ)	R_{FB2} (kΩ)
1.8	41.2 (1%)	33 (1%)
2.5	41.2 (1%)	19.6 (1%)
3.3	41.2 (1%)	13 (1%)
5	41.2 (1%)	7.68 (1%)
12	41.2 (1%)	2.94 (1%)

EVALUATION BOARD SCHEMATIC

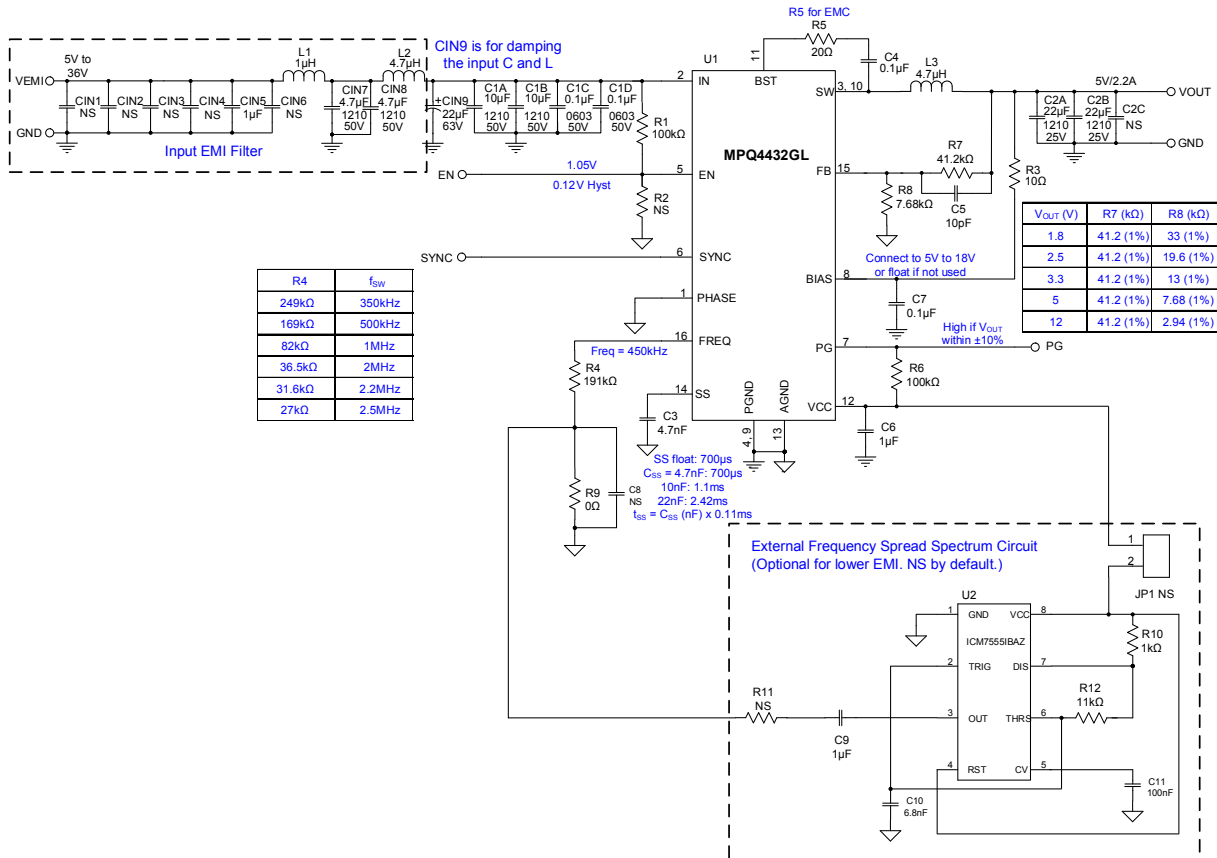
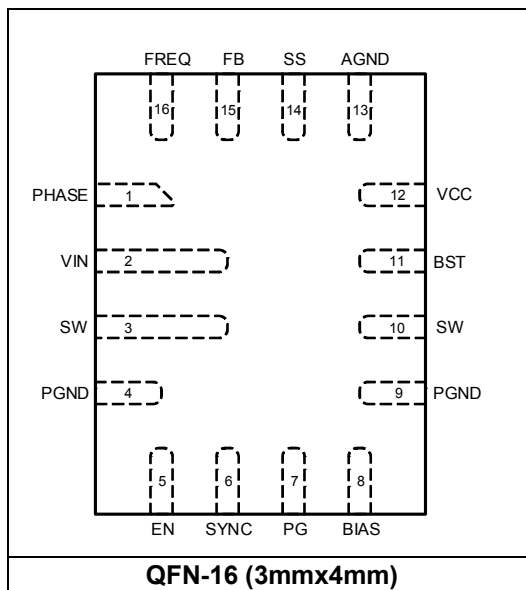

Figure 2: Evaluation Board Schematic

PACKAGE REFERENCE



EVQ4432-L-00A BILL OF MATERIALS

Qty	Ref	Value	Description	Package	Manufacturer	Manufacturer PN
1	CIN5	1 μ F	Ceramic capacitor, 50V, X7R	0805	Murata	GRM21BR71H105KA12L
2	CIN7, CIN8	4.7 μ F	Ceramic capacitor, 50V, X7R	1210	Murata	GRM32ER71H475KA88L
1	CIN9	22 μ F	Electrolytic capacitor, 63V	SMD	Jianghai	VTD-63V22
2	C1A, C1B	10 μ F	Ceramic capacitor, 50V, X7R	1210	Murata	GRM32ER71H106KA12L
2	C1C, C1D	0.1 μ F	Ceramic capacitor, 50V, X7R	0603	Murata	GRM188R71H104KA93D
2	C2A, C2B	22 μ F	Ceramic capacitor, 25V, X7R	1210	Murata	GRM32ER71H226KE15L
1	C3	4.7nF	Ceramic capacitor, 50V, X7R	0603	TDK	C1608X7R1H472K
3	C4, C7, C11	0.1 μ F	Ceramic capacitor, 16V, X7R	0603	Murata	GRM188R71C104KA01D
1	C5	10pF	Ceramic capacitor, 50V, C0G	0603	Murata	GRM1885C1H100JA01
2	C6, C9	1 μ F	Ceramic capacitor, 16V, X7R	0603	Murata	GRM188R71C105KA12D
1	C10	6.8nF	Ceramic capacitor, 50V, X7R	0603	TDK	C1608X7R1H682K
7	CIN1, CIN2, CIN3, CIN4, CIN6, C2C, C8	NS				
2	JP1, JP2	NS				
1	L1	1 μ H	Inductor, DCR = 41m Ω , 3.1A	SMD	Cyntec	VCTA20161B-1R0MS6-89
1	L2	4.7 μ H	Inductor, DCR = 48.6m Ω , 3.7A	SMD	Cyntec	VCHA042A-4R7MS6-89
1	L3	4.7 μ H	Inductor, DCR = 31.5m Ω , 6A	SMD	Cyntec	VCMT063T-4R7MN5-89
2	R1, R6	100k Ω	Film resistor, 1%	0603	Yageo	RC0603FR-07100KL
1	R3	10 Ω	Film resistor, 1%	0603	Yageo	RC0603FR-0710RL
1	R4	191k Ω	Film resistor, 1%	0603	Yageo	RC0603FR-07191KL
1	R5	20 Ω	Film resistor, 1%	0603	Yageo	RC0603FR-0720RL
1	R7	41.2k Ω	Film resistor, 1%	0603	Yageo	RC0603FR-0741K2L
1	R8	7.68k Ω	Film resistor, 1%	0603	Yageo	RC0603FR-0713KL

**EVQ4432-L-00A BILL OF MATERIALS (continued)**

Qty	Ref	Value	Description	Package	Manufacturer	Manufacturer PN
1	R10	1k Ω	Film resistor, 1%	0603	Yageo	RC0603FR-071KL
1	R9	0 Ω	Film resistor, 1%	0603	Yageo	RC0603FR-070RL
1	R12	11k Ω	Film resistor, 1%	0603	Yageo	RC0603FR-0711KL
2	R2, R11	NS				
1	U2	18V	CMOS RC timer	SOP-8	Intersil	ICM7555IBAZ
4	VEMI, GND, VOUT, GND	Test point	2.0 golden pin	DIP	Any	
5	EN, GND, SYNC, GND, PG	Test point	1.0 golden pin	DIP	Any	
1	U1	MPQ4332	Step-down converter	QFN-16 (3mmx 4mm)	MPS	MPQ4432GL

EVB TEST RESULTS

Performance curves and waveforms are tested on the evaluation board. $V_{IN} = 12V$, $V_{OUT} = 5V$, $L = 4.7\mu H$, $f_{sw} = 450kHz$, $T_A = 25^\circ C$, unless otherwise noted.

Efficiency vs. Load Current

$V_{OUT} = 5V$, AAM

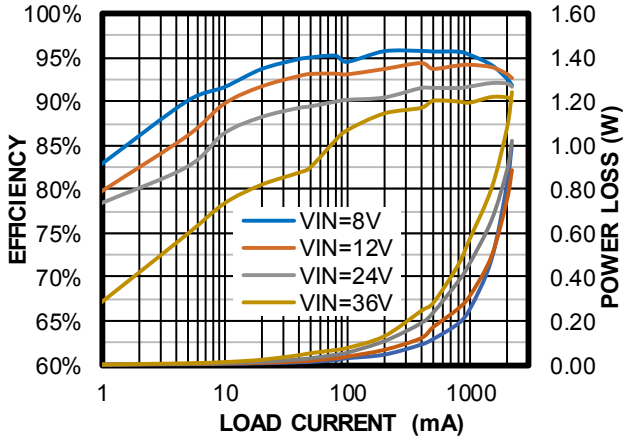

Efficiency vs. Load Current

$V_{OUT} = 5V$, CCM

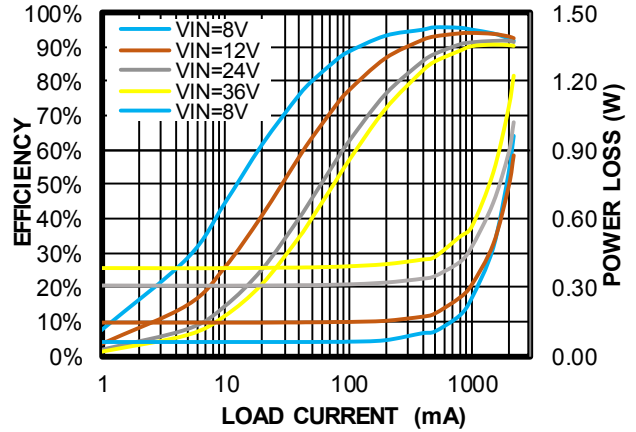

EVB TEST RESULTS (continued)

Performance curves and waveforms are tested on the evaluation board. $V_{IN} = 12V$, $V_{OUT} = 5V$, $L = 4.7\mu H$, $f_{sw} = 450kHz$, $T_A = 25^\circ C$, unless otherwise noted.

Steady State

$I_{OUT} = 0A$, AAM

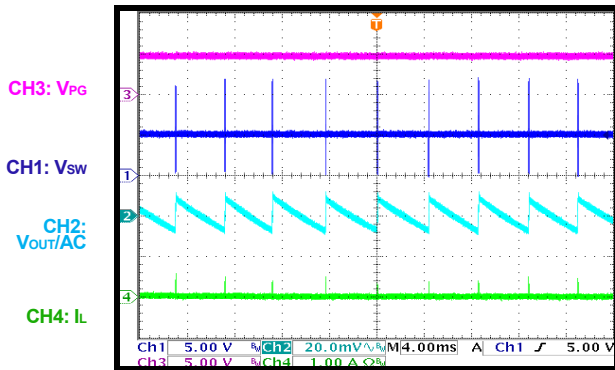

Steady State

$I_{OUT} = 0A$, CCM

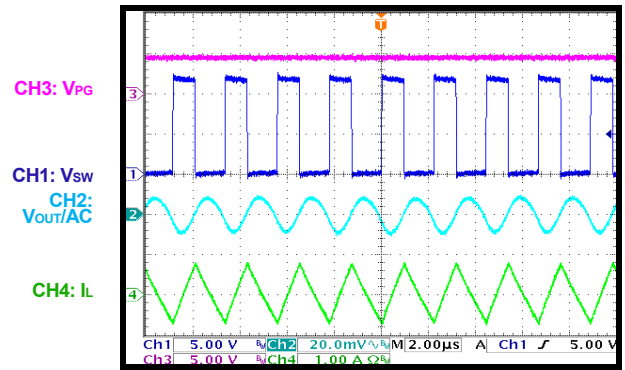

Steady State

$I_{OUT} = 2A$

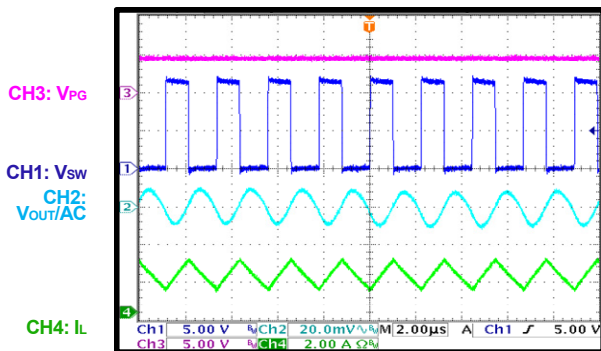

Start-Up

$I_{OUT} = 0A$, AAM

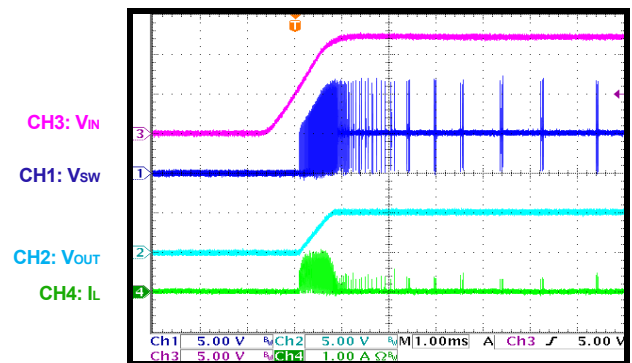

Start-Up

$I_{OUT} = 0A$, CCM

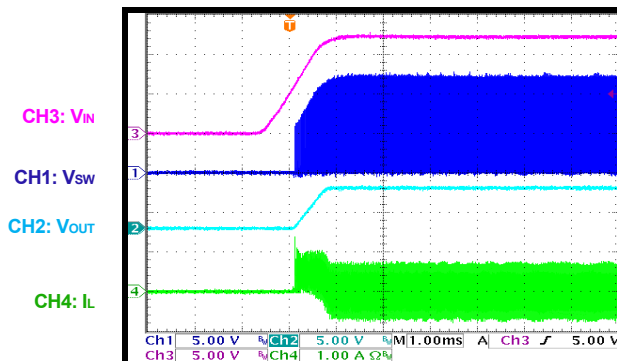

Start-Up

$I_{OUT} = 2A$

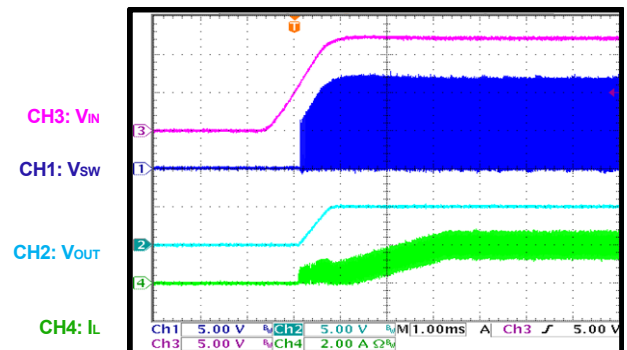

EVB TEST RESULTS (continued)

Performance curves and waveforms are tested on the evaluation board. $V_{IN} = 12V$, $V_{OUT} = 5V$, $L = 4.7\mu H$, $f_{sw} = 450kHz$, $T_A = 25^\circ C$, unless otherwise noted.

Shutdown
 $I_{OUT} = 0A$, AAM

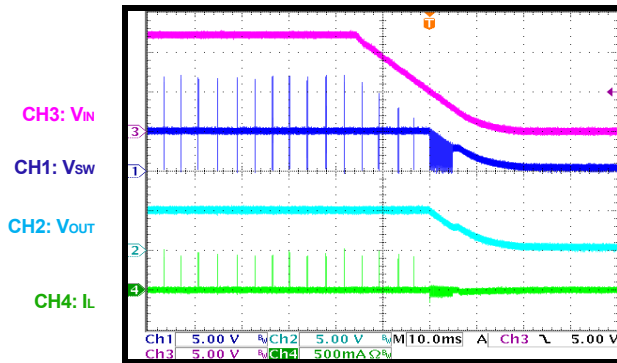

Shutdown
 $I_{OUT} = 0A$, CCM

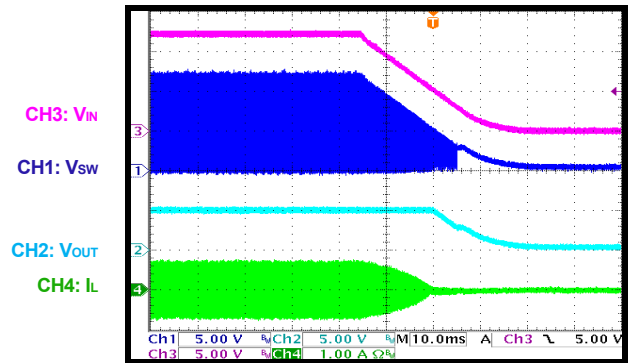

Shutdown
 $I_{OUT} = 2A$

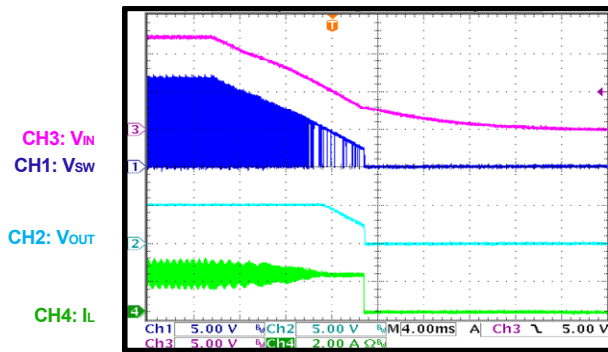

En On
 $I_{OUT} = 0A$, AAM

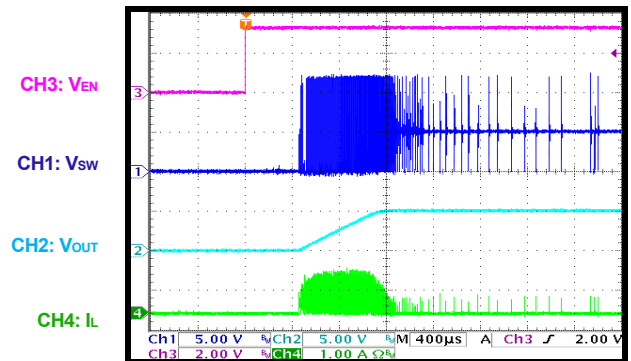

En On
 $I_{OUT} = 0A$, CCM

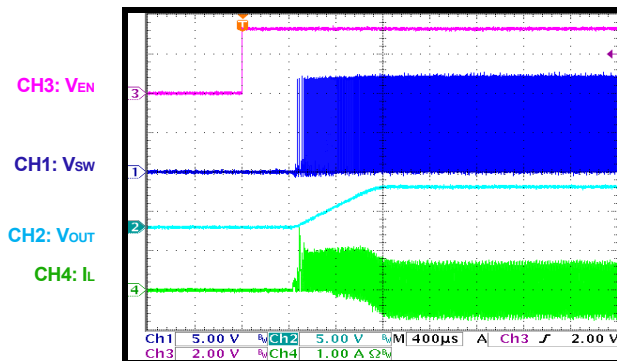

En On
 $I_{OUT} = 2A$

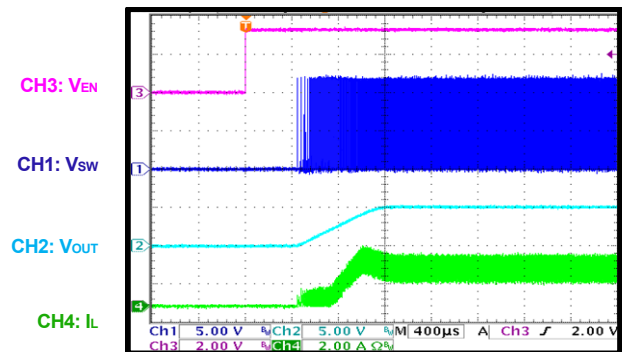

EVB TEST RESULTS (continued)

Performance curves and waveforms are tested on the evaluation board. $V_{IN} = 12V$, $V_{OUT} = 5V$, $L = 4.7\mu H$, $f_{sw} = 450kHz$, $T_A = 25^\circ C$, unless otherwise noted.

En Off
 $I_{OUT} = 0A$, AAM

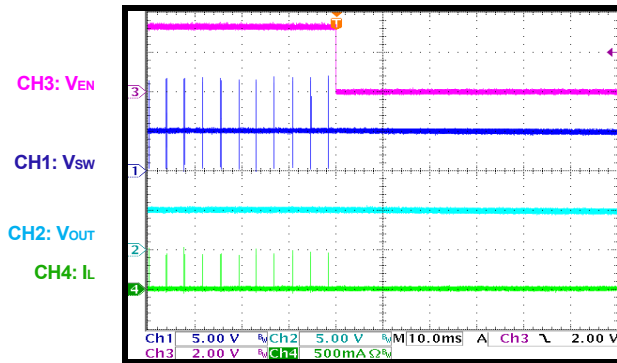

En Off
 $I_{OUT} = 0A$, CCM

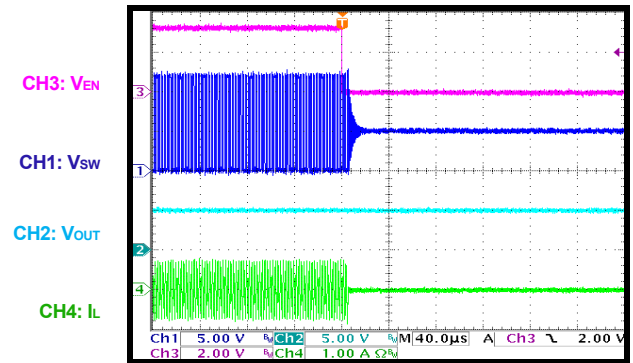

En Off
 $I_{OUT} = 2A$

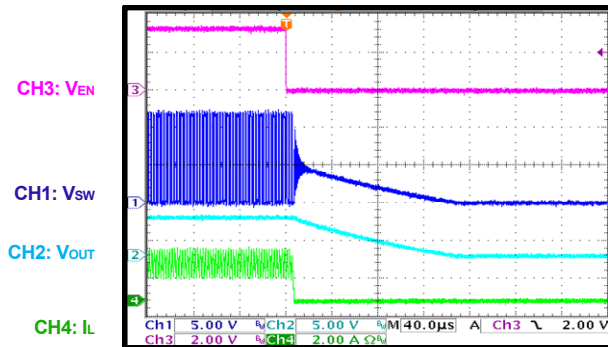

SCP Entry
 $I_{OUT} = 0A$, AAM

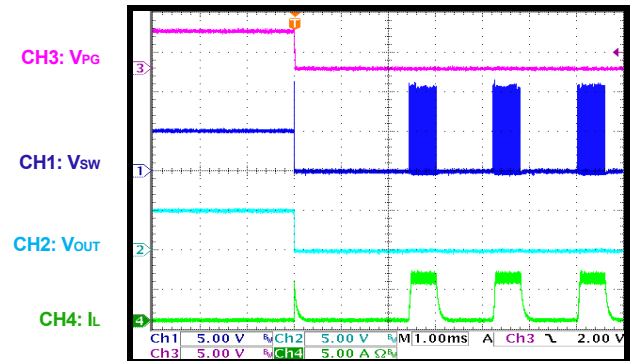

SCP Entry
 $I_{OUT} = 0A$, CCM

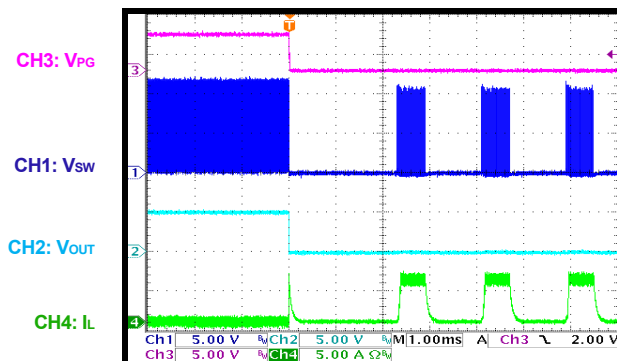

SCP Entry
 $I_{OUT} = 2A$

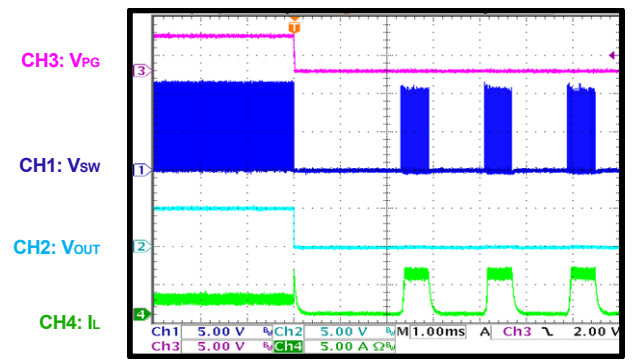

EVB TEST RESULTS (continued)

Performance curves and waveforms are tested on the evaluation board. $V_{IN} = 12V$, $V_{OUT} = 5V$, $L = 4.7\mu H$, $f_{sw} = 450kHz$, $T_A = 25^\circ C$, unless otherwise noted.

SCP Steady State

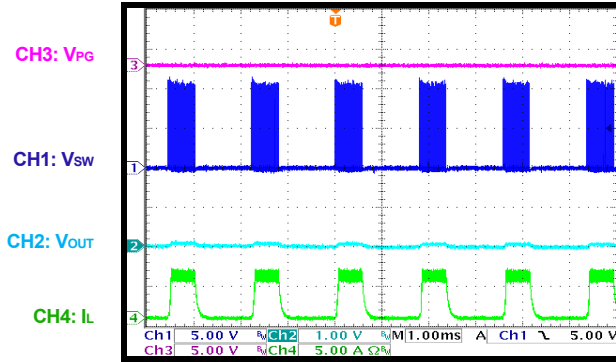

SCP Recovery

$I_{OUT} = 0A$, AAM

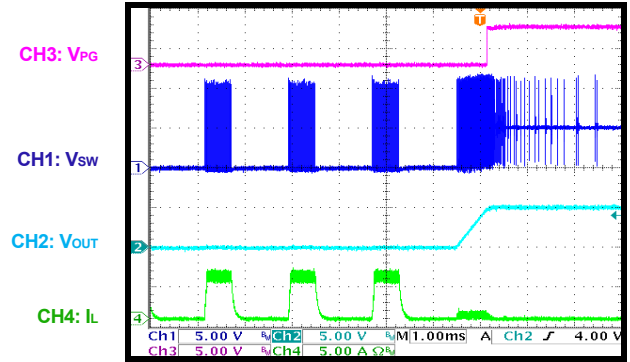

SCP Recovery

$I_{OUT} = 0A$, CCM

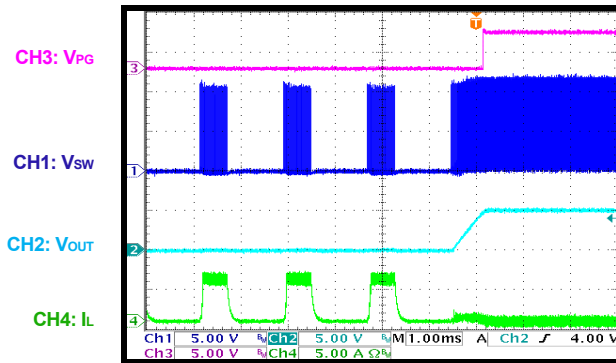

SCP Recovery

$I_{OUT} = 2A$

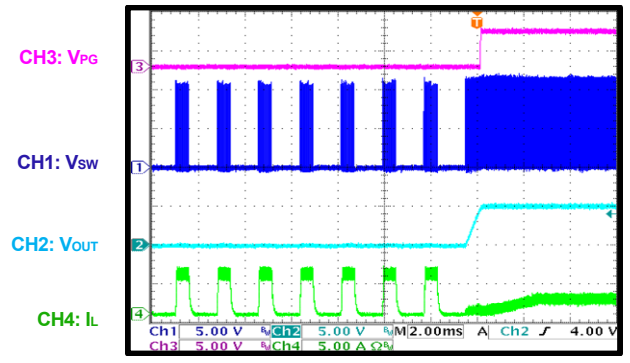

Load Transient

$V_{IN} = 12V$, $V_{OUT} = 5V$, $I_{OUT} = 1A$ to $2A$

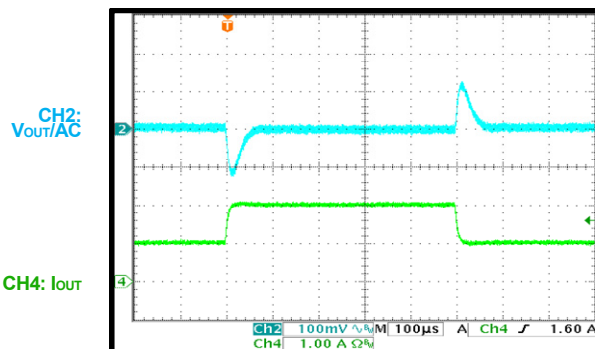

Cold-Crank Conditions

$V_{IN} = 12V$ to $3.3V$ to $5V$, $I_{OUT} = 0A$

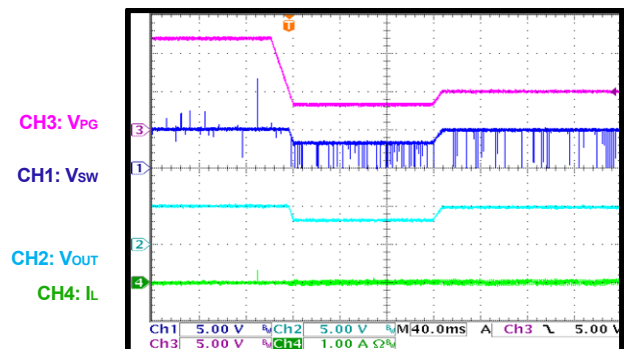

EVB TEST RESULTS (continued)

Performance curves and waveforms are tested on the evaluation board. $V_{IN} = 12V$, $V_{OUT} = 5V$, $L = 4.7\mu H$, $f_{sw} = 450kHz$, $T_A = 25^\circ C$, unless otherwise noted.

Cold-Crank Conditions

$V_{IN} = 12V$ to $3.3V$ to $5V$, $I_{OUT} = 2A$

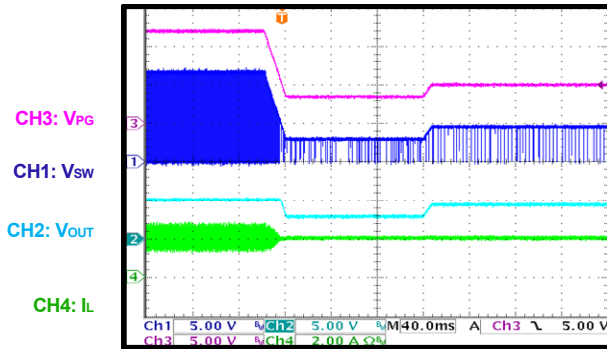

VIN Ramp Down and Up

$V_{IN} = 18V$ to $3.5V$ to $0V$ to $3.5V$ to $18V$, $I_{OUT} = 0A$

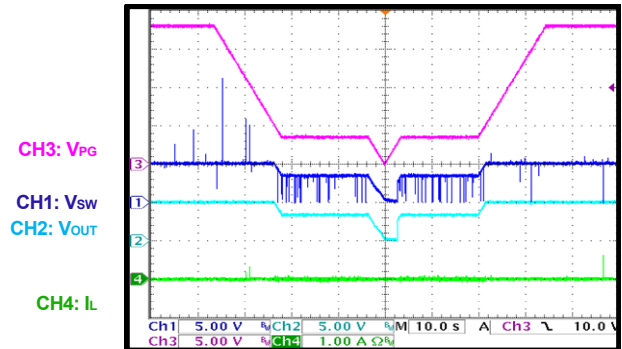

VIN Ramp Down and Up

$V_{IN} = 18V$ to $4V$ to $0V$ to $4V$ to $18V$, $I_{OUT} = 2A$

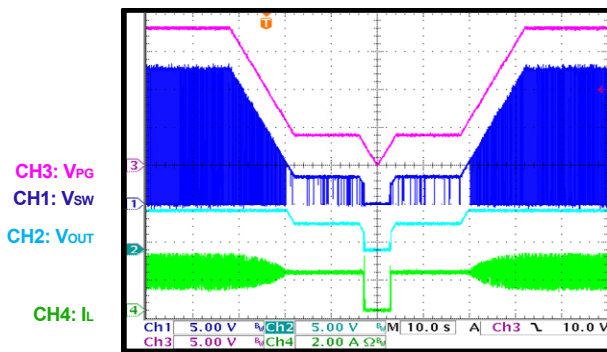

Load Dump

$V_{IN} = 12V$ to $36V$ to $12V$, $I_{OUT} = 2A$

