



EVQ5072-G-00A

1A, 5.5V, Low $R_{DS(ON)}$ Load Switch with Configurable Current Limit Evaluation Board, AEC-Q100 Qualified

DESCRIPTION

The EVQ5072-G-00A is an evaluation board designed to demonstrate the capabilities of the MPQ5072, a low $R_{DS(ON)}$ load switch with configurable current limiting. It can deliver up to 1A of continuous current across a wide input voltage range.

The MPQ5072's sense MOSFET topology allows the device to limit the maximum load output. The current limit is controlled by an external resistor connected from the ILIM pin to ground (GND).

The MPQ5072's ultra-small package and low $R_{DS(ON)}$ provide a highly efficient and space-saving solution for notebooks, tablets, and other portable device applications.

The EVQ5072-G-00A is a fully assembled and tested evaluation board. It generates 3V to 5.5V of output voltage (V_{OUT}) and 1A of continuous current across a wide 0.5V to 5.5V input range.

ELECTRICAL SPECIFICATIONS

Parameter	Symbol	Value	Units
Input voltage ⁽¹⁾	V_{IN}	0.8 to 5.5	V
Output voltage	V_{CC}	3 to 5.5	V
Output current	I_{OUT}	1	A

Note:

1) For lower voltage specifications, contact MPS.

FEATURES

- Wide 0.5V to 5.5V Operating Input Range
- Integrated 50m Ω Low $R_{DS(ON)}$ MOSFETs
- Configurable Start-Up Slew Rate
- 2.5A Configurable Current Limit
- <1 μ A Shutdown Current
- Power Good (PG) Indicator
- Output Discharge Function
- Enable (EN) Pin
- <200ns Short-Circuit Protection (SCP) Response Time
- Thermal Shutdown (TSD)
- Available in an Ultra-Small QFN-12 (2mmx2mm) Package
- AEC-Q100 Qualified

APPLICATIONS

- Notebook and Tablet Computers
- Portable Devices
- Solid-State Drives (SSDs)
- Handheld Devices

All MPS parts are lead-free, halogen-free, and adhere to the RoHS directive. For MPS green status, please visit the MPS website under Quality Assurance. "MPS", the MPS logo, and "Simple, Easy Solutions" are trademarks of Monolithic Power Systems, Inc. or its subsidiaries.

EVQ5072-G-00A EVALUATION BOARD



LxWxH (6.4cmx6.4cmx1.3cm)

Board Number	MPS IC Number
EVQ5072-G-00A	MPQ5072GG

R_{ON} vs. V_{CC}

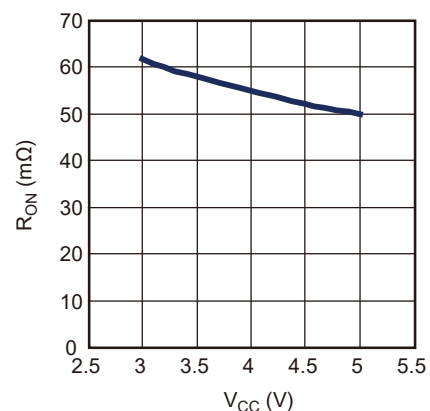

QUICK START GUIDE

1. Preset the power supply between 0.8V and 5.5V, then turn off the power supply.
2. Connect the power supply terminals to:
 - a. Positive (+): VIN
 - b. Negative (-): GND
3. Connect the load terminals to:
 - a. Positive (+): VOUT
 - b. Negative (-): GND
4. After making the connections, turn on the power supply. The board should automatically start up.
5. To use the enable (EN) function:
 - a. Apply a digital input to the EN pin.
 - b. Drive EN above 2.6V to turn the regulator on; drive EN below 0.4V to turn it off.
6. Set the output current limit with resistor R1. ⁽²⁾
7. Set the soft-start time with capacitor C4. ⁽²⁾
8. If V_{IN} drops below 3V, VCC requires a 3.6V power supply.
9. If using two input supplies, remove R2.

Note:

- 2) To select an appropriate R1 and C4, refer to the Application Information section of the MPQ5072 datasheet.

EVALUATION BOARD SCHEMATIC

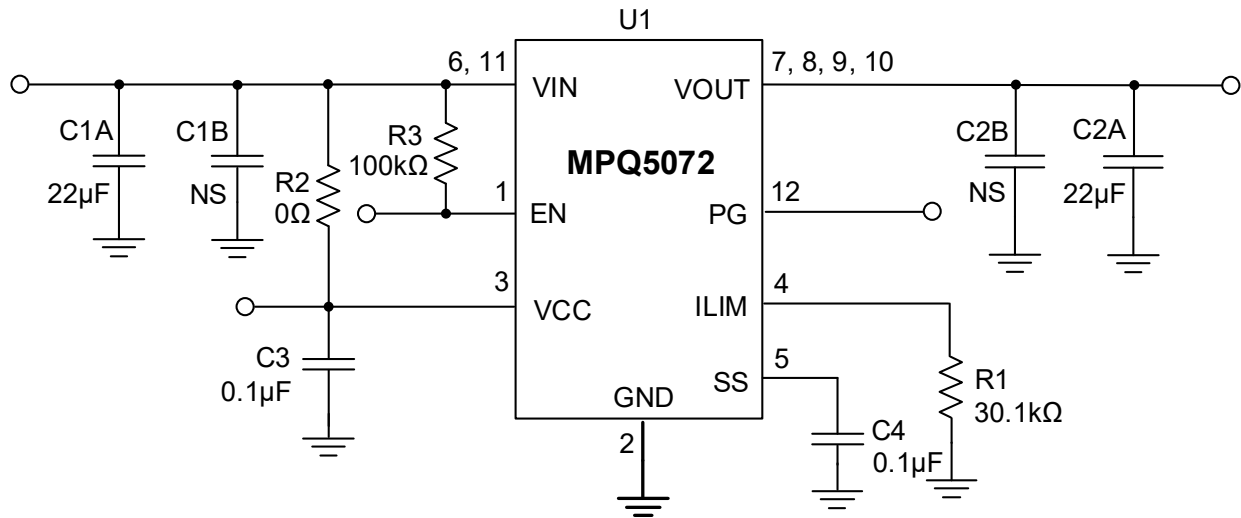

Figure 1: Evaluation Board Schematic

EVQ5072-G-00A BILL OF MATERIALS

Qty	Ref	Value	Description	Package	Manufacturer	Manufacturer P/N
2	C _{1A} , C _{2A}	22 μ F	Ceramic capacitor, 10V, X5R	0805	Murata	GRM21BR61A226ME44L
2	C _{1B} , C _{2B}	NS				
2	C ₃ , C ₄	100nF	Ceramic capacitor, 25V, X7R	0603	Murata	GRM188R71E104KA01D
1	R1	30.1k Ω	Resistor, 1%	0603	Any	RC0603FR-0730K1L
1	R2	0 Ω	Resistor, 5%	0603	Any	
1	R3	100k Ω	Resistor, 5%	0603	Any	
1	U1	MPQ5072	1A load switch	QFN-12 (2mmx2mm)	MPS	MPQ5072GG
2	PG, EN	1mm	Test point	DIP	Any	
4	VIN, GND, GND, VOUT	2mm	Test point	DIP	Any	

EVB TEST RESULTS

Performance waveforms are tested on the evaluation board. $V_{IN} = 3.6V$, $V_{CC} = 3.6V$, $EN = 2.5V$, $R_{LIM} = 13k\Omega$, $T_A = 25^\circ C$, unless otherwise noted.

Quiescent Current

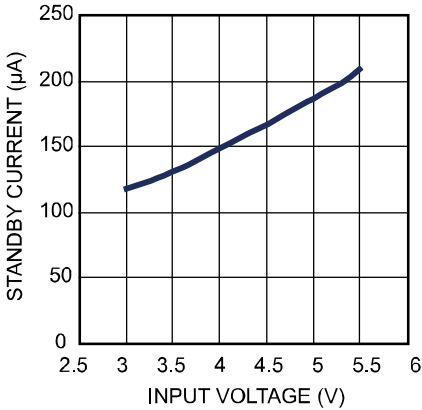

Disabled Supply Current vs. Input Voltage

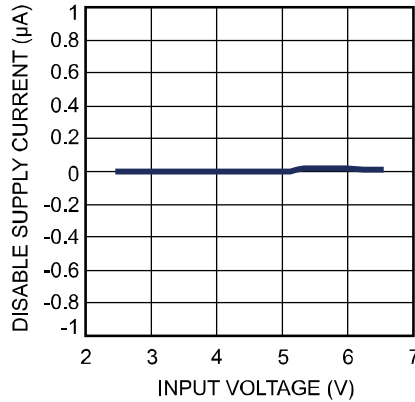

V_{IN} UVLO vs. Temperature

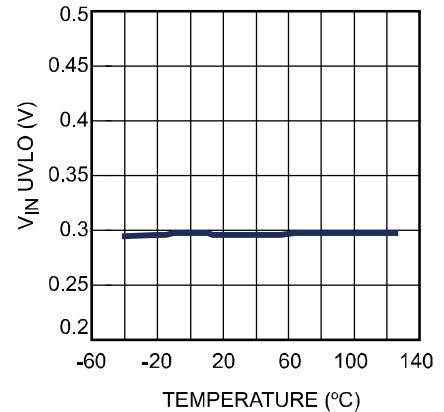

EN Rising Threshold vs. Temperature

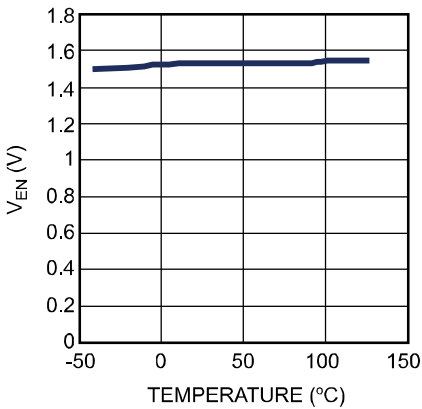

R_{ON} vs. V_{CC}

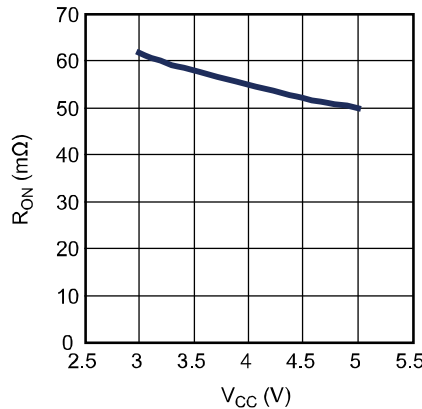

R_{ON} vs. Temperature

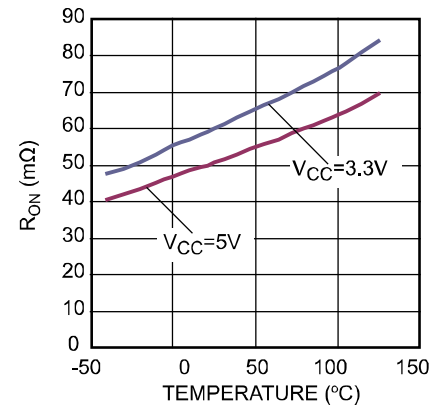

Maximum Current Limit vs. V_{IN}

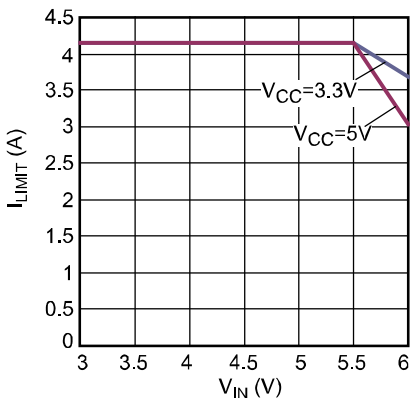

R_{LIMIT} vs. Current Limit

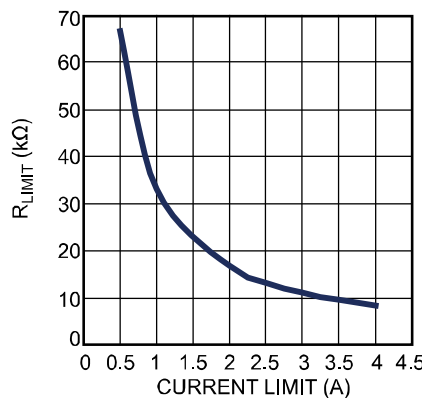

Soft-Start Time vs. Soft-Start Capacitance

$V_{IN} = 3.6V$

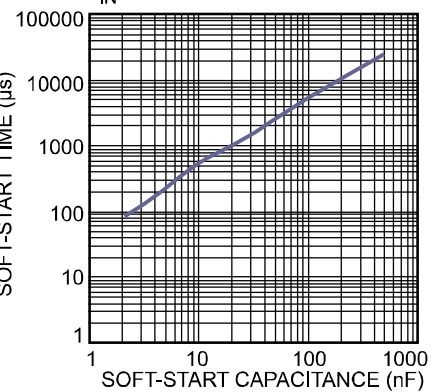

EVB TEST RESULTS *(continued)*

Performance waveforms are tested on the evaluation board. $V_{IN} = 3.6V$, $V_{CC} = 3.6V$, $EN = 2.5V$, $R_{ILIM} = 13k\Omega$, $T_A = 25^\circ C$, unless otherwise noted.

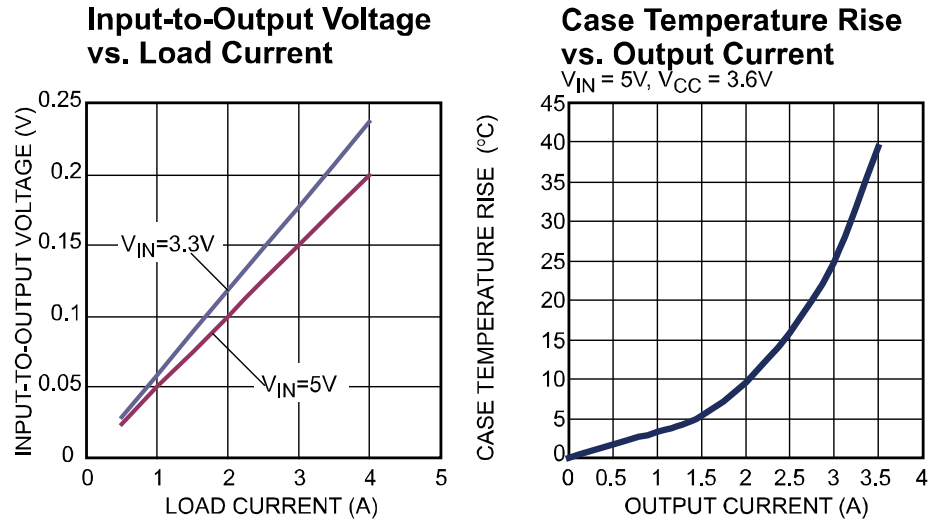

EVB TEST RESULTS (continued)

Performance waveforms are tested on the evaluation board. $V_{IN} = 3.6V$, $V_{CC} = 3.6V$, $EN = 2.5V$, $R_{ILIM} = 13k\Omega$, $T_A = 25^\circ C$, unless otherwise noted.

Start-Up through EN

$V_{IN} = 5V$, $V_{CC} = 3.6V$, no load

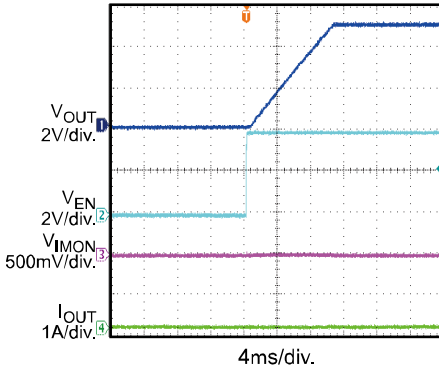

Start-Up through EN

$V_{IN} = 5V$, $V_{CC} = 3.6V$, 2A load

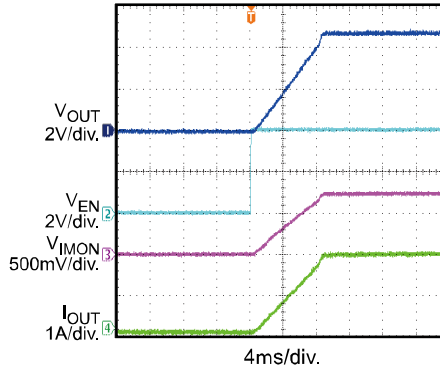

Shutdown through EN

$V_{IN} = 5V$, $V_{CC} = 3.6V$, no load

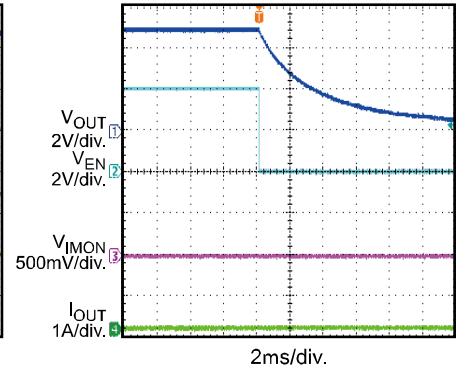

Shutdown through EN

$V_{IN} = 5V$, $V_{CC} = 3.6V$, 2A load

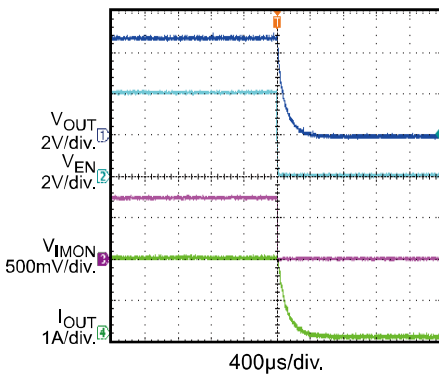

Start-Up

$V_{IN} = 5V$, $V_{CC} = 3.6V$, $I_{OUT} = 0A$

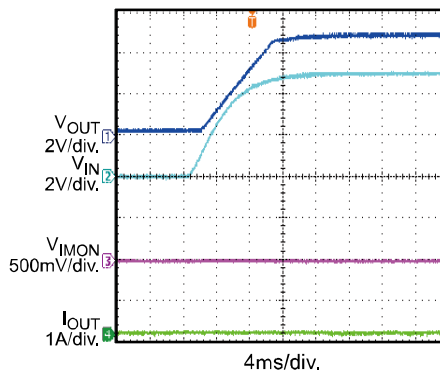

Start-Up

$V_{IN} = 5V$, $V_{CC} = 3.6V$, $I_{OUT} = 2A$

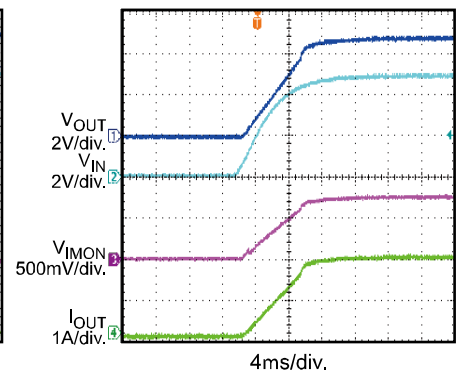

Shutdown

$V_{IN} = 5V$, $V_{CC} = 3.6V$, $I_{OUT} = 0A$

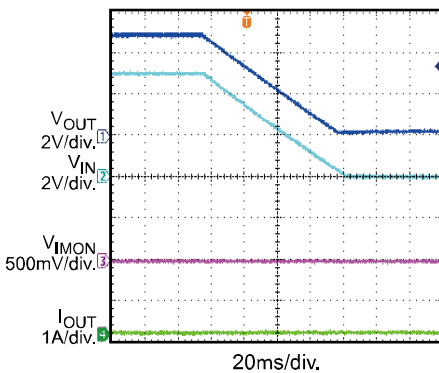

Shutdown

$V_{IN} = 5V$, $V_{CC} = 3.6V$, $I_{OUT} = 2A$

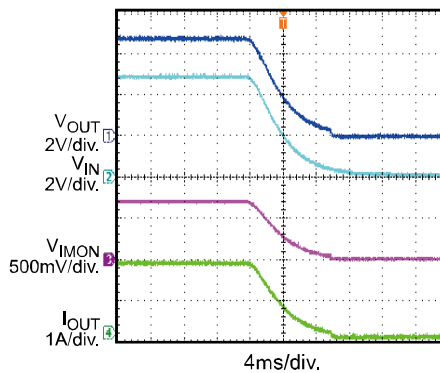

Steady State

$V_{IN} = 5V$, $V_{CC} = 3.6V$, $I_{OUT} = 2A$

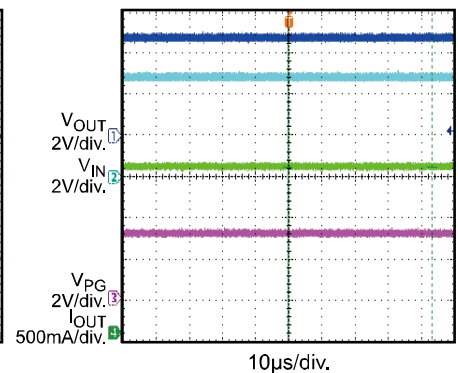

EVB TEST RESULTS *(continued)*

Performance waveforms are tested on the evaluation board. $V_{IN} = 3.6V$, $V_{CC} = 3.6V$, $EN = 2.5V$, $R_{ILIM} = 13k\Omega$, $T_A = 25^\circ C$, unless otherwise noted.

Load Transient Response

$V_{IN} = 3.6V$, $V_{CC} = 3.6V$, $I_{OUT} = 0A-2.5A$

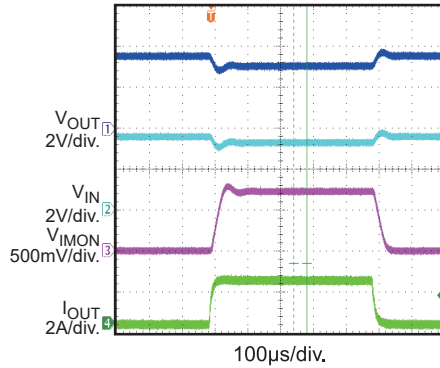

SCP Enter

$V_{IN} = 5V$, $V_{CC} = 3.6V$

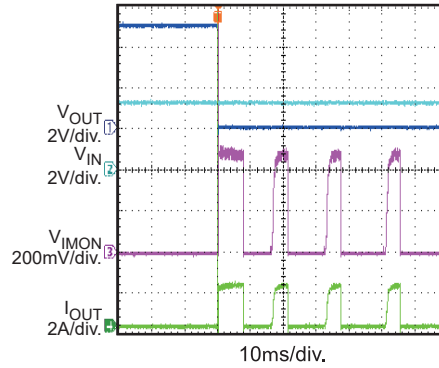

SCP Steady State

$V_{IN} = 5V$, $V_{CC} = 3.6V$

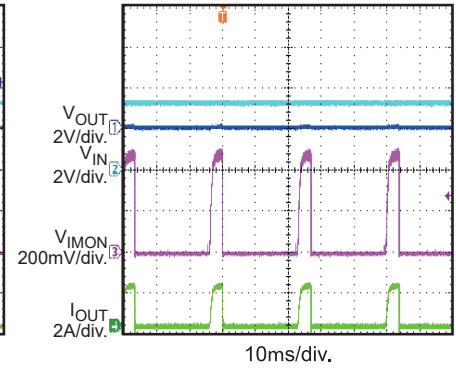

SCP Recovery

$V_{IN} = 5V$, $V_{CC} = 3.6V$

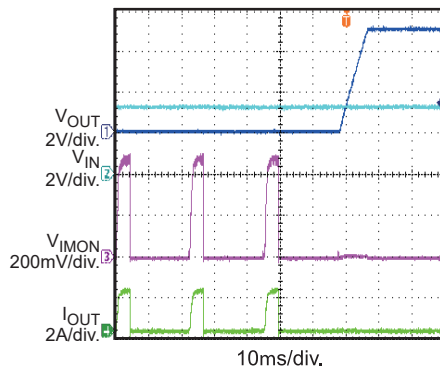

PCB LAYOUT

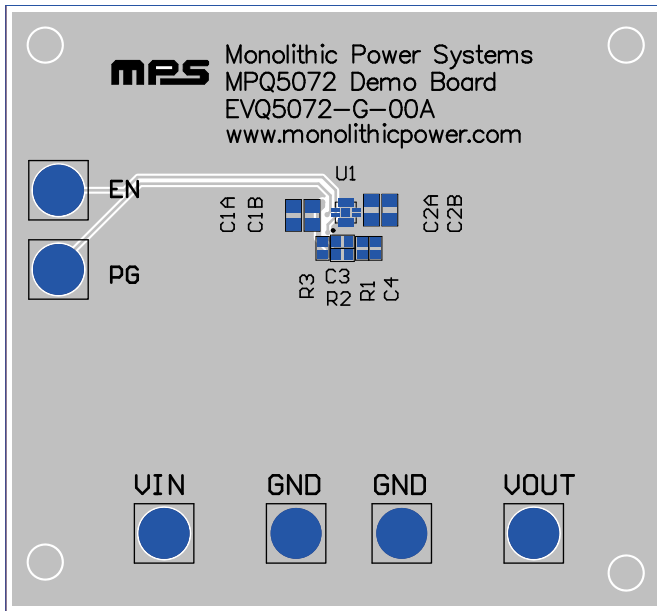

Figure 2: Top Silk

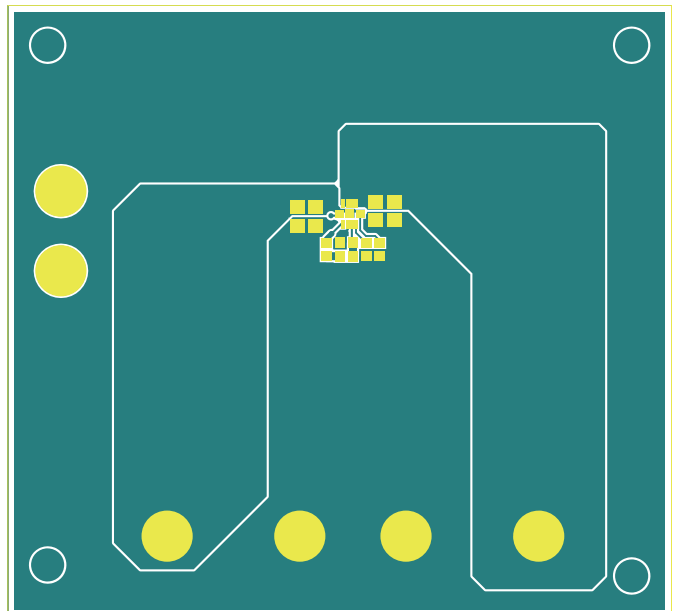

Figure 3: Top Layer

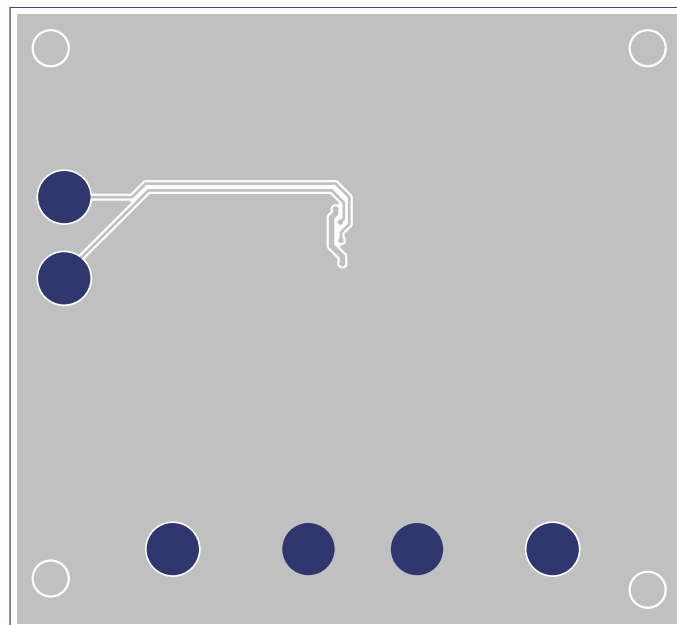

Figure 4: Bottom Layer