



# EVQ7220-R-00A

## 6-Channel, Max 100mA/Ch Boost LED Driver Evaluation Board

### DESCRIPTION

The EVQ7220-R-00A evaluation board is designed to demonstrate the capabilities of MPS's MPQ7220GR-AEC1.

The MPQ7220 is a boost converter with six channel current sources. It is designed for driving automotive tail lights.

The MPQ7220 uses peak current mode as its PWM control architecture. The switching frequency can be programmed by a resistor. It independently regulates the current in each LED string to the value set by an external current-setting resistor.

The EVQ7220-R-00A is a fully assembled and tested, boost LED driver evaluation board. It generates an LED current up to 100mA from a 3.5V to 36V input voltage range with a 450kHz switching frequency.

### ELECTRICAL SPECIFICATIONS

Parameter	Symbol	Value	Units
Input voltage	$V_{EMI}$	3.5 to 36	V
Output voltage	$V_{LED}$	<42	V
LED current/string	$I_{LED}$	100	mA
# LEDs	-	6 strings	-

### FEATURES

- 3.5V to 36V Input Voltage Range
- Six Channels with Max 100mA per Channel
- Internal 100mΩ, 50V MOSFET
- Configurable  $f_{sw}$  Up to 2.2MHz
- External Sync SW Function
- PWM Dimming (100Hz to 20kHz Dimming Frequency)
- Excellent EMI Performance, Spread Spectrum
- Disconnect  $V_{OUT}$  from  $V_{IN}$
- 2.5% Current Matching
- Cycle-by-Cycle Current Limiting
- Configurable LED Short and OVP Thresholds
- LED Current Auto-Decrement at High Temperatures
- Protections: LED Short/Open, OTP, OCP, Inductor Short, Fault Indicator Signal Output
- Available in a QFN-24 (4mmx4mm) Package
- Available in AEC-Q100 Grade 1

### APPLICATIONS

- Automotive Tail Lights

All MPS parts are lead-free, halogen free, and adhere to the RoHS directive. For MPS green status, please visit the MPS website under Quality Assurance. "MPS", the MPS logo, and "Simple, Easy Solutions" are registered trademarks of Monolithic Power Systems, Inc. or its subsidiaries.

## EVQ7220-R-00A EVALUATION BOARD



(LxWxH) 8.3cmx8.3cmx2cm

Board Number	MPS IC Number
EVQ7220-R-00A	MPQ7220GR-AEC1

### Efficiency vs. Input Voltage

$V_{LED} = 34V$ ,  $I_{LED} = 6 \times I_{SET}$

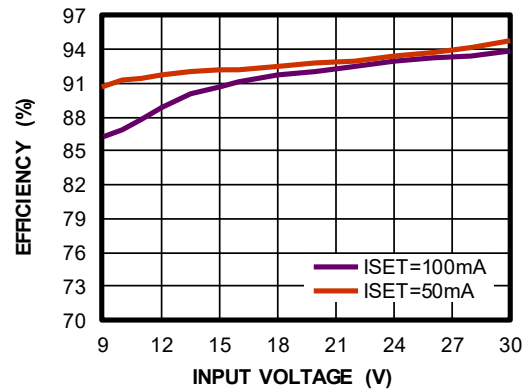

## QUICK START GUIDE

1. Provide a voltage source between 3.5V and 36V between the VEMI terminal and GND.
2. If longer cables (>0.5m total) are used between the source and the EVB, install a damping capacitor at the input terminals. This is critical when  $V_{EMI}$  exceeds 24V.
3. Connect the LED load terminals to:
  - a. Positive (+): LED+
  - b. Negative (-): LED1~6
4. Drive EN above 1.2V to turn on the driver; drive EN below 0.4V to turn it off.
5. Apply a 100Hz to 20kHz PWM signal on the DIM pin for brightness control. Drive the DIM pin above 1.2V if the dimming function not used.
6. Calculate the LED current amplitude setting ( $I_{LED}$ ) with Equation (1):

$$I_{LED} \text{ (mA)} = \frac{1245}{R_{ISET} \text{ (k}\Omega\text{)}} \quad (1)$$

For  $R_{ISET} = 12.4\text{k}\Omega$ ,  $I_{LED}$  is 100mA.

7. The voltage divider sets the over-voltage protection (OVP) point (see Figure 1 on page 3). Calculate the OVP voltage ( $V_{OVP}$ ) with Equation (2):

$$V_{OVP} \text{ (V)} = 2\text{V} \times \frac{R_{I1} + R_{I2}}{R_{I2}} \quad (2)$$

The OVP point is typically set about 10% to 30% above the LED voltage.

8. The frequency can be configured via an external resistor or an external clock on the FREQ/SYNC pin. Calculate the switching frequency ( $f_{SW}$ ) using Equation (3):

$$f_{SW} \text{ (kHz)} = \frac{22000}{R_{FRE} \text{ (k}\Omega\text{)}} \quad (3)$$

For  $R_{FRE} = 48.7\text{k}\Omega$ ,  $f_{SW}$  is set to 450kHz.

### EVALUATION BOARD SCHEMATIC

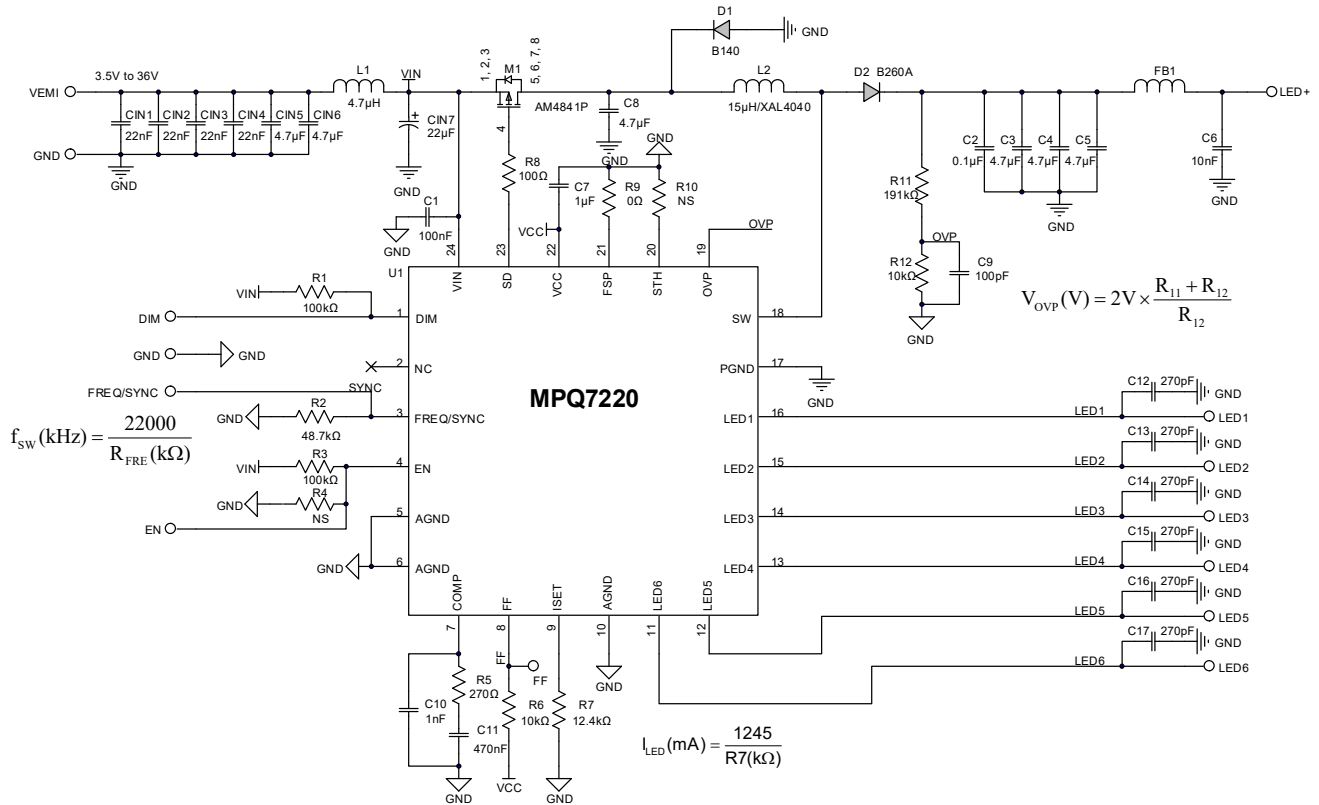
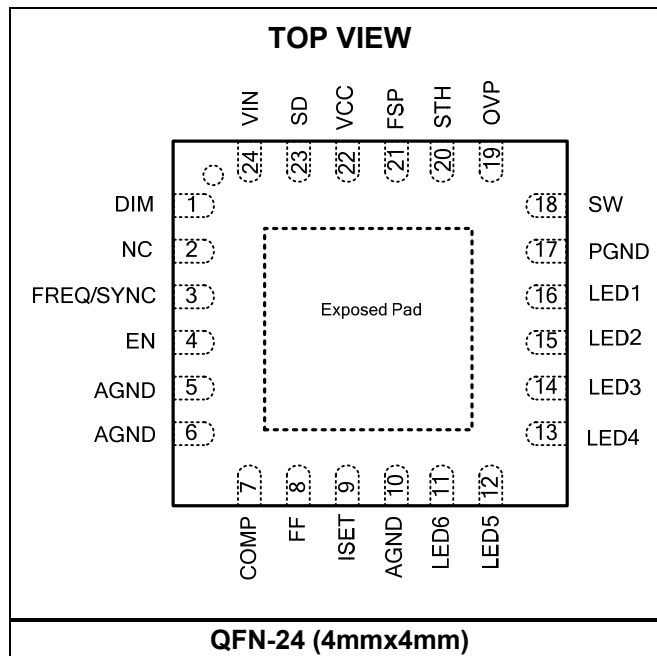

Figure 1: Evaluation Board Schematic

### PACKAGE REFERENCE



**EVQ7220-R-00A BILL OF MATERIALS**

Qty	Ref	Value	Description	Package	Manufacturer	Manufacturer PN
4	CIN1, CIN2, CIN3, CIN4	22nF	Ceramic capacitor, 50V, X7R	0603	Murata	GRM188R71H223KA01D
5	CIN5, CIN6, C3, C4, C5	4.7µF	Ceramic capacitor, 50V, X7S	0805	Murata	GRM21BC71H475KE11L
1	CIN7	22µF	Electrolytic capacitor, 50V	SMD	Panasonic	EEHZC1H220P
2	C1, C2	100nF	Ceramic capacitor, 50V, X7R	0603	Murata	GCM188R71H104KA57D
1	C6	10nF	Ceramic capacitor, 50V, X7R	0805	TDK	C2012X7R1H103K
1	C7	1µF	Ceramic capacitor, 16V, X7R	0805	Murata	GRM21BR71C105KA01
1	C8	4.7µF	Ceramic capacitor, 50V, X7R	1210	Murata	GCM32ER71H475KA55L
1	C9	100pF	Ceramic capacitor, 50V, C0G	0603	Murata	GRM1885C1H101JA01D
1	C10	1nF	Ceramic capacitor, 50V, C0G	0603	Murata	GRM1885C1H102JA01D
1	C11	470nF	Ceramic capacitor, 16V, X7R	0603	Murata	GRM188R71C474KA88D
6	C12, C13, C14, C15, C16, C17	270pF	Ceramic capacitor, 50V, C0G	0603	Murata	GRM1885C1H271JA01D
1	D1	1A	Schottky diode, 40V	SMA	Diodes, Inc.	B140-13-F
1	D2	2A	Schottky diode, 60V	SMA	Diodes, Inc.	B260A-13-F
1	L1	4.7µH	Inductor, 150mΩ, 2.5A	SMD	Cyntec	VCTA32251B-4R7MS6-89
1	L2	15µH	Inductor, 120mΩ, 2.8A	SMD	Coilcraft	XAL4040-153MEB
1	FB1	1.1A	Magnetic Bead, 1000	0805	Murata	BLM21SP102SN1
1	M1	-40V	P-Channel MOSFET	SO-8	Analog Power	AM4841P
2	R1, R3	100kΩ	Film resistor, 1%	0603	Yageo	RC0603FR-07100KL
1	R2	48.7kΩ	Film resistor, 1%	0603	Yageo	RC0603FR-0748K7L
1	R4	NS				
1	R5	270 Ω	Film resistor, 1%	0603	Yageo	RC0603FR-07270RL
2	R6, R12	10kΩ	Film resistor, 1%	0603	Yageo	RC0603FR-0710KL
1	R7	12.4kΩ	Film resistor, 1%	0603	Yageo	RC0603FR-0712K4L
1	R8	100Ω	Film resistor, 1%	0603	Yageo	RC0603FR-07100RL
1	R9	0 Ω	Film resistor, 1%	0603	Yageo	RC0603FR-070RL
1	R10	NS				
1	R11	191kΩ	Film resistor, 1%	0603	Yageo	RC0603FR-07191KL

**EVQ7220-R-00A BILL OF MATERIALS (continued)**

Qty	Ref	Value	Description	Package	Manufacturer	Manufacturer PN
1	U1	MPQ7220	6-channel boost LED driver	QFN-24 (4mmx4mm)	MPS	MPQ7220GR-AEC1
2	VEMI, GND	2mm	Golden pin	Terminal	Custom	
13	DIM, SYNC, EN, FF, GND, LED1-LED6, LED+	2.54mm	13-header test pin	Header	Custom	

## EVB TEST RESULTS

Performance curves and waveforms are tested on the evaluation board.  $V_{IN} = 12V$ ,  $L = 15\mu H$ , LED = 6P12S,  $f_{SW} = 450kHz$ ,  $I_{SET} = 100mA$ ,  $T_A = 25^\circ C$ , unless otherwise noted.

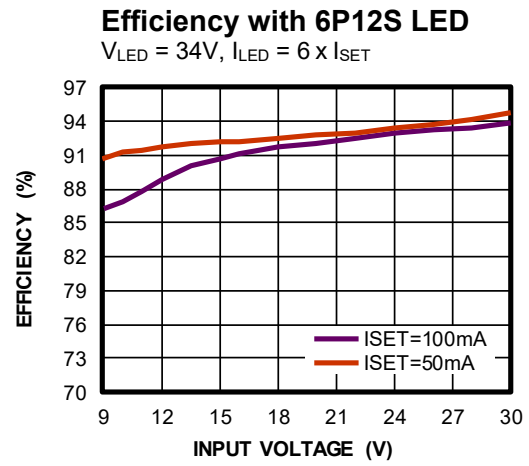
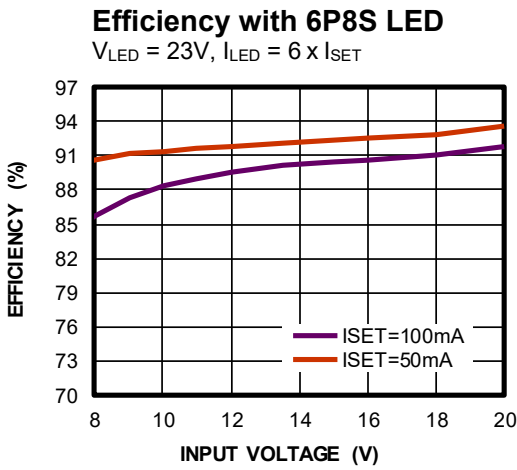

## EVB TEST RESULTS (continued)

Performance curves and waveforms are tested on the evaluation board.  $V_{IN} = 12V$ ,  $L = 15\mu H$ , LED = 6P12S,  $f_{SW} = 450kHz$ ,  $I_{SET} = 100mA$ , with EMI filters,  $T_A = 25^\circ C$ , unless otherwise noted.

### CISPR25 Class 5 Peak Conducted Emissions

150kHz to 108MHz

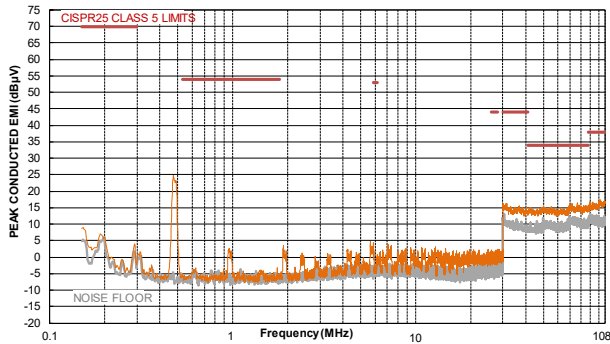

### CISPR25 Class 5 Average Conducted Emissions

150kHz to 108MHz

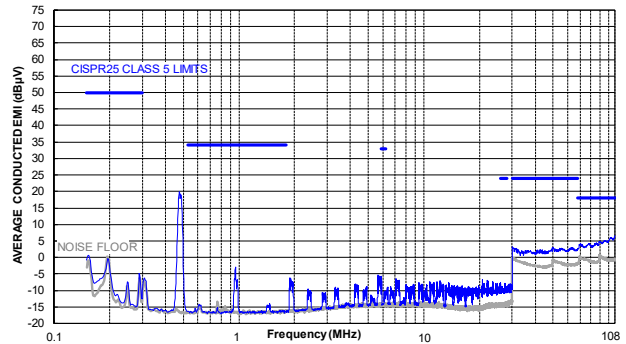

### CISPR25 Class 5 Peak Radiated Emissions

150kHz to 30MHz

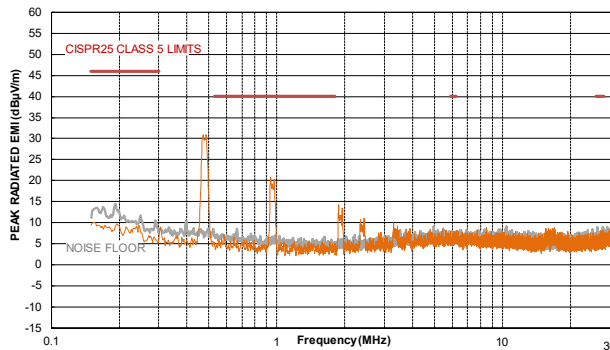

### CISPR25 Class 5 Average Radiated Emissions

150kHz to 30MHz

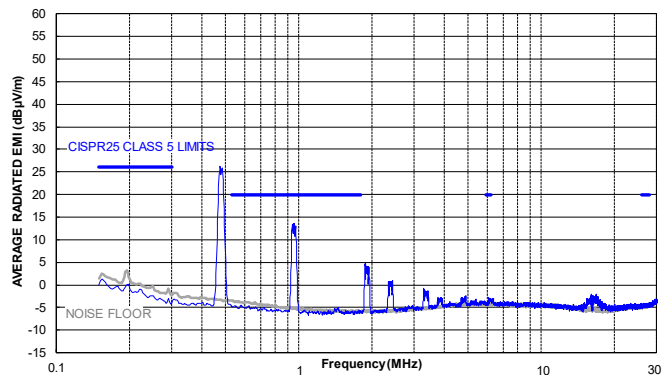

### CISPR25 Class 5 Peak Radiated Emissions

Horizontal, 30MHz to 200MHz

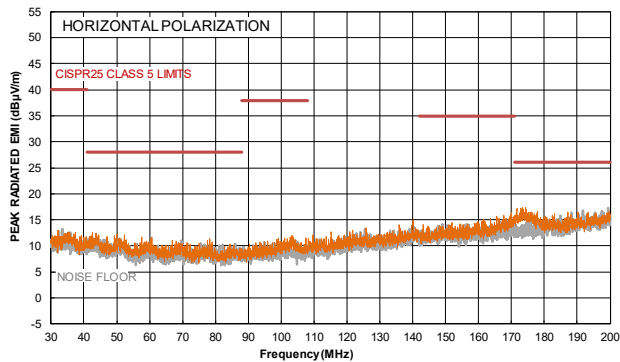

### CISPR25 Class 5 Average Radiated Emissions

Horizontal, 30MHz to 200MHz

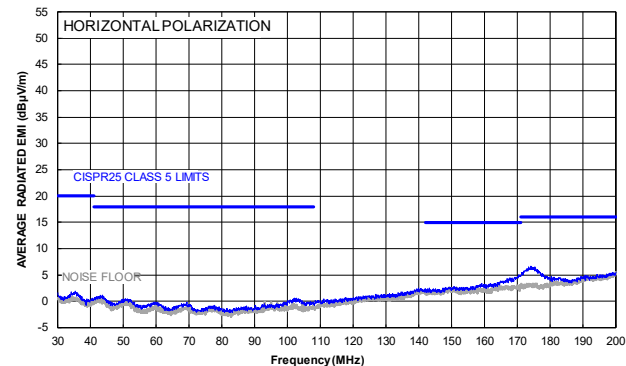

## EVB TEST RESULTS (continued)

Performance curves and waveforms are tested on the evaluation board.  $V_{IN} = 12V$ ,  $L = 15\mu H$ , LED = 6P12S,  $f_{SW} = 450kHz$ ,  $I_{SET} = 100mA$ , with EMI filters,  $T_A = 25^\circ C$ , unless otherwise noted.

### CISPR25 Class 5 Peak Radiated Emissions

Vertical, 30MHz to 200MHz

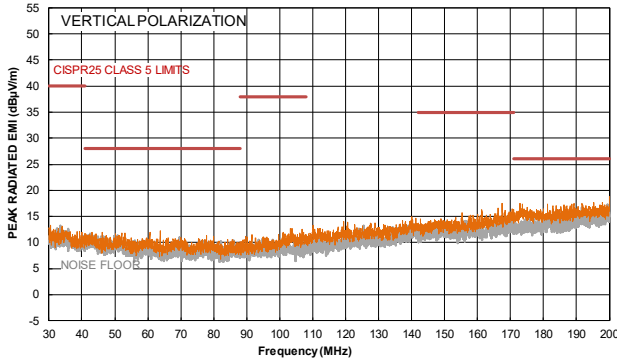

### CISPR25 Class 5 Average Radiated Emissions

Vertical, 30MHz to 200MHz

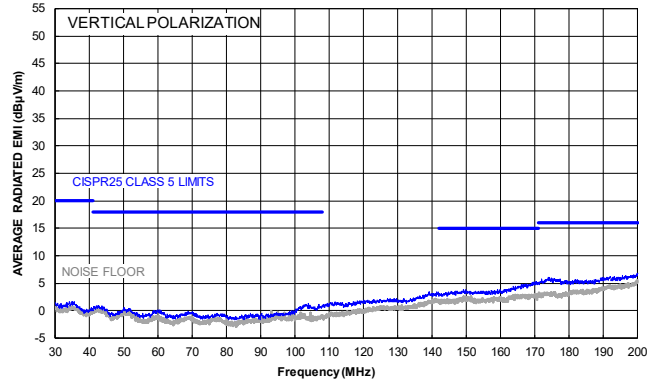

### CISPR25 Class 5 Peak Radiated Emissions

Horizontal, 200MHz to 1GHz

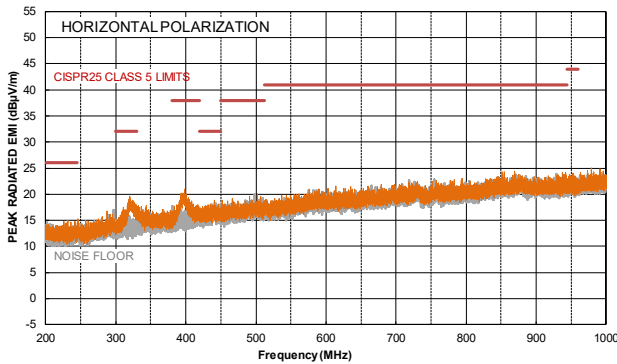

### CISPR25 Class 5 Average Radiated Emissions

Horizontal, 200MHz to 1GHz

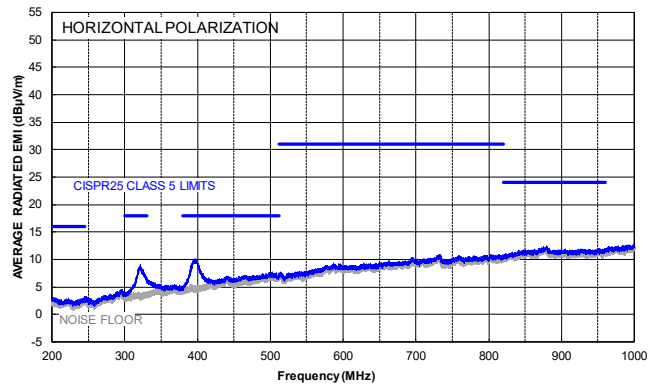

### CISPR25 Class 5 Peak Radiated Emissions

Vertical, 200MHz to 1GHz

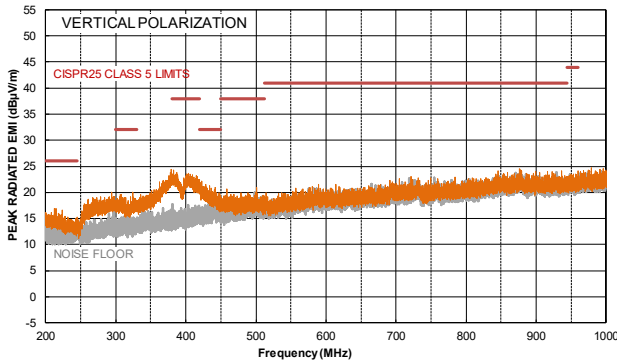

### CISPR25 Class 5 Average Radiated Emissions

Vertical, 200MHz to 1GHz

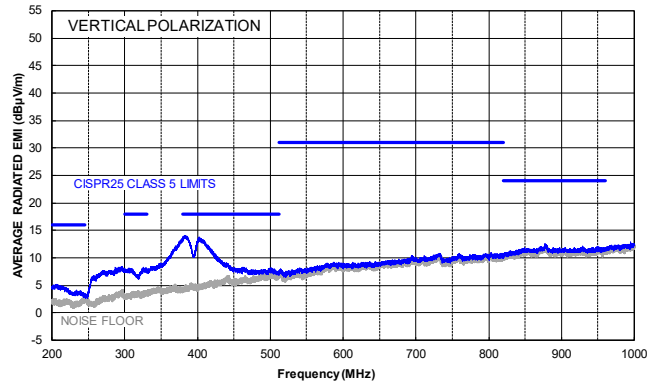



### EVB TEST RESULTS (continued)

Performance curves and waveforms are tested on the evaluation board.  $V_{IN} = 12V$ ,  $L = 15\mu H$ , LED = 6P12S,  $f_{sw} = 450kHz$ ,  $I_{SET} = 100mA$ ,  $T_A = 25^\circ C$ , unless otherwise noted.

#### Steady State

$I_{SET} = 100mA$

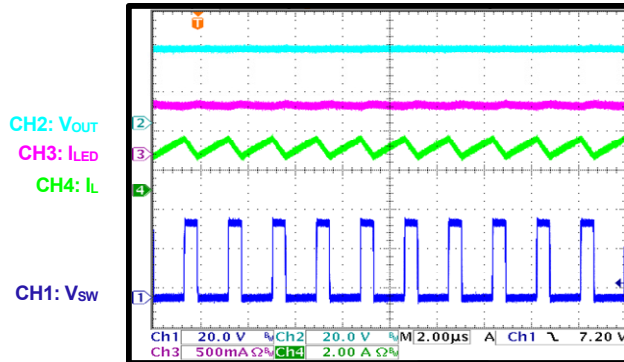

#### Frequency Spread Spectrum

1/20 of the center frequency

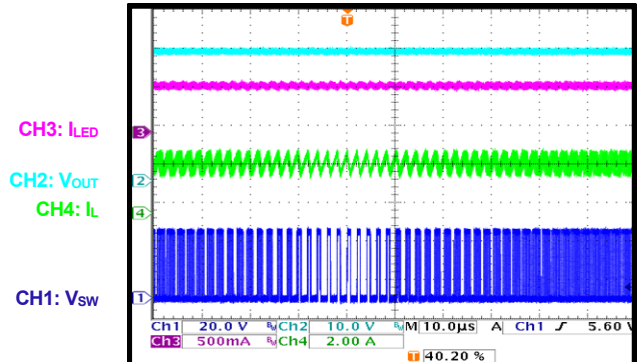

#### Start-Up through VIN

$I_{SET} = 100mA$

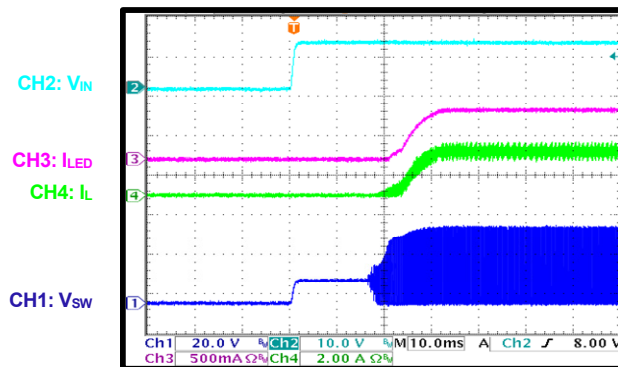

#### Shutdown through VIN

$I_{SET} = 100mA$

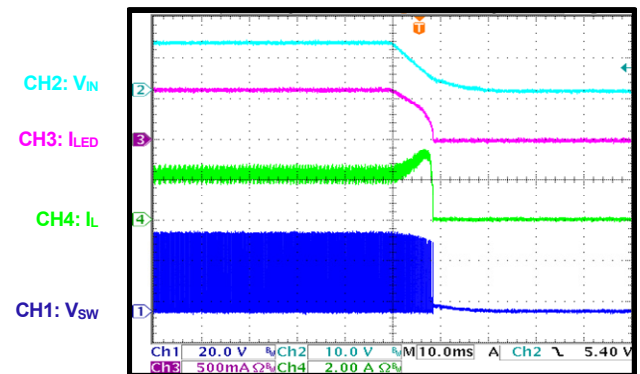

#### Start-Up through EN

$I_{SET} = 100mA$

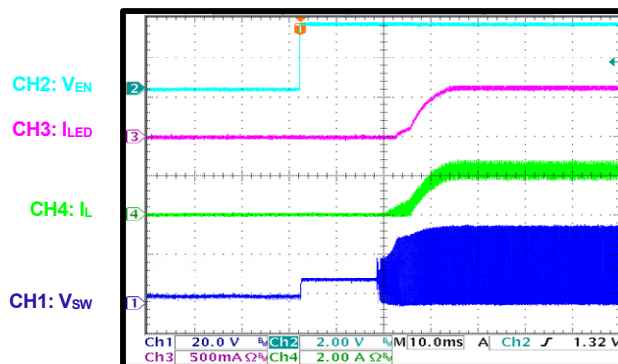

#### Start-Up through EN

$I_{SET} = 100mA$

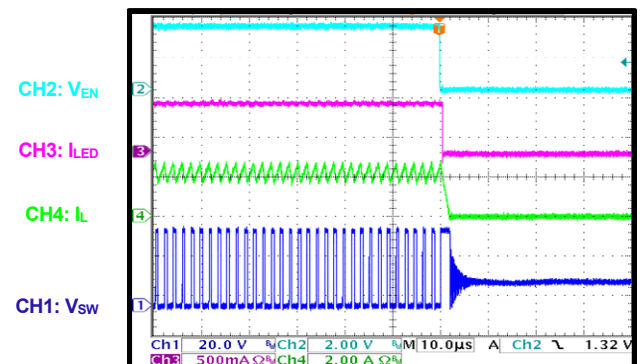

### EVB TEST RESULTS (continued)

Performance curves and waveforms are tested on the evaluation board.  $V_{IN} = 12V$ ,  $L = 15\mu H$ ,  $LED = 6P12S$ ,  $f_{SW} = 450kHz$ ,  $I_{SET} = 100mA$ ,  $T_A = 25^\circ C$ , unless otherwise noted.

**PWM Dimming Steady State**  
Dimming frequency = 100Hz

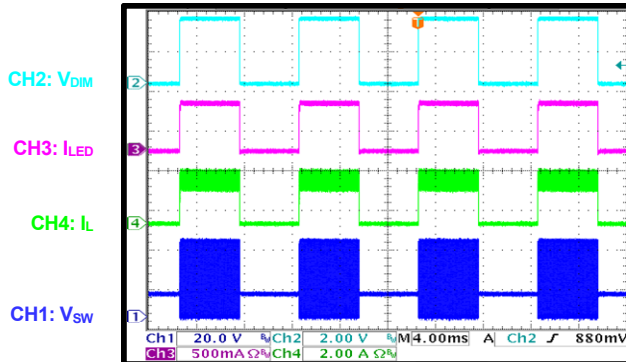

**PWM Dimming Steady State**  
Dimming frequency = 2kHz

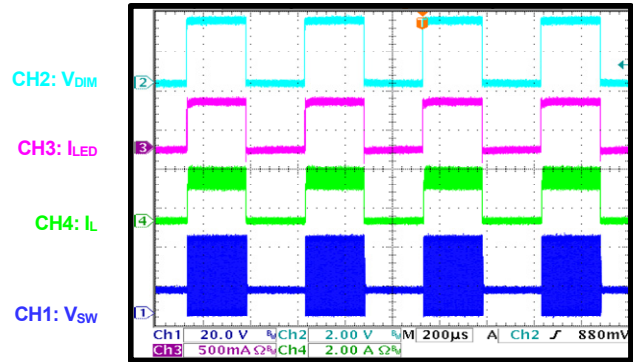

**PWM Dimming Start-Up through VIN**

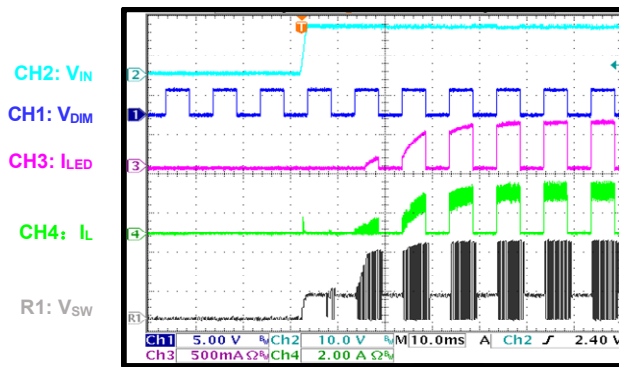

**PWM Dimming Shutdown through VIN**

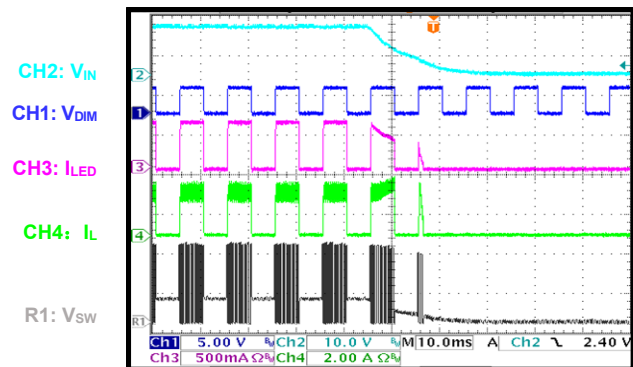

**PWM Dimming On**

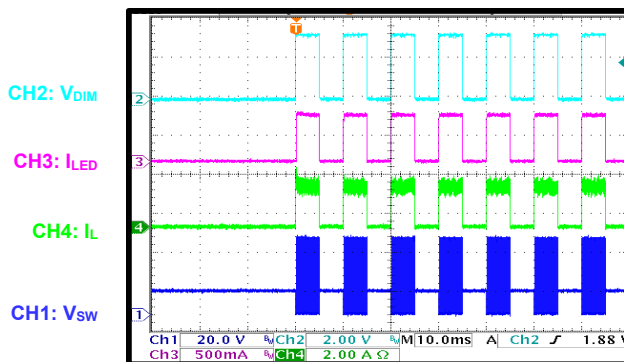

**PWM Dimming Off**

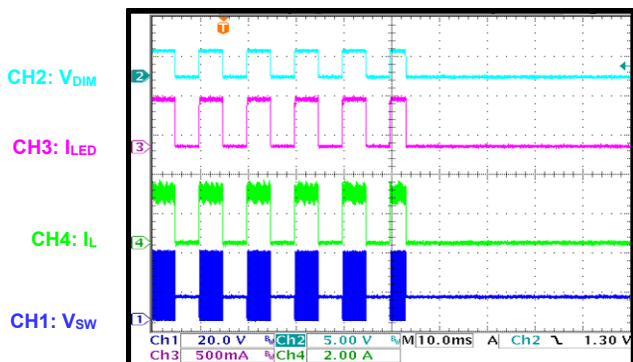

## EVB TEST RESULTS (continued)

Performance curves and waveforms are tested on the evaluation board.  $V_{IN} = 12V$ ,  $L = 15\mu H$ , LED = 6P12S,  $f_{SW} = 450kHz$ ,  $I_{SET} = 100mA$ ,  $T_A = 25^\circ C$ , unless otherwise noted.

### All 6 Strings LED Open Power On

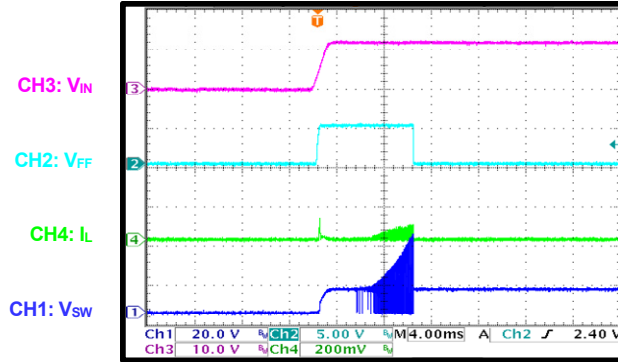

### All 6 Strings LED Open Entry

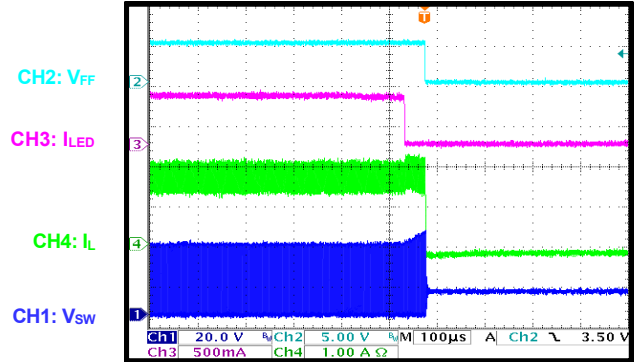

### 1 String LED Open Entry

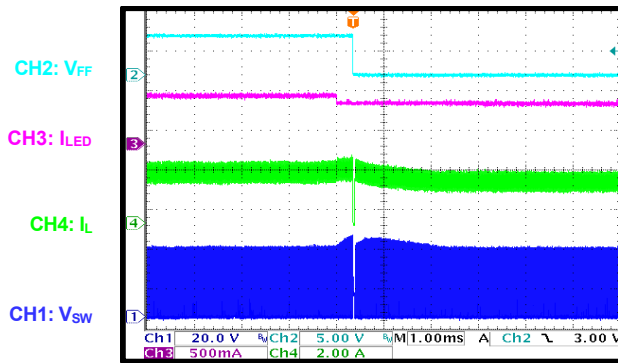

### 1 String LED Open Recovery

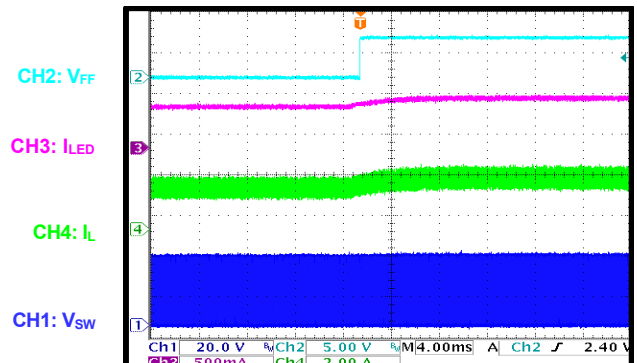

### V<sub>OUT</sub> Short to LEDx Steady State

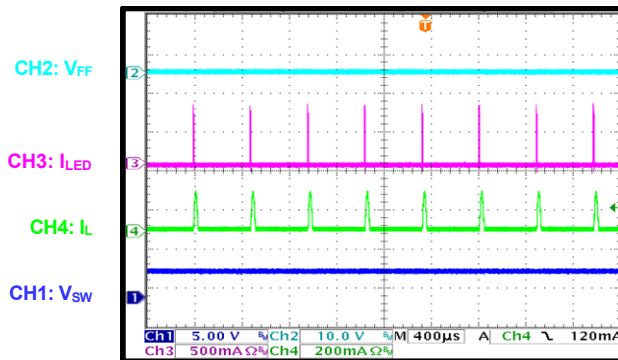

### V<sub>OUT</sub> Short to LEDx Entry

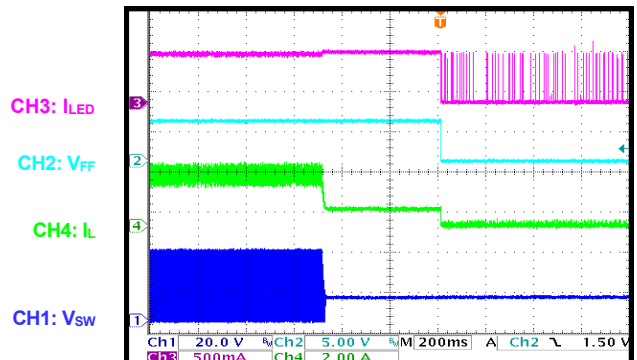

## EVB TEST RESULTS *(continued)*

Performance curves and waveforms are tested on the evaluation board.  $V_{IN} = 12V$ ,  $L = 15\mu H$ , LED = 6P12S,  $f_{SW} = 450kHz$ ,  $I_{SET} = 100mA$ ,  $T_A = 25^\circ C$ , unless otherwise noted.

### $V_{OUT}$ Short to LEDx Recovery

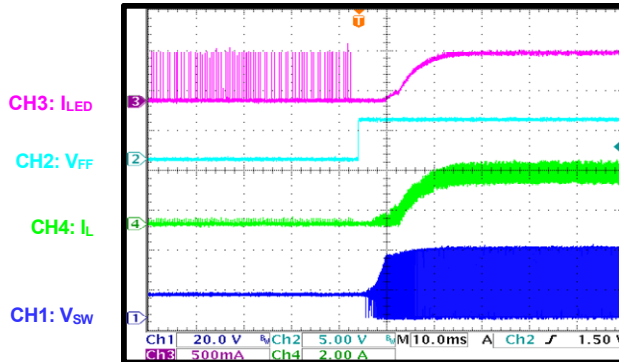

### $V_{OUT}$ Short to LED1 Entry

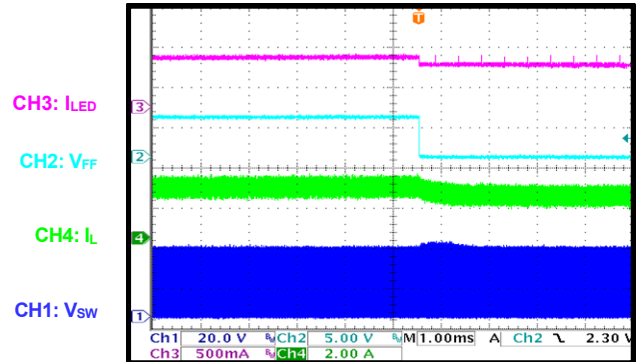

### $V_{OUT}$ Short to LED1 Recovery

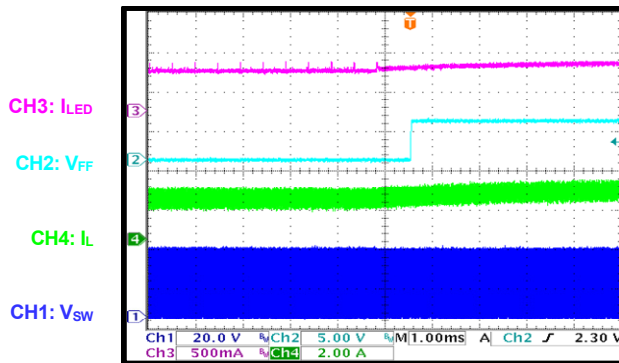

### LEDx Short to GND Entry

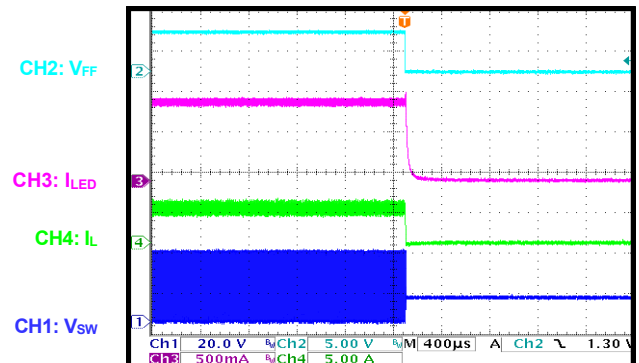

### Inductor Short Entry

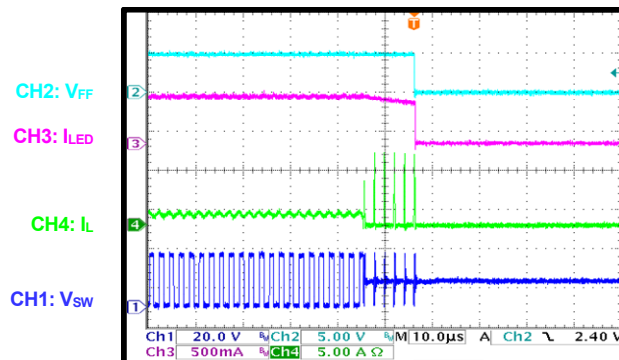

## PCB LAYOUT

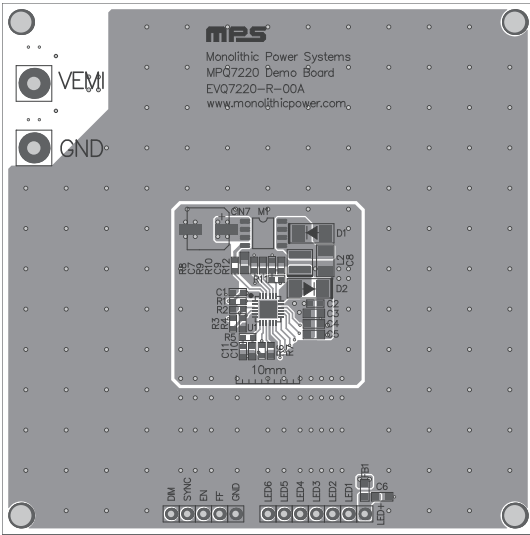

Figure 2: Top Silk Layer and Top Layer

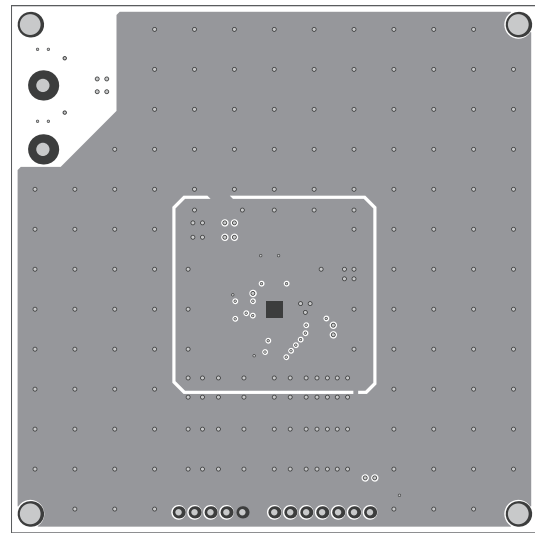

Figure 3: Mid-Layer 1

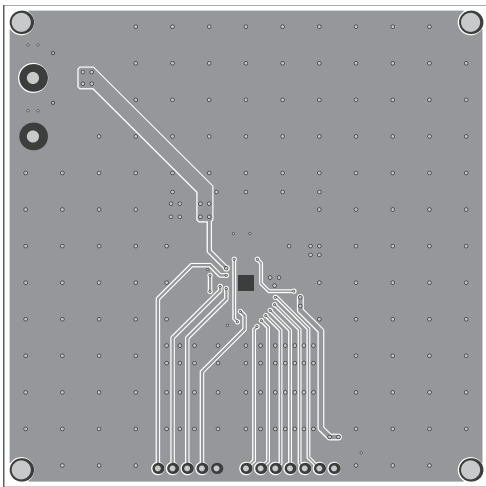

Figure 4: Mid-Layer 2

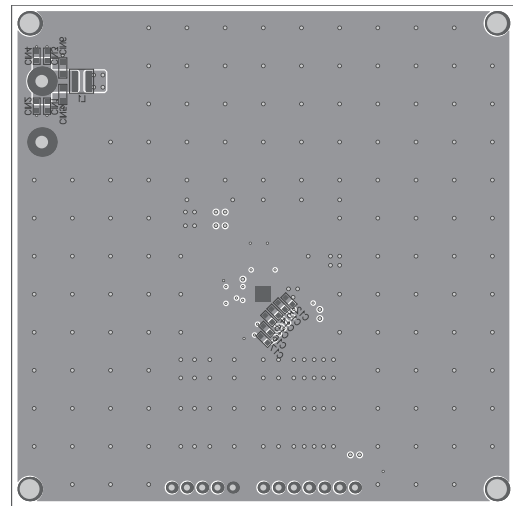

Figure 5: Bottom Layer and Bottom Silk