

GENERAL DESCRIPTION

This document describes the specifications for the IDTF1100 Zero-Distortion™ RF to IF Downconverting Mixer. This device is part of a series of downconverting mixers covering all UTRA bands. See the Part# Matrix for the details of all devices in the series.

The F1100 dual channel device operates with a single 5V supply. It is optimized for operation in a Multi-carrier BaseStation Receiver for RF bands from 698 to 915 MHz with High Side Injection. IF frequencies from 150 to 450 MHz are supported. Nominally, the device offers +41 dBm Output IP3 with 350 mA of I_{CC} .

COMPETITIVE ADVANTAGE

In typical basestation receivers the mixer limits the linearity performance for the entire receive system. The F1100 with Zero-Distortion technology dramatically improves the maximum IM_3 interference that the BTS can withstand at a desired Signal to Noise Ratio (SNR.)

- ✓ $IP3_O$: \uparrow 7 dB
- ✓ Allows for higher RF gain improving **Sensitivity**

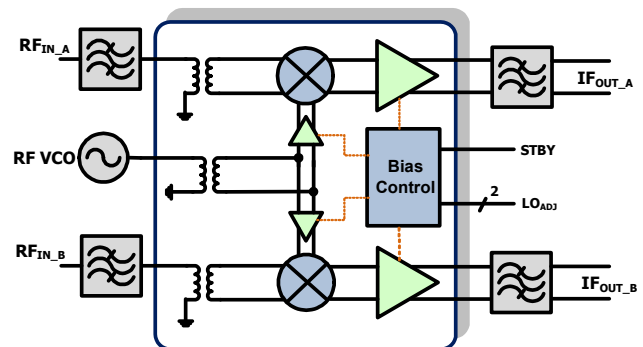

FEATURES

- Dual Path for Diversity Systems
- Ideal for Multi-Carrier Systems
- MIMO friendly: -6 dBm min LO drive
- 9 dB Gain
- Ultra linear: +41 dBm $IP3_O$ (350 MHz IF)
- Low NF ~10 dB
- 200 Ω output impedance
- Ultra high +13 dBm $P1dB_I$
- Pin Compatible w/Existing solutions
- 6x6 36 pin package
- Power Down mode
- Standard Mode: $I_{CC} = 350$ mA

DEVICE BLOCK DIAGRAM

PART# MATRIX

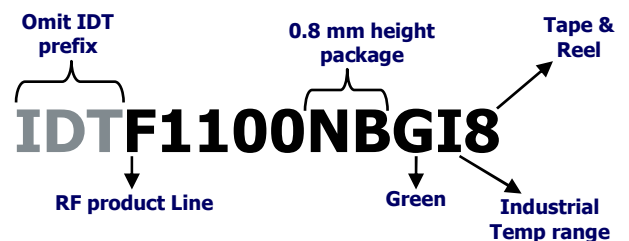
Part#	RF freq range	UTRA bands	IF freq range	Typ. Gain	Injection
F1100	698 - 915	5,6,8,12,13,14,17,19,20	150 - 450	9	High Side
F1102	400 - 1000	5,6,8,12,13,14,17,19,20	50 - 300	9.0	Both
F1150	1700 - 2200	1,2,3,4,9,10,33,34,35,36,37,39	50 - 450	8.5	High Side
F1152	1400 - 2200	1,2,3,4,9,10,21 ¹ ,24 ¹ ,33,34,35,36,37,39	50 - 350	8.5	Low Side
F1162	2300 - 2700	7,38,40,41	50 - 500	8.8	Both

¹ - with High side injection

ORDERING INFORMATION

ABSOLUTE MAXIMUM RATINGS

VCC to GND	-0.3V to +5.5V
STBY	-0.3V to (VCC_ + 0.3V)
IF_A+, IF_B+, IF_A-, IF_B-, LO1_ADJ, LO2_ADJ	-0.3V to (VCC_ + 0.3V)
LO_IN, LO_IN_ALT, RF_A, RF_B	-0.3V to +0.3V
IF_BiasA, IF_BiasB to GND	-0.3V to +0.3V
RF Input Power (RF_A, RF_B)	+20dBm
Continuous Power Dissipation	2.2W
θ_{JA} (Junction – Ambient)	+35°C/W
θ_{JC} (Junction – Case) The Case is defined as the exposed paddle	+2.5°C/W
Operating Temperature Range (Case Temperature)	$T_C = -40^\circ\text{C}$ to $+100^\circ\text{C}$
Maximum Junction Temperature	150°C
Storage Temperature Range	-65°C to +150°C
Lead Temperature (soldering, 10s) .	+260°C

Stresses above those listed above may cause permanent damage to the device. Functional operation of the device at these or any other conditions above those indicated in the operational section of this specification is not implied. Exposure to absolute maximum rating conditions for extended periods may affect device reliability.

IDTF1100 SPECIFICATION (698 – 915 MHz MIXER W/HIGH SIDE INJECTION)

Specifications apply at $V_{CC} = +5.0V$, $F_{RF} = 850 \text{ MHz}$, $F_{IF} = 350\text{MHz}$, Hi-Side Inj., $P_{LO} = 0 \text{ dBm}$, $T_{CASE} = +25^{\circ}\text{C}$, $STBY = GND$, Trace and Transformer Losses de-embedded unless otherwise noted.

Parameter	Comment	Symbol	min	typ	max	units
Logic Input High	For Standby Pin	V_{IH}	2			V
Logic Input Low	For Standby Pin	V_{IL}			0.8	V
Logic Current	For Standby Pin	I_{IH}, I_{IL}	-5		+5	μA
Supply Voltage(s)	All V_{CC} pins	V_{CC}		4.75 to 5.25		V
Operating Temperature	Case Temperature	T_{CASE}		-40 to +100		degC
Supply Current	Total V_{CC} Both Channels	I_{STD}		350	395	mA
Supply Current	Standby Mode <ul style="list-style-type: none"> ▪ $STBY = V_{IH}$ ▪ Total Both Channels 	I_{STBY}		28	35	mA
RF Freq Range	Operating Range	F_{RF}		698 to 915		MHz
IF Freq Range	Operating Range	F_{IF}		150 to 450		MHz
LO Freq Range	Operating Range	F_{LO}		848 to 1365		MHz
LO Power	Operating Range	P_{LO}		-6 to +6		dBm
RF Input Impedance	Single Ended <i>Return Loss > 15 dB</i>	Z_{RF}		50		Ω
IF Output Impedance	Differential <i>Return Loss > 15 dB</i>	Z_{IF}		200		Ω
LO port Impedance	Single Ended <i>Return Loss > 15 dB</i>	Z_{LO}		50		Ω
Gain (low freq)	Conversion Gain <ul style="list-style-type: none"> • $F_{RF} = 698 \text{ MHz}$ • $F_{IF} = 450 \text{ MHz}$ • EVB trace and transformer loss = 0.9 dB 	G_1	7.8	8.9	10	dB
Gain (high freq)	Conversion Gain <ul style="list-style-type: none"> • $F_{RF} = 915 \text{ MHz}$ • $F_{IF} = 350 \text{ MHz}$ • EVB trace and transformer loss = 0.8 dB 	G_2	8.0	9.0	10	dB

IDTF1100 SPECIFICATION (CONTINUED)

Parameter	Comment	Symbol	min	typ	max	units
Noise Figure	<ul style="list-style-type: none"> $F_{RF} = 850$ MHz $F_{IF} = 350$ MHz 	NF_{STD}		10		dB
NF w/Blocker	<ul style="list-style-type: none"> 50 MHz offset blocker $P_{IN} = +10$ dBm $F_{IF} = 350$ MHz $F_{RF} = 900$ MHz 	NF_{BLK}		20.3		dB
Output IP3 – Narrowband	<ul style="list-style-type: none"> $P_{IN} = -10$ dBm per tone 800 KHz Tone Separation $F_{IF} = 350$ MHz $F_{RF} = 850$ MHz 	$IP3_{O1}$	38	41		dBm
Output IP3 – Wideband	<ul style="list-style-type: none"> $P_{IN} = -10$ dBm per tone 15 MHz Tone Separation $F_{IF} = 350$ MHz 	$IP3_{O2}$		41		dBm
2RF X 2LO rejection	<ul style="list-style-type: none"> $P_{RF} = -10$ dBm $F_{IF} = 350$ MHz $F_{LO} = 1200$ MHz $F_{SPUR} = F_{LO} - \frac{1}{2} F_{IF}$ 	2x2		-80		dBc
3RF X 3LO rejection	<ul style="list-style-type: none"> $P_{RF} = -10$ dBm $F_{IF} = 350$ MHz $F_{LO} = 1200$ MHz $F_{SPUR} = F_{LO} - \frac{1}{3} F_{IF}$ 	3x3		-82		dBc
1 dB Compression	<ul style="list-style-type: none"> Input referred $F_{IF} = 350$ MHz 	$P1dB_I$	12.4	13.1		dBm
Channel Isolation	IF_B Pout vs. IF_A w/ RF_A input	ISO_C		60		dB
LO to IF leakage		ISO_{LI}		-19	-13	dBm
RF to IF leakage	$P_{in} = -10$ dBm	ISO_{RI}		-39	-33	dBm
LO to RF leakage		ISO_{LR}		-40		dBm

 1 – Items in min/max columns in ***bold italics*** are Guaranteed by Test

2 – All other Items in min/max columns are Guaranteed by Design Centering

TYPICAL OPERATING CONDITIONS
Unless Otherwise Noted:

- Dotted Lines: 450 MHz IF / Solid Lines: 350 MHz IF
- High Side Injection
- 800 KHz Channel Spacing
- Average of ChA, ChB
- $P_{in} = -10$ dBm
- Trace & Transformer Losses de-embedded

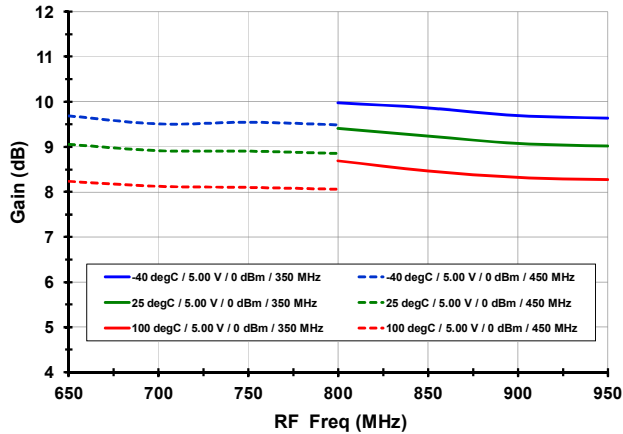
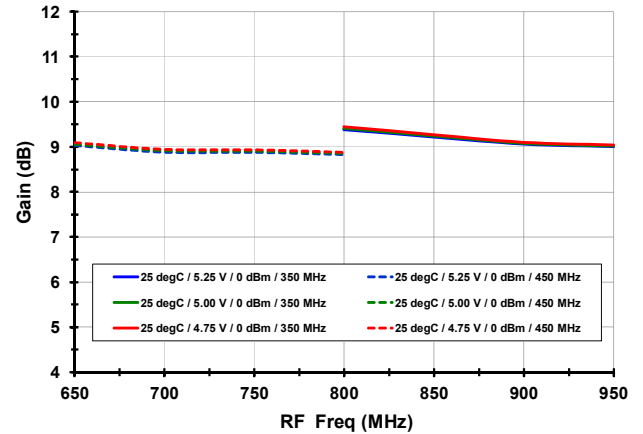
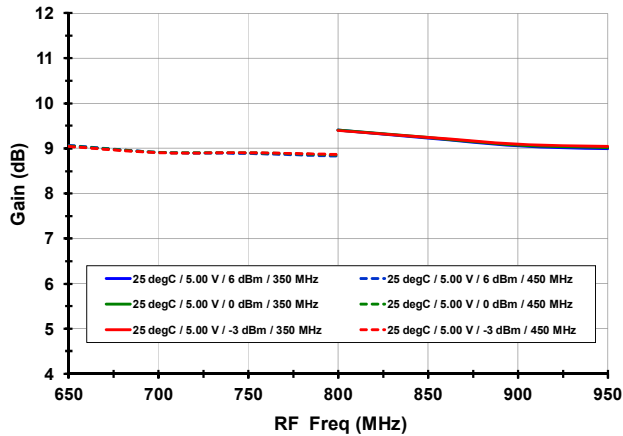
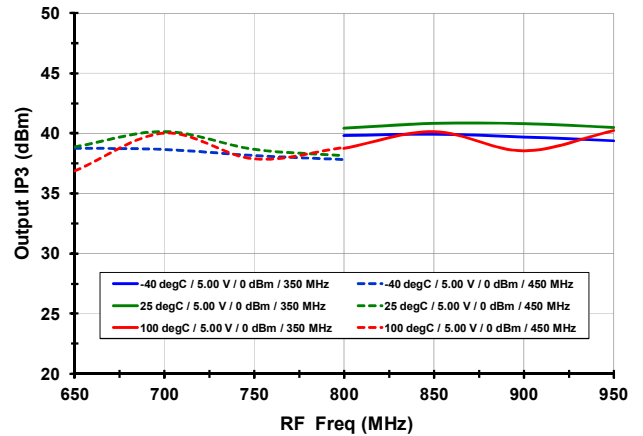
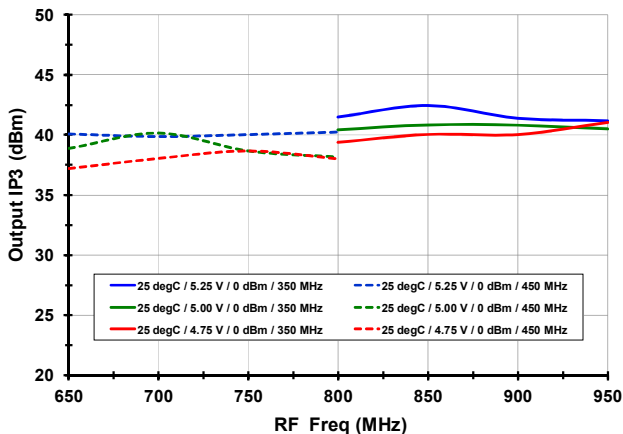
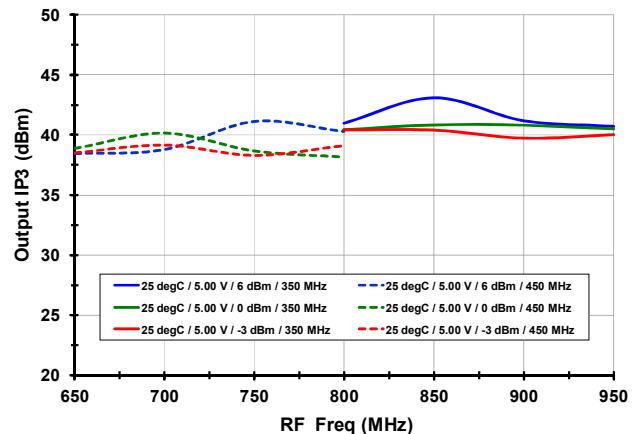
TYPICAL OPERATING CONDITIONS (-1-)
Gain vs. T_{CASE}

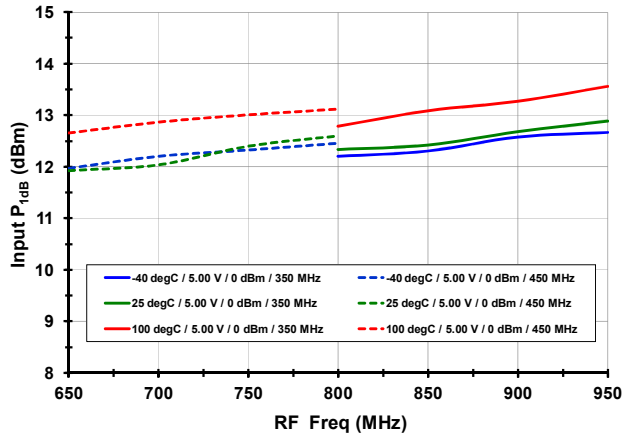
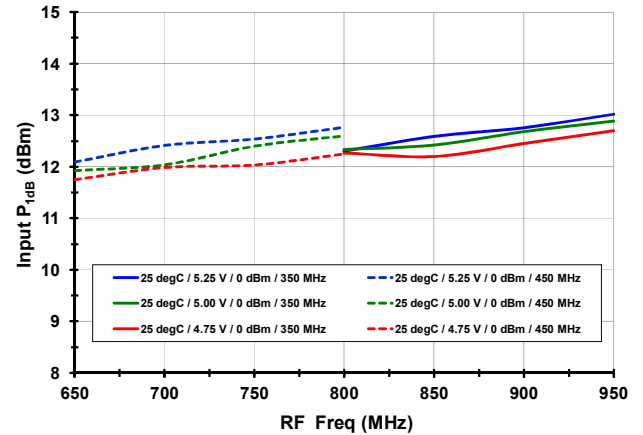
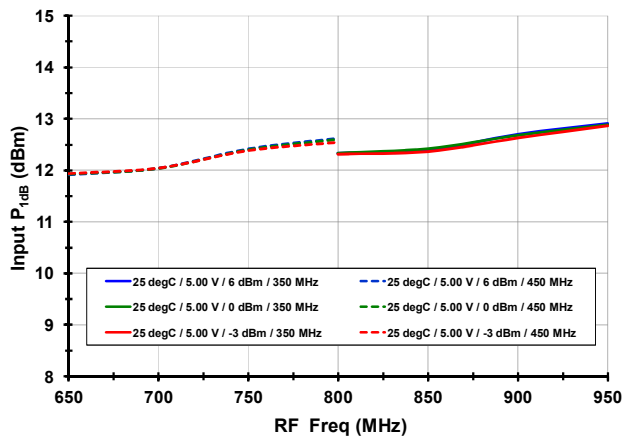
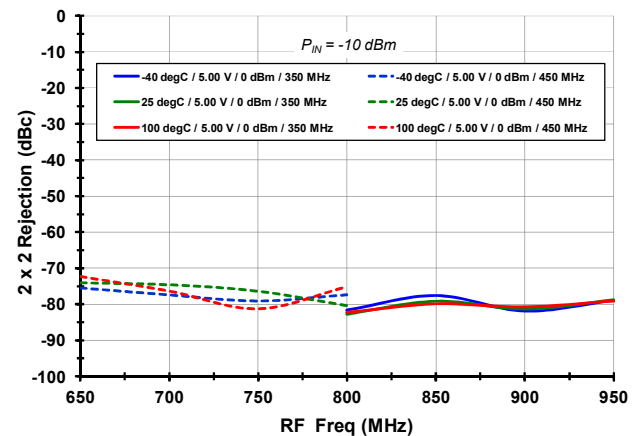
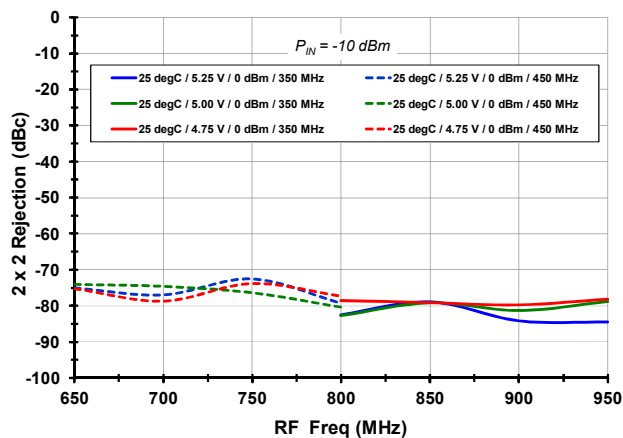
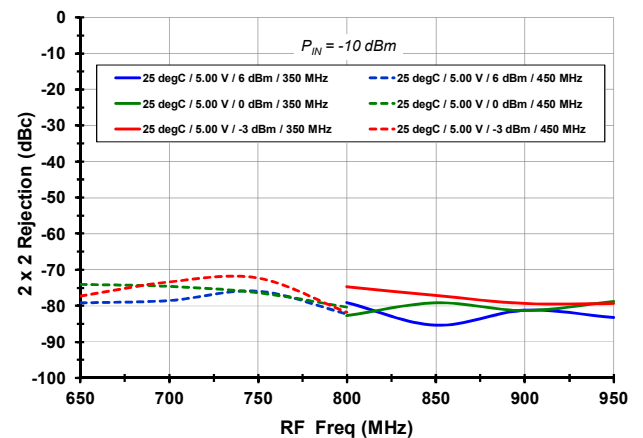
Gain vs. V_{CC}

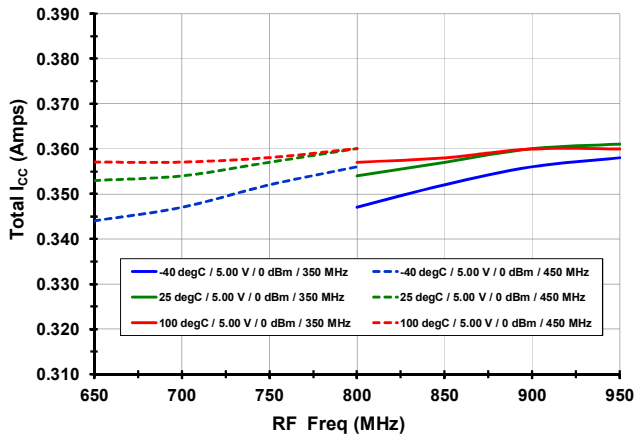
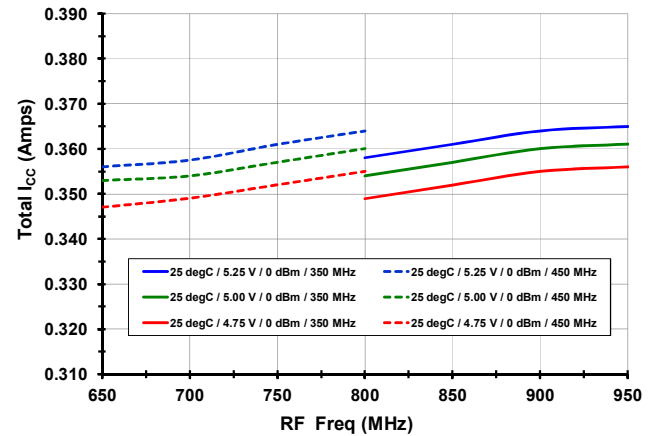
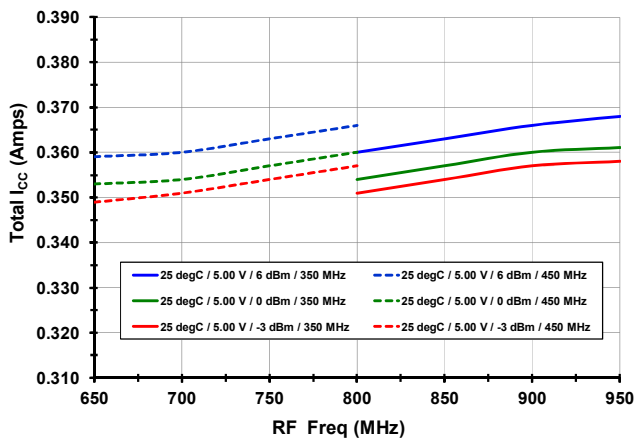
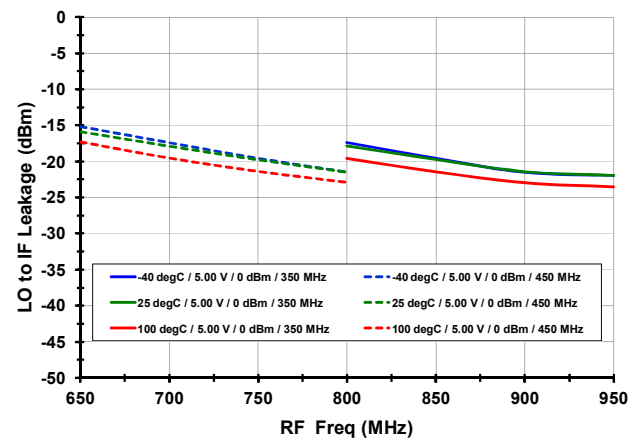
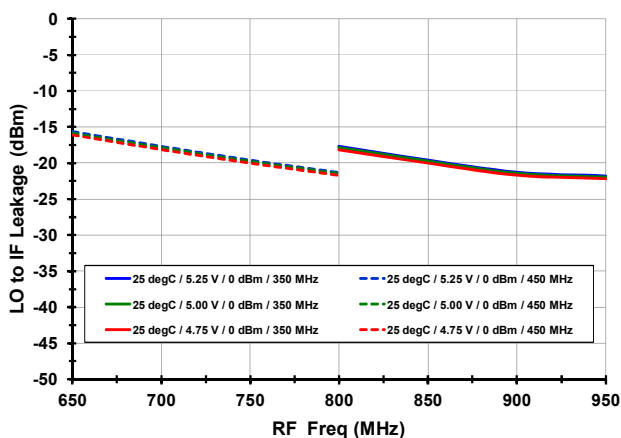
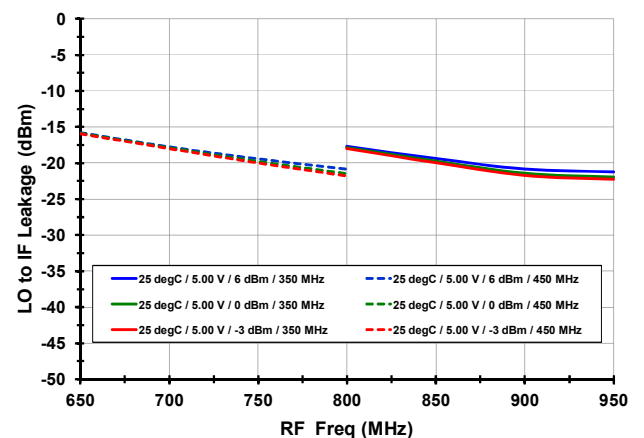
Gain vs. LO Level

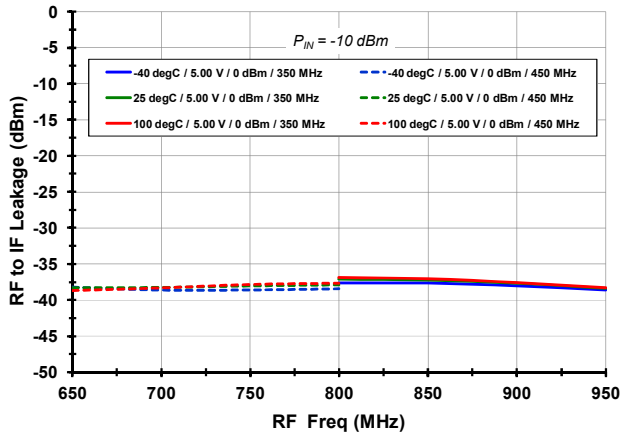
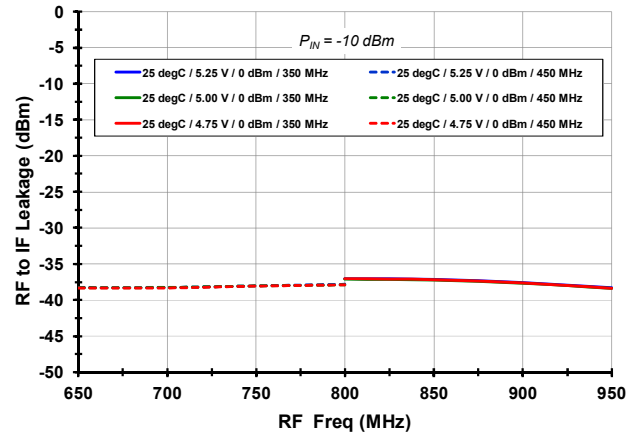
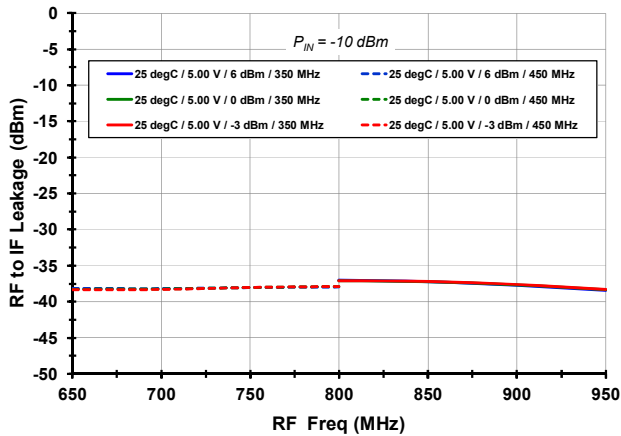
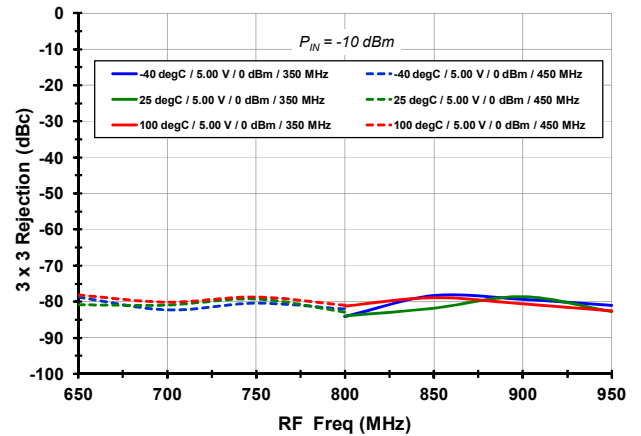
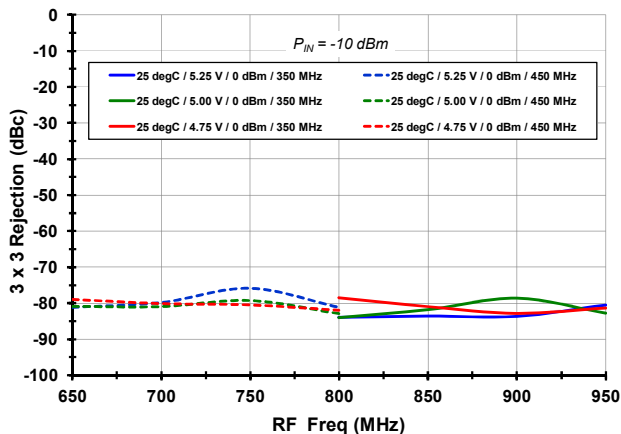
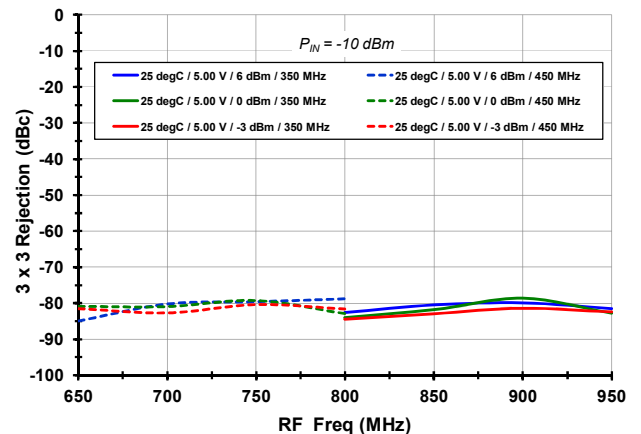
Output IP3 vs. T_{CASE}

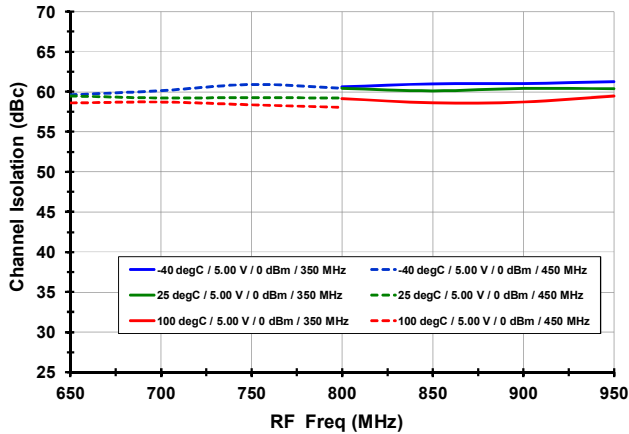
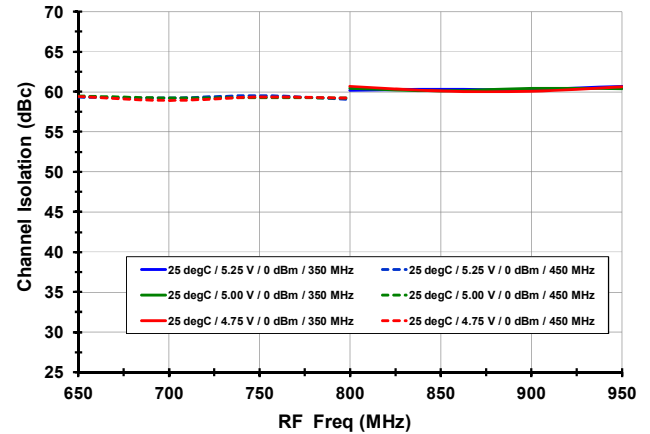
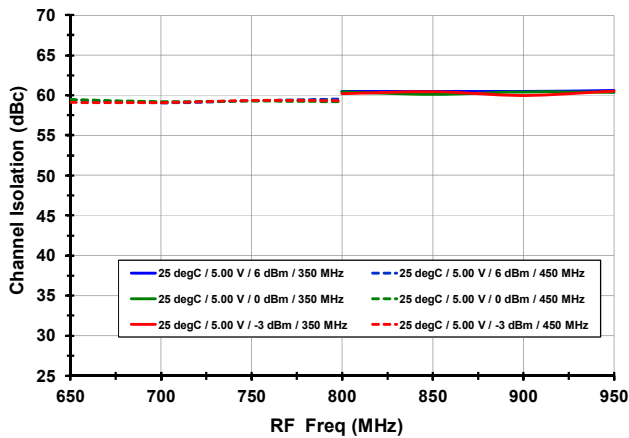
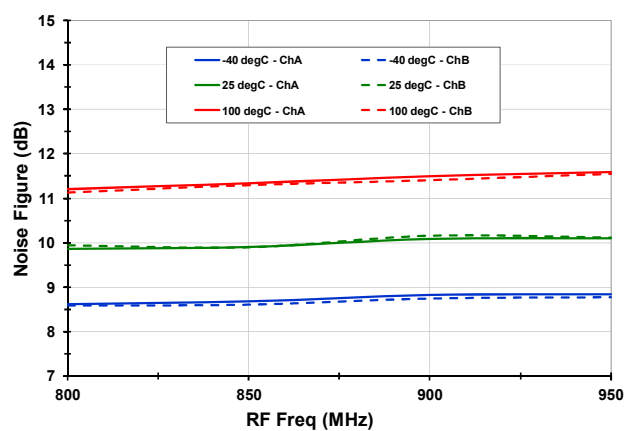
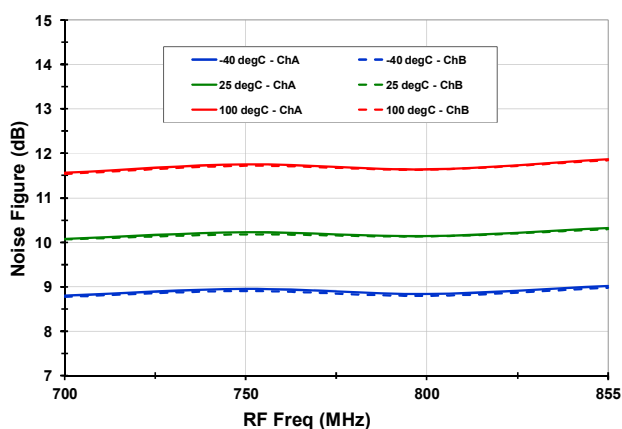
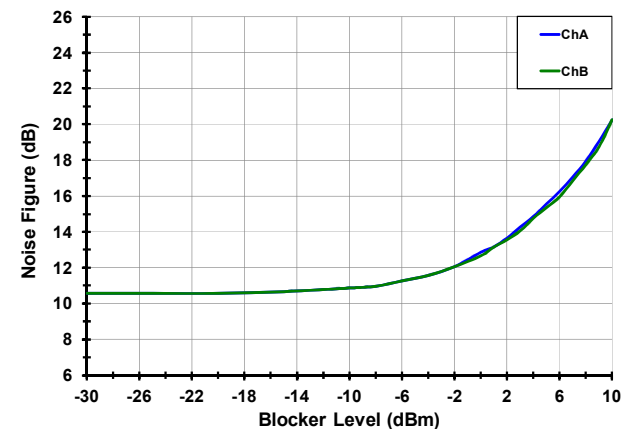
Output IP3 vs. V_{CC}

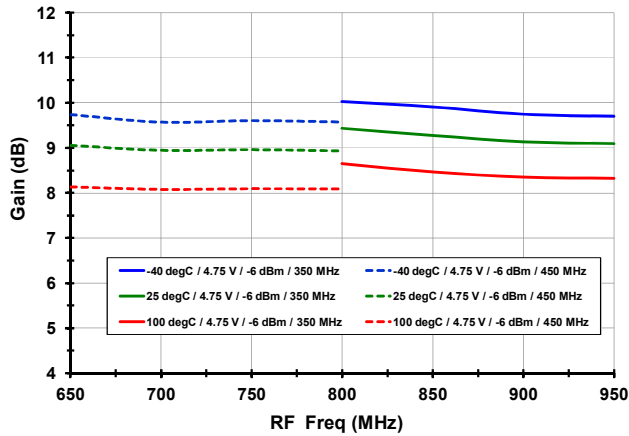
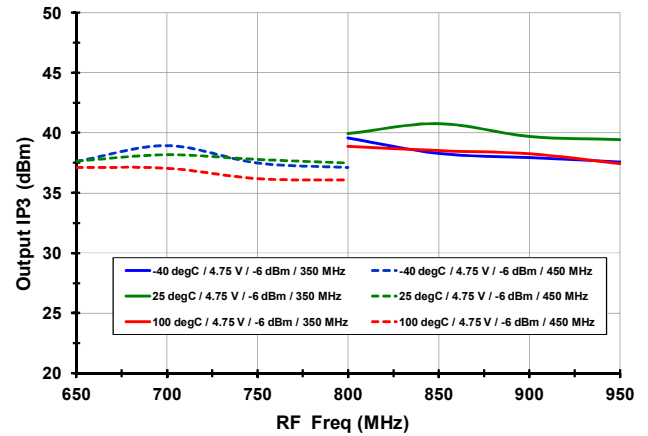
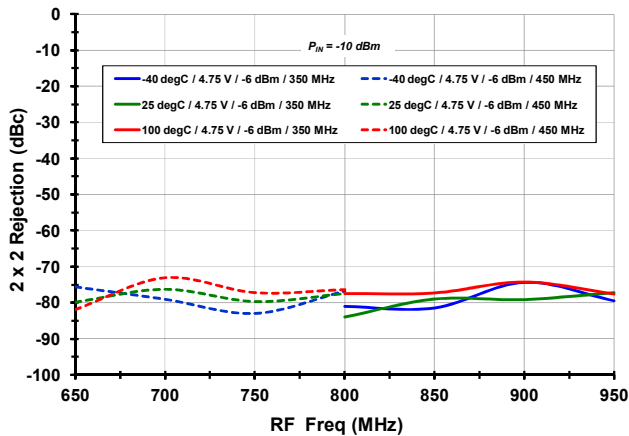
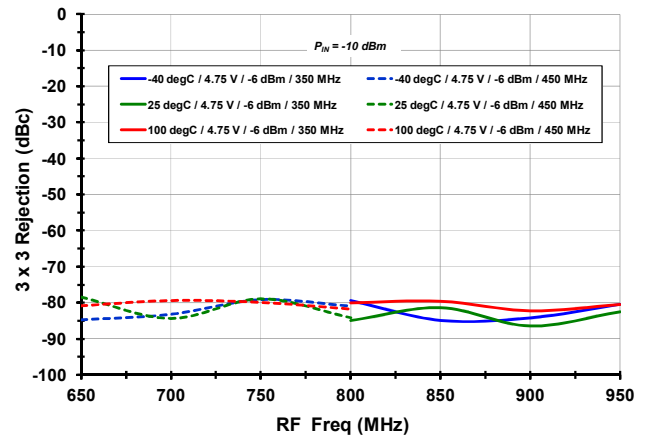
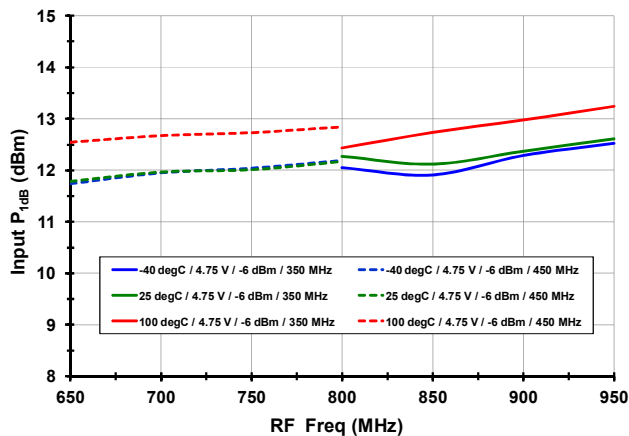
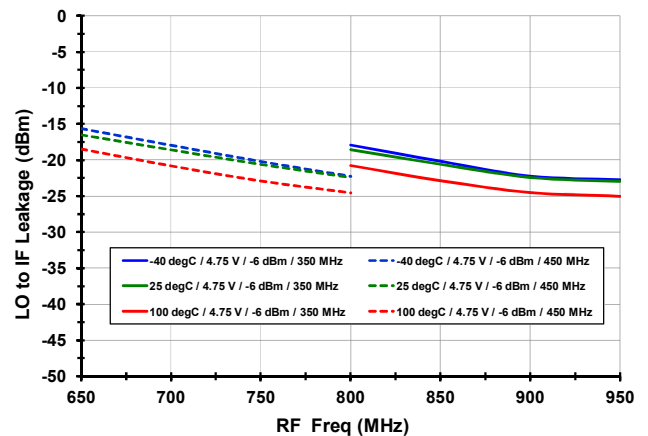
Output IP3 vs. LO Level

TYPICAL OPERATING CONDITIONS (-2-)
P1dB vs. T_{CASE}

P1dB vs. V_{CC}

P1dB vs. LO Level

2RF x 2LO rejection vs. T_{CASE}

2RF x 2LO Rejection vs. V_{CC}

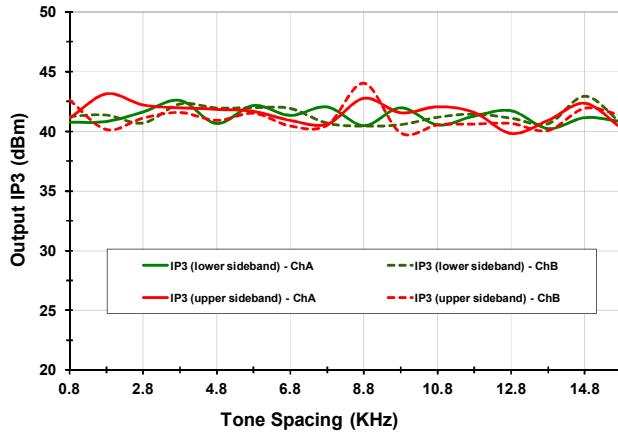
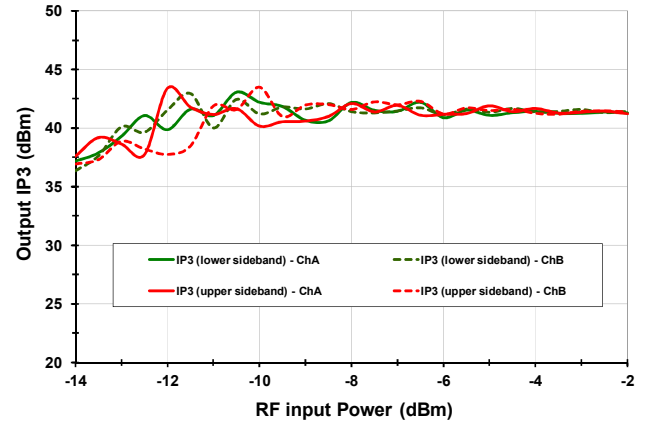
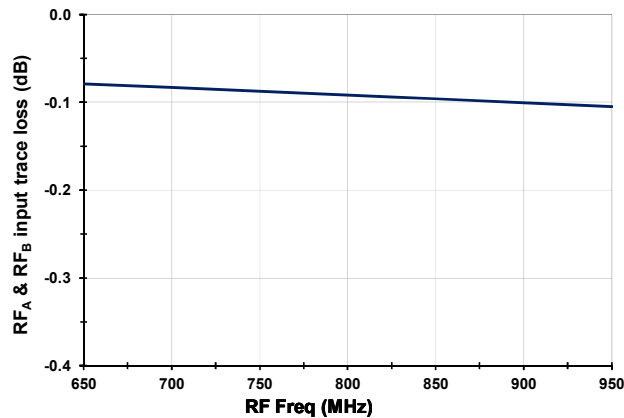
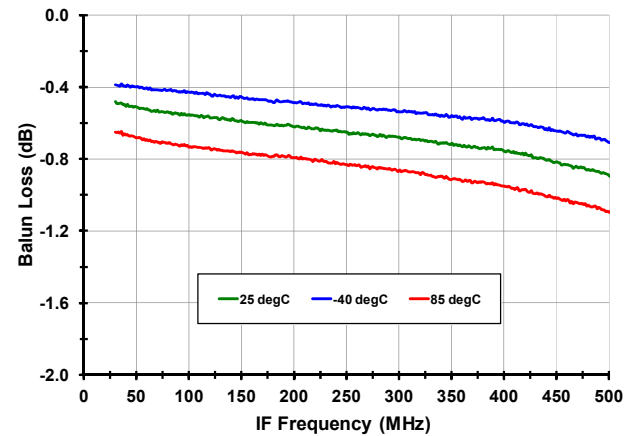
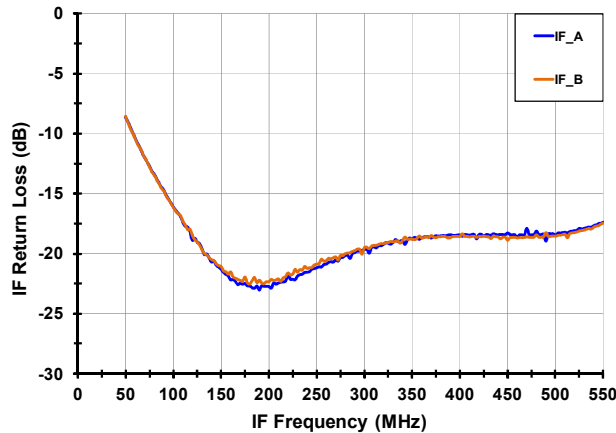
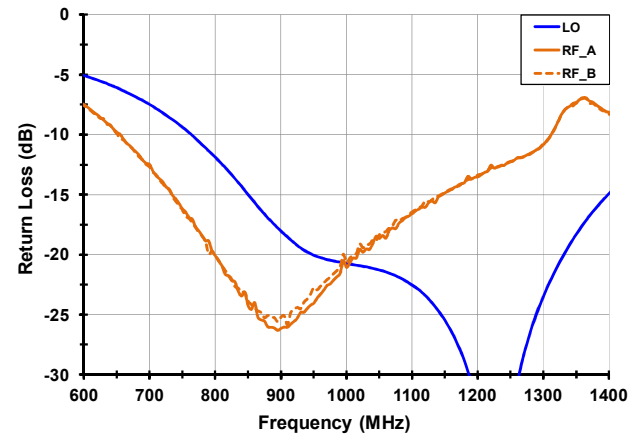
2RF x 2LO Rejection vs. LO Level

TYPICAL OPERATING CONDITIONS (-3-)
I_{CC} vs. T_{CASE}

I_{CC} vs. V_{CC}

I_{CC} vs. LO Level

LO-IF Leakage vs. T_{CASE}

LO-IF Leakage vs. V_{CC}

LO-IF Leakage vs. LO Level

TYPICAL OPERATING CONDITIONS (-4-)
RF-IF Leakage vs. T_{CASE}

RF-IF Leakage vs. V_{CC}

RF-IF Leakage vs. LO Level

3RF X 3LO Rejection vs. T_{CASE}

3RF X 3LO Rejection vs. V_{CC}

3RF X 3LO Rejection vs. LO Level

TYPICAL OPERATING CONDITIONS (-5-)
Channel Isolation vs. T_{CASE}

Channel Isolation vs. V_{CC}

Channel Isolation vs. LO Level

Noise Figure vs. T_{CASE} (350 MHz IF, RF trace de-embedded)

Noise Figure vs. T_{CASE} (450 MHz IF, RF trace de-embedded)

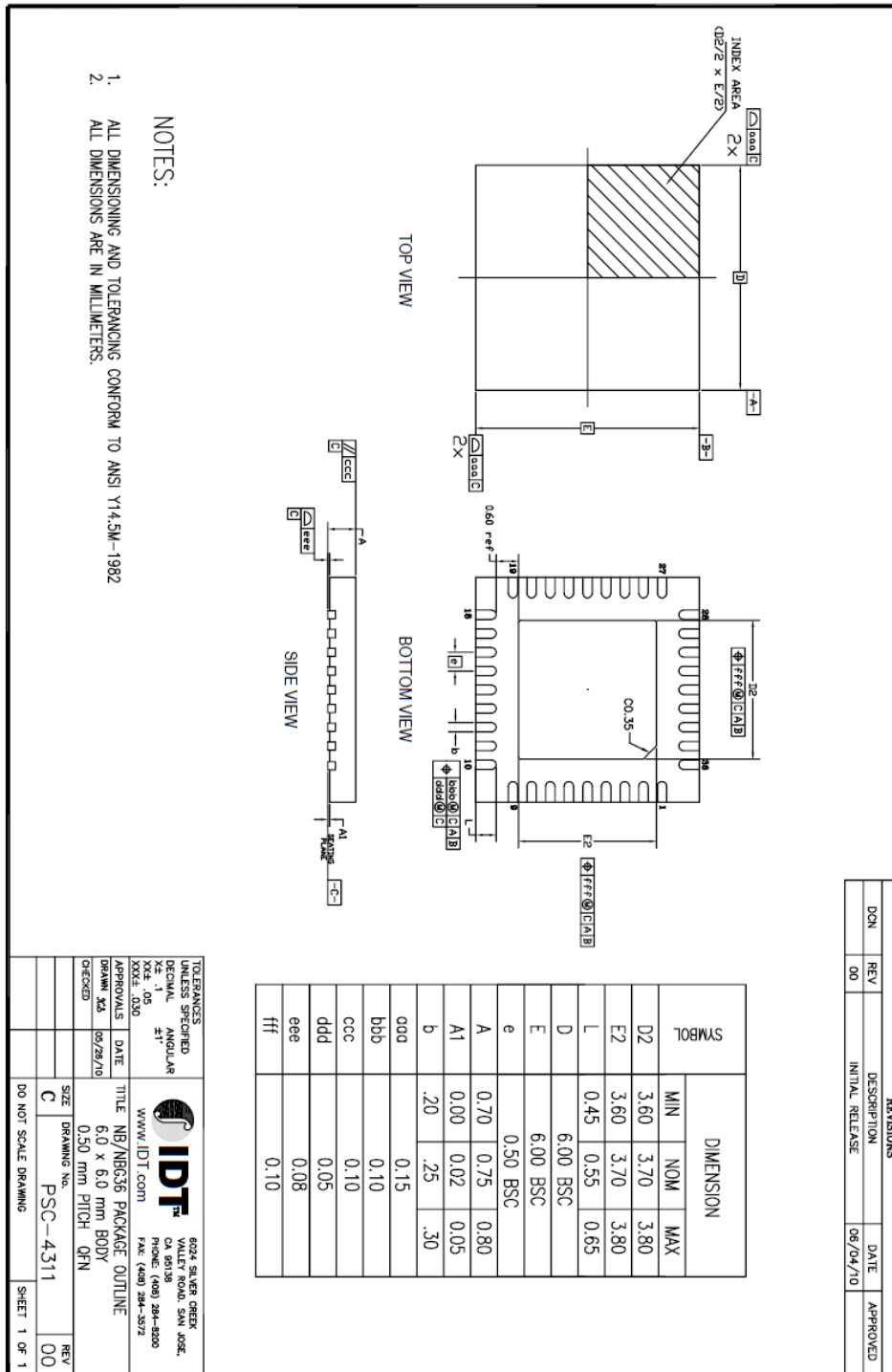
NF vs. Blocker (RF = 900 MHz, IF = 350 MHz, T_A = 25C)

RF to IF Dual Downconverting Mixer
698 - 915 MHz F1100NBGI
TYPICAL OPERATING CONDITIONS [*Extreme Conditions: low Supply, low LO level -6 dBm*] **(-6-)**
Gain

Output IP3

2x2 Rejection

3x3 Rejection

Input P1dB

LO to IF Leakage

RF to IF Dual Downconverting Mixer
698 - 915 MHz F1100NBGI
TYPICAL OPERATING CONDITIONS [General] (-7-)
IP_{3O} vs. Δf ($T_A = 25C$, Freq = 850 MHz, IF = 350 MHz)

IP_{3O} vs. P_{IN} ($T_A = 25C$, Freq = 850 MHz, IF = 350 MHz)

EVkit Input RF Trace Loss ($T_A = 25C$)

TC4-6T Transformer Loss

EVkit IF Port Match ($T_A = 25C$)

EVkit RF & LO Port Match ($T_A = 25C$)



PACKAGE DRAWING (6X6 QFN)



PINOUTS

Black Text denotes recommended external connection

Red Text denotes internal Function or Connection

- DB GND = Downbonded to Paddle
- Internal NC = Pin not connected

Please Note!

- Only connect to one LO feed
- Choose Either Pin 19 or Pin 27
- Do not connect the unused LO pin to ensure good LO return loss

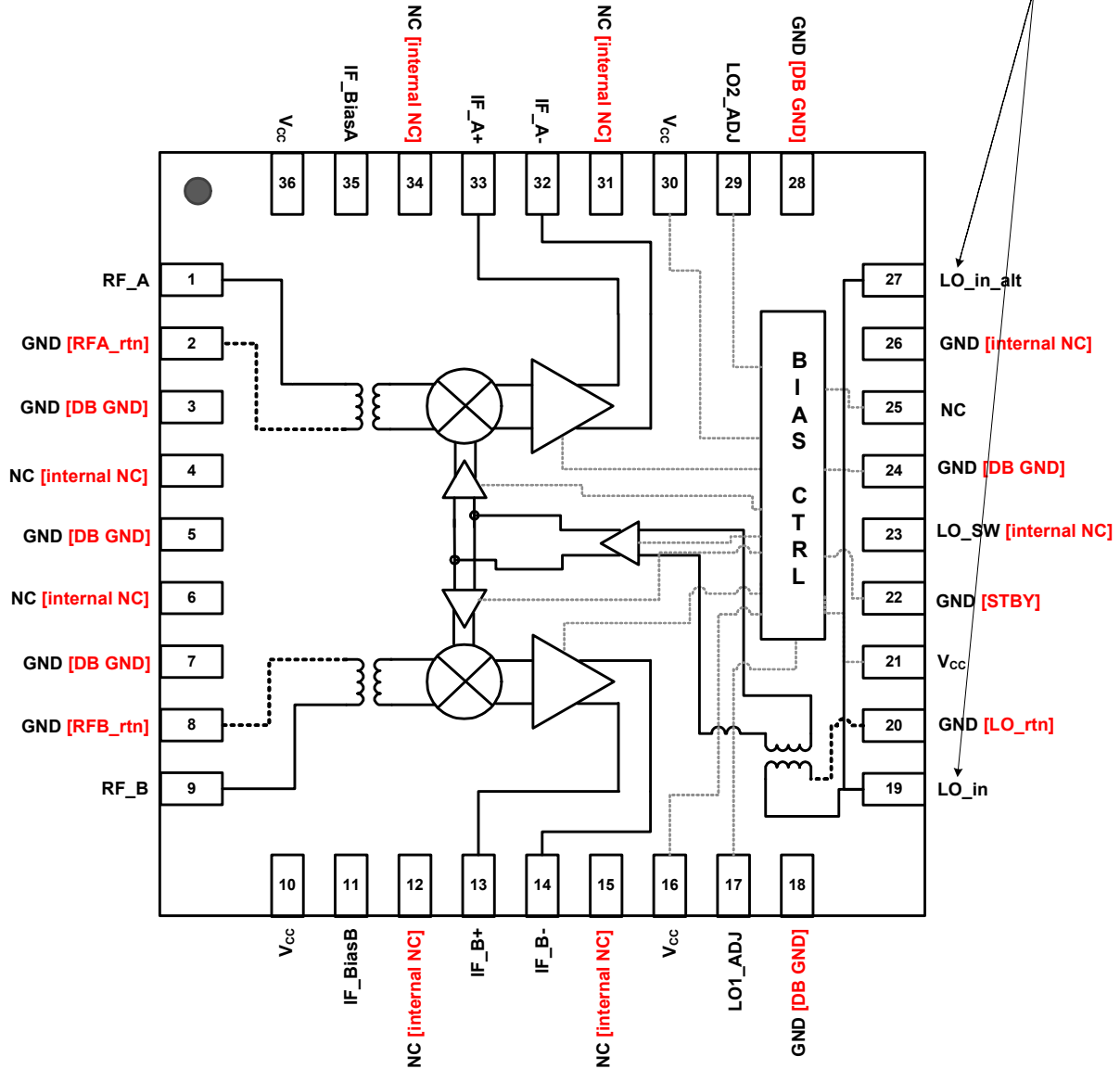

PIN DESCRIPTIONS

Pin	Name	Function
1	RF_A	Main Channel RF Input. Internally matched to 50Ω. DO NOT apply DC to these pins
2, 8, 20	RF_Artn, RF_Brtn, LO_rtn	Transformer Ground Returns. Ground these pins.
3, 5, 7, 18, 24, 28	GND	Ground these pins.
4, 6, 12, 15, 31, 23, 26, 34	N.C.	No Connection. Not internally connected. OK to connect to Vcc. OK to connect to GND
10, 16, 21, 30, 36	VCC	Power Supply. Bypass to GND with capacitors shown in the Typical Application Circuit as close as possible to pin.
9	RF_B	Diversity Channel RF Input. Internally matched to 50Ω
11	IF_BiasB	Connect the specified resistor from this pin to ground to set the bias for the Diversity IF amplifier. This is NOT a current set resistor
13, 14	IFB+, IFB-	Diversity Mixer Differential IF Output. Connect pullup inductors from each of these pins to VCC (see the Typical Application Circuit).
17	LO1_ADJ	Connect the specified resistor for either Standard or LC mode from this pin to ground to set the LO common buffer Icc
19, 27	LO_in LO_in_alt	Local Oscillator Input. Connect the LO to this port through the recommended coupling capacitor. Note that you can only drive one LO port at a time. Remove the series capacitor from the unused port.
25	NC	Make Certain this pin is not connected. It is normally reserved for selecting <i>low current</i> mode which the F1100 does not offer
22	STBY	STBY Mode. Pull this pin high for Standby mode (~28 mA). Pull low or Ground for normal Operation
29	LO2_ADJ	Connect the specified resistor for either Standard or LC mode from this pin to ground to set the LO drive buffers Icc
32, 33	IFA-, IFA+	Main Mixer Differential IF Output. Connect pullup inductors from each of these pins to VCC (see the Typical Application Circuit).
35	IF_BiasA	Connect the specified resistor from this pin to ground to set the bias for the Main IF amplifier. This is NOT a current set resistor
	— EP	Exposed Pad. Internally connected to GND. Solder this exposed pad to a PCB pad that uses multiple ground vias to provide heat transfer out of the device into the PCB ground planes. These multiple via grounds are also required to achieve the noted RF performance.

EVKIT SCHEMATIC

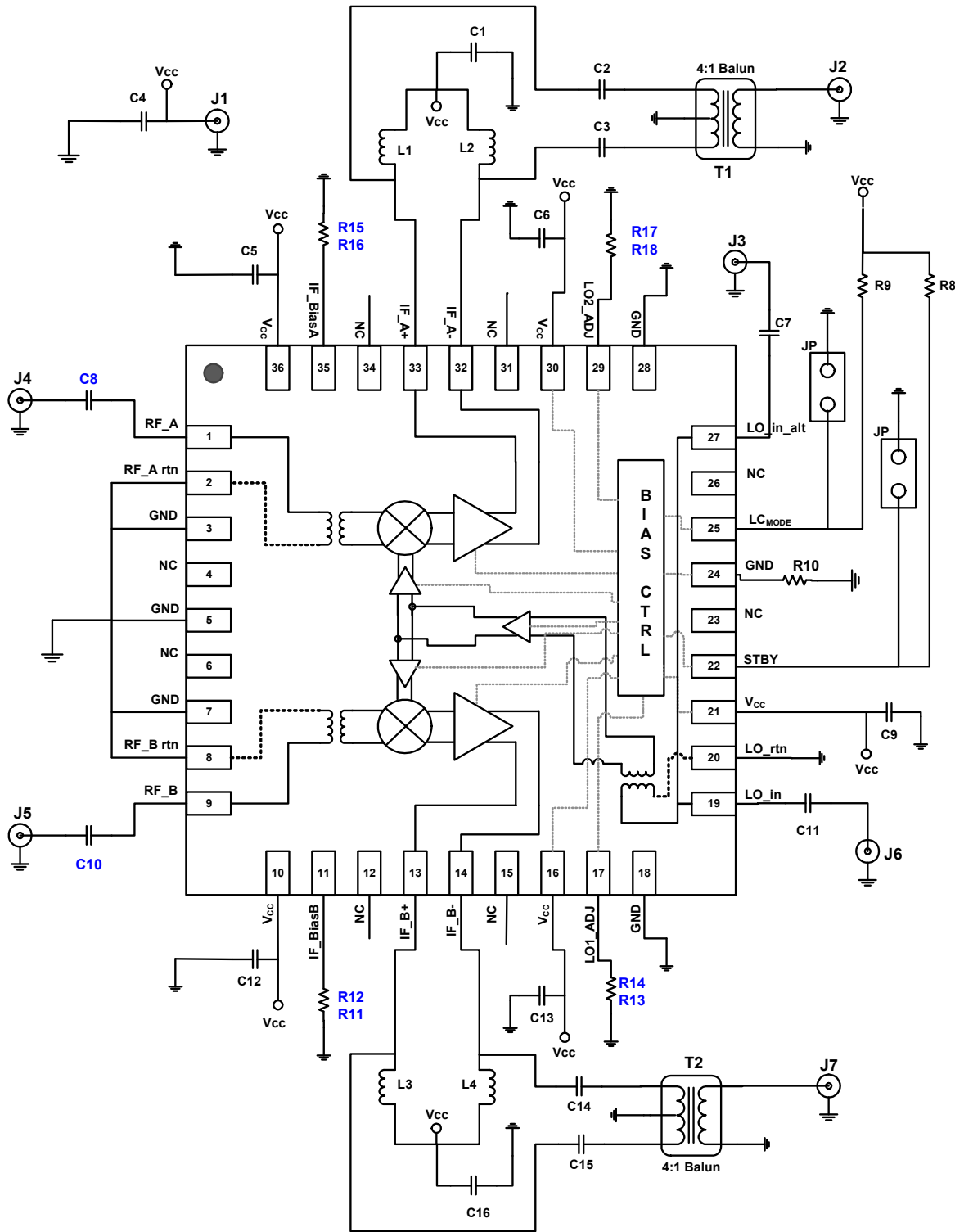

EVKIT PICTURE/LAYOUT/OPERATION

