

## Description

The F1420 is a high gain / high linearity RF amplifier used in high-performance RF applications. The F1420 provides 17.4dB gain with +42dBm OIP3 and 4.5dB noise figure at 960MHz. This device uses a single 5V supply and 105mA of  $I_{CC}$ .

In typical base stations, RF amplifiers are used in the RX and TX traffic paths to boost signal levels. The F1420 amplifier offers very high reliability due to its construction using silicon die in a QFN package.

## Competitive Advantage

In typical base stations, RF amplifiers are used in the RX and TX traffic paths to boost signal levels. The F1420 amplifier offers very high reliability due to its construction using silicon die in a QFN package.

## Typical Applications

- Multi-mode, multi-carrier transmitters
- GSM850/900 base stations
- PCS1900 base stations
- DCS1800 base stations
- WiMAX and LTE base stations
- UMTS/WCDMA 3G base stations
- PHS/PAS base stations
- Public safety infrastructure

## Features

- Broadband 700MHz to 1.1GHz
- 17.4dB typical gain at 960MHz
- 4.5dB noise figure at 960MHz
- +42dBm OIP3 at 960MHz
- +23.2dBm output P1dB at 960MHz
- Single 5V supply voltage
- $I_{CC} = 105\text{mA}$
- $-40^{\circ}\text{C}$  to  $+105^{\circ}\text{C}$  operating temperature
- $50\Omega$  single-ended input / output impedances
- Standby mode for power savings
- 4mm x 4mm, 24-pin QFN package

## Block Diagram

Figure 1. Block Diagram

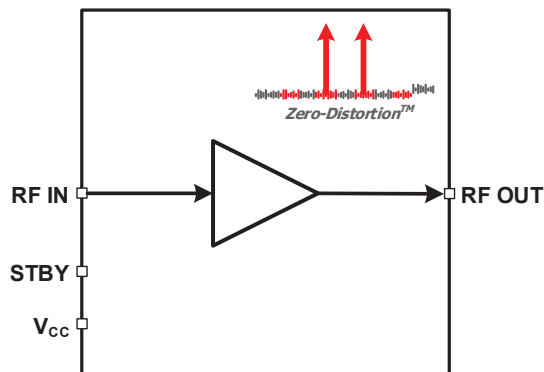

## Pin Assignments

Figure 2. Pin Assignments for 4mm x 4mm x 0.9mm QFN Package – Top View

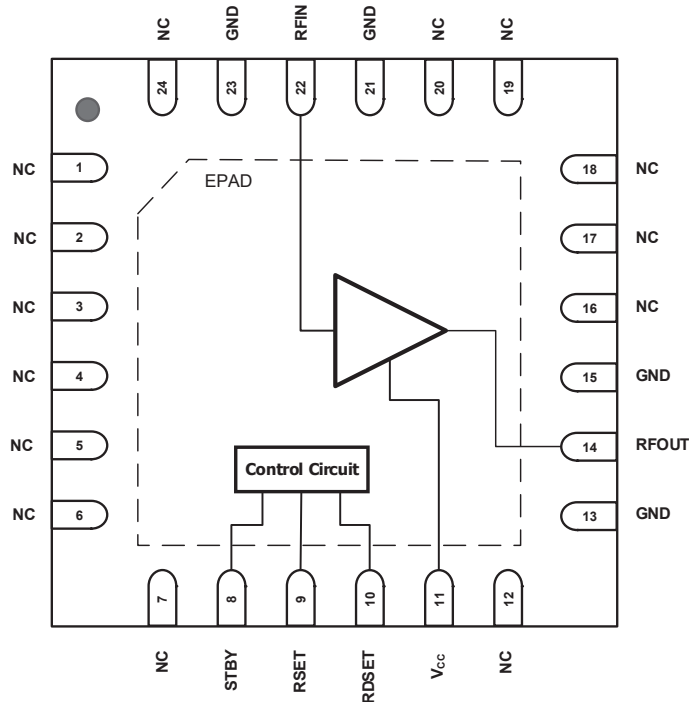

## Pin Descriptions

Table 1. Pin Descriptions

Number	Name	Description
1 - 7, 12, 16 - 19, 20, 24	NC	No internal connection. These pins can be left unconnected, have a voltage applied, or be connected to ground (recommended).
8	STBY	Standby (HIGH = device power OFF, LOW/Open = device power ON). Internally this pin has a pull-down resistor that is connected to GND.
9	RSET	Amplifier bias current setting resistor. Connect 2.26kΩ resistor to ground.
10	RDSET	Amplifier 2nd bias current setting resistor. Connect 5.76kΩ resistor to ground.
11	V <sub>CC</sub>	Power Supply for the Amplifier.
13, 15, 21, 23	GND	Internally grounded. These pins must be grounded as close to the device as possible.
14	RFOUT	RF output. Must use external DC block as close to the pin as possible.
22	RFIN	RF input internally matched to 50Ω. Must use external DC block. DC block should be placed as close to the pin for best RF performance.
	- EPAD	Exposed paddle. Internally connected to ground. Solder this exposed paddle to a printed circuit board (PCB) pad that uses multiple ground vias to provide heat transfer out of the device into the PCB ground planes. These multiple ground vias are also required to achieve the specified RF performance.

## Absolute Maximum Ratings

The absolute maximum ratings are stress ratings only. Stresses greater than those listed below can cause permanent damage to the device. Functional operation of the F1420 at absolute maximum ratings is not implied. Exposure to absolute maximum rating conditions may affect device reliability.

**Table 2. Absolute Maximum Ratings**

Parameter	Symbol	Minimum	Maximum	Units
Supply Voltage	$V_{CC}$	-0.3	+5.5	V
STBY	$V_{STBY}$	-0.3	$V_{CC} + 0.25$	V
RFIN Externally Applied DC Voltage	$I_{RFIN}$	-0.3	+0.3	V
RFOUT Externally Applied DC voltage	$V_{RFOUT}$	$V_{CC} - 0.15$	$V_{CC} + 0.15$	V
Maximum RF CW Input Power	$P_{MAX\_IN}$		+18	dBm
Continuous Power Dissipation	$P_{DISS}$		1.5	W
Junction Temperature	$T_{JMAX}$		+150	°C
Storage Temperature Range	$T_{STOR}$	-65	+150	°C
Lead Temperature (soldering, 10s)	$T_{LEAD}$		+260	°C
Electrostatic Discharge – HBM (JEDEC/ESDA JS-001-2012)	$V_{ESDHBM}$		2000 (Class 2)	V
Electrostatic Discharge – CDM (JEDEC 22-C101F)	$V_{ESDCDM}$		500 (Class C2)	V

## Recommended Operating Conditions

**Table 3. Recommended Operating Conditions**

Parameter	Symbol	Condition	Minimum	Typical	Maximum	Units
Supply Voltage	$V_{CC}$		4.75		5.25	V
Operating Temperature Range	$T_{EP}$	Exposed Paddle	-40		+105	°C
RF Frequency Range	$f_{RF}$	Operating Range	700		1100	MHz
Maximum Operating Input RF Power [a]	$P_{OUT\_MAX}$				+10	dBm
RF Source Impedance	$Z_{RFI}$	Single Ended		50		$\Omega$
RF Load Impedance	$Z_{RFO}$	Single Ended		50		$\Omega$

[a] Input / output load impedance < 2:1 VSWR any phase based in a 50 $\Omega$  system.

## Electrical Characteristics

See the F1420 Typical Application Circuit. Specifications apply when operated at  $V_{CC} = +5.0V$ ,  $f_{RF} = 960MHz$ ,  $T_{EP} = +25^{\circ}C$ ,  $Z_S = Z_L = 50\Omega$ , tone spacing = 5MHz,  $P_{OUT} = +4dBm/$ tone, evaluation board (EVKit) traces and connectors are de-embedded, unless otherwise stated.

**Table 4. Electrical Characteristics**

Parameter	Symbol	Condition	Minimum	Typical	Maximum	Units
Logic Input High Threshold	$V_{IH}$		<b>1.1</b> [a]		$V_{CC}$	V
Logic Input Low Threshold	$V_{IL}$				<b>0.8</b>	V
Logic Current	$I_{IL}, I_{IH}$	Standby Pin	<b>-10</b>		<b>10</b>	$\mu A$
Supply Current	$I_{CC}$	Standby = LOW or open		105	<b>120</b>	mA
	$I_{CC\_STBY}$	Standby = HIGH		0.6	<b>2</b>	mA
Gain	$G_{700}$	$f_{RF} = 700MHz$		17.2		dB
	$G_{960\text{ LB}}$	$f_{RF} = 960MHz$	<b>16.4</b>	17.4	<b>18.4</b>	
	$G_{1100\text{ LB}}$	$f_{RF} = 1100MHz$		17.5		
Input Return Loss	$RL_{IN}$			17		dB
Output Return Loss	$RL_{OUT}$			14		dB
Gain Flatness	$G_{FLAT}$			0.4		dB
Gain Ripple	$G_{RIPPLE}$	In any 20MHz range over RF Band		$\pm 0.04$		dB
Noise Figure	NF	$f_{RF} = 700MHz$		4.6		dB
		$f_{RF} = 960MHz$		4.5		
		$f_{RF} = 1100MHz$		4.5		
		$f_{RF} = 700MHz, T_{EP} = +105^{\circ}C$		5.8		
Output Third Order Intercept Point	OIP3	$f_{RF} = 750MHz$ to 960MHz $P_{OUT} = +4dBm/$ tone 5MHz tone delta	38	42		dBm
Output 1dB Compression	OP1dB		20	23.2		dBm
Power ON Switching Time	$t_{ON}$	50% STBY control to within 0.2dB of the on state final gain value		120		ns
Power OFF Switching Time	$t_{OFF}$	50% STBY control to 30 dB below on state gain value		80		ns

[a] Specifications in the minimum/maximum columns that are shown in **bold italics** are guaranteed by test. Specifications in these columns that are not shown in bold italics are guaranteed by design characterization.

## Thermal Characteristics

**Table 5. Package Thermal Characteristics**

Parameter	Symbol	Value	Units
Junction to Ambient Thermal Resistance	$\theta_{JA}$	45	°C/W
Junction to Case Thermal Resistance (Case is defined as the exposed paddle)	$\theta_{JC-BOT}$	36	°C/W
Moisture Sensitivity Rating (Per J-STD-020)		MSL 1	

## Typical Operating Conditions (TOC)

- $V_{cc} = 5.0V$
- $Z_L = Z_S = 50\Omega$  Single Ended
- $f_{RF} = 960MHz$
- $T_{EP} = 25^\circ C$  (All temperatures are referenced to the exposed paddle)
- STBY = LOW (0V)
- $P_{out} = +4dBm/Tone$
- 5MHz Tone Spacing
- Evaluation Kit traces and connector losses are de-embedded

## Typical Performance Characteristics

Figure 3. Gain vs Frequency

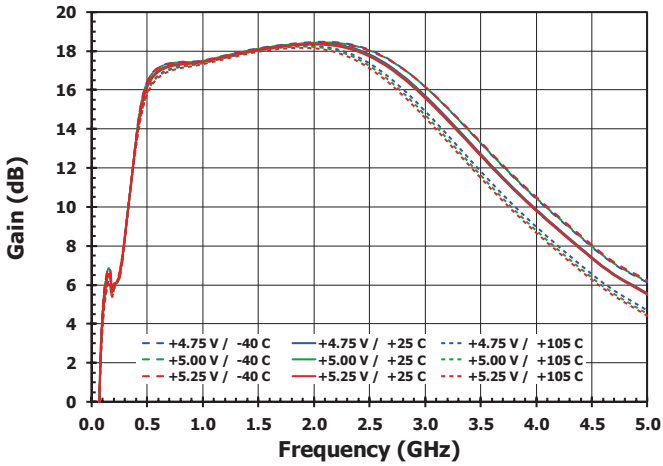

Figure 5. Input Return Loss vs Frequency

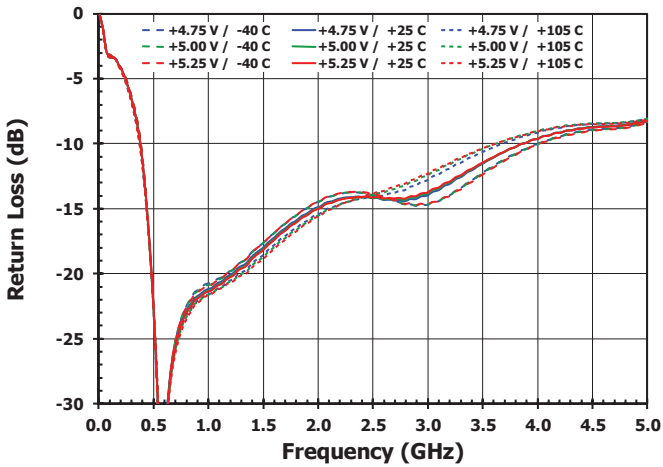

Figure 7. Gain vs Frequency

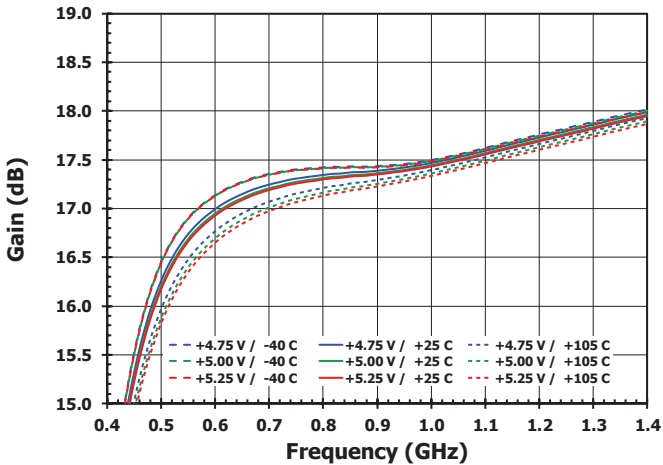

Figure 4. Reverse Isolation vs Frequency

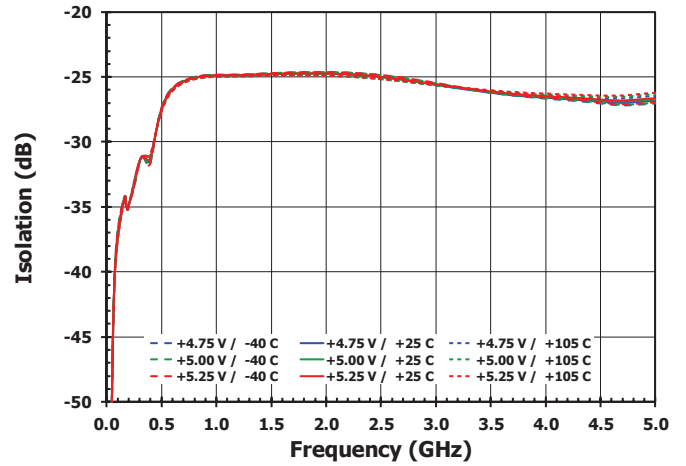

Figure 6. Output Return Loss vs Frequency

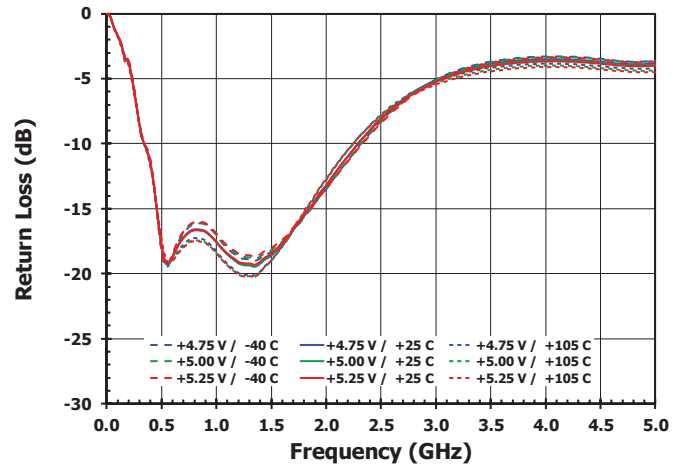
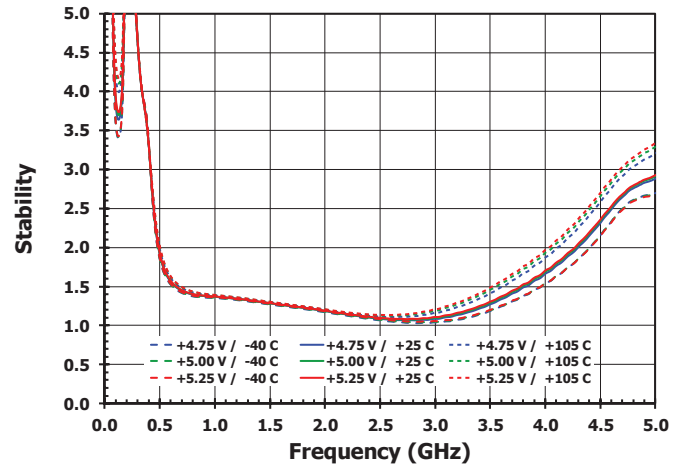

Figure 8. Stability vs Frequency



## Typical Performance Characteristics

Figure 9. Output IP3 versus Frequency

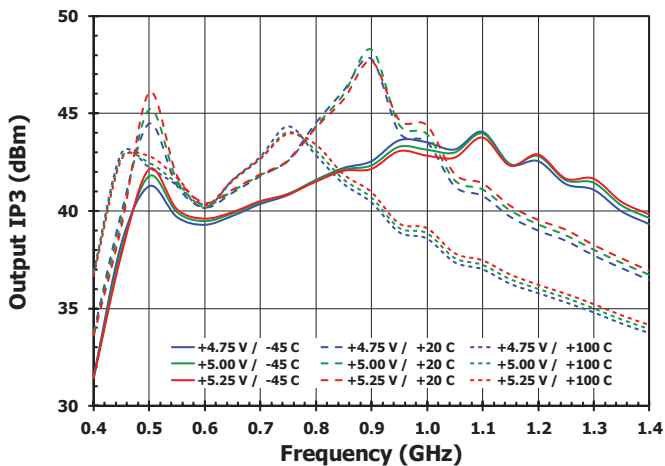

Figure 11. Second Harmonic versus Frequency

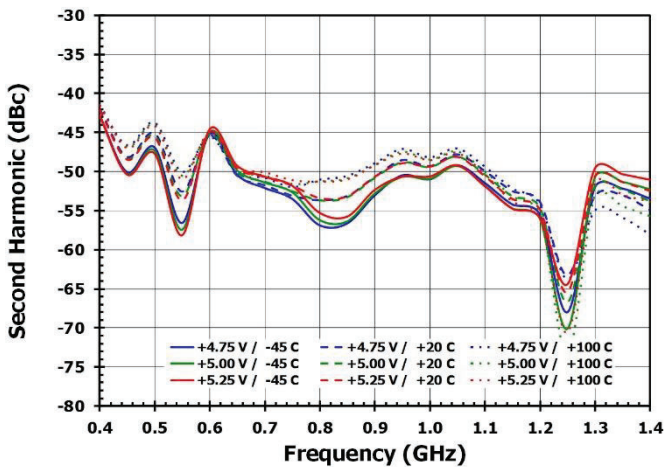

Figure 13. Noise Figure versus Frequency

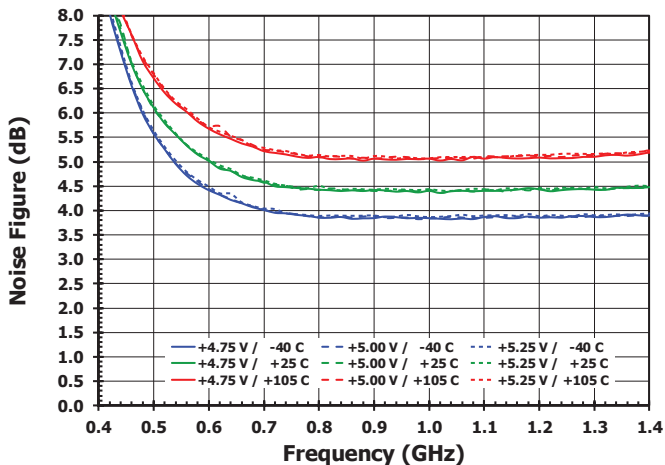

Figure 10. Output P1dB versus Frequency

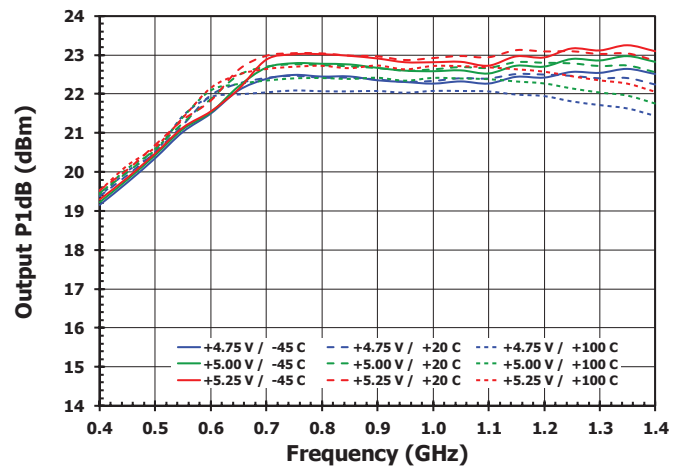

Figure 12. Third Harmonic versus Frequency

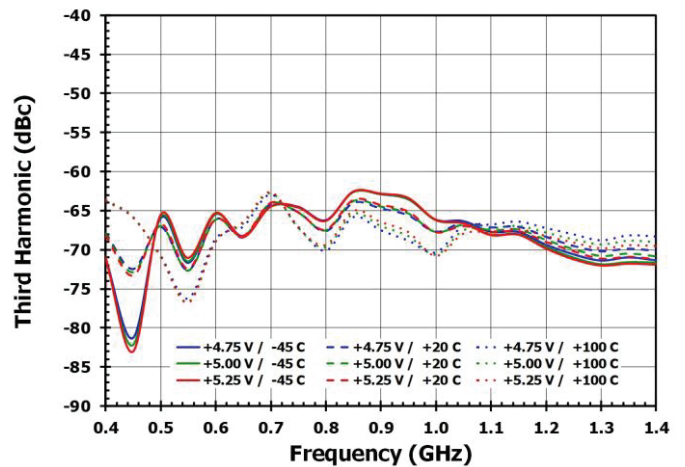
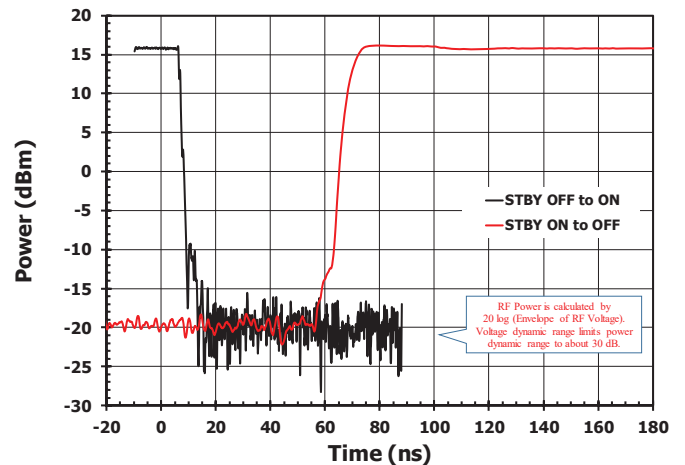

Figure 14. Standby Switching Speed





## Evaluation Kit Picture

Figure 15. Top View

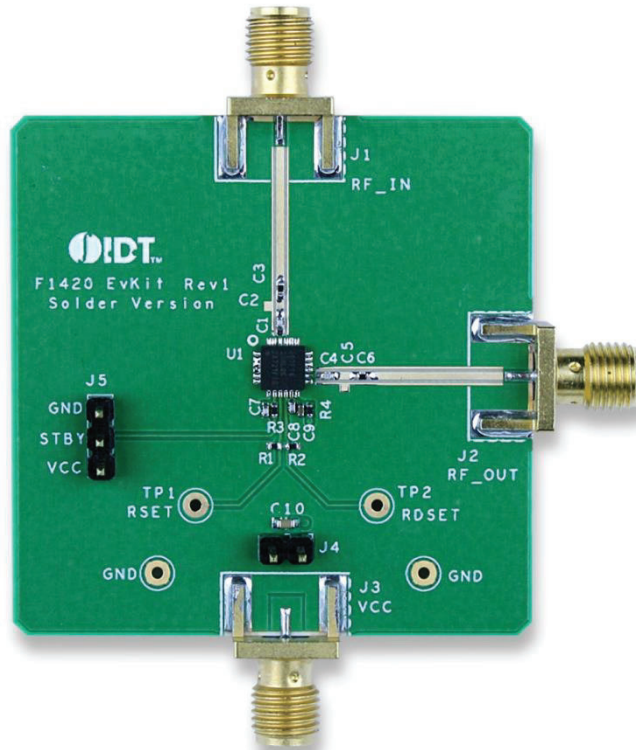
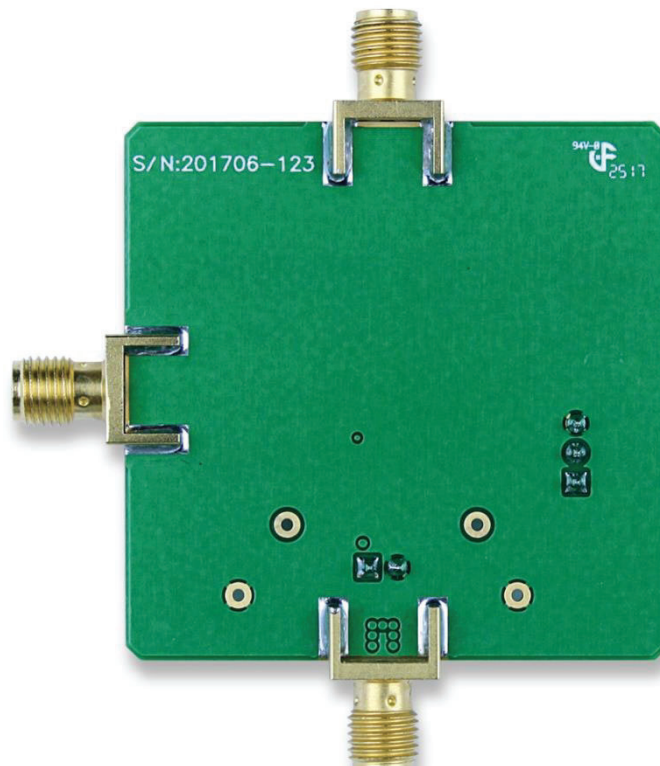
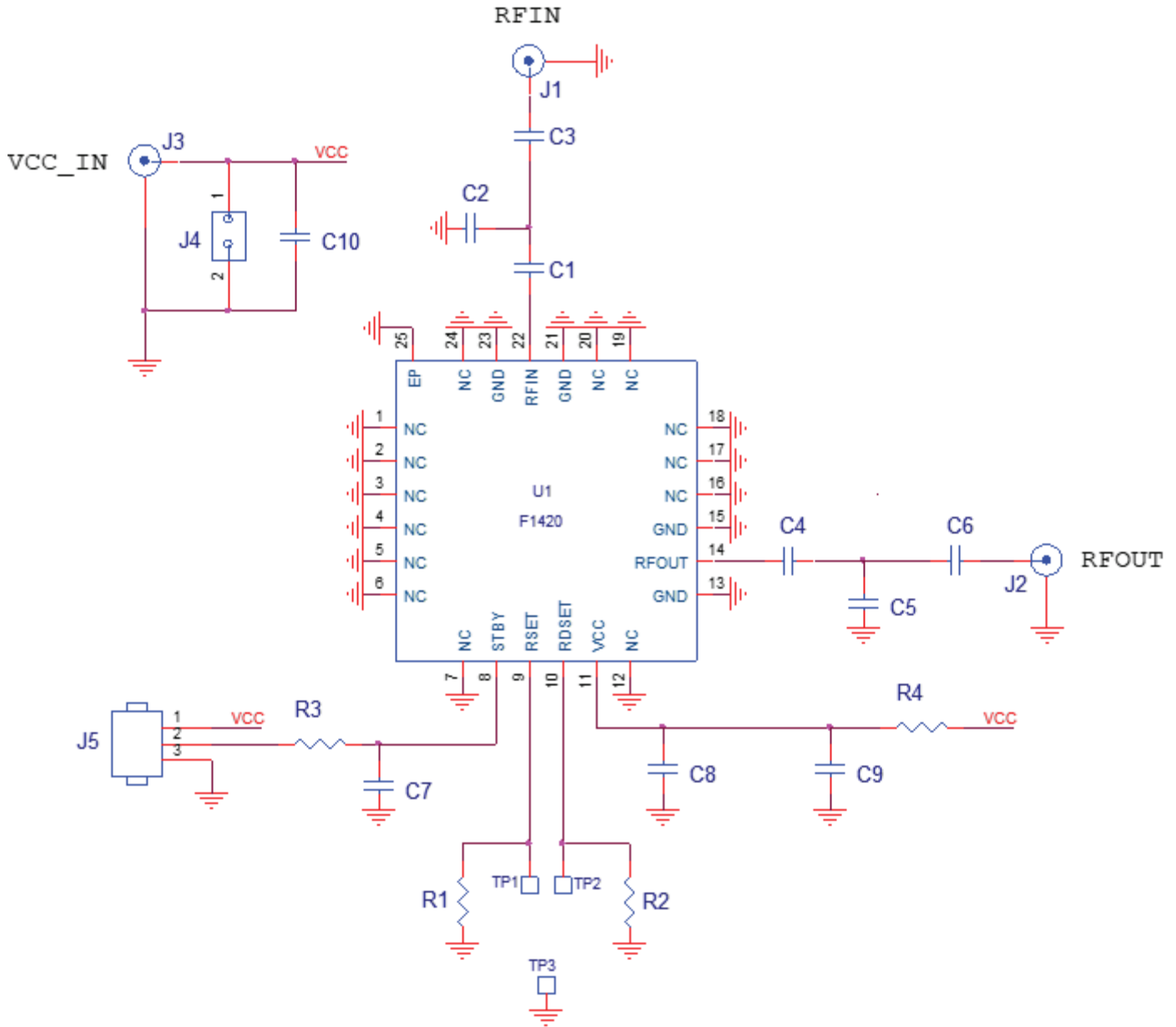

Figure 16. Bottom View



## Evaluation Kit / Applications Circuit

Figure 17. Electrical Schematic



**Table 6. Bill of Material (BOM)**

Part Reference	QTY	Description	Manufacturer Part #	Manufacturer
C1, C4	2	47pF $\pm$ 5%, 50V, C0G Ceramic Capacitor (0402)	GRM1555C1H470J	Murata
C7	1	2pF $\pm$ 0.1pF, 50V, C0G Ceramic Capacitor (0402)	GRM1555C1H2R0B	Murata
C8	1	1000pF $\pm$ 5%, 50V, C0G Ceramic Capacitor (0402)	GRM1555C1H102J	Murata
C9	1	0.1 $\mu$ F $\pm$ 10%, 16V, X7R Ceramic Capacitor (0402)	GRM155R71C104K	Murata
C10	1	10 $\mu$ F $\pm$ 20%, 16V, X6S Ceramic Capacitor (0603)	GRM188C81C106M	Murata
R1	1	2.26k $\Omega$ $\pm$ 1%, 1/10W, Resistor (0402)	ERJ-2RKF2261X	Panasonic
R2	1	5.76k $\Omega$ $\pm$ 1%, 1/10W, Resistor (0402)	ERJ-2RKF5761X	Panasonic
R3	1	1k $\Omega$ $\pm$ 1%, 1/10W, Resistor (0402)	ERJ-2RKF1001X	Panasonic
C3, C6, R4	3	0 $\Omega$ Resistors (0402)	ERJ-2GE0R00X	Panasonic
J4	1	CONN HEADER VERT SGL 2 X 1 POS GOLD	961102-6404-AR	3M
J5	1	CONN HEADER VERT SGL 3 X 1 POS GOLD	961103-6404-AR	3M
J1, J2, J3	3	Edge Launch SMA (0.375 inch pitch ground, tab)	142-0701-851	Emerson Johnson
U1	1	AMP	F1420NLGK	IDT
	1	Printed Circuit Board	F1420 EVKit REV 1	IDT
C2, C5		DNP	GRM1555C1H470J	Murata

## Evaluation Kit Operation

### Power Supply Setup

Set up a power supply in the voltage range of 3.0V to 5.25V with the power supply output disabled. The voltage can be applied via one of the following connections (see Figure 18):

- J3 connector
- J4 header connection (note the polarity of the GND pin on this connector)

**Figure 18. Power Supply Connections**

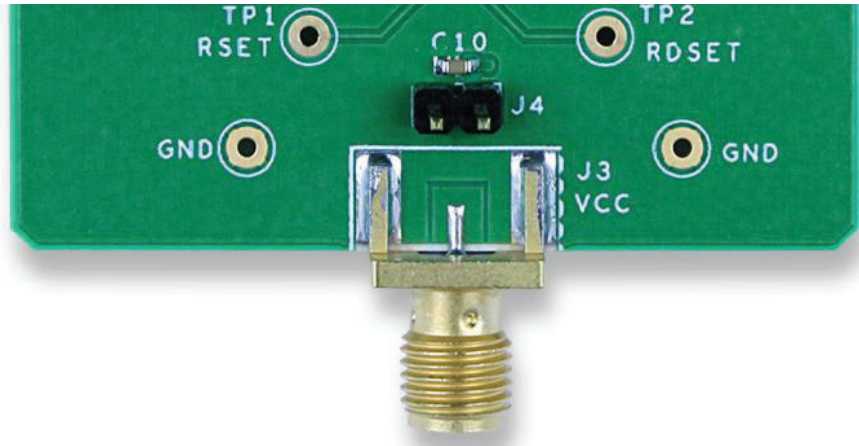

### Standby (STBY) Pin

The Evaluation Board has the ability to control the F1420 for standby operation. The logic voltage is applied to the J5 header connection as shown in Figure 19.

To place the amplifier in the active mode (on) use one of these options:

- Make no connections on J5
- Apply a logic LOW signal to STBY (pin 2 of J5 or the middle pin).
- Make a connection between pins 1 (GND) and STBY (pin 2 of J5 or the middle pin).

To place the amplifier in the standby mode (off) use one of these options:

- Apply a logic HIGH signal to STBY (pin 2 of J5 or the middle pin).
- Make a connection between pins 3 (VCC) and STBY (pin 2 of J5 or the middle pin).

**Figure 19. Standby Pin Connection**

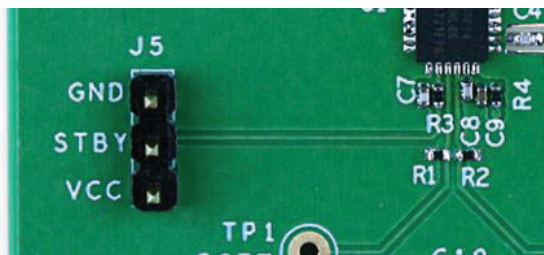

## Power-On Procedure

Set up the voltage supplies and Evaluation Board as described in the "Power Supply Setup" section and set the "Standby Pin" or logic LOW.

- Enable the power supply.
- The STBY pin now can now be exercised.

## Power-Off Procedure

- Set the STBY pin for logic LOW.
- Disable the power supply.

## Application Information

The F1420 has been optimized for use in high performance RF applications from 700MHz to 1100MHz.

### Standby Mode (STBY)

The F1420 has a standby pin that allows the amplifier to be turned off to decrease overall power requirements. The pin uses simple logic levels and is compatible with both JECEC 1.8V and JEDEC 3.3V logic. Table 7 lists the amplifier state for the logic. An internal pull-down resistor causes the amplifier to default to the on state.

**Table 7. Standby Truth Table**

STBY (pin 8)	Condition
LOW or Open	Amplifier On
HIGH	Amplifier Off

### RSET and RDSET

The F1420 has been optimized for gain and intermodulation products by adjusting the bias resistors RSET and RDSET. For the optimized setting, the values are RSET (R1) is 2.26kΩ and RDSET (R2) is 5.76kΩ.

### Power Supplies

The power supply pin should be bypassed with external capacitors to minimize noise and fast transients. Supply noise can degrade noise figure and fast transients can trigger ESD clamps and cause them to fail. Supply voltage change or transients should have a slew rate smaller than 1V/20μs.

### Control Pin Interface

If control signal integrity is a concern and clean signals cannot be guaranteed due to overshoot, undershoot, ringing, etc., the following circuit at the input of each control pin is recommended. This applies to control pin 8 (STBY). Note the recommended resistor and capacitor values do not necessarily match the EVKit BOM for the case of poor control signal integrity.

**Figure 20. Control Pin Interface for Signal Integrity**

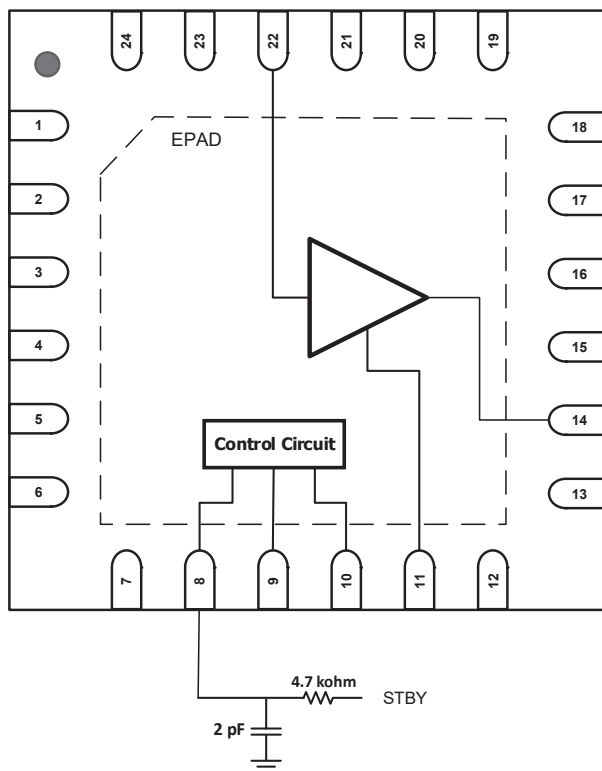

### Digital Pin Voltage and Resistance Values

Table 8 provides the open-circuit DC voltage referenced to ground and resistance value for the control pin listed.

**Table 8. Digital Pin Voltages and Resistance**

Pin	Name	Open Circuit DC Voltage	Internal Connection
8	STBY	0V	580kΩ resistor to ground

## **Package Outline Drawings**

The package outline drawings and land pattern are located at the end of this document. The package information is the most current data available and is subject to change without notice or revision of this document.

## Ordering Information

Orderable Part Number	Package	MSL Rating	Shipping Packaging	Temperature
F1420NLGK	4mm x 4mm x 0.9mm 24-pin QFN (NLG24P1)	1	Tray	-40° to +105°C
F1420NLGK8	4mm x 4mm x 0.9mm 24-pin QFN (NLG24P1)	1	Reel	-40° to +105°C
F1420EVBI	Evaluation Board			

## Marking Diagram



Line 1 and 2 are the part number.  
 Line 3 "ZA" is for die version.  
 Line 3 "721" is one digit for the year and week that the part was assembled.  
 Line 3 "FTG" denotes the production process.



## Revision History

Revision	Revision Date	Description of Change
0	January 23, 2018	Initial release of the datasheet

DATE CREATED		REVISIONS		AUTHOR	
REV	DESCRIPTION	REV	DESCRIPTION	REV	DESCRIPTION
00	INITIAL RELEASE	00	INITIAL RELEASE	J.H	J.H
01	ADD CHAMFER ON EPAD	01	ADD CHAMFER ON EPAD	J.H	J.H

REFER TO DCP FOR OFFICIAL RELEASE DATE

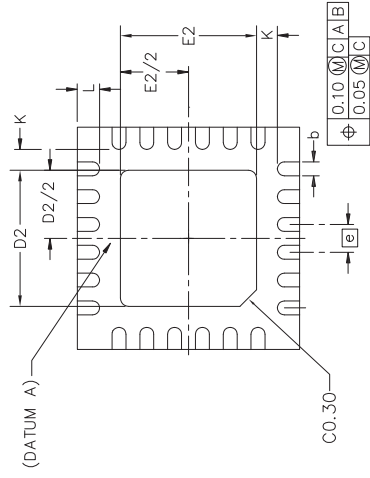
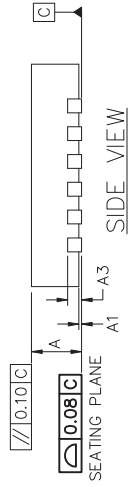
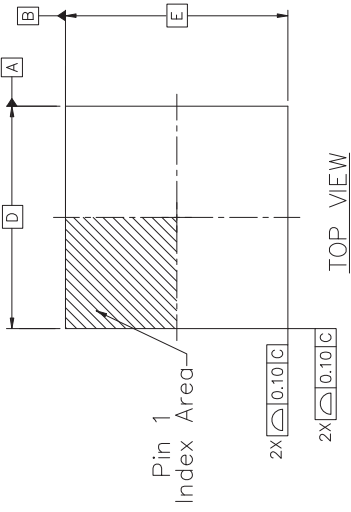

SYMBOL	DIMENSIONS		
	MIN.	NOM.	MAX.
A	0.80	0.90	1.00
A1	0.00	0.02	0.05
A3	0.20 REF		
K	0.375		
D	4.00 BSC		
E	4.00 BSC		
D2	2.30	2.45	2.60
E2	2.30	2.45	2.60
e	0.50 BSC		
L	0.30	0.40	0.50
b	0.18	0.25	0.30

NOTES :

1. DIMENSIONING AND TOLERANCING CONFORME TO ASME Y14.5M - 1994.
2. ALL DIMENSIONS ARE IN MILLIMETERS.

TOLERANCES UNLESS SPECIFIED DECIMAL XX± XXX± XXXX±	<p>6024 Silver Creek Valley Road San Jose, CA 95138 PHONE: (408) 284-8200 FAX: (408) 284-8591</p> <p>www.IDT.com</p>
ANGULAR ±	TITLE NL/NLG24P1 PACKAGE OUTLINE
	4.0 x 4.0 mm BODY 0.5 mm PITCH QFN
SIZE C	DRAWING No. PSC-4192-01
REV C	REV 01
DO NOT SCALE DRAWING	
SHEET 1 OF 2	

DATE CREATED		REVISIONS		AUTHOR	
11/17/15	00	INITIAL RELEASE		J.H	
9/9/16	01	ADD CHAMFER ON EPAD		J.H	
REFER TO DCP FOR OFFICIAL RELEASE DATE					

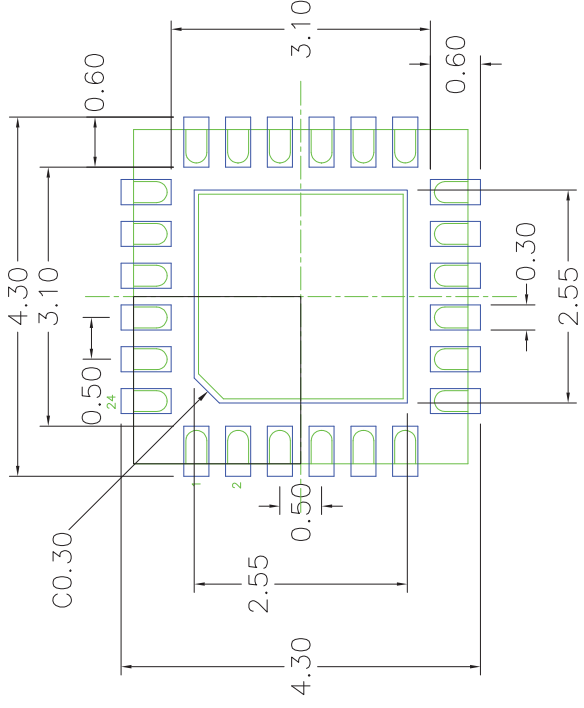

RECOMMENDED LAND PATTERN DIMENSION

NOTES:

1. ALL DIMENSIONS ARE IN mm. ANGLES IN DEGREES.
2. TOP DOWN VIEW, AS VIEWED ON PCB.
3. COMPONENT OUTLINE SHOWS FOR REFERENCE IN GREEN.
4. LAND PATTERN IN BLUE. NSMD PATTERN ASSUMED.
5. LAND PATTERN RECOMMENDATION PER IPC-7351B GENERIC REQUIREMENT FOR SURFACE MOUNT DESIGN AND LAND PATTERN.

TOLERANCES UNLESS SPECIFIED DECIMAL XXX± XXXX±	ANGULAR ° XXX±	<b>IDT</b> 6024 Silver Creek Valley Road San Jose, CA 95138 PHONE: (408) 284-8200 FAX: (408) 284-8591 WWW.IDT.COM	TITLE NL/NLG24P1 PACKAGE OUTLINE SIZE 4.0 x 4.0 mm BODY 0.5 mm PITCH QFN DRAWING No. PSC-4192-01 REV 01
DO NOT SCALE DRAWING			SHEET 2 OF 2