

RONDA-O-C

~50° + 30° oval beam with holder C compatible
with LEDiL HEKLA

TECHNICAL SPECIFICATIONS:

Dimensions	Ø 53.9 mm
Height	20.5 mm
Fastening	socket
ROHS compliant	yes ⓘ

MATERIAL SPECIFICATIONS:

Component	Type	Material	Colour	Finish
F15990_RONDA-O	Single lens	PMMA	clear	
F15635_RONDA-HLD-C	Holder	PC	white	

ORDERING INFORMATION:

Quantities for one set:

Single lens	1
Holder	1





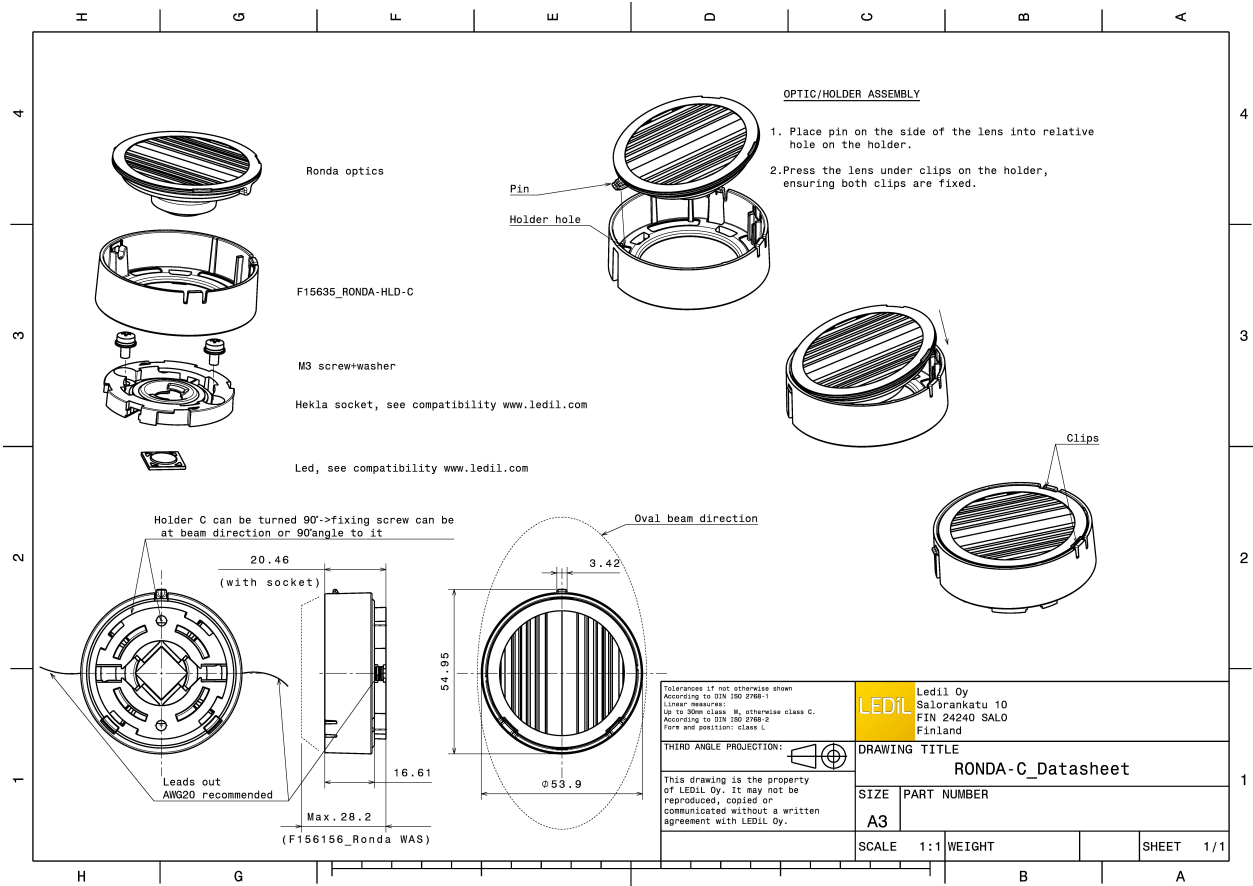





Component		Qty in box	MOQ	MPQ	Box weight (kg)
F15990_RONDA-O	Single lens	420	120	30	6.5
» Box size: 480 x 280 x 300 mm					
F15635_RONDA-HLD-C	Holder	420	120	30	4.1
» Box size: 480 x 280 x 300 mm					

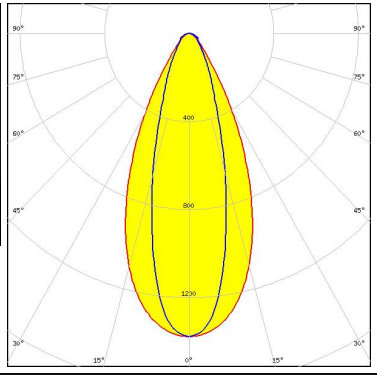

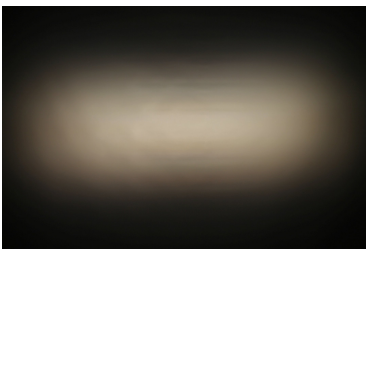
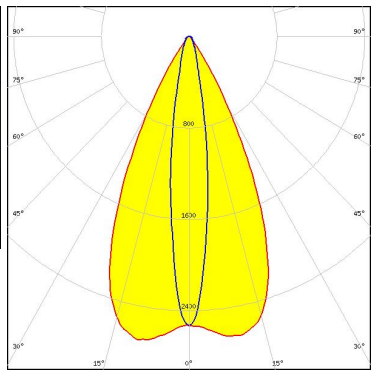

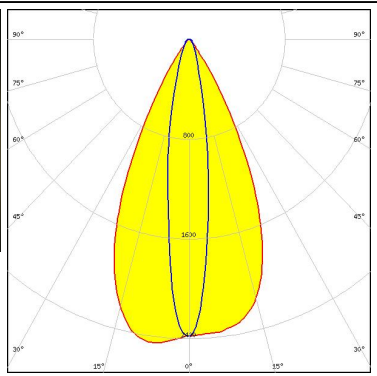

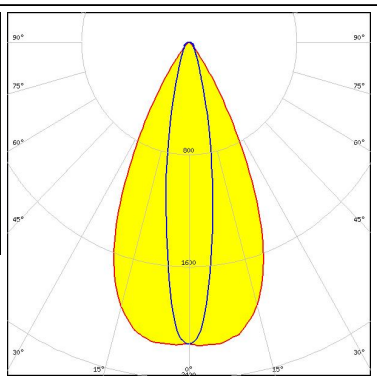

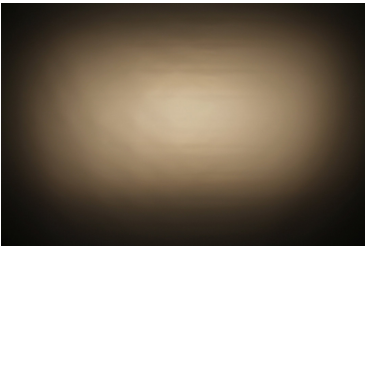
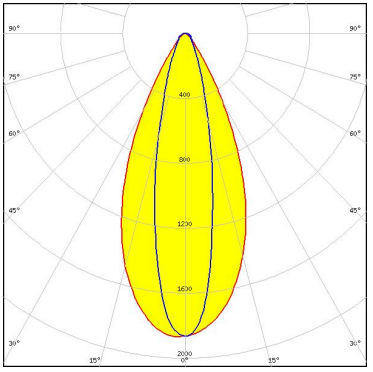

See also our general installation guide: www.ledil.com/installation_guide

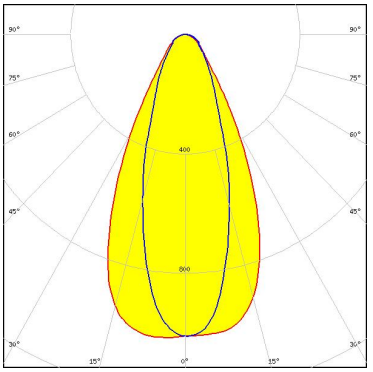

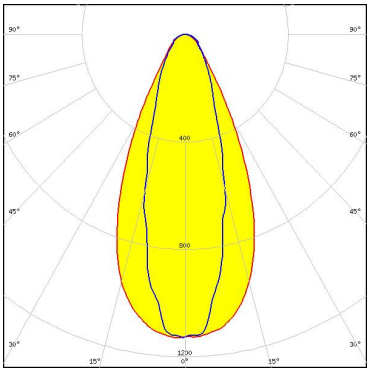
PHOTOMETRIC DATA (MEASURED):

<p></p> <p>LED V11 HD Gen 8</p> <p>FWHM / FWTM 48.0 + 29.0° / 80.0 + 68.0°</p> <p>Efficiency 83 %</p> <p>Peak intensity 1.4 cd/lm</p> <p>LEDs/each optic 1</p> <p>Light colour White</p> <p>Required components: Bender Wirth: 633d Hekla</p>		
<p></p> <p>LED V4 HD Gen 7</p> <p>FWHM / FWTM 51.0 + 16.0° / 70.0 + 35.0°</p> <p>Efficiency 92 %</p> <p>Peak intensity 2.7 cd/lm</p> <p>LEDs/each optic 1</p> <p>Light colour White</p> <p>Required components: F15253_HEKLA-SOCKET-A</p>		
<p></p> <p>LED V6 Gen6</p> <p>FWHM / FWTM 50.0 + 17.0° / 72.0 + 40.0°</p> <p>Efficiency 91 %</p> <p>Peak intensity 2.4 cd/lm</p> <p>LEDs/each optic 1</p> <p>Light colour White</p> <p>Required components: F15253_HEKLA-SOCKET-A</p>		
<p></p> <p>LED V6 HD Gen 7</p> <p>FWHM / FWTM 51.0 + 19.0° / 73.0 + 43.0°</p> <p>Efficiency 91 %</p> <p>Peak intensity 2.2 cd/lm</p> <p>LEDs/each optic 1</p> <p>Light colour White</p> <p>Required components: F15255_HEKLA-SOCKET-C</p>		

PHOTOMETRIC DATA (MEASURED):

<p></p> <p>LED V9 HD Gen7</p> <p>FWHM / FWTM 47.0 + 23.0° / 74.0 + 54.0°</p> <p>Efficiency 89 %</p> <p>Peak intensity 1.9 cd/lm</p> <p>LEDs/each optic 1</p> <p>Light colour White</p> <p>Required components: F15859_HEKLA-SOCKET-I</p>		
<p></p> <p>LED Vesta DTW 13mm (21W)</p> <p>FWHM / FWTM 53.0 + 35.0° / 89.0 + 84.0°</p> <p>Efficiency 80 %</p> <p>Peak intensity 1 cd/lm</p> <p>LEDs/each optic 1</p> <p>Light colour Tunable White</p> <p>Required components: C16142_HEKLA-SOCKET-K Bender Wirth: 491 Typ L8</p>		
<p></p> <p>LED Vesta TW 13mm (25W) CSP</p> <p>FWHM / FWTM 50.0 + 31.0° / 85.0 + 81.0°</p> <p>Efficiency 82 %</p> <p>Peak intensity 1.1 cd/lm</p> <p>LEDs/each optic 1</p> <p>Light colour White</p> <p>Required components: C16142_HEKLA-SOCKET-K Bender Wirth: 492 Typ L8</p>		
<p></p> <p>LED Vesta TW 6mm DP</p> <p>FWHM / FWTM 48.0 + 19.0° / 71.0 + 45.0°</p> <p>Efficiency 85 %</p> <p>Peak intensity 2.1 cd/lm</p> <p>LEDs/each optic 1</p> <p>Light colour White</p> <p>Required components: C16142_HEKLA-SOCKET-K Bender Wirth: 504 Typ L8</p>		

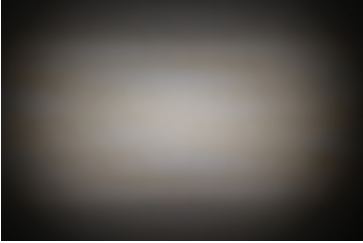
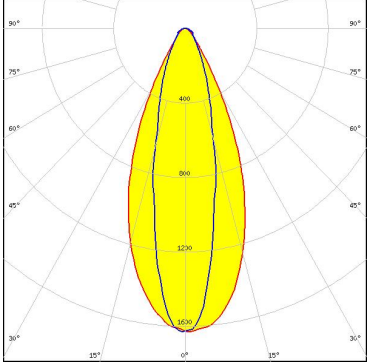
PHOTOMETRIC DATA (MEASURED):

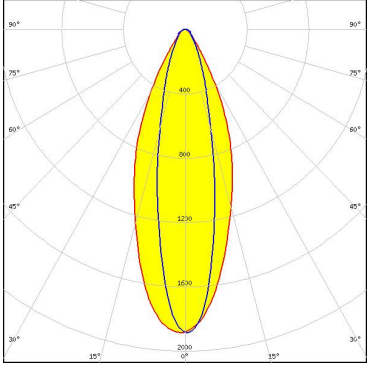
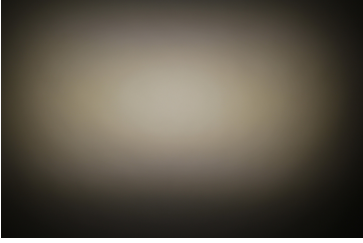
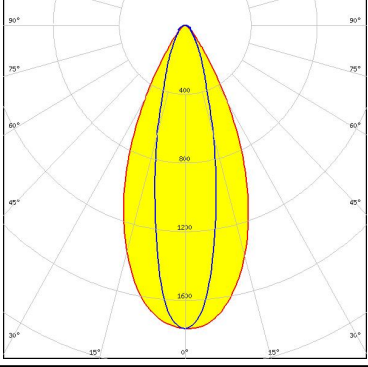
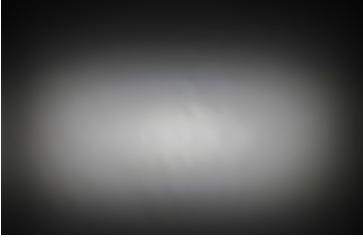
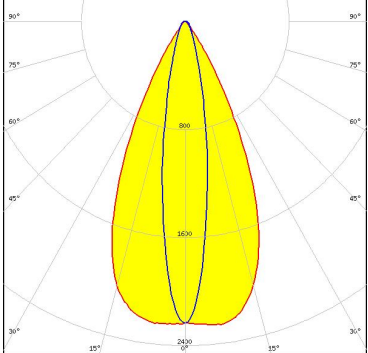
<p></p> <p>LED Vesta TW 9mm (12W) CSP FWHM / FWTM 44.0 + 25.0° / 73.0 + 64.0° Efficiency 85 % Peak intensity 1.6 cd/lm LEDs/each optic 1 Light colour White Required components: C16142_HEKLA-SOCKET-K</p>		
<p>CITIZEN</p> <p>LED CLC020 Series (Dim-To-Warm) FWHM / FWTM 29.0 + 23.0° / 72.0 + 57.0° Efficiency 84 % Peak intensity 1.9 cd/lm LEDs/each optic 1 Light colour White Required components: C16142_HEKLA-SOCKET-K</p>		
<p>CITIZEN</p> <p>LED CLL02x/CLU02x (LES10) FWHM / FWTM 47.0 + 24.0° / 75.0 + 58.0° Efficiency 88 % Peak intensity 1.8 cd/lm LEDs/each optic 1 Light colour White Required components: F15255_HEKLA-SOCKET-C</p>		
<p>CITIZEN</p> <p>LED CLU700/701/702 FWHM / FWTM 50.0 + 18.0° / 71.0 + 43.0° Efficiency 90 % Peak intensity 2.3 cd/lm LEDs/each optic 1 Light colour White Required components: F15255_HEKLA-SOCKET-C</p>		

PHOTOMETRIC DATA (MEASURED):

CITIZEN

LED CLU7A2 (LES 4.2mm)
 FWHM / FWTM 49.0 + 14.0° / 68.0 + 31.0°
 Efficiency 91 %
 Peak intensity 3 cd/m
 LEDs/each optic 1
 Light colour White
 Required components:
 F15255_HEKLA-SOCKET-C

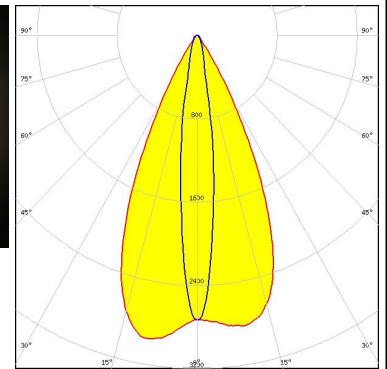
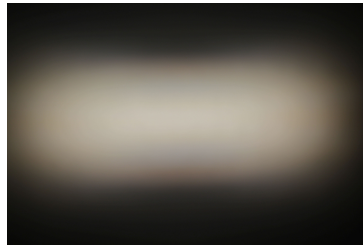

CREE LED

LED CMA1516
 FWHM / FWTM 49.0 + 25.0° / 76.0 + 57.0°
 Efficiency 91 %
 Peak intensity 1.8 cd/m
 LEDs/each optic 1
 Light colour White
 Required components:
 F15256_HEKLA-SOCKET-D

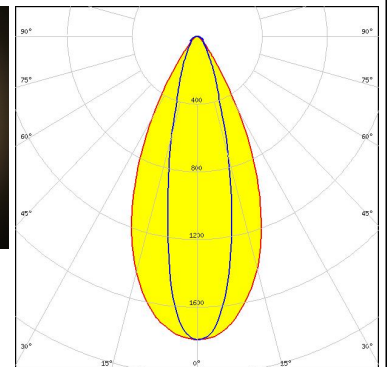
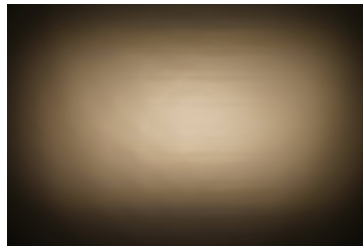

CREE LED

LED CMA1825
 FWHM / FWTM 51.0 + 33.0° / 83.0 + 76.0°
 Efficiency 88 %
 Peak intensity 1.3 cd/m
 LEDs/each optic 1
 Light colour White
 Required components:
 F15254_HEKLA-SOCKET-B

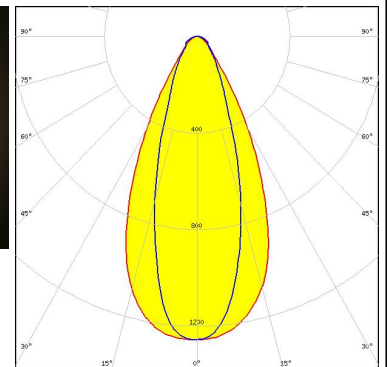
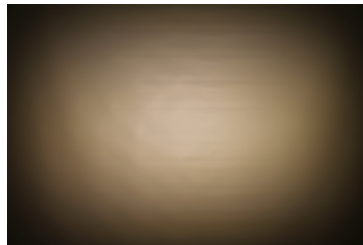

CREE LED

LED CMT14xx
 FWHM / FWTM 48.0 + 26.0° / 77.0 + 60.0°
 Efficiency 90 %
 Peak intensity 1.7 cd/m
 LEDs/each optic 1
 Light colour White
 Required components:
 F15255_HEKLA-SOCKET-C

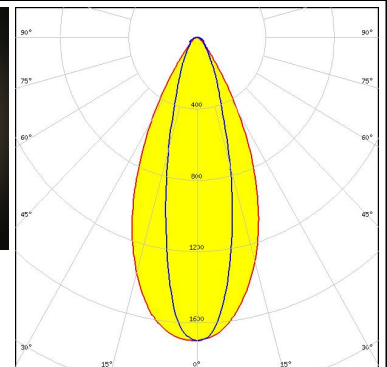
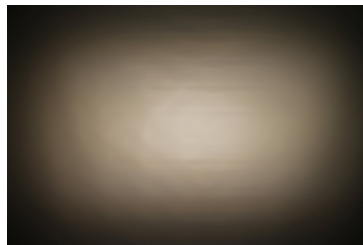

PHOTOMETRIC DATA (MEASURED):

CREE LED

LED CMT19xx
 FWHM / FWTM 54.0 + 38.0° / 92.0 + 88.0°
 Efficiency 84 %
 Peak intensity 1 cd/lm
 LEDs/each optic 1
 Light colour White
 Required components:
 F15859_HEKLA-SOCKET-I

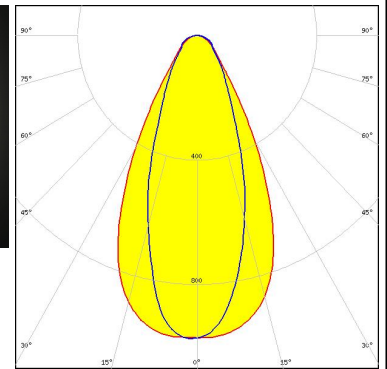
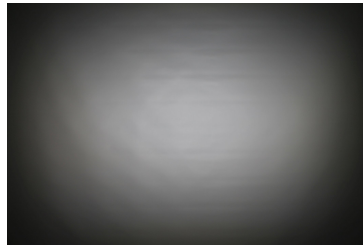

CREE LED

LED CXA/B 13xx
 FWHM / FWTM 50.0 + 17.0° / 72.0 + 40.0°
 Efficiency 91 %
 Peak intensity 2.4 cd/lm
 LEDs/each optic 1
 Light colour White
 Required components:
 F15956_HEKLA-SOCKET-J

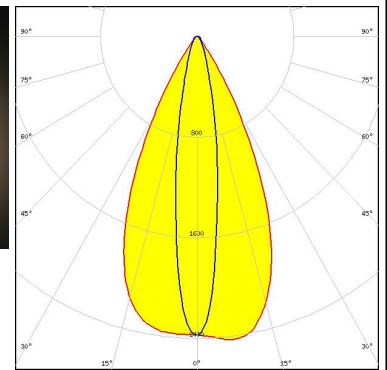
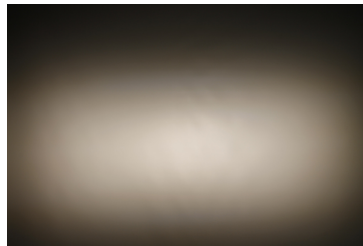

CREE LED

LED CXA/B 15xx
 FWHM / FWTM 49.0 + 23.0° / 75.0 + 54.0°
 Efficiency 90 %
 Peak intensity 1.9 cd/lm
 LEDs/each optic 1
 Light colour White
 Required components:
 F15256_HEKLA-SOCKET-D

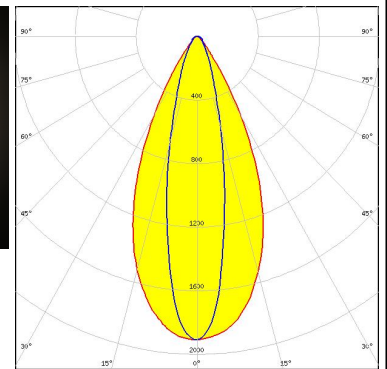
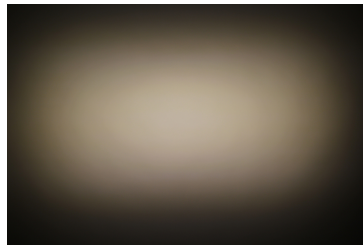

LUMILEDS



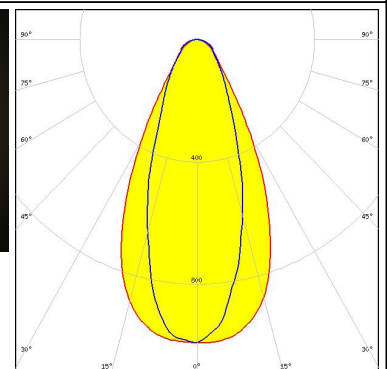
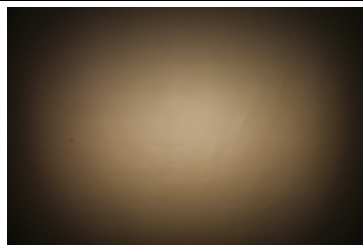

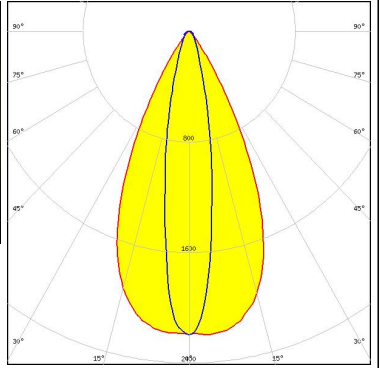
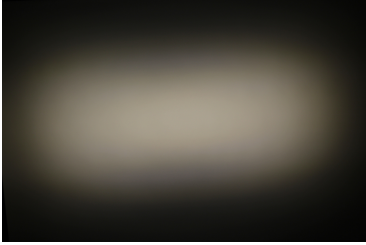
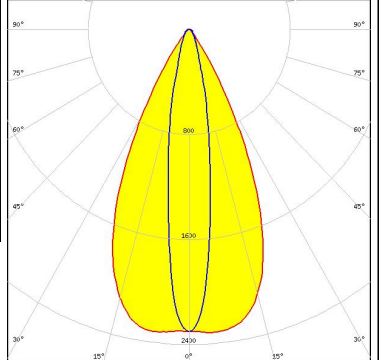
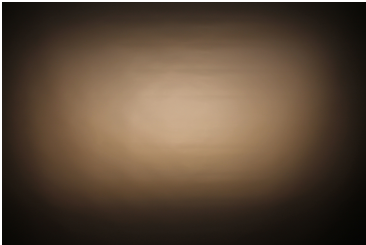
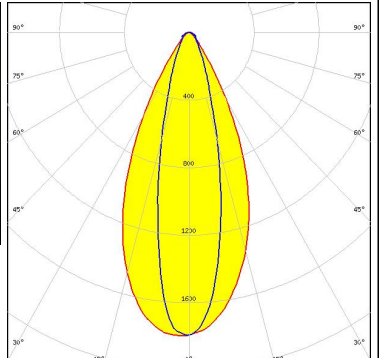
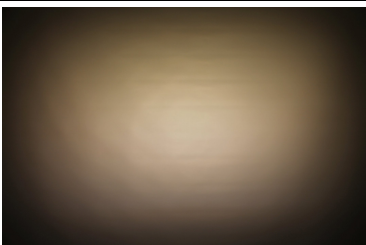
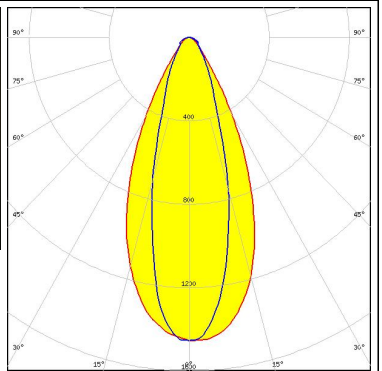

LED LUXEON CX Plus CoB L08 (Gen2)
 FWHM / FWTM 54.0 + 38.0° / 93.0 + 90.0°
 Efficiency 85 %
 Peak intensity 1 cd/lm
 LEDs/each optic 1
 Light colour White
 Required components:
 Bender Wirth: 637a Hekla

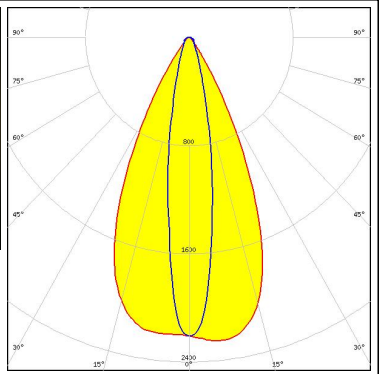

PHOTOMETRIC DATA (MEASURED):

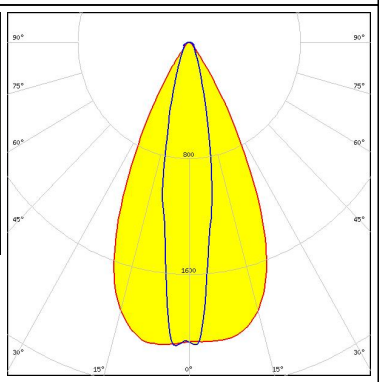
<p>LUMILEDS</p> <p>LED LUXEON CoB 1202HD</p> <p>FWHM / FWTM 51.0 + 18.0° / 73.0 + 43.0°</p> <p>Efficiency 91 %</p> <p>Peak intensity 2.2 cd/lm</p> <p>LEDs/each optic 1</p> <p>Light colour White</p> <p>Required components: F15848_HEKLA-SOCKET-G</p>		
<p>LUMILEDS</p> <p>LED LUXEON CoB 1202s</p> <p>FWHM / FWTM 51.0 + 17.0° / 72.0 + 40.0°</p> <p>Efficiency 91 %</p> <p>Peak intensity 2.3 cd/lm</p> <p>LEDs/each optic 1</p> <p>Light colour White</p> <p>Required components: F15848_HEKLA-SOCKET-G</p>		
<p>LUMILEDS</p> <p>LED LUXEON CoB 1204HD</p> <p>FWHM / FWTM 48.0 + 25.0° / 76.0 + 56.0°</p> <p>Efficiency 91 %</p> <p>Peak intensity 1.8 cd/lm</p> <p>LEDs/each optic 1</p> <p>Light colour White</p> <p>Required components: F15858_HEKLA-SOCKET-H</p>		
<p>LUMILEDS</p> <p>LED LUXEON CoB 1205HD</p> <p>FWHM / FWTM 48.0 + 30.0° / 79.0 + 68.0°</p> <p>Efficiency 88 %</p> <p>Peak intensity 1.5 cd/lm</p> <p>LEDs/each optic 1</p> <p>Light colour White</p> <p>Required components: F15858_HEKLA-SOCKET-H</p>		

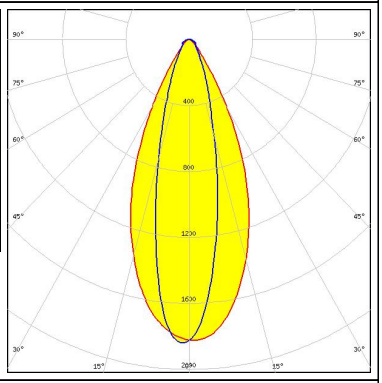
PHOTOMETRIC DATA (MEASURED):

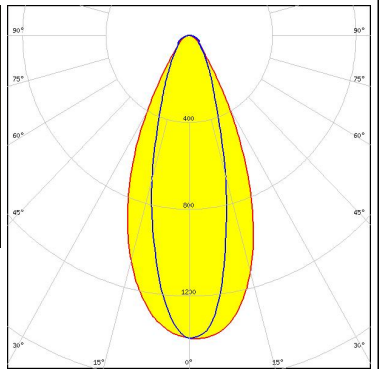
<p>LUMILEDS</p> <p>LED LUXEON CX Plus CoB - HD S01H4</p> <p>FWHM / FWTM 50.0 + 18.0° / 72.0 + 43.0°</p> <p>Efficiency 90 %</p> <p>Peak intensity 2.3 cd/lm</p> <p>LEDs/each optic 1</p> <p>Light colour White</p> <p>Required components: Bender Wirth: 634c Hekla</p>		
<p>LUMILEDS</p> <p>LED LUXEON CX Plus CoB - HD S01H6 / HD S02H6</p> <p>FWHM / FWTM 51.0 + 20.0° / 72.0 + 45.0°</p> <p>Efficiency 91 %</p> <p>Peak intensity 2.1 cd/lm</p> <p>LEDs/each optic 1</p> <p>Light colour White</p> <p>Required components: Bender Wirth: 634c Hekla</p>		
<p>LUMILEDS</p> <p>LED LUXEON CX Plus CoB - HD S04H9</p> <p>FWHM / FWTM 46.0 + 25.0° / 75.0 + 58.0°</p> <p>Efficiency 90 %</p> <p>Peak intensity 1.8 cd/lm</p> <p>LEDs/each optic 1</p> <p>Light colour White</p> <p>Required components: Bender Wirth: 634c Hekla</p>		
<p>LUMILEDS</p> <p>LED LUXEON CX Plus CoB L04 / L05 (Gen2)</p> <p>FWHM / FWTM 48.0° / 79.0 + 72.0°</p> <p>Efficiency 88 %</p> <p>Peak intensity 1.4 cd/lm</p> <p>LEDs/each optic 1</p> <p>Light colour White</p> <p>Required components: Bender Wirth: 637a Hekla</p>		

PHOTOMETRIC DATA (MEASURED):

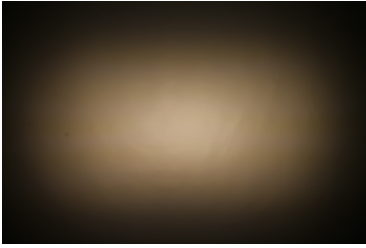
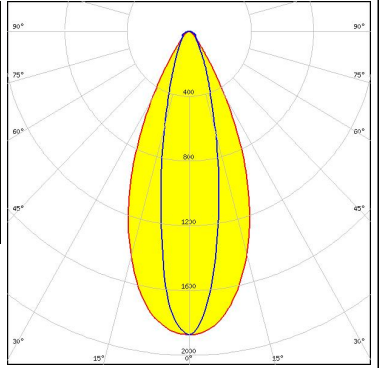
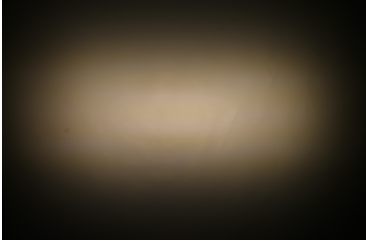
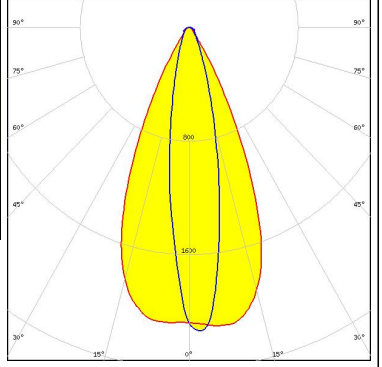
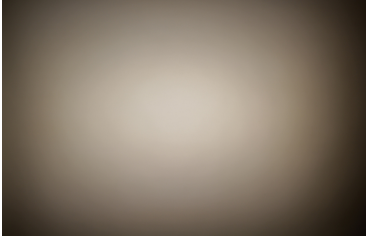
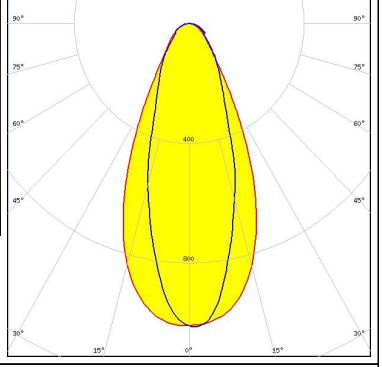
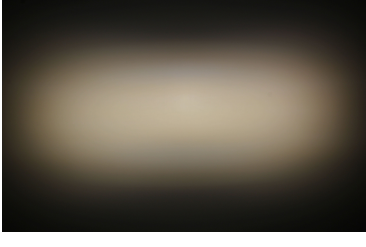
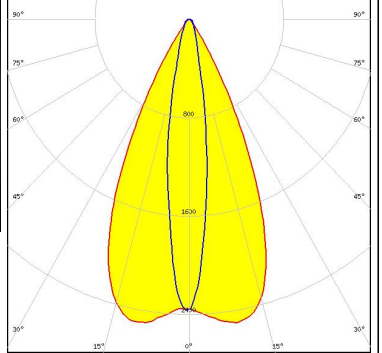
<p>LUMILEDS</p> <p>LED LUXEON CX Plus CoB M02 / M03 (Gen2)</p> <p>FWHM / FWTM 46.0 + 23.0° / 74.0 + 56.0°</p> <p>Efficiency 90 %</p> <p>Peak intensity 1.9 cd/lm</p> <p>LEDs/each optic 1</p> <p>Light colour White</p> <p>Required components: Bender Wirth: 641a Hekla</p>		
<p>LUMILEDS</p> <p>LED LUXEON CX Plus CoB S01 (Gen2)</p> <p>FWHM / FWTM 48.0 + 20.0° / 68.0 + 47.0°</p> <p>Efficiency 89 %</p> <p>Peak intensity 2.2 cd/lm</p> <p>LEDs/each optic 1</p> <p>Light colour White</p> <p>Required components: Bender Wirth: 634c Hekla</p>		
<p>LUMINUS</p> <p>LED CxM-14 (19x19)</p> <p>FWHM / FWTM 49.0 + 35.0° / 89.0 + 88.0°</p> <p>Efficiency 79 %</p> <p>Peak intensity 1 cd/lm</p> <p>LEDs/each optic 1</p> <p>Light colour White</p> <p>Required components: F15859_HEKLA-SOCKET-I</p>		
<p>LUMINUS</p> <p>LED CXM-4</p> <p>FWHM / FWTM 51.0 + 16.0° / 70.0 + 37.0°</p> <p>Efficiency 90 %</p> <p>Peak intensity 2.5 cd/lm</p> <p>LEDs/each optic 1</p> <p>Light colour White</p> <p>Required components: F15255_HEKLA-SOCKET-C</p>		

PHOTOMETRIC DATA (MEASURED):

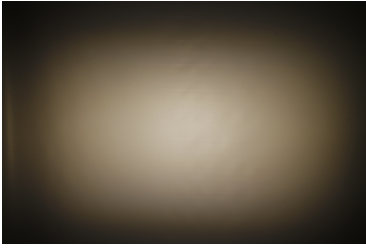
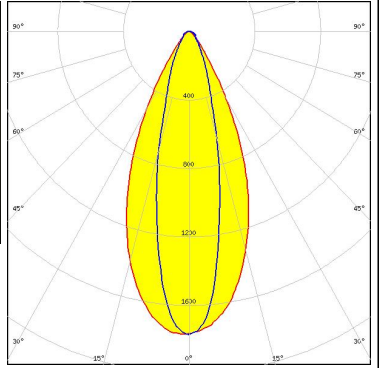
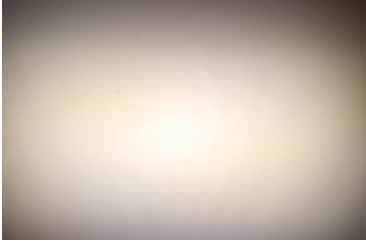
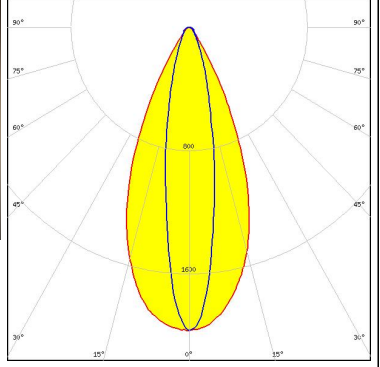
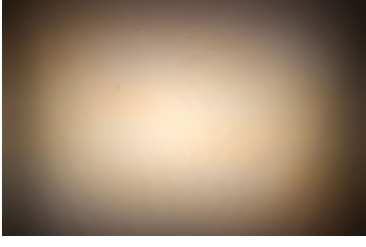
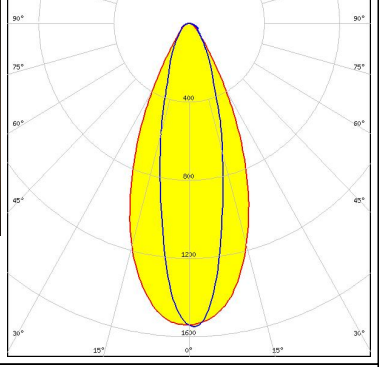
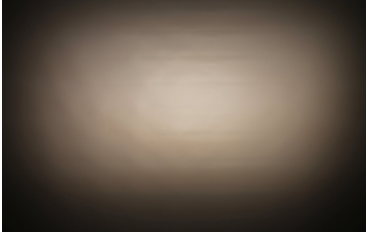
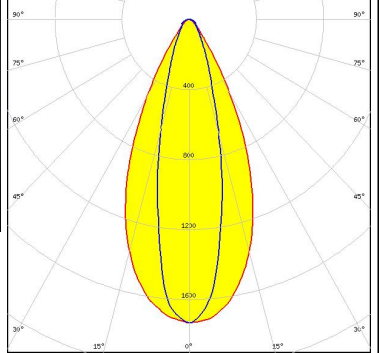
<p>LUMINUS</p> <p>LED CxM-9 (13.5x13.5)</p> <p>FWHM / FWTM 47.0 + 25.0° / 75.0 + 59.0°</p> <p>Efficiency 89 %</p> <p>Peak intensity 1.8 cd/lm</p> <p>LEDs/each optic 1</p> <p>Light colour White</p> <p>Required components: F15255_HEKLA-SOCKET-C</p>		
<p>NICHIA</p> <p>LED NJCWL024Z-V1MT: COB L-Type Tunable White</p> <p>FWHM / FWTM 46.0 + 20.0° / 70.0 + 50.0°</p> <p>Efficiency 82 %</p> <p>Peak intensity 1.9 cd/lm</p> <p>LEDs/each optic 1</p> <p>Light colour White</p> <p>Required components: C16142_HEKLA-SOCKET-K Bender Wirth: 497 Typ L8</p>		
<p>NICHIA</p> <p>LED NVCWJ024Z-V1MT: COB J-Type Tunable White</p> <p>FWHM / FWTM 45.0 + 25.0° / 75.0 + 67.0°</p> <p>Efficiency 84 %</p> <p>Peak intensity 1.6 cd/lm</p> <p>LEDs/each optic 1</p> <p>Light colour White</p> <p>Required components: C16142_HEKLA-SOCKET-K Bender Wirth: 498 Typ L8</p>		
<p>PHILIPS</p> <p>LED Fortimo SLM L09 CoB</p> <p>FWHM / FWTM 48.0 + 25.0° / 76.0 + 58.0°</p> <p>Efficiency 90 %</p> <p>Peak intensity 1.7 cd/lm</p> <p>LEDs/each optic 1</p> <p>Light colour White</p> <p>Required components: F15858_HEKLA-SOCKET-H</p>		

PHOTOMETRIC DATA (MEASURED):

PHILIPS

LED Fortimo SLM L13 CoB
 FWHM / FWTM 41.0 + 45.0° / 90.0 + 89.0°
 Efficiency 83 %
 Peak intensity 1 cd/lm
 LEDs/each optic 1
 Light colour White
 Required components:
 C16142_HEKLA-SOCKET-K
 Bender Wirth: 432 Typ L8

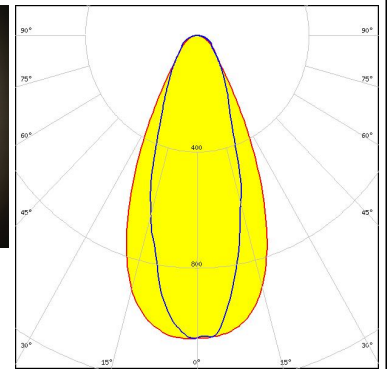

SAMSUNG

LED LC003D / LC006D / LC009D / LC013D
 FWHM / FWTM 48.0 + 25.0° / 76.0 + 60.0°
 Efficiency 89 %
 Peak intensity 1.7 cd/lm
 LEDs/each optic 1
 Light colour White
 Required components:
 F15255_HEKLA-SOCKET-C

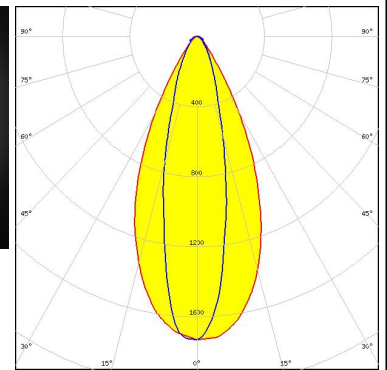
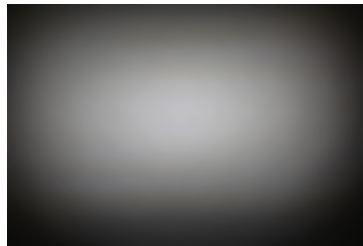

SAMSUNG

LED LC010C
 FWHM / FWTM 52.0 + 18.0° / 74.0 + 44.0°
 Efficiency 90 %
 Peak intensity 2.1 cd/lm
 LEDs/each optic 1
 Light colour White
 Required components:
 F15848_HEKLA-SOCKET-G

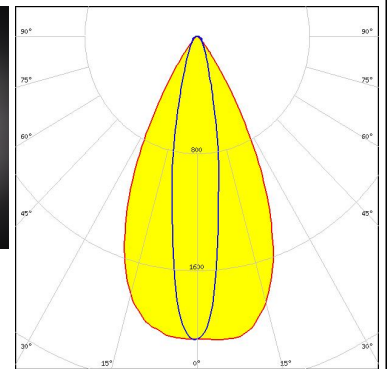
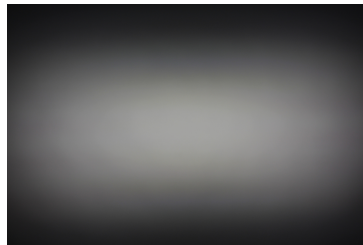

SAMSUNG

LED LC010C G2
 FWHM / FWTM 50.0 + 17.0° / 71.0 + 41.0°
 Efficiency 89 %
 Peak intensity 2.3 cd/lm
 LEDs/each optic 1
 Light colour White
 Required components:
 F15255_HEKLA-SOCKET-C

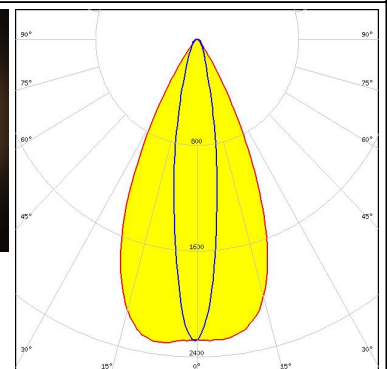
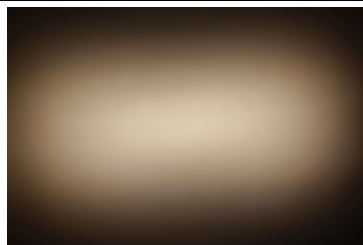

PHOTOMETRIC DATA (MEASURED):

SAMSUNG

LED LC016D / LC019D / LC026D / LC033D
 FWHM / FWTM 55.0 + 37.0° / 94.0 + 89.0°
 Efficiency 82 %
 Peak intensity 1 cd/m
 LEDs/each optic 1
 Light colour White
 Required components:
 F15859_HEKLA-SOCKET-I

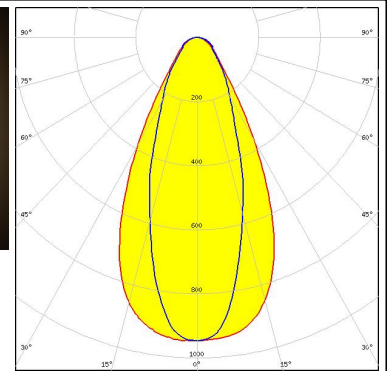
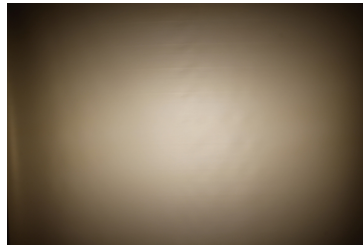

SAMSUNG

LED LC020C
 FWHM / FWTM 49.0 + 22.0° / 75.0 + 52.0°
 Efficiency 90 %
 Peak intensity 1.9 cd/m
 LEDs/each optic 1
 Light colour White
 Required components:
 F15848_HEKLA-SOCKET-G

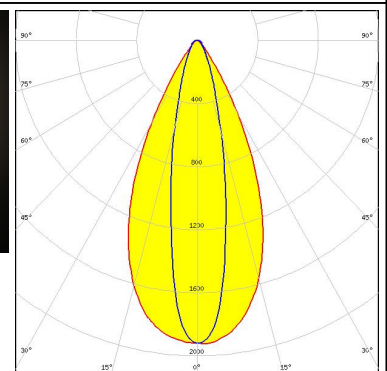
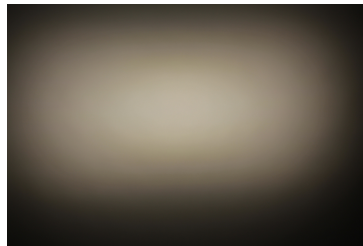

SAMSUNG

LED LC020C G2
 FWHM / FWTM 47.0 + 23.0° / 74.0 + 55.0°
 Efficiency 88 %
 Peak intensity 1.9 cd/m
 LEDs/each optic 1
 Light colour White
 Required components:
 F15859_HEKLA-SOCKET-I

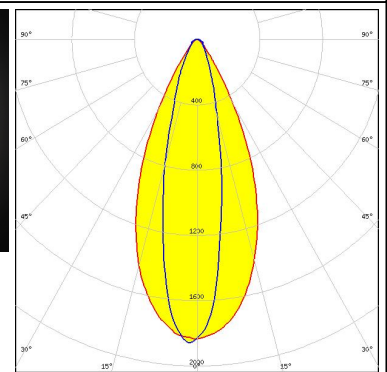
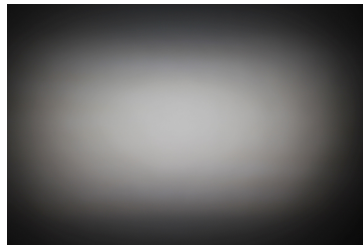

TRIDONIC

LED SLE G7 LES09
 FWHM / FWTM 46.0 + 24.0° / 74.0 + 57.0°
 Efficiency 88 %
 Peak intensity 1.8 cd/m
 LEDs/each optic 1
 Light colour White
 Required components:
 F15255_HEKLA-SOCKET-C

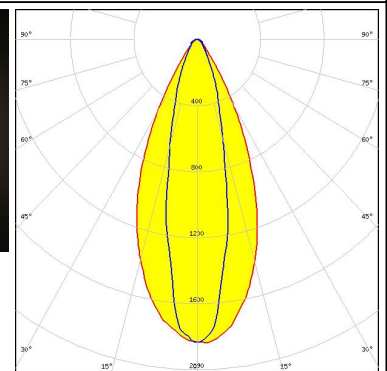
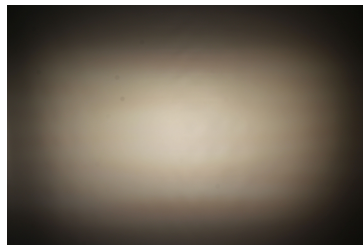

PHOTOMETRIC DATA (MEASURED):

TRIDONIC

LED SLE G7 LES13
 FWHM / FWTM 52.0 + 35.0° / 85.0 + 81.0°
 Efficiency 84 %
 Peak intensity 1.1 cd/lm
 LEDs/each optic 1
 Light colour White
 Required components:
 F15859_HEKLA-SOCKET-I

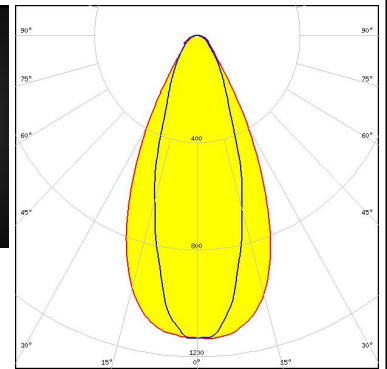

TRIDONIC

LED SLE G7 LES15
 FWHM / FWTM 55.0 + 39.0° / 94.0 + 90.0°
 Efficiency 83 %
 Peak intensity 1 cd/lm
 LEDs/each optic 1
 Light colour White
 Required components:
 F15859_HEKLA-SOCKET-I

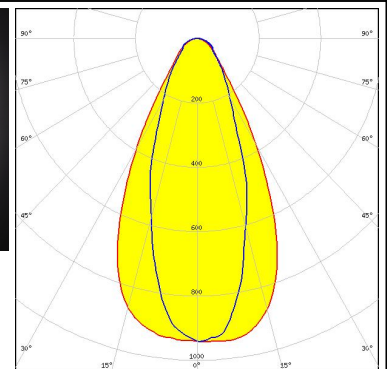
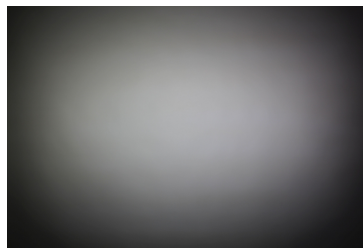

XICATO

LED XOB 14.5 mm
 FWHM / FWTM 54.0 + 36.0° / 88.0 + 84.0°
 Efficiency 83 %
 Peak intensity 1 cd/lm
 LEDs/each optic 1
 Light colour White
 Required components:
 F15859_HEKLA-SOCKET-I

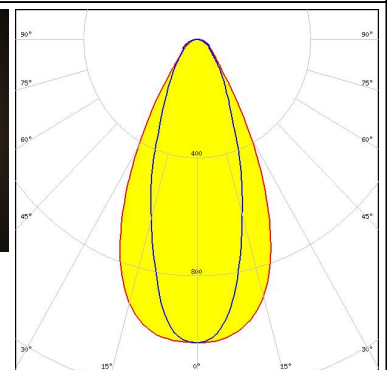
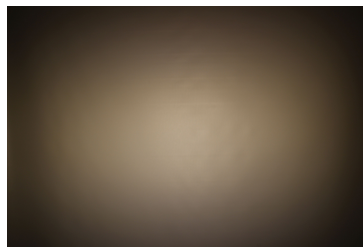

XICATO

LED XOB 9.8 mm
 FWHM / FWTM 48.0 + 24.0° / 76.0 + 89.0°
 Efficiency 89 %
 Peak intensity 1.8 cd/lm
 LEDs/each optic 1
 Light colour White
 Required components:
 F15255_HEKLA-SOCKET-C

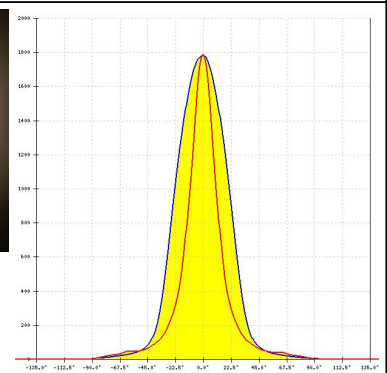
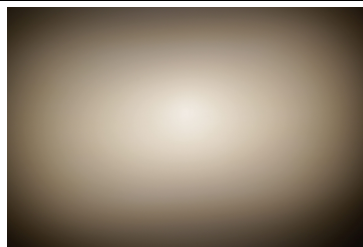

PHOTOMETRIC DATA (MEASURED):

XICATO

LED	XTM - 19mm LES
FWHM / FWTM	57.0 + 40.0° / 111.0 + 107.0°
Efficiency	82 %
Peak intensity	0.8 cd/lm
LEDs/each optic	1
Light colour	White
Required components:	
	C16058_XTM-ADAPTER-50-C

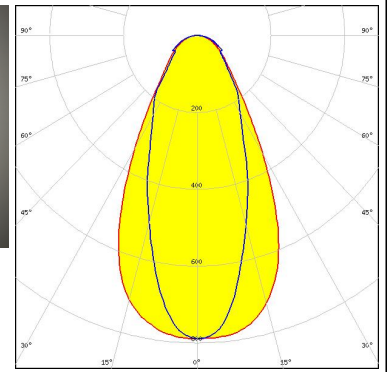

PHOTOMETRIC DATA (SIMULATED):

CITIZEN

LED CLL03x/CLU03x
 FWHM / FWTM 47.0 + 40.0° / 85.0 + 83.0°
 Efficiency 80 %
 Peak intensity 1.1 cd/lm
 LEDs/each optic 1
 Light colour White
 Required components:
 F15859_HEKLA-SOCKET-I

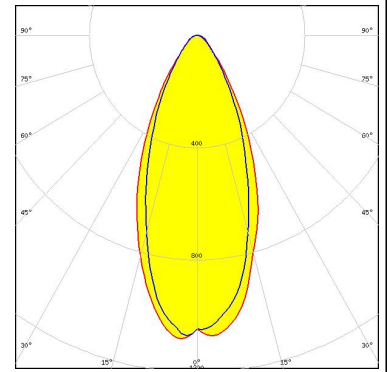

CITIZEN

LED CLU7B2
 FWHM / FWTM 48.0 + 12.0° / 68.0 + 27.0°
 Efficiency 91 %
 Peak intensity 3.3 cd/lm
 LEDs/each optic 1
 Light colour White
 Required components:
 F17435_HEKLA-G2-C

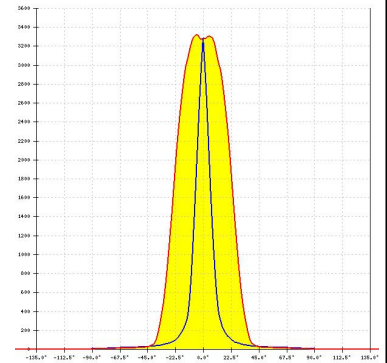
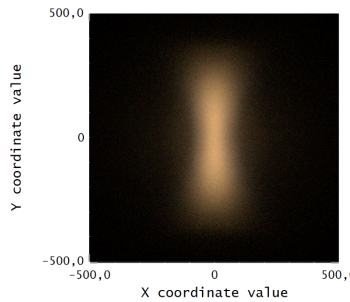

NICHIA

LED COB T-Type
 FWHM / FWTM 28.0 + 47.0° / 40.0 + 71.0°
 Efficiency 86 %
 Peak intensity 2.5 cd/lm
 LEDs/each optic 1
 Light colour White
 Required components:
 F15848_HEKLA-SOCKET-G

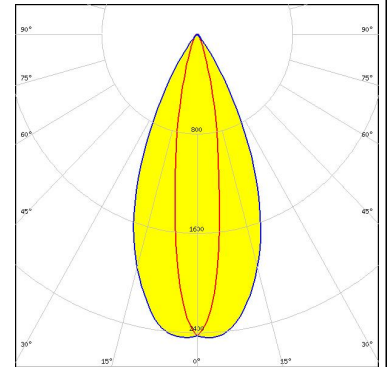

SAMSUNG

LED LC003D / LC006D / LC009D / LC013D
 FWHM / FWTM 44.0 + 27.0° / 71.0 + 61.0°
 Efficiency 87 %
 Peak intensity 1.8 cd/lm
 LEDs/each optic 1
 Light colour White
 Required components:
 F17435_HEKLA-G2-C

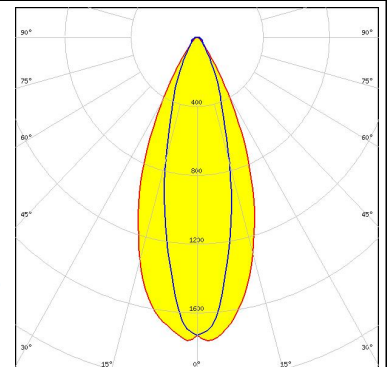
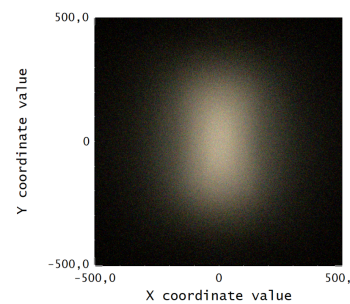

PHOTOMETRIC DATA (SIMULATED):

SAMSUNG

LED LC003D / LC006D / LC009D / LC013D
 FWHM / FWTM 46.0 + 18.0° / 70.0 + 40.0°
 Efficiency 90 %
 Peak intensity 2.6 cd/lm
 LEDs/each optic 1
 Light colour White
 Required components:
 F17435_HEKLA-G2-C

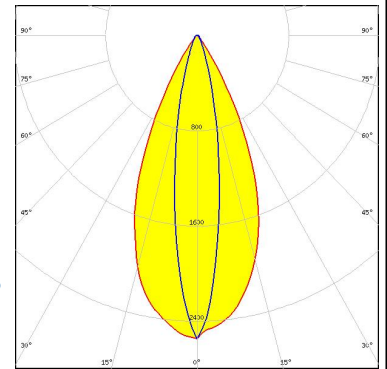
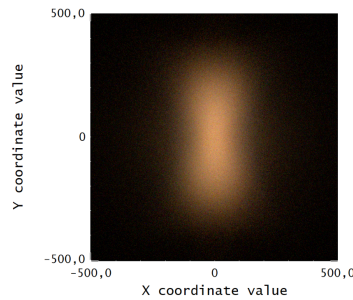

SAMSUNG

LED LC003D / LC006D / LC009D / LC013D
 FWHM / FWTM 44.0 + 26.0° / 71.0 + 58.0°
 Efficiency 88 %
 Peak intensity 1.9 cd/lm
 LEDs/each optic 1
 Light colour White
 Required components:
 F17435_HEKLA-G2-C

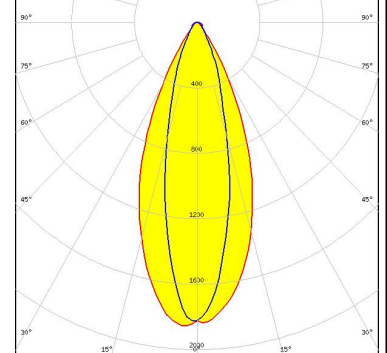
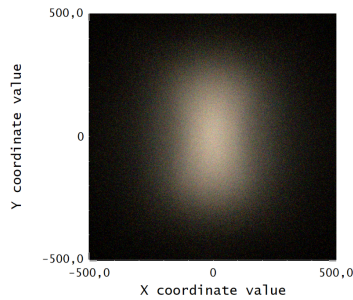

SAMSUNG

LED LC020C G2
 FWHM / FWTM 44.0 + 23.0° / 70.0 + 55.0°
 Efficiency 89 %
 Peak intensity 2 cd/lm
 LEDs/each optic 1
 Light colour White
 Required components:
 F17438_HEKLA-G2-I

