

Voltage Variable RF Attenuator

1MHz to 3000MHz

GENERAL DESCRIPTION

The F2255 is a low insertion loss **V**oltage **V**ariable RF **A**ttenuator (VVA) designed for a multitude of wireless and other RF applications. This device covers a broad frequency range from 1MHz to 3000MHz. In addition to providing low insertion loss, the F2255 provides excellent linearity performance over its entire voltage control and attenuation range.

The F2255 uses a single positive supply voltage of 3.15V to 5.25V. Other features include the V_{MODE} pin allowing either positive or negative voltage control slope vs attenuation and multi-directional operation meaning the RF input can be applied to either RF1 or RF2 pins. Control voltage ranges from 0V to 3.6V using either positive or negative control voltage slope.

COMPETITIVE ADVANTAGE

The F2255 provides extremely low insertion loss and superb IP3, IP2, Return Loss and Slope Linearity across the control range. Comparing to competitive VVAs this device is better as follows:

- ✓ Operation down to 1MHz
- ✓ Insertion Loss @ 500MHz: 1.1dB
- ✓ Maximum Attenuation Slope: 33dB/Volt
- ✓ Minimum Output IP3: 35dBm
- ✓ Minimum Input IP2: 74dBm
- ✓ High Operating Temperature: +105°C

APPLICATIONS

- Base Station 2G, 3G, 4G
- Portable Wireless
- Repeaters and E911 systems
- Digital Pre-Distortion
- Point to Point Infrastructure
- Public Safety Infrastructure
- Satellite Receivers and Modems
- WIMAX Receivers and Transmitters
- Military Radios covering HF, VHF, UHF
- RFID handheld and portable readers
- Cable Infrastructure
- Wireless LAN
- Test / ATE Equipment

FEATURES

- Low Insertion Loss: 1.1dB @ 500MHz
- Typical / Min IIP3: 60dBm / 46dBm
- Typical / Min IIP2: 98dBm / 74dBm
- 33dB Attenuation Range
- Bi-directional RF ports
- +36dBm Input P1dB compression
- V_{MODE} pin allows either positive or negative control response
- Linear-in-dB attenuation characteristic
- Supply voltage: 3.15V to 5.25V
- V_{CTRL} range: 0V to 3.6V using 5V supply
- +105°C max operating temperature
- 3mm x 3mm, 16-pin QFN package

DEVICE BLOCK DIAGRAM

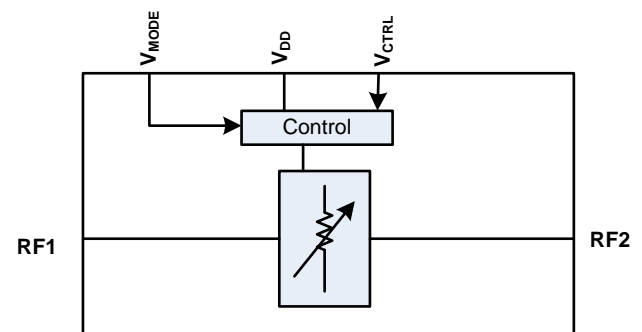

ORDERING INFORMATION



PART# MATRIX

| Part# | RF Freq Range (MHz) | Insertion Loss (dB) | IIP3 (dBm) | Pinout Compatibility |
|-------|---------------------|---------------------|------------|----------------------|
| F2250 | 50 - 6000 | 1.4 (at 2GHz) | +65 | RFMD |
| F2255 | 1 - 3000 | 1.1 (at 500MHz) | +60 | |
| F2258 | 50 - 6000 | 1.4 (at 2GHz) | +65 | Hittite |

Voltage Variable RF Attenuator

1MHz to 3000MHz

ABSOLUTE MAXIMUM RATINGS

| Parameter / Condition | Symbol | Min | Max | Units |
|--|---------------------|------|-----------------------------------|-------|
| V _{DD} to GND | V _{DD} | -0.3 | 5.5 | V |
| V _{MODE} to GND | V _{MODE} | -0.3 | Minimum (V _{DD} , 3.9) | V |
| V _{CTRL} to GND | V _{CTRL} | -0.3 | Minimum (V _{DD} , 4.0) | V |
| RF1, RF2 to GND | V _{RF} | -0.3 | 0.3 | V |
| RF1 or RF2 Input Power applied for 24 hours maximum (V _{DD} applied @ 2GHz and T _c =+85°C) | P _{MAX24} | | 30 | dBm |
| RF1 or RF2 Continuous Operating Power | P _{MAX_OP} | | See Figure 1 | dBm |
| Maximum Junction Temperature | T _{JMAX} | | +150 | °C |
| Storage Temperature Range | T _{ST} | -65 | +150 | °C |
| Lead Temperature (soldering, 10s) | T _{LEAD} | | +260 | °C |
| ESD Voltage– HBM (Per ESD STM5.1-2007) | V _{ESDHBM} | | Class 2 | |
| ESD Voltage – CDM (Per ESD STM5.3.1-2009) | V _{ESDCDM} | | Class C3 | |

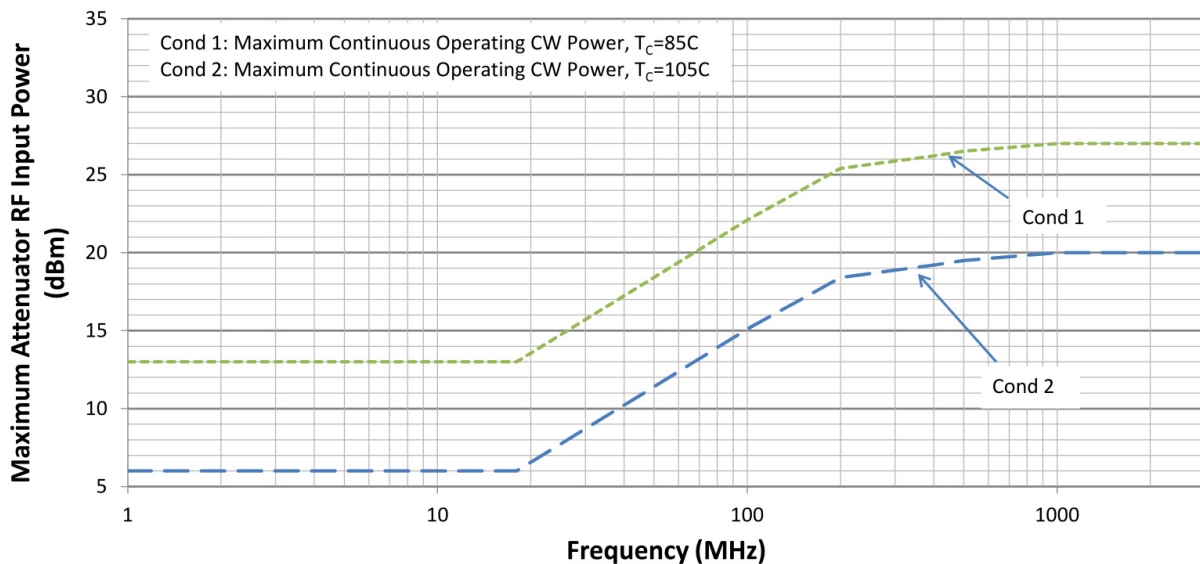

FIGURE 1: MAXIMUM OPERATING RF INPUT POWERS VS. RF FREQUENCY

Stresses above those listed above may cause permanent damage to the device. Functional operation of the device at these or any other conditions above those indicated in the operational section of this specification is not implied. Exposure to absolute maximum rating conditions for extended periods may affect device reliability.

PACKAGE THERMAL AND MOISTURE CHARACTERISTICS

| | |
|---|----------|
| θ _{JA} (Junction – Ambient) | 80.6°C/W |
| θ _{Jc} (Junction – Case) The Case is defined as the exposed paddle | 5.1°C/W |
| Moisture Sensitivity Rating (Per J-STD-020) | MSL 1 |

Voltage Variable RF Attenuator
1MHz to 3000MHz
F2255 OPERATING CONDITIONS

| Parameter | Symbol | Condition | Min | Typ | Max | Units |
|---------------------------------|-------------|----------------------------|--------------------------|------|------------------|-------------|
| Operating Frequency Range | F_{RF} | | 1 | | 3000 | MHz |
| Supply Voltage | V_{DD} | | 3.15 | | 5.25 | V |
| V_{MODE} Logic | V_{IH} | $V_{DD} > 3.9V$ | 1.17 | | 3.6 ² | V |
| | | $V_{DD} = 3.15$ to 3.9V | 1.17 | | $V_{DD} - 0.3V$ | |
| | V_{IL} | | 0 | | 0.63 | |
| V_{CTRL} Range | V_{CTRL} | $V_{DD} = 3.9V$ to 5.25V | 0 | | 3.6 | V |
| | | $V_{DD} = 3.15V$ to 3.9V | 0 | | $V_{DD} - 0.3$ | |
| Supply Current | I_{DD} | | 0.50 ¹ | 1.15 | 2 | mA |
| Logic Current | I_{MODE} | | -1.0 | | 38 | μA |
| I_{CTRL} Current | I_{CTRL} | | -1.0 | | 14 | μA |
| RF Operating Power ³ | P_{MAXCW} | | | | See Figure 1 | dBm |
| RF1 Port Impedance | Z_{RF1} | | | 50 | | Ω |
| RF2 Port Impedance | Z_{RF2} | | | 50 | | |
| Operating Temperature Range | T_{CASE} | Exposed Paddle Temperature | -40 | | +105 | $^{\circ}C$ |

Operating Conditions Notes:

- 1 – Items in min/max columns in ***bold italics*** are Guaranteed by Test.
- 2 – Items in min/max columns that are not bold/italics are Guaranteed by Design Characterization.
- 3 – Refer to the Maximum **Operating** RF Input Power vs. RF Frequency curves in Figure 1.

Voltage Variable RF Attenuator
1MHz to 3000MHz
F2255 SPECIFICATIONS

Refer to EVKit / Applications Circuit, $V_{DD} = +3.3V$, $T_C = +25^\circ C$, signals applied to RF1 input, $F_{RF} = 500MHz$, minimum attenuation, $P_{IN} = 0dBm$ for small signal parameters, $+20dBm$ for single tone linearity tests, $+20dBm$ per tone for two tone tests, two tone delta frequency = $80MHz$, PCB board traces and connector losses are de-embedded unless otherwise noted. Refer to Typical Operating Curves for performance over entire frequency band.

| Parameter | Symbol | Condition | Min | Typ | Max | Units |
|--|-----------------------|---|-----------------|------|--------------------------------|-----------|
| Insertion Loss, IL | A_{MIN} | Minimum Attenuation | | 1.1 | <i>1.7</i> ¹ | dB |
| Maximum attenuation | A_{MAX} | | 33 | 34.6 | | dB |
| Insertion Phase Δ | $\Phi_{\Delta MAX}$ | At 36dB attenuation relative to Insertion Loss | | 27 | | deg |
| | $\Phi_{\Delta MID}$ | At 18dB attenuation relative to Insertion Loss | | 8 | | |
| Input 1dB Compression ³ | P1dB | | | 36 | | dBm |
| Minimum RF1 Return Loss over control voltage range | S11 | 20MHz | | 23 | | dB |
| | | 500MHz | | 22 | | |
| | | 2000MHz | | 23 | | |
| | | 3000MHz | | 30 | | |
| Minimum RF2 Return Loss over control voltage range | S22 | 20MHz | | 23 | | dB |
| | | 500MHz | | 22 | | |
| | | 2000MHz | | 23 | | |
| | | 3000MHz | | 24 | | |
| Input IP3 | IIP3 | | | 60 | | dBm |
| Input IP3 over Attenuation | IIP3 _{ATTEN} | All attenuation settings | 44 ² | 46 | | |
| Minimum Output IP3 | OIP3 _{MIN} | Maximum attenuation | | 35 | | |
| Input IP2 | IIP2 | $P_{IN} + IM2_{dBc}$, IM2 term is $F1 + F2$ | | 98 | | dBm |
| Minimum Input IP2 | IIP2 _{MIN} | All attenuation settings | | 74 | | dBm |
| Input IH2 | HD2 | $P_{IN} + H2_{dBc}$ | | 82 | | dBm |
| Input IH3 | HD3 | $P_{IN} + (H3_{dBc}/2)$ | | 49 | | dBm |
| Settling Time | $T_{SETTL0.1dB}$ | Any 1dB step in the 0dB to 33dB control range 50% V_{CTRL} to RF settled to within $\pm 0.1dB$ | | 15 | | μSec |

Specification Notes:

- 1 – Items in min/max columns in ***bold italics*** are Guaranteed by Test.
- 2 – Items in min/max columns that are not bold/italics are Guaranteed by Design Characterization.
- 3 – The input 1dB compression point is a linearity figure of merit. Refer to Absolute Maximum Ratings section along with Figure 1 for the maximum RF input power vs. RF frequency.

Voltage Variable RF Attenuator**1MHz to 3000MHz****TYPICAL OPERATING CURVES****UNLESS OTHERWISE NOTED, THE FOLLOWING CONDITIONS APPLY:**

- $V_{DD} = +3.3V$ or $+5.0V$
- $T_C = +25^{\circ}C$
- $V_{MODE} = 0V$
- RF trace and connector losses are de-embedded for S-parameters
- $P_{in} = 0dBm$ for all small signal tests
- $P_{in} = +20dBm$ for single tone linearity tests (RF1 port driven)
- $P_{in} = +20dBm/tone$ for two tone linearity tests (RF1 port driven)
- Two tone frequency spacing = 80MHz

Voltage Variable RF Attenuator

1MHz to 3000MHz

TYPICAL OPERATING CONDITIONS [S2P BROADBAND PERFORMANCE] (-1-)

Attenuation vs. V_{CTRL}

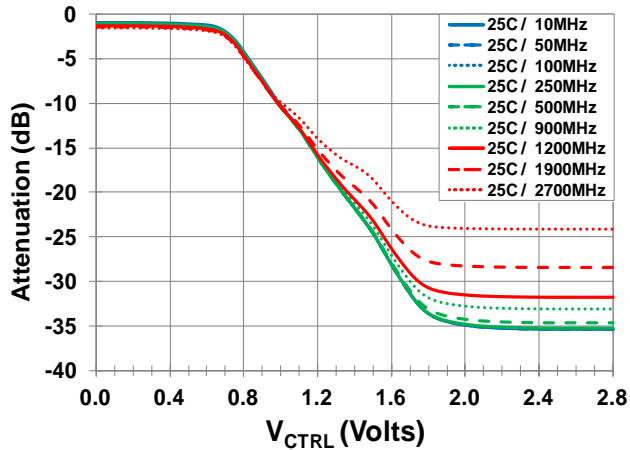

Attenuation vs. Frequency

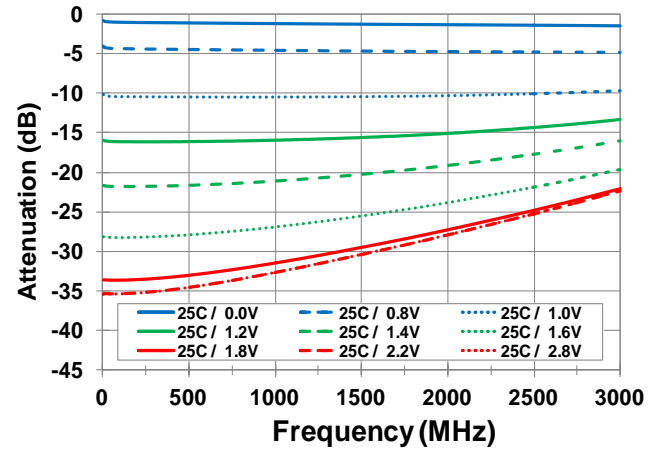

Attenuation Delta to 25C vs. V_{CTRL}

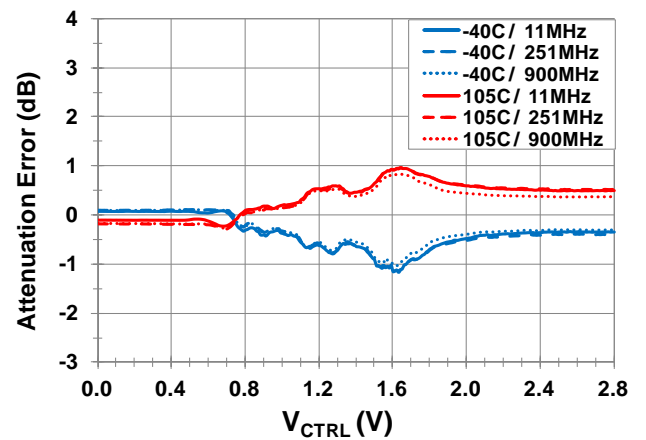

Voltage Variable RF Attenuator

1MHz to 3000MHz

TYPICAL OPERATING CURVES [S2P vs. V_{CTRL}] (-2-)

Attenuation vs. V_{CTRL}

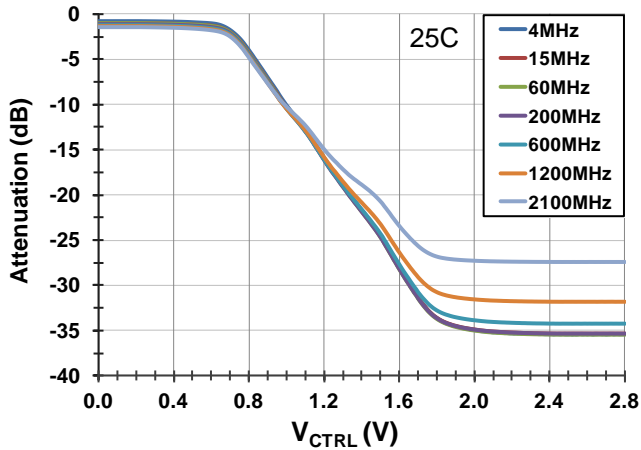

Attenuation Slope vs. V_{CTRL}

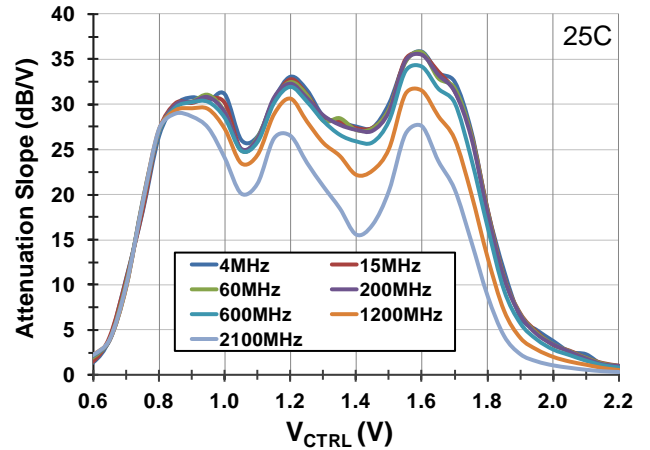

RF1 Return Loss vs. V_{CTRL}

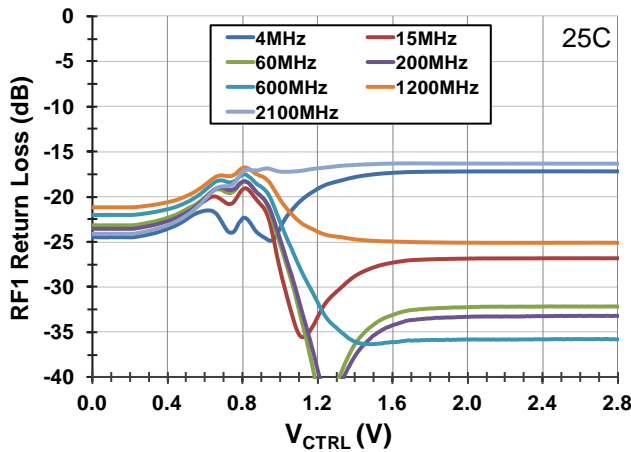

RF2 Return Loss vs. V_{CTRL}

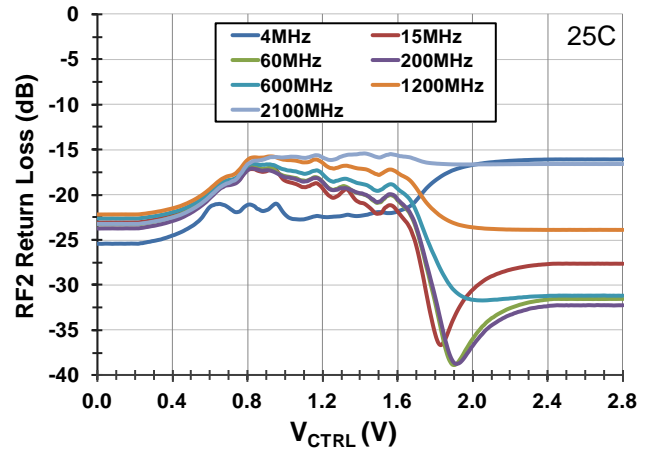

Insertion Phase Δ vs. V_{CTRL}

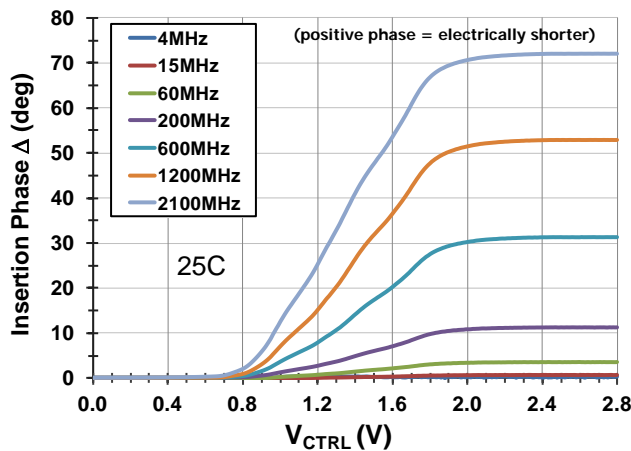

Insertion Phase Slope vs. V_{CTRL}

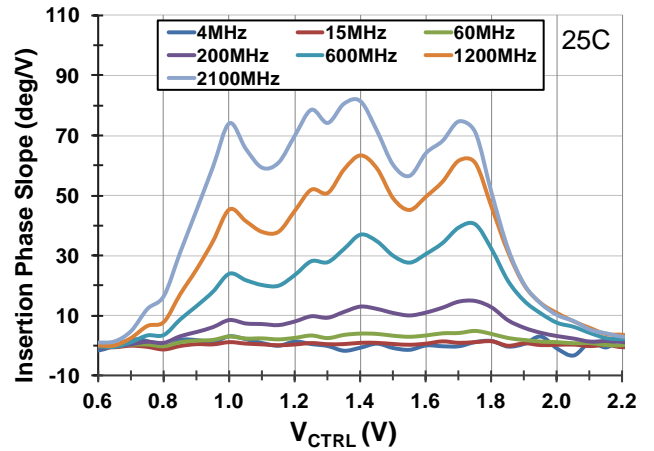

Voltage Variable RF Attenuator

1MHz to 3000MHz

TYPICAL OPERATING CONDITIONS [S2P vs. V_{CTRL} & TEMPERATURE] (-3-)

Attenuation Response vs. V_{CTRL}

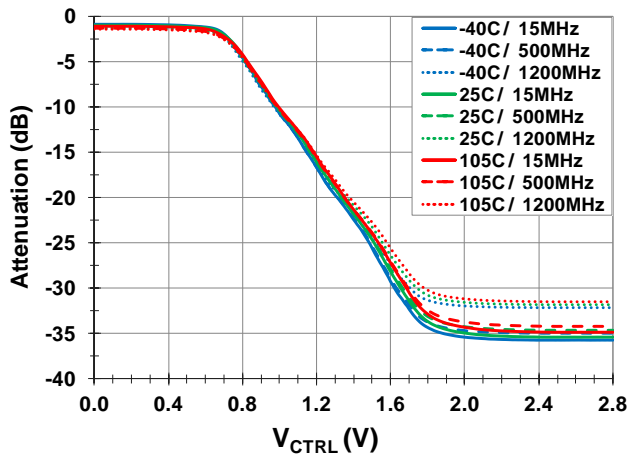

Attenuation Slope vs. V_{CTRL}

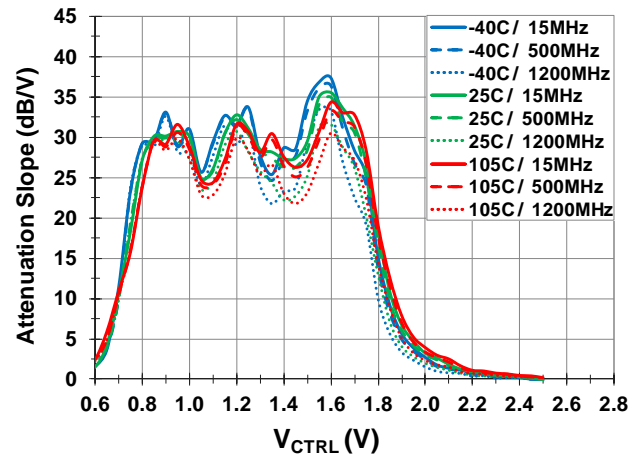

RF1 Return Loss vs. V_{CTRL}

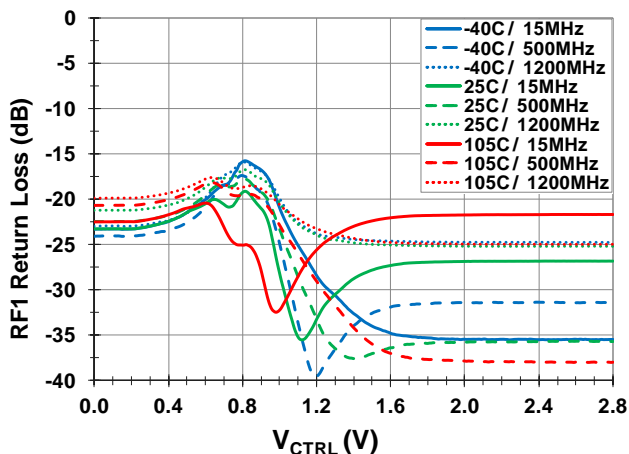

RF2 Return Loss vs. V_{CTRL}

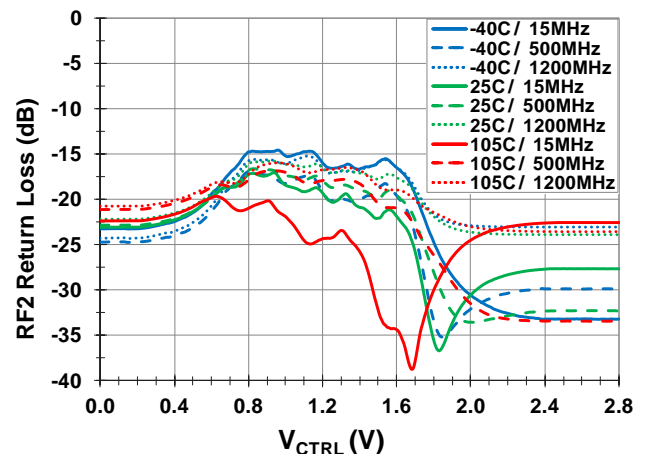

Insertion Phase Δ vs. V_{CTRL}

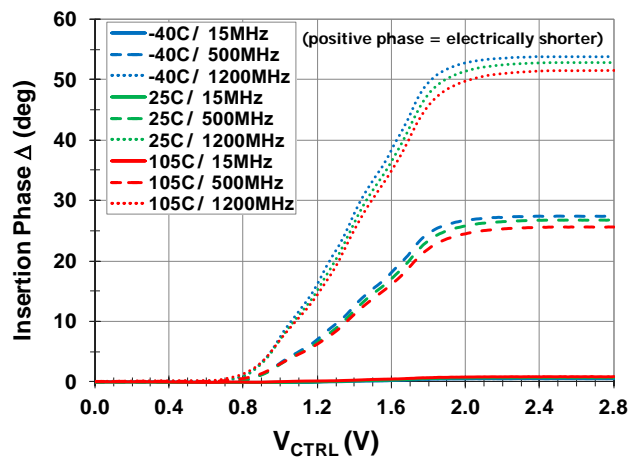

Insertion Phase Slope vs. V_{CTRL}

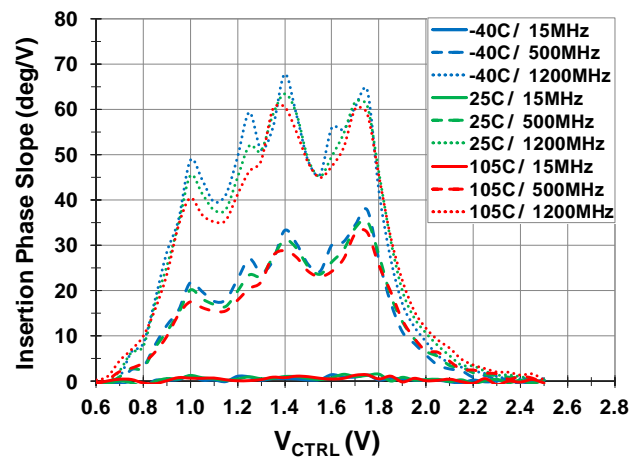

Voltage Variable RF Attenuator

1MHz to 3000MHz

TYPICAL OPERATING CONDITIONS [S2P vs. ATTENUATION & TEMPERATURE] (-4-)

RF1 Return Loss vs. Attenuation

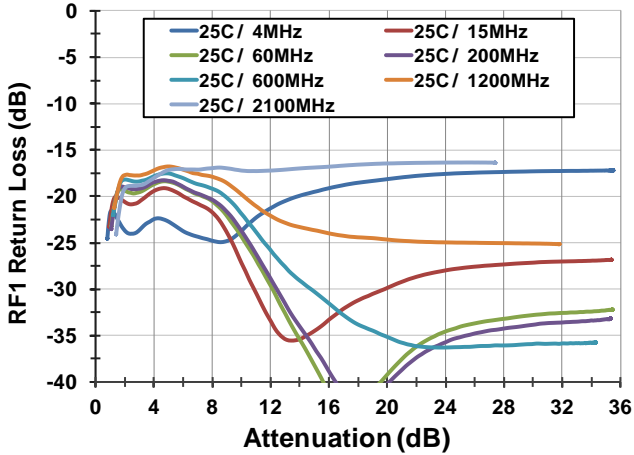

RF1 Return Loss vs. Attenuation

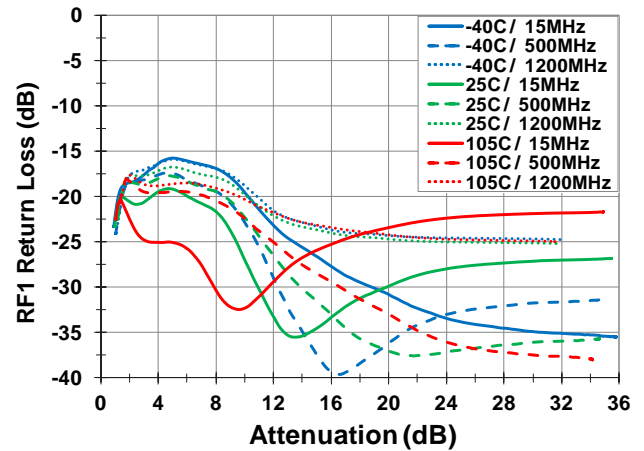

RF2 Return Loss vs. Attenuation

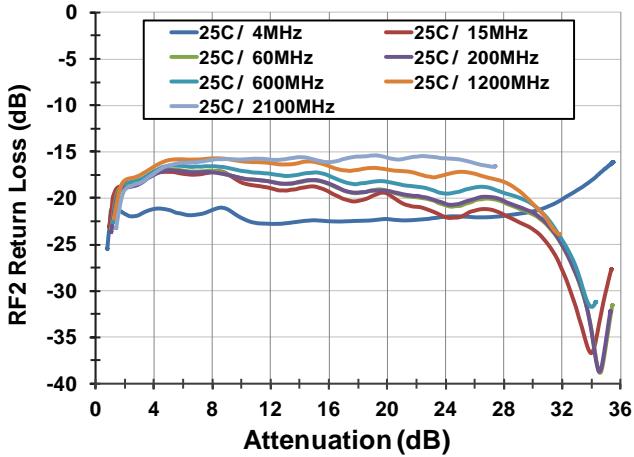

RF2 Return Loss vs. Attenuation

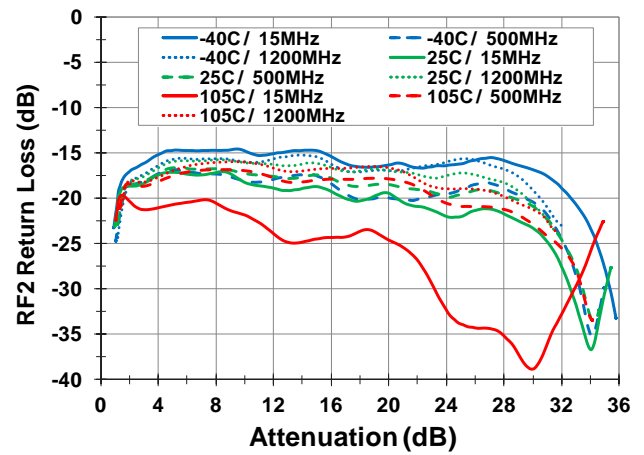

Insertion Phase Δ vs. Attenuation

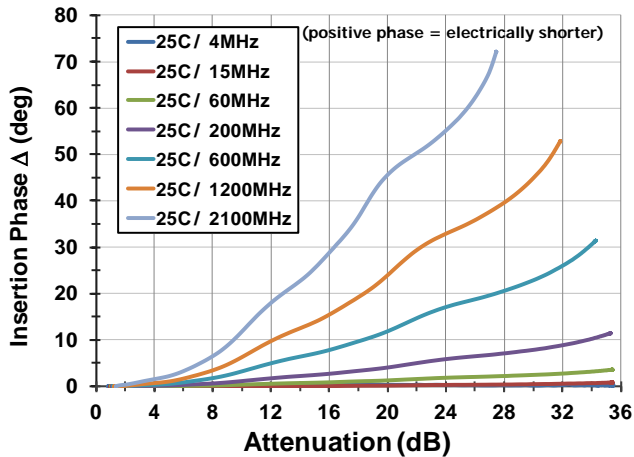

Insertion Phase Δ vs. Attenuation

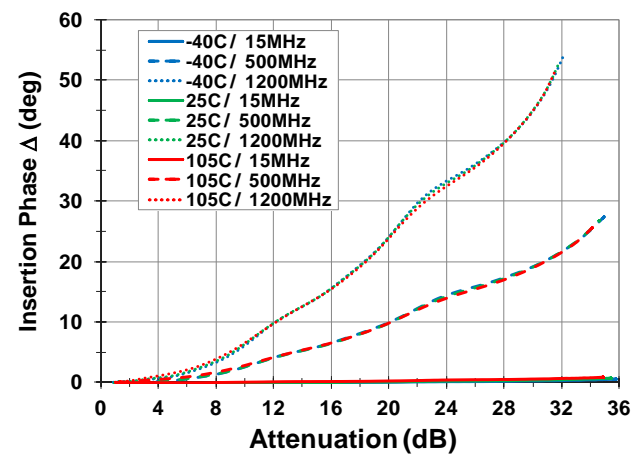

Voltage Variable RF Attenuator

1MHz to 3000MHz

TYPICAL OPERATING CONDITIONS [S2P vs. FREQUENCY] (-5-)

Min. & Max. Attenuation vs. Frequency

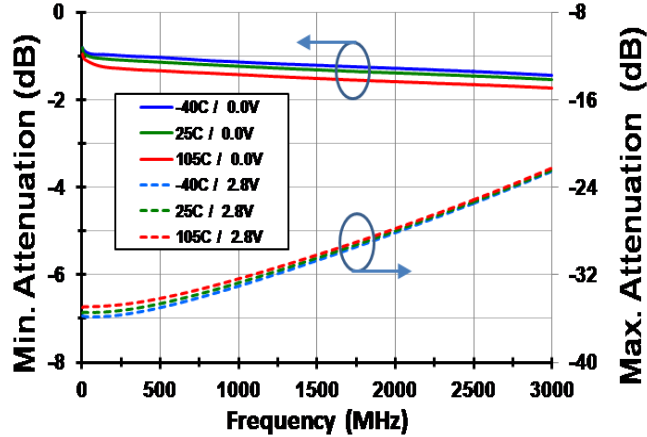

Min. & Max. Attenuation Slope vs. Frequency

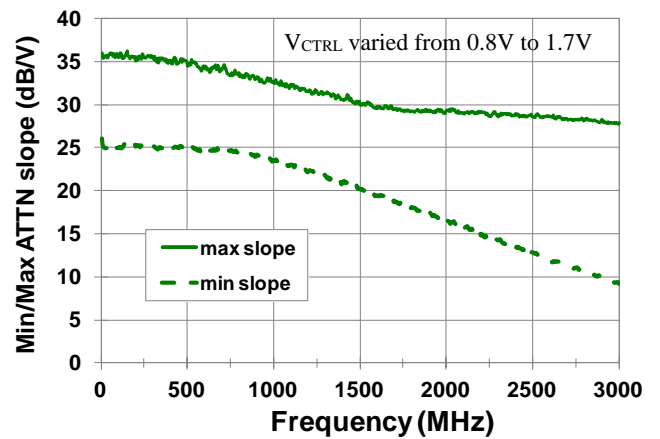

Worst-Case RF1 Return Loss vs. Frequency

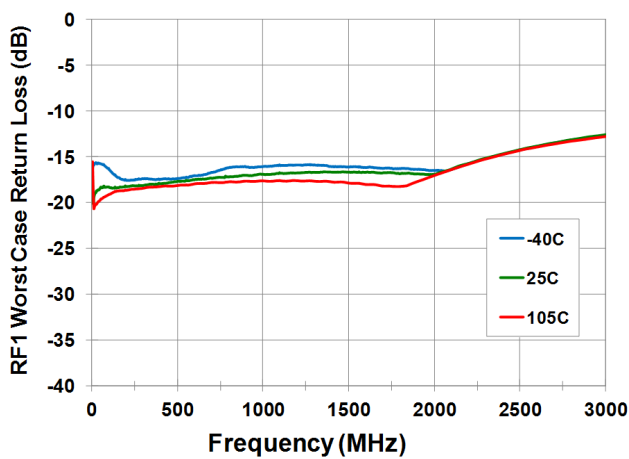

Worst-Case RF2 Return Loss vs. Frequency

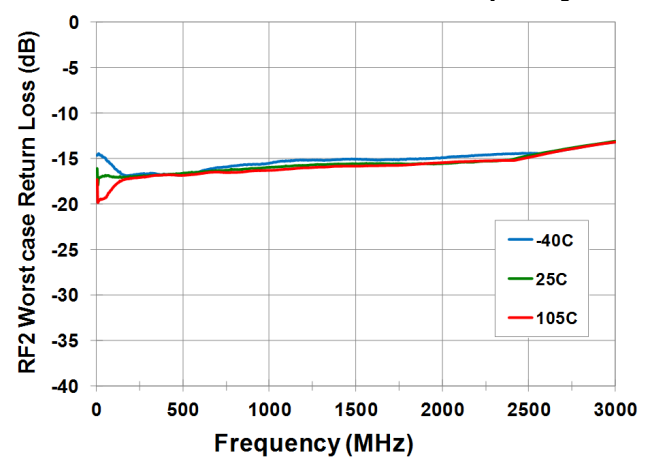

Max. Insertion Phase Δ vs. Frequency

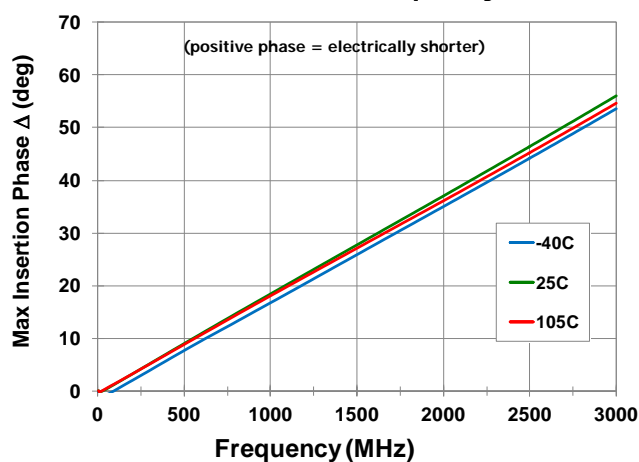

Gain Compression vs. Frequency

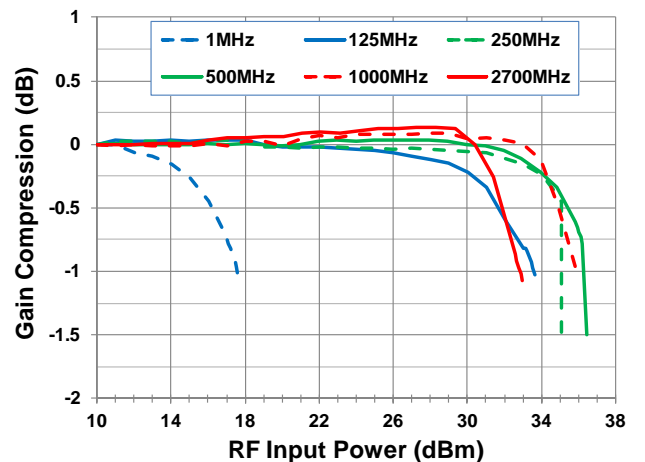

Voltage Variable RF Attenuator

1MHz to 3000MHz

TYPICAL OPERATING CONDITIONS [S2P @ LOW FREQUENCY, GROUP DELAY] (-6-)

Min. & Max. Attenuation vs. Low Frequency

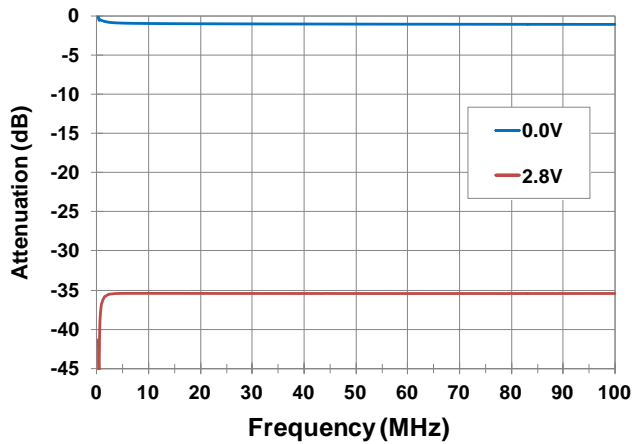

Low-Frequency Attenuation vs. V_{CTRL}

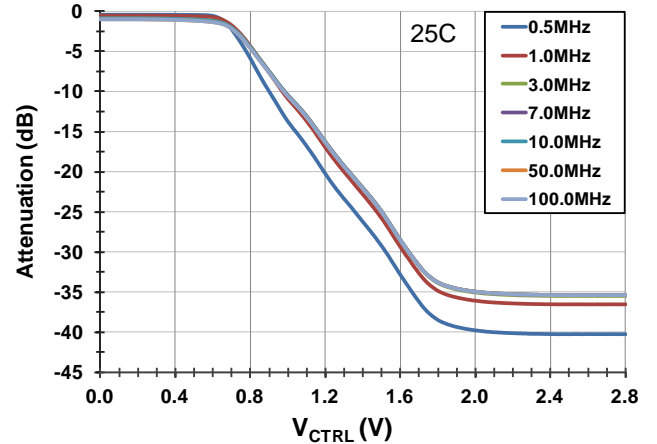

Low-Frequency RF1 Return Loss vs. V_{CTRL}

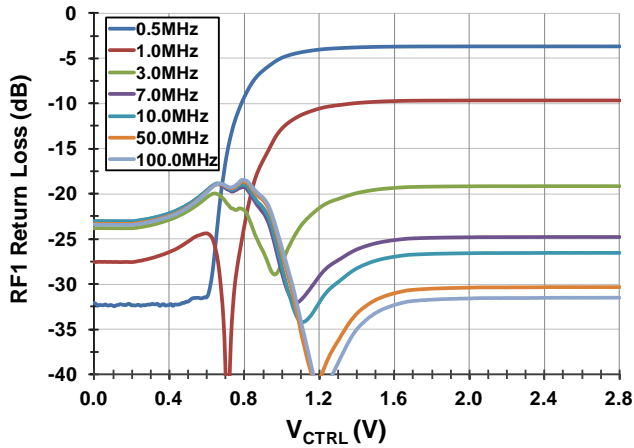

Low-Frequency RF2 Return Loss vs. V_{CTRL}

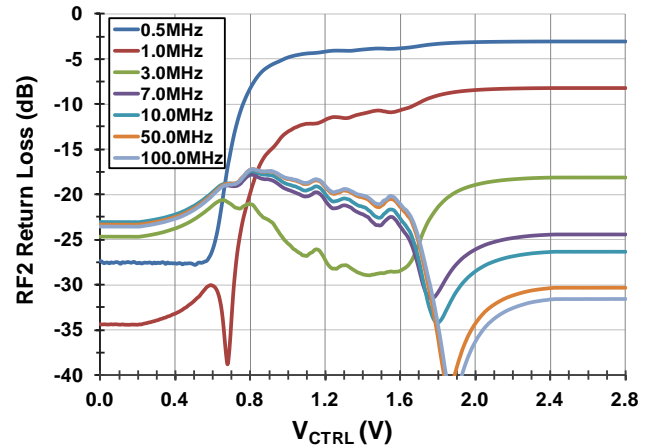

Group Delay vs. Frequency

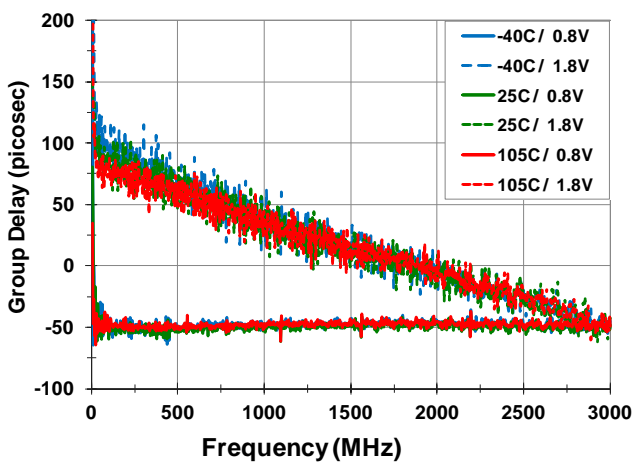

Voltage Variable RF Attenuator

1MHz to 3000MHz

TYPICAL OPERATING CONDITIONS 500MHz, $V_{DD}=3.3V$ [IP3, IP2, IH2, IH3 vs. V_{CTRL} , V_{MODE}] (-7-)

Input IP3 vs. V_{CTRL}

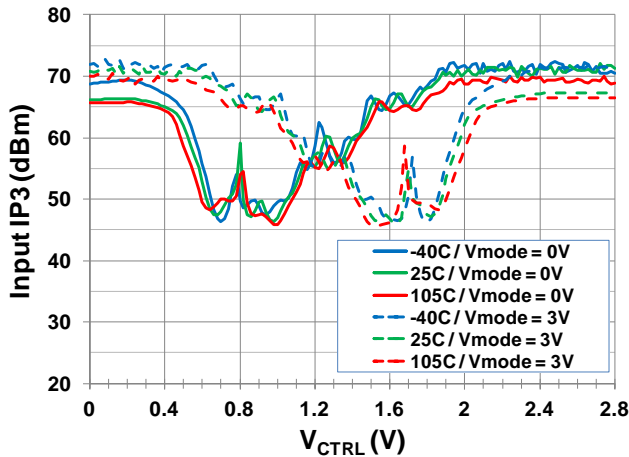

Output IP3 vs. V_{CTRL}

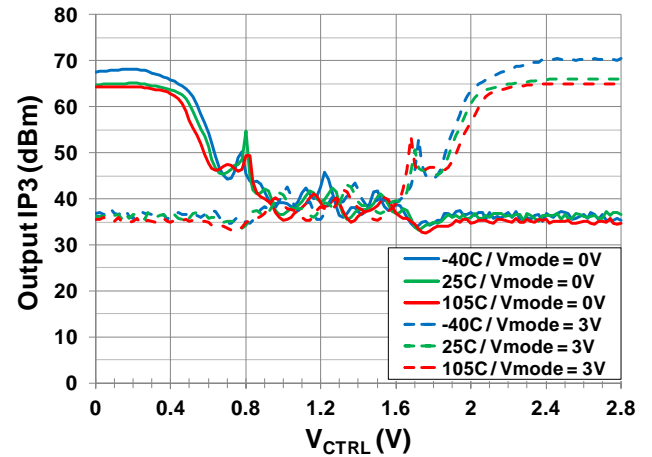

Input IP2 vs. V_{CTRL}

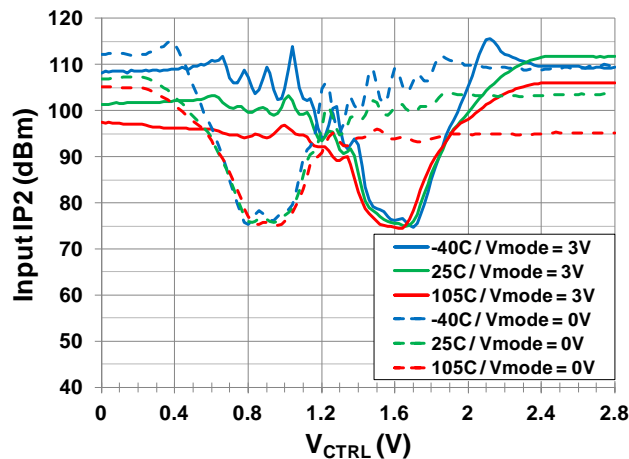

Output IP2 vs. V_{CTRL}

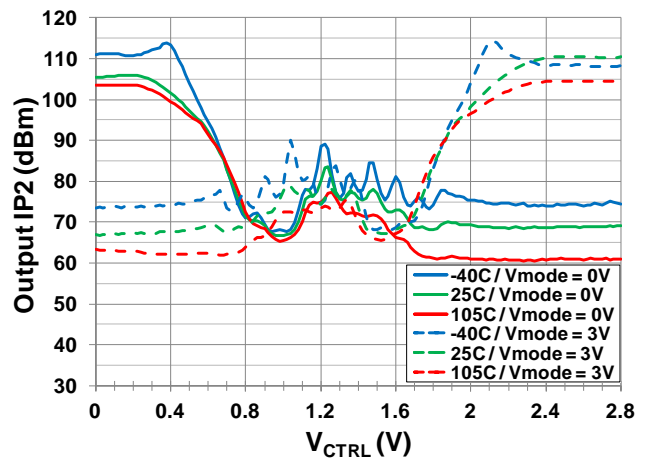

2nd Harm Input Intercept Point vs. V_{CTRL}

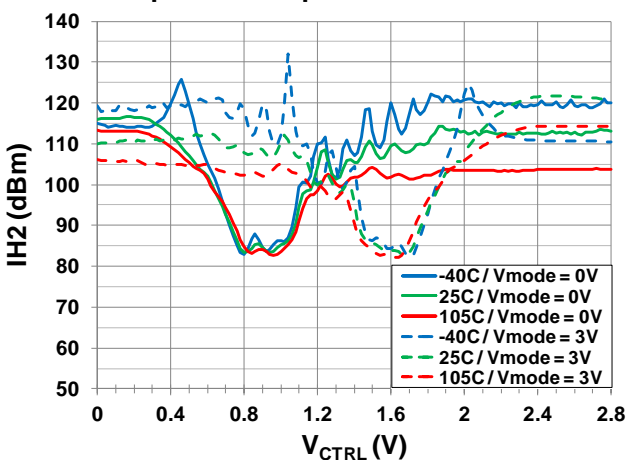

3rd Harm Input Intercept Point vs. V_{CTRL}

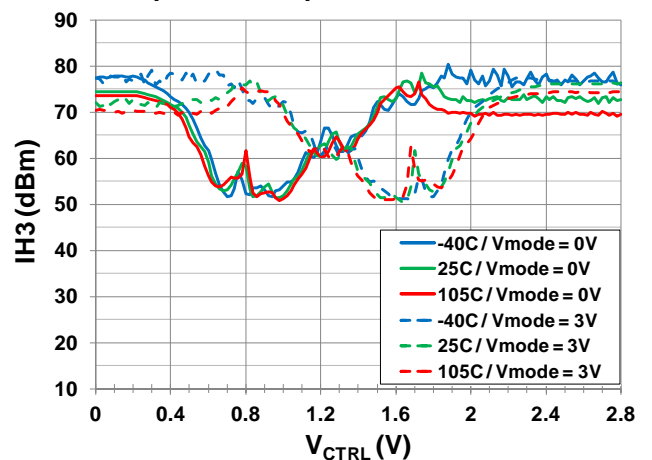

Voltage Variable RF Attenuator

1MHz to 3000MHz

TYPICAL OPERATING CONDITIONS 500MHz, $V_{DD}=3.3V$ [IPX, IHX vs. V_{CTRL} , RF1/RF2 DRIVEN] (-8-)

Input IP3 vs. V_{CTRL}

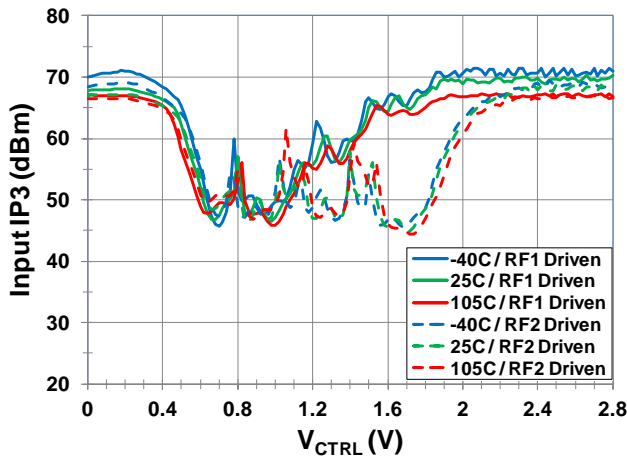

Output IP3 vs. V_{CTRL}

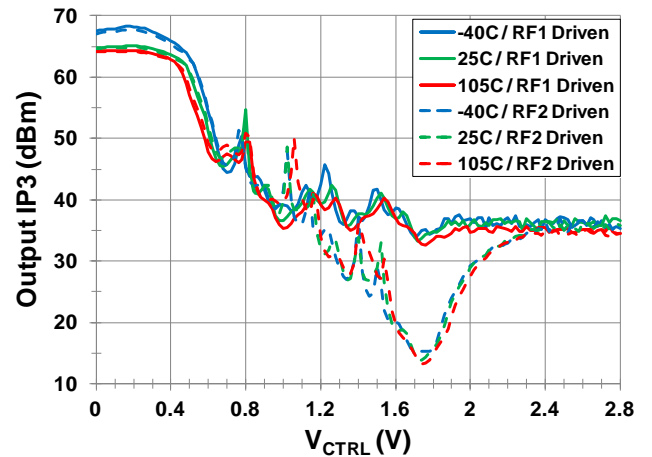

Input IP2 vs. V_{CTRL}

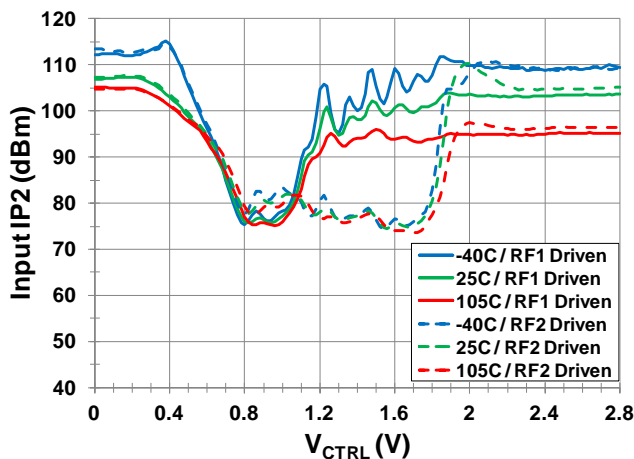

Output IP2 vs. V_{CTRL}

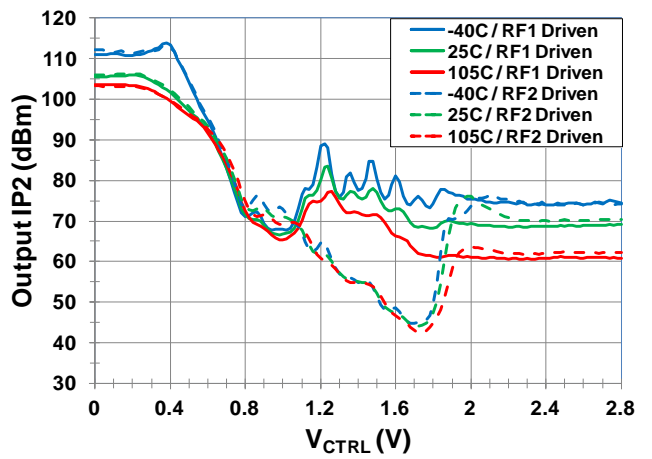

2nd Harm Input Intercept Point vs. V_{CTRL}

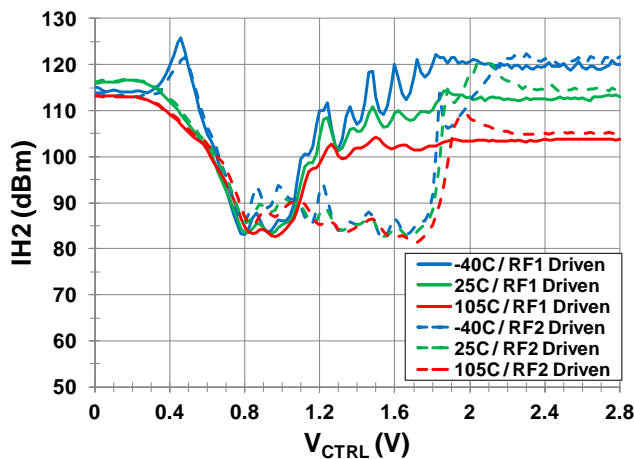

3rd Harm Input Intercept Point vs. V_{CTRL}

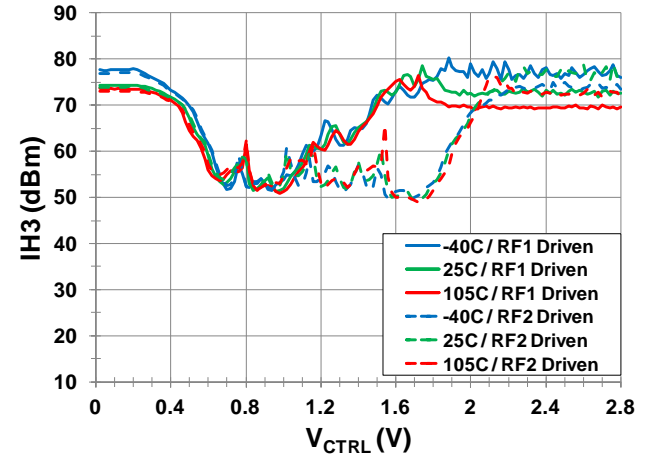

Voltage Variable RF Attenuator

1MHz to 3000MHz

TYPICAL OPERATING CONDITIONS 500MHz, $V_{DD}=3.3V$ [IP3, IP2, IH2, IH3 vs. ATTENUATION] (-9-)

Input IP3 vs. Attenuation

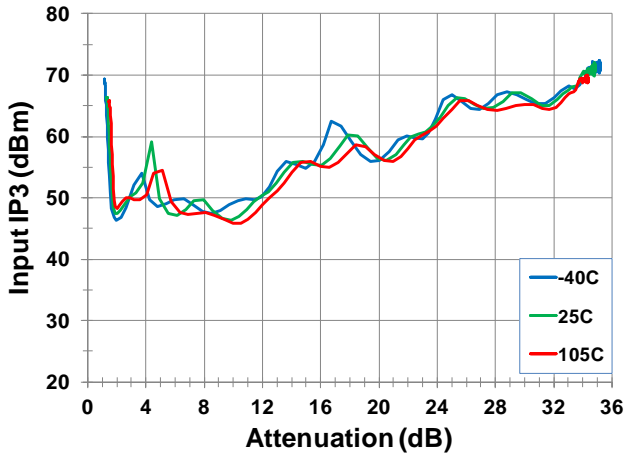

Output IP3 vs. Attenuation

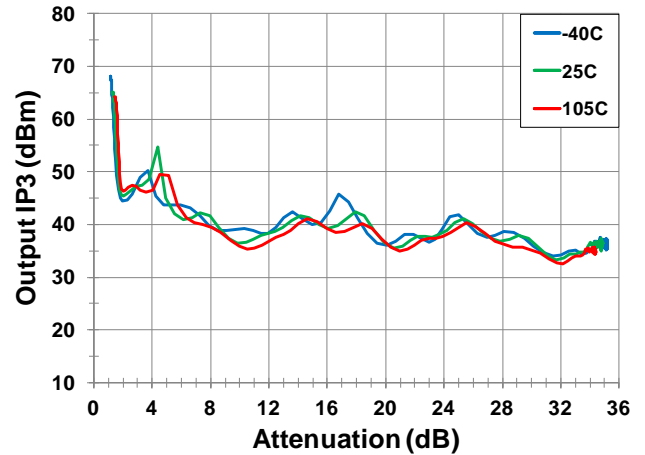

Input IP2 vs. Attenuation

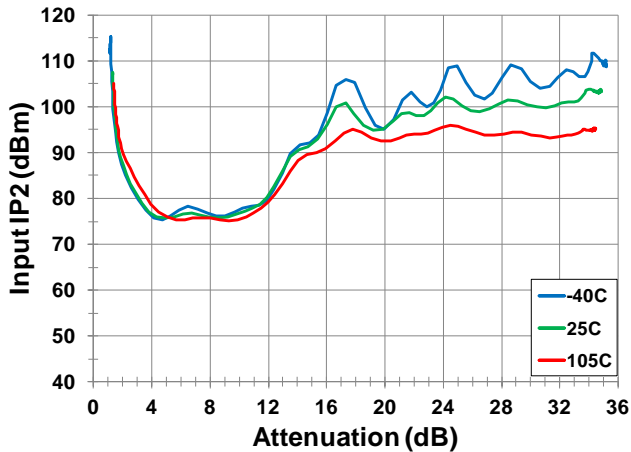

Output IP2 vs. Attenuation

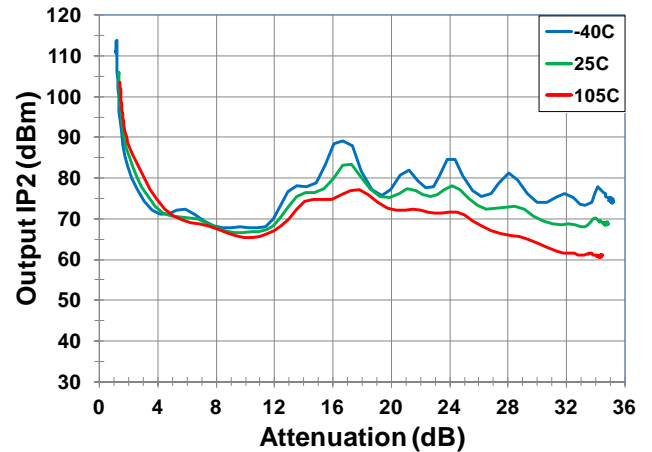

2nd Harm Input Intercept Point vs. Attenuation

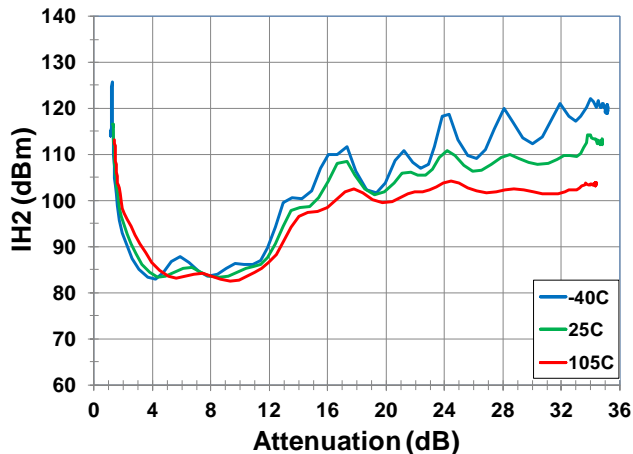

3rd Harm Input Intercept Point vs. Attenuation

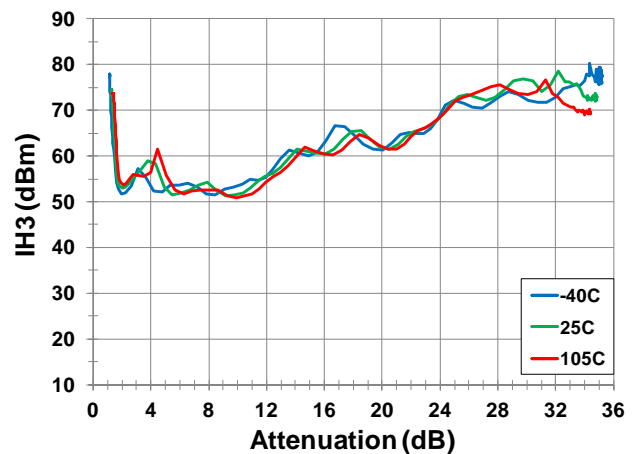

Voltage Variable RF Attenuator

1MHz to 3000MHz

TYPICAL OPERATING CONDITIONS 500MHz, $V_{DD}=3.3V$ [IP_X, IH_X vs. ATTEN, RF1/RF2 DRIVEN] (-10-)

Input IP3 vs. Attenuation

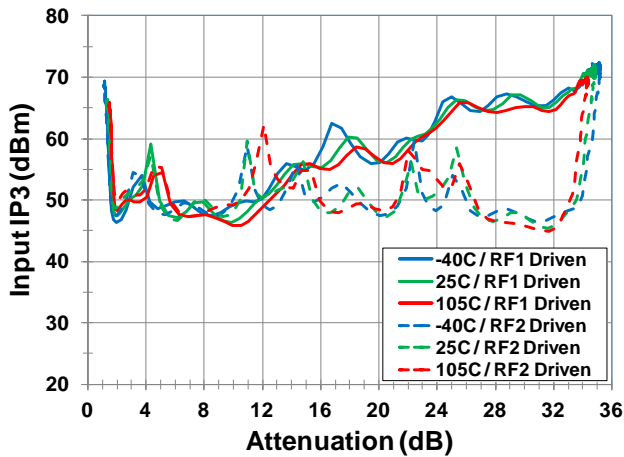

Output IP3 vs. Attenuation

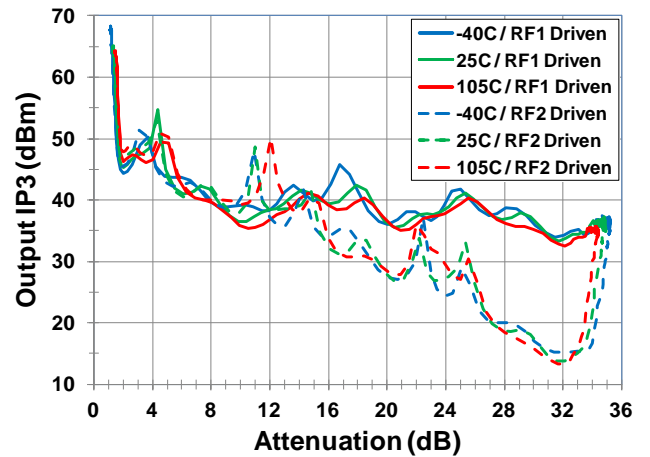

Input IP2 vs. Attenuation

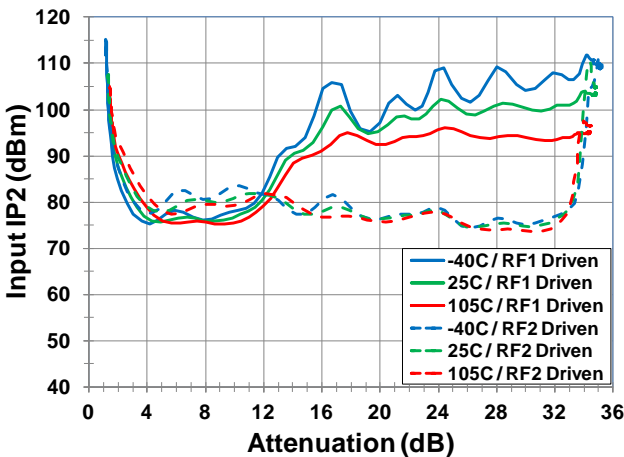

Output IP2 vs. Attenuation

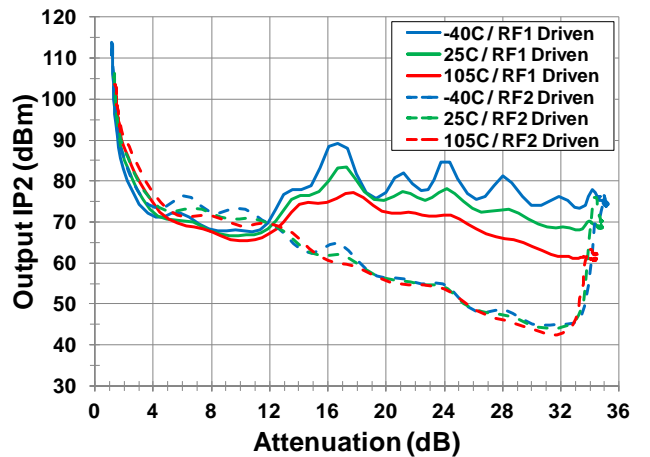

2nd Harm Input Intercept Point vs. Attenuation

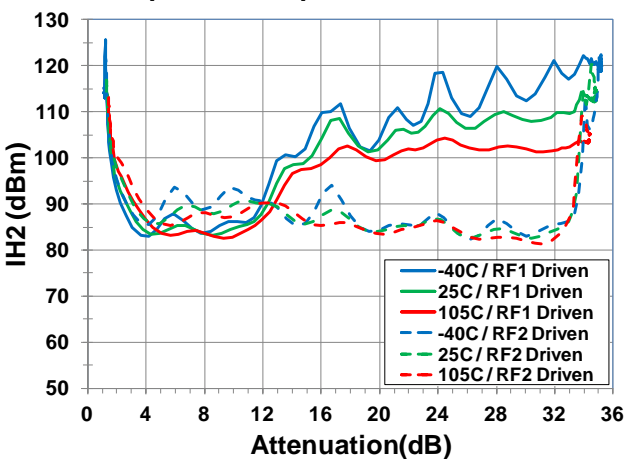

3rd Harm Input Intercept Point vs. Attenuation

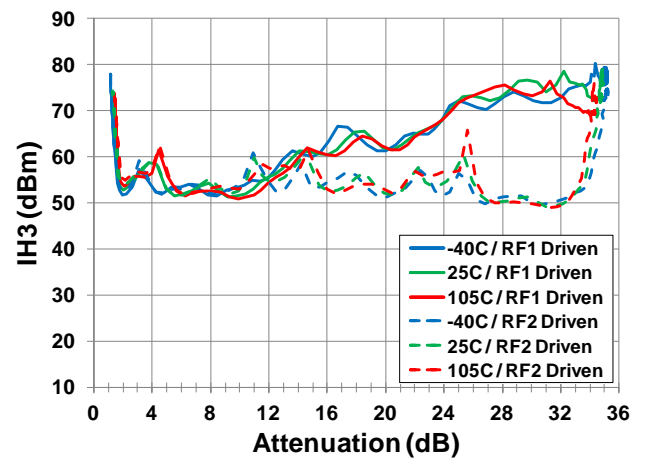

Voltage Variable RF Attenuator

1MHz to 3000MHz

PACKAGE OUTLINE DRAWING

The package outline drawings are located at the end of this document and are accessible from the Renesas website (see also [16-VFQFPN](#)). The package information is the most current data available and is subject to change without revision of this document.

PINOUT & BLOCK DIAGRAM

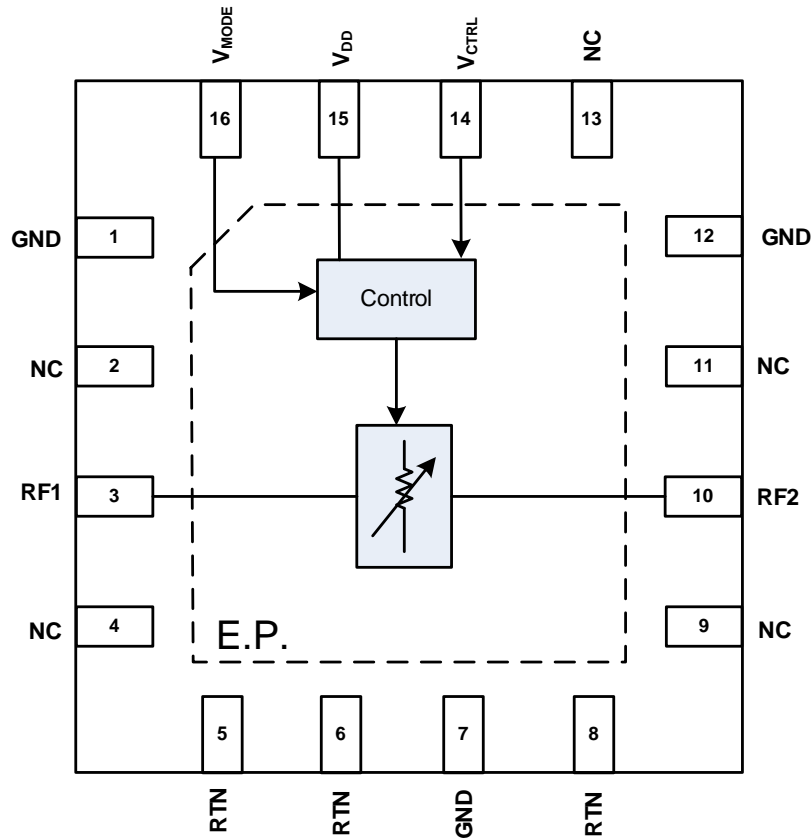

Voltage Variable RF Attenuator
1MHz to 3000MHz
PIN DESCRIPTION

| Pin | Name | Function |
|-----------------|-------------------|---|
| 1, 7, 12 | GND | Ground these pins as close to the device as possible. |
| 2, 4, 9, 11, 13 | NC | No internal connection. Renesas recommends connecting these pins to GND. |
| 3 | RF1 | RF Port 1. Matched to 50 ohms. Must use an external AC coupling capacitor as close to the device as possible. For low frequency operation increase the capacitor value to result in a low reactance at the frequency of interest. |
| 5, 6, 8 | RTN | Attenuator Ground Return. Each of these pins require a capacitor to GND to provide an RF return path. Place the capacitor as close to the device as possible. |
| 10 | RF2 | RF Port 2. Matched to 50 ohms. Must use an external AC coupling capacitor as close to the device as possible. For low frequency operation increase the capacitor value to result in a low reactance at the frequency of interest. |
| 14 | V _{CTRL} | Attenuator control voltage. Apply a voltage in the range as specified in the Operating Conditions Table. See application section for details about V _{CTRL} . |
| 15 | V _{DD} | Power supply input. Bypass to GND with capacitors close as possible to pin. |
| 16 | V _{MODE} | Attenuator slope control. Set to logic LOW to enable negative attenuation slope. Set to logic HIGH to enable positive attenuation slope. |
| | — EP | Exposed Pad. Internally connected to GND. Solder this exposed pad to a PCB pad that uses multiple ground vias to achieve the specified RF performance. |

Voltage Variable RF Attenuator
1MHz to 3000MHz
APPLICATIONS INFORMATION
Default Start-up

V_{MODE} must be tied to either GND or Logic High. If the V_{CTRL} pin is left floating, the part will power up in the minimum attenuation state when $V_{MODE} = GND$, or the maximum attenuation state when $V_{MODE} = High$.

 V_{CTRL}

The voltage level on the V_{CTRL} pin is used to control the attenuation of the F2255. At $V_{CTRL} = 0V$, the attenuation is a minimum (maximum) in the negative (positive) slope mode. An increasing (decreasing) voltage on V_{CTRL} produces an increasing (decreasing) attenuation respectively. The V_{CTRL} pin has an on-chip pull-up ESD diode so V_{DD} should be applied before V_{CTRL} is applied (see Recommended Operating Conditions for details). If this sequencing is not possible, then resistor R2 in the application circuit should be set to 1k Ω to limit the current into the V_{CTRL} pin.

 V_{MODE}

The V_{MODE} pin is used to set the slope of the attenuation. The attenuation is varied by V_{CTRL} as described in the next section. Setting V_{MODE} to a logic LOW (HIGH) will set the attenuation slope to negative (positive). A negative (positive) slope is defined as an increased (decreased) attenuation with increasing V_{CTRL} voltage. The Evaluation Kit provides an on-board jumper to manually set the V_{MODE} . Install a jumper on header J2 from V_{MODE} to the pin marked Lo (Hi) to set the device for a negative (positive) slope (see application circuit).

RF1 and RF2 Ports

The F2255 is a bi-directional device, allowing RF1 or RF2 to be used as the RF input. RF1 has some enhanced linearity performance, and therefore should be used as the RF input, when possible, for best results. The F2255 has been designed to accept high RF input power levels; therefore, V_{DD} must be applied prior to the application of RF power to ensure reliability. DC blocking capacitors are required on the RF pins and should be set to a value that results in a low reactance over the frequency range of interest.

Power Supplies

The supply pin should be bypassed with external capacitors to minimize noise and fast transients. Supply noise can degrade noise figure and fast transients can trigger ESD clamps and cause them to fail. Supply voltage change or transients should have a slew rate smaller than 1V/20uS. In addition, all control pins should remain at 0V (+/-0.3V) while the supply voltage ramps or while it returns to zero.

Voltage Variable RF Attenuator

1MHz to 3000MHz

Control Pin Interface

If control signal integrity is a concern and clean signals cannot be guaranteed due to overshoot, undershoot, ringing, etc., the following circuit at the input of control pins 14 and 16 is recommended as shown below.

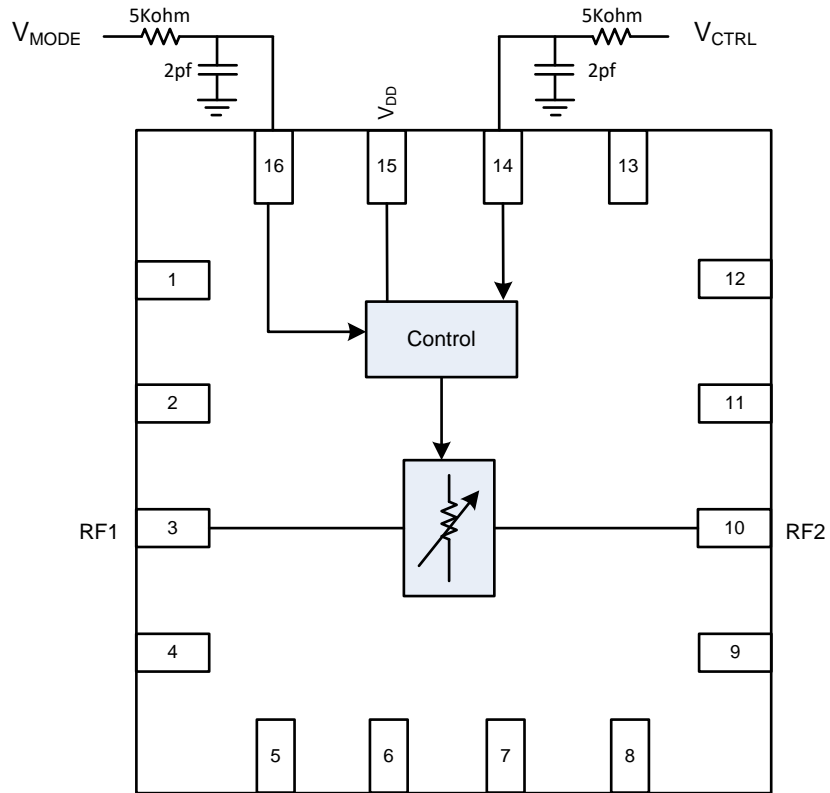

Voltage Variable RF Attenuator

1MHz to 3000MHz

EVKIT / APPLICATIONS CIRCUIT

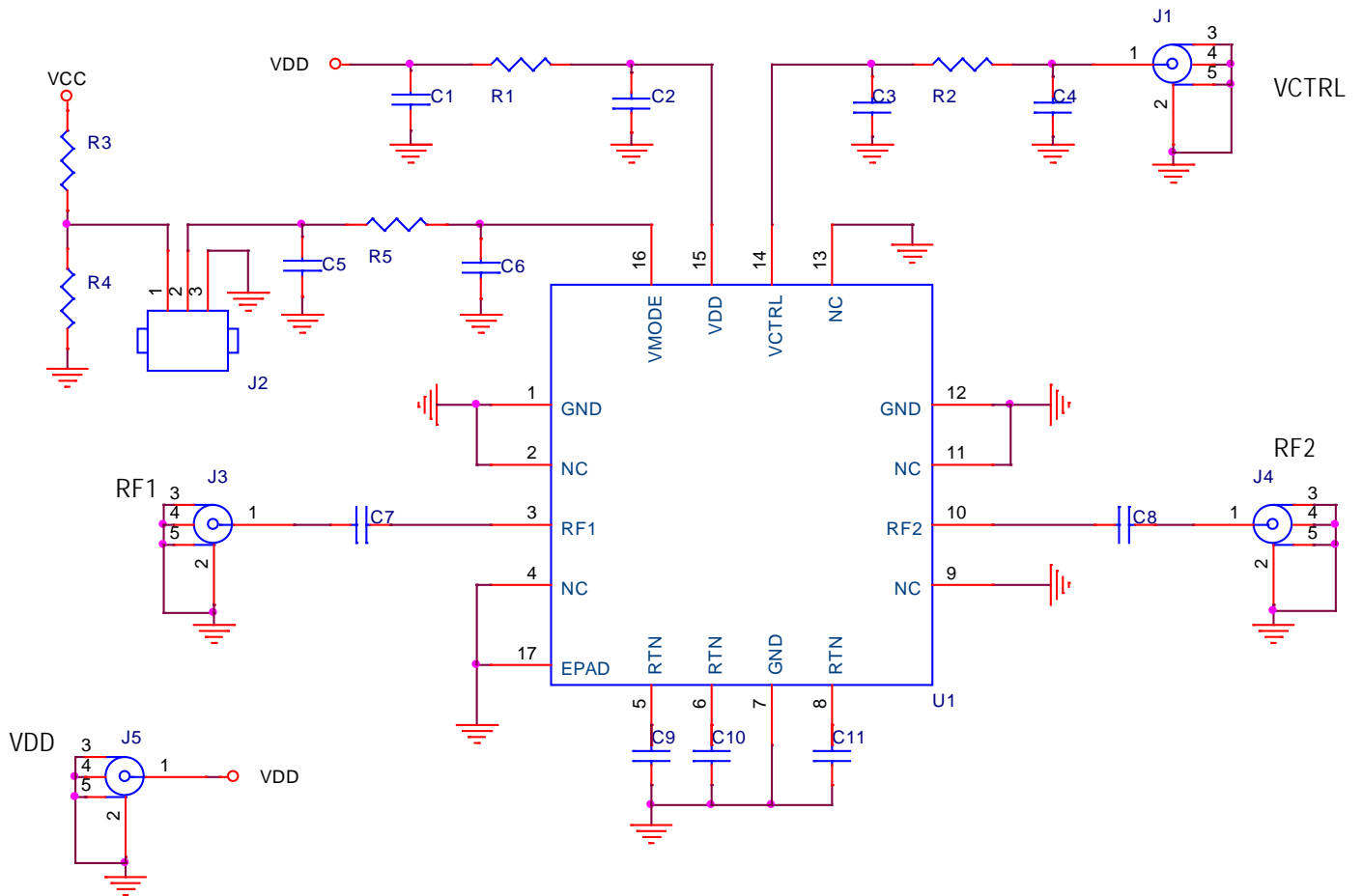

Voltage Variable RF Attenuator

1MHz to 3000MHz

EVKIT PICTURE / LAYOUT (TOP VIEW)

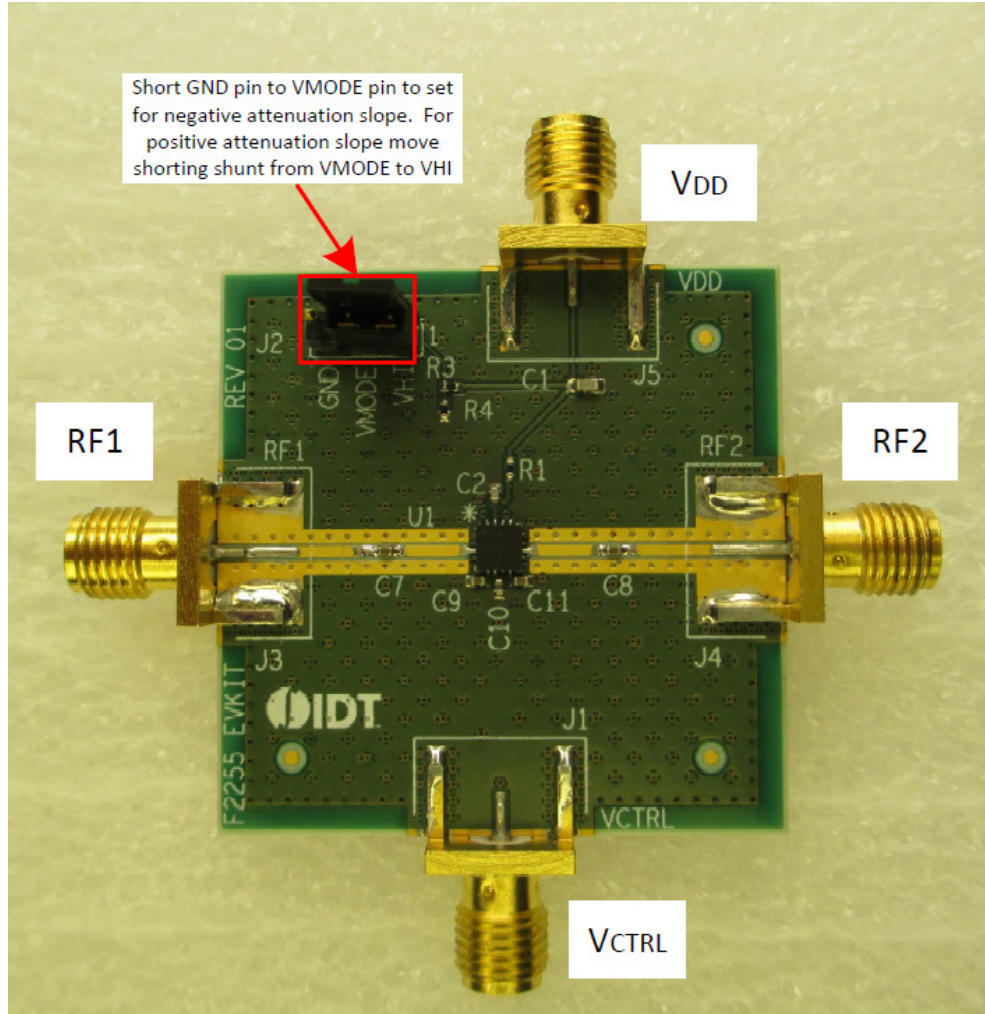

Voltage Variable RF Attenuator

1MHz to 3000MHz

EVKIT PICTURE / LAYOUT (BOTTOM VIEW)

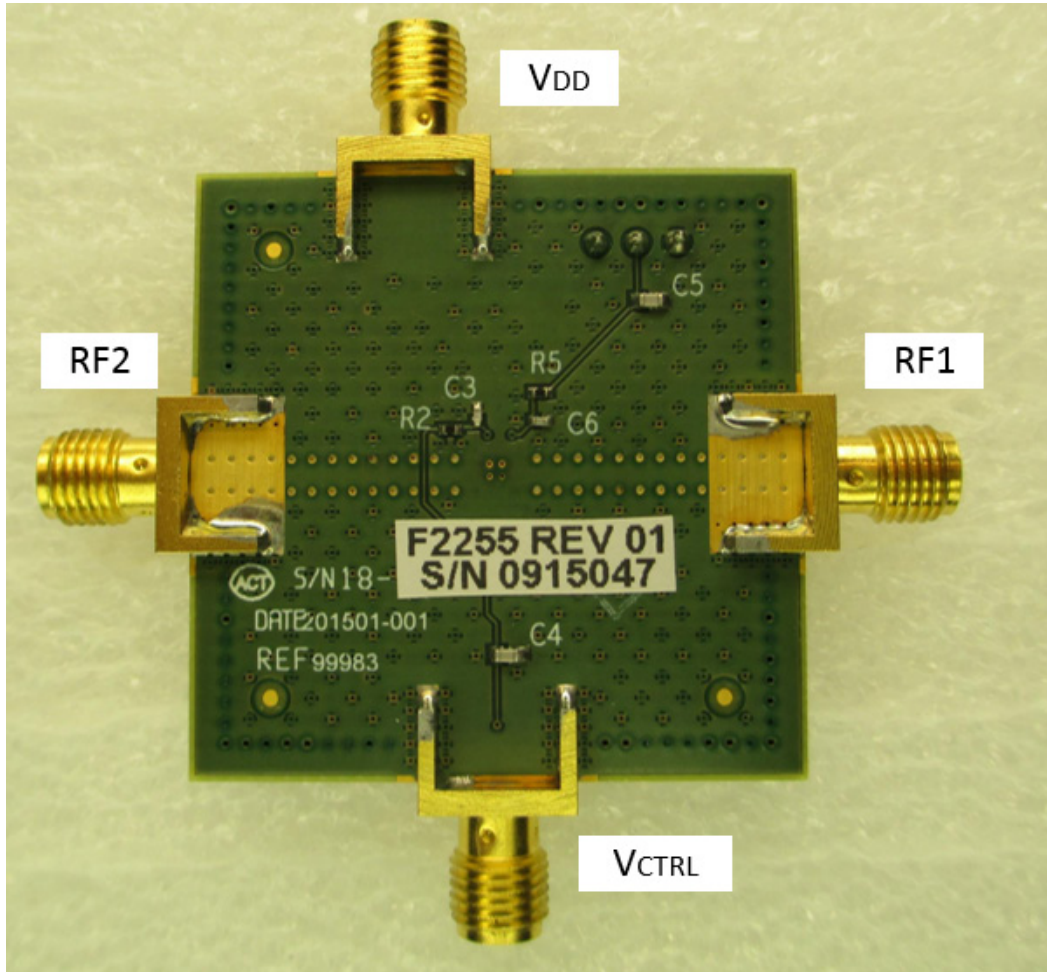

Voltage Variable RF Attenuator

1MHz to 3000MHz

EVKIT BOM

| Part Reference | QTY | DESCRIPTION | Mfr. Part # | Mfr. |
|----------------------|-----|--|----------------|-----------------|
| C1, C4, C5 | 3 | 10nF ±5%, 50V, X7R Ceramic Capacitors (0603) | GRM188R71H103J | Murata |
| C2, C3, C6 | 3 | 1000pF ±5%, 50V, COG Ceramic Capacitors (0402) | GRM1555C1H102J | Murata |
| C7, C8, C9, C10, C11 | 5 | 100nF ±10%, 16V, X7R Ceramic Capacitors (0402) | GRM155R71C104K | Murata |
| R1, R2, R5 | 3 | 0Ω Resistors (0402) | ERJ-2GE0R00X | Panasonic |
| R3, R4 | 2 | 100kΩ ±1%, 1/10W, Resistors (0402) | ERJ-2RKF1003X | Panasonic |
| J1, J3, J4, J5 | 4 | Edge Launch SMA (0.375 inch pitch ground tabs) | 142-0701-851 | Emerson Johnson |
| J2 | 1 | CONN HEADER VERT SGL 3 X 1 POS GOLD | 961103-6404-AR | 3M |
| U1 | 1 | Voltage Variable Attenuator | F2255NLGK | IDT |
| | 1 | Printed Circuit Board | F2255 REV 1 | IDT |

TOP MARKINGS

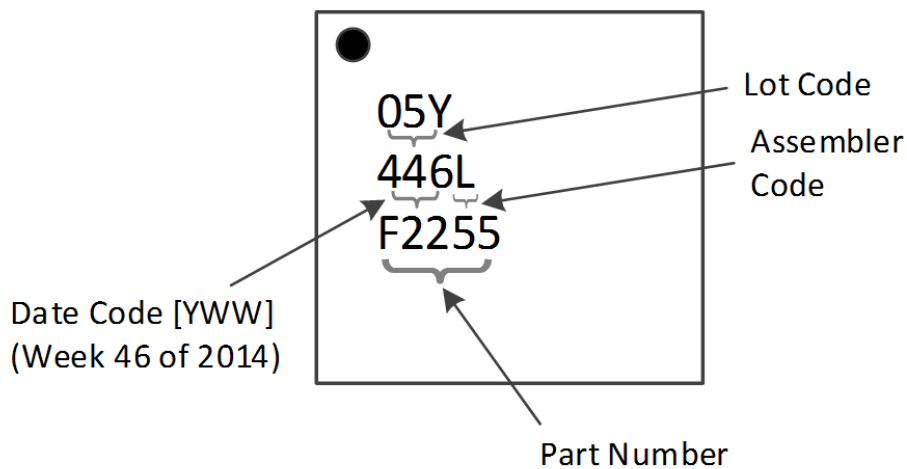

Voltage Variable RF Attenuator**1MHz to 3000MHz**

Revision History

| Revision Date | Description of Change |
|------------------|---|
| May 7, 2021 | <ul style="list-style-type: none">• Changed the corporate branding to Renesas.• Completed other minor changes. |
| February 9, 2018 | Corrected POD drawing, added revision page. |
| January 30, 2017 | Updated GBT limits for I_{DD} , V_{MODE} and V_{CTRL} . |
| November 5, 2015 | Initial release. |

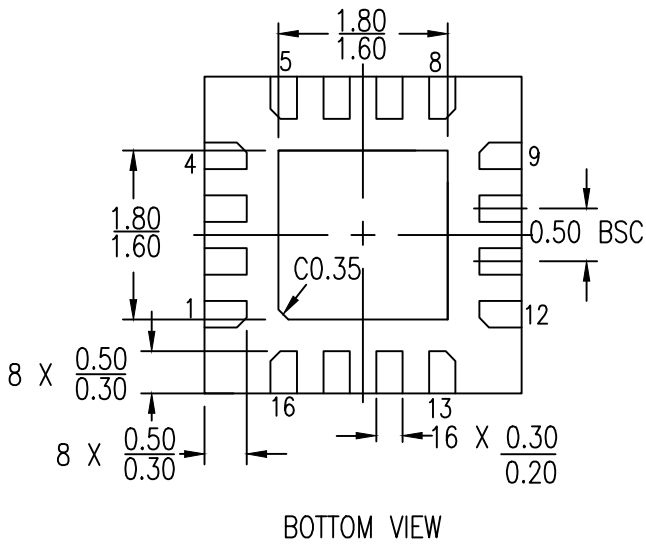
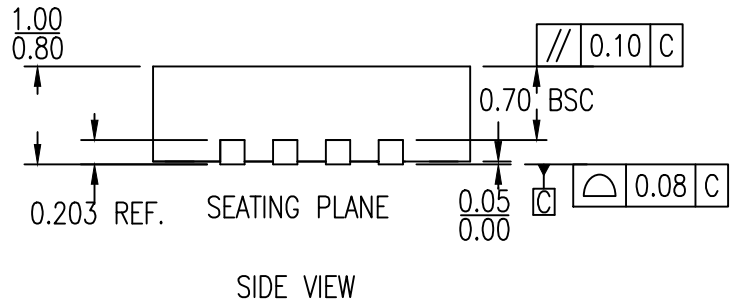
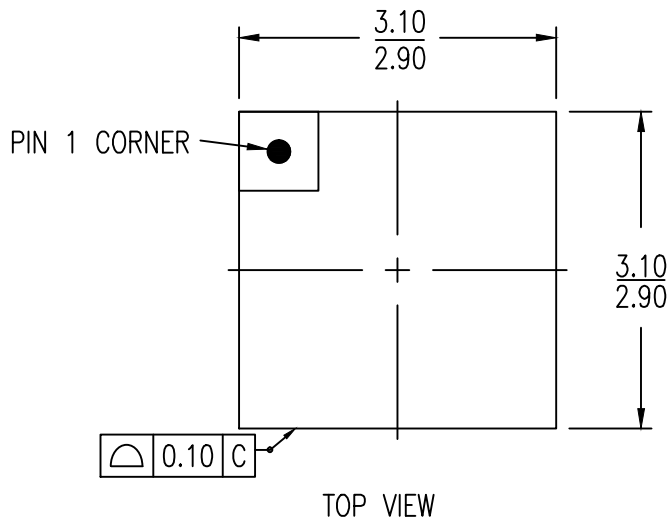

NOTES:
1. ALL DIMENSIONS ARE IN mm. ANGLES IN DEGREES

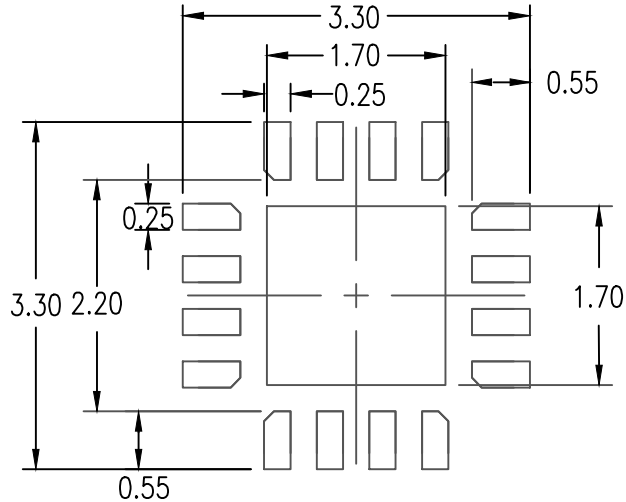

RECOMMENDED LAND PATTERN DIMENSION

NOTES:

1. ALL DIMENSIONS ARE IN mm. ANGLES IN DEGREES
2. TOP DOWN VIEW-AS VIEWED ON PCB
3. LAND PATTERN RECOMMENDATION IS PER IPC-7351B GENERIC REQUIREMENT FOR SURFACE MOUNT DESIGN AND LAND PATTERN

| Package Revision History | | |
|--------------------------|---------|---|
| Date Created | Rev No. | Description |
| Oct 25, 2017 | Rev 04 | Remove Bookmak at Pdf Format & Update Thickness Tolerance |
| Jan 18, 2018 | Rev 05 | Change QFN to VFQFPN |