

EconoPACK™3 module with Trench/Fieldstop IGBT4 and Emitter Controlled diode and NTC

Features

- Electrical features
 - $V_{CES} = 1700\text{ V}$
 - $I_{C\text{nom}} = 150\text{ A} / I_{CRM} = 300\text{ A}$
 - LOW V_{CESat}
 - $T_{vj\text{op}} = 150\text{ °C}$
 - Trench IGBT 4
 - V_{CESat} with positive temperature coefficient
- Mechanical features
 - Integrated NTC temperature sensor
 - Standard housing
 - Solder contact technology
 - Isolated base plate



Typical appearance

Potential applications

- High power converters
- Medium voltage converters

Product validation

- Qualified for industrial applications according to the relevant tests of IEC 60747, 60749 and 60068

Description

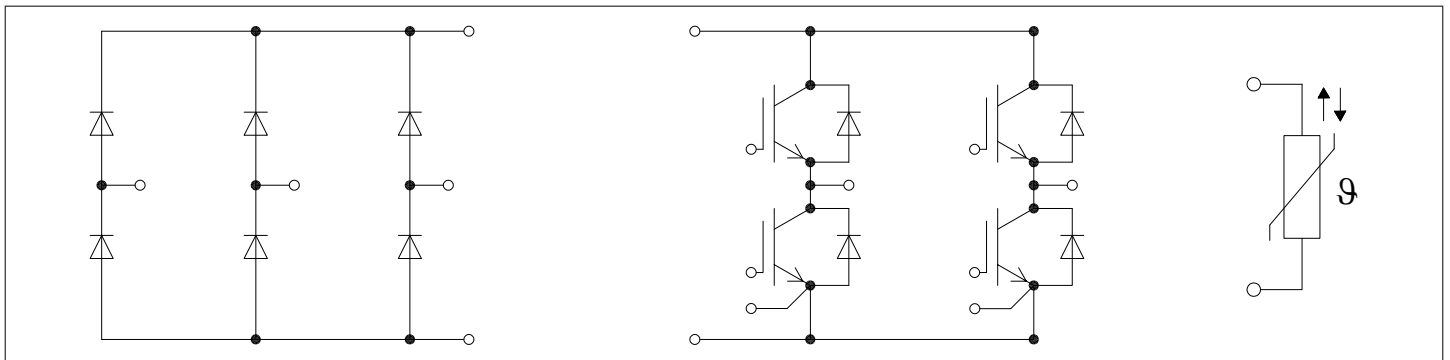

Table of contents

	Description	1
	Features	1
	Potential applications	1
	Product validation	1
	Table of contents	2
1	Package	3
2	IGBT, Inverter	3
3	Diode, Inverter	5
4	Diode, Rectifier	6
5	NTC-Thermistor	7
6	Characteristics diagrams	8
7	Circuit diagram	12
8	Package outlines	12
	Revision history	13
	Disclaimer	14

1 Package

Table 1 Insulation coordination

Parameter	Symbol	Note or test condition	Values	Unit
Isolation test voltage	V_{ISOL}	RMS, $f = 50$ Hz, $t = 1$ min	3.4	kV
Material of module baseplate			Cu	
Internal Isolation		basic insulation (class 1, IEC 61140)	Al_2O_3	
Creepage distance	d_{Creep}	terminal to heatsink	10.0	mm
Clearance	d_{Clear}	terminal to heatsink	7.5	mm
Comparative tracking index	CTI		> 225	
RTI Elec.	RTI	housing	140	°C

Table 2 Characteristic values

Parameter	Symbol	Note or test condition	Values			Unit
			Min.	Typ.	Max.	
Stray inductance module	L_{SCE}			33		nH
Module lead resistance, terminals - chip	$R_{AA'+CC'}$	$T_C = 25^\circ C$, per switch		3		mΩ
Module lead resistance, terminals - chip	$R_{CC'+EE'}$	$T_C = 25^\circ C$, per switch		2		mΩ
Storage temperature	T_{stg}		-40		125	°C
Mounting torque for modul mounting	M	- Mounting according to valid application note	M5, Screw	3	6	Nm
Weight	G			300		g

2 IGBT, Inverter

Table 3 Maximum rated values

Parameter	Symbol	Note or test condition	Values	Unit
Collector-emitter voltage	V_{CES}	$T_{vj} = 25^\circ C$	1700	V
Implemented collector current	I_{CN}		150	A
Continous DC collector current	I_{CDC}	$T_{vj\ max} = 175^\circ C$ $T_C = 90^\circ C$	150	A
Repetitive peak collector current	I_{CRM}	$t_p = 1$ ms	300	A
Gate-emitter peak voltage	V_{GES}		±20	V

Table 4 Characteristic values

Parameter	Symbol	Note or test condition	Values			Unit
			Min.	Typ.	Max.	
Collector-emitter saturation voltage	$V_{CE\ sat}$	$I_C = 150\ A, V_{GE} = 15\ V$	$T_{vj} = 25\ ^\circ C$	1.70	2.20	V
			$T_{vj} = 125\ ^\circ C$	2.05		
			$T_{vj} = 150\ ^\circ C$	2.10		
Gate threshold voltage	V_{GEth}	$I_C = 6\ mA, V_{CE} = V_{GE}, T_{vj} = 25\ ^\circ C$	5.35	5.80	6.25	V
Gate charge	Q_G	$V_{GE} = \pm 15\ V$		1.53		μC
Internal gate resistor	R_{Gint}	$T_{vj} = 25\ ^\circ C$		4.6		Ω
Input capacitance	C_{ies}	$f = 1000\ kHz, T_{vj} = 25\ ^\circ C, V_{CE} = 25\ V, V_{GE} = 0\ V$		12.3		nF
Reverse transfer capacitance	C_{res}	$f = 1000\ kHz, T_{vj} = 25\ ^\circ C, V_{CE} = 25\ V, V_{GE} = 0\ V$		0.4		nF
Collector-emitter cut-off current	I_{CES}	$V_{CE} = 1700\ V, V_{GE} = 0\ V$	$T_{vj} = 25\ ^\circ C$		1	mA
Gate-emitter leakage current	I_{GES}	$V_{CE} = 0\ V, V_{GE} = 20\ V, T_{vj} = 25\ ^\circ C$			100	nA
Turn-on delay time (inductive load)	t_{don}	$I_C = 150\ A, V_{CE} = 900\ V, V_{GE} = \pm 15\ V, R_{Gon} = 0.91\ \Omega$	$T_{vj} = 25\ ^\circ C$	0.205		μs
			$T_{vj} = 125\ ^\circ C$	0.228		
			$T_{vj} = 150\ ^\circ C$	0.234		
Rise time (inductive load)	t_r	$I_C = 150\ A, V_{CE} = 900\ V, V_{GE} = \pm 15\ V, R_{Gon} = 0.91\ \Omega$	$T_{vj} = 25\ ^\circ C$	0.064		μs
			$T_{vj} = 125\ ^\circ C$	0.074		
			$T_{vj} = 150\ ^\circ C$	0.076		
Turn-off delay time (inductive load)	t_{doff}	$I_C = 150\ A, V_{CE} = 900\ V, V_{GE} = \pm 15\ V, R_{Goff} = 0.91\ \Omega$	$T_{vj} = 25\ ^\circ C$	0.525		μs
			$T_{vj} = 125\ ^\circ C$	0.680		
			$T_{vj} = 150\ ^\circ C$	0.713		
Fall time (inductive load)	t_f	$I_C = 150\ A, V_{CE} = 900\ V, V_{GE} = \pm 15\ V, R_{Goff} = 0.91\ \Omega$	$T_{vj} = 25\ ^\circ C$	0.594		μs
			$T_{vj} = 125\ ^\circ C$	0.833		
			$T_{vj} = 150\ ^\circ C$	0.892		
Turn-on energy loss per pulse	E_{on}	$I_C = 150\ A, V_{CE} = 900\ V, L_\sigma = 35\ nH, V_{GE} = \pm 15\ V, R_{Gon} = 0.91\ \Omega, di/dt = 1250\ A/\mu s (T_{vj} = 150\ ^\circ C)$	$T_{vj} = 25\ ^\circ C$	47.6		mJ
			$T_{vj} = 125\ ^\circ C$	63.9		
			$T_{vj} = 150\ ^\circ C$	68.8		
Turn-off energy loss per pulse	E_{off}	$I_C = 150\ A, V_{CE} = 900\ V, L_\sigma = 35\ nH, V_{GE} = \pm 15\ V, R_{Goff} = 0.91\ \Omega, dv/dt = 4150\ V/\mu s (T_{vj} = 150\ ^\circ C)$	$T_{vj} = 25\ ^\circ C$	50.8		mJ
			$T_{vj} = 125\ ^\circ C$	69.3		
			$T_{vj} = 150\ ^\circ C$	74.2		
SC data	I_{SC}	$V_{GE} \leq 15\ V, V_{CC} = 1000\ V, V_{CEmax} = V_{CES} - L_{sCE} * di/dt$	$t_p \leq 10\ \mu s, T_{vj} = 150\ ^\circ C$	600		A
Thermal resistance, junction to case	R_{thJC}	per IGBT			0.195	K/W

Table 4 Characteristic values (continued)

Parameter	Symbol	Note or test condition	Values			Unit
			Min.	Typ.	Max.	
Thermal resistance, case to heatsink	R_{thCH}	per IGBT, $\lambda_{grease} = 1 \text{ W/(m}^2\text{K)}$		0.0700		K/W
Temperature under switching conditions	T_{vjop}		-40		150	°C

3 Diode, Inverter

Table 5 Maximum rated values

Parameter	Symbol	Note or test condition	Values	Unit	
Repetitive peak reverse voltage	V_{RRM}	$T_{vj} = 25 \text{ }^\circ\text{C}$	1700	V	
Continuous DC forward current	I_F		150	A	
Repetitive peak forward current	I_{FRM}	$t_p = 1 \text{ ms}$	300	A	
I^2t - value	I^2t	$t_p = 10 \text{ ms}, V_R = 0 \text{ V}$	$T_{vj} = 125 \text{ }^\circ\text{C}$	3950	A^2s
			$T_{vj} = 150 \text{ }^\circ\text{C}$	3750	

Table 6 Characteristic values

Parameter	Symbol	Note or test condition	Values			Unit	
			Min.	Typ.	Max.		
Forward voltage	V_F	$I_F = 150 \text{ A}, V_{GE} = 0 \text{ V}$	$T_{vj} = 25 \text{ }^\circ\text{C}$		1.80	2.65	V
			$T_{vj} = 125 \text{ }^\circ\text{C}$		1.90		
			$T_{vj} = 150 \text{ }^\circ\text{C}$		1.95		
Peak reverse recovery current	I_{RM}	$V_R = 900 \text{ V}, I_F = 150 \text{ A}, V_{GE} = -15 \text{ V}, -di_F/dt = 1250 \text{ A}/\mu\text{s} (T_{vj} = 150 \text{ }^\circ\text{C})$	$T_{vj} = 25 \text{ }^\circ\text{C}$		93.3		A
			$T_{vj} = 125 \text{ }^\circ\text{C}$		101		
			$T_{vj} = 150 \text{ }^\circ\text{C}$		102		
Recovered charge	Q_r	$V_R = 900 \text{ V}, I_F = 150 \text{ A}, V_{GE} = -15 \text{ V}, -di_F/dt = 1250 \text{ A}/\mu\text{s} (T_{vj} = 150 \text{ }^\circ\text{C})$	$T_{vj} = 25 \text{ }^\circ\text{C}$		33.9		μC
			$T_{vj} = 125 \text{ }^\circ\text{C}$		57.9		
			$T_{vj} = 150 \text{ }^\circ\text{C}$		64.7		
Reverse recovery energy	E_{rec}	$V_R = 900 \text{ V}, I_F = 150 \text{ A}, V_{GE} = -15 \text{ V}, -di_F/dt = 1250 \text{ A}/\mu\text{s} (T_{vj} = 150 \text{ }^\circ\text{C})$	$T_{vj} = 25 \text{ }^\circ\text{C}$		17.3		mJ
			$T_{vj} = 125 \text{ }^\circ\text{C}$		32.8		
			$T_{vj} = 150 \text{ }^\circ\text{C}$		37.1		
Thermal resistance, junction to case	R_{thJC}	per diode			0.365	K/W	

Table 6 Characteristic values (continued)

Parameter	Symbol	Note or test condition	Values			Unit
			Min.	Typ.	Max.	
Thermal resistance, case to heatsink	R_{thCH}	per diode, $\lambda_{grease} = 1 \text{ W/(m}^2\text{K)}$		0.0680		K/W
Temperature under switching conditions	$T_{vj,op}$		-40		150	°C

4 Diode, Rectifier

Table 7 Maximum rated values

Parameter	Symbol	Note or test condition	Values	Unit	
Repetitive peak reverse voltage	V_{RRM}	$T_{vj} = 25 \text{ }^\circ\text{C}$	1800	V	
Maximum RMS forward current per chip	I_{FRMSM}	$T_C = 95 \text{ }^\circ\text{C}$	150	A	
Maximum RMS current at rectifier output	I_{RMSM}	$T_C = 95 \text{ }^\circ\text{C}$	150	A	
Surge forward current	I_{FSM}	$t_p = 10 \text{ ms}$	$T_{vj} = 25 \text{ }^\circ\text{C}$	1460	A
			$T_{vj} = 150 \text{ }^\circ\text{C}$	1260	
I^2t - value	I^2t	$t_p = 10 \text{ ms}$	$T_{vj} = 25 \text{ }^\circ\text{C}$	10700	A ² s
			$T_{vj} = 150 \text{ }^\circ\text{C}$	7940	

Table 8 Characteristic values

Parameter	Symbol	Note or test condition	Values			Unit
			Min.	Typ.	Max.	
Forward voltage	V_F	$T_{vj} = 150 \text{ }^\circ\text{C}$, $I_F = 150 \text{ A}$		1.00		V
Threshold voltage	$V_{(TO)}$	$T_{vj} = 150 \text{ }^\circ\text{C}$		0.76		V
Slope resistance	r_t	$T_{vj} = 150 \text{ }^\circ\text{C}$		1.6		mΩ
Reverse current	I_r	$T_{vj} = 150 \text{ }^\circ\text{C}$, $V_R = 1800 \text{ V}$		1		mA
Thermal resistance, junction to case	R_{thJC}	per diode			0.364	K/W
Thermal resistance, case to heatsink	R_{thCH}	per diode, $\lambda_{Paste} = 1 \text{ W/(m}^2\text{K)}$ / $\lambda_{grease} = 1 \text{ W/(m}^2\text{K)}$		0.0680		K/W
Temperature under switching conditions	$T_{vj,op}$		-40		150	°C

Note: The current under continuous operation is limited to 50 A rms per connector pin.

5 NTC-Thermistor

Table 9 Characteristic values

Parameter	Symbol	Note or test condition	Values			Unit
			Min.	Typ.	Max.	
Rated resistance	R_{25}	$T_{NTC} = 25\text{ °C}$		5		kΩ
Deviation of R_{100}	$\Delta R/R$	$T_{NTC} = 100\text{ °C}, R_{100} = 493\text{ }\Omega$	-5		5	%
Power dissipation	P_{25}	$T_{NTC} = 25\text{ °C}$			20	mW
B-value	$B_{25/50}$	$R_2 = R_{25} \exp[B_{25/50}(1/T_2 - 1/(298,15\text{ K}))]$		3375		K
B-value	$B_{25/80}$	$R_2 = R_{25} \exp[B_{25/80}(1/T_2 - 1/(298,15\text{ K}))]$		3411		K
B-value	$B_{25/100}$	$R_2 = R_{25} \exp[B_{25/100}(1/T_2 - 1/(298,15\text{ K}))]$		3433		K

Note: Specification according to the valid application note.

6 Characteristics diagrams

output characteristic (typical), IGBT, Inverter

$I_C = f(V_{CE})$
 $V_{GE} = 15\text{ V}$

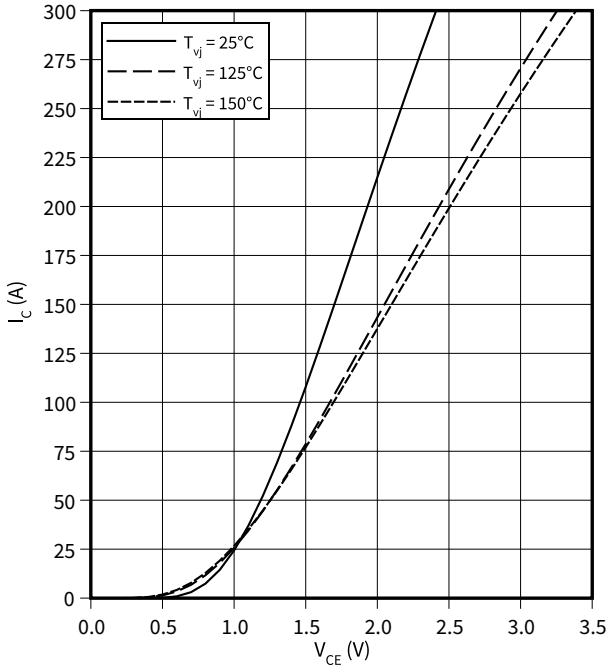

output characteristic (typical), IGBT, Inverter

$I_C = f(V_{CE})$
 $T_{vj} = 150\text{ °C}$

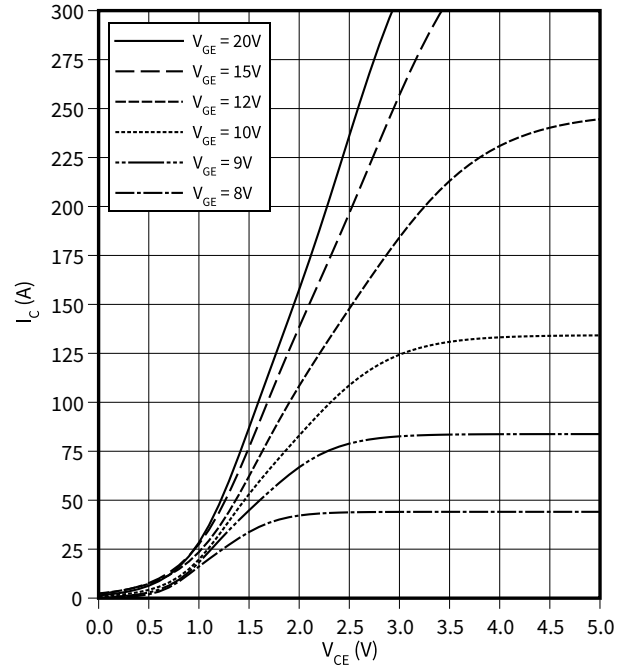

transfer characteristic (typical), IGBT, Inverter

$I_C = f(V_{GE})$
 $V_{CE} = 20\text{ V}$

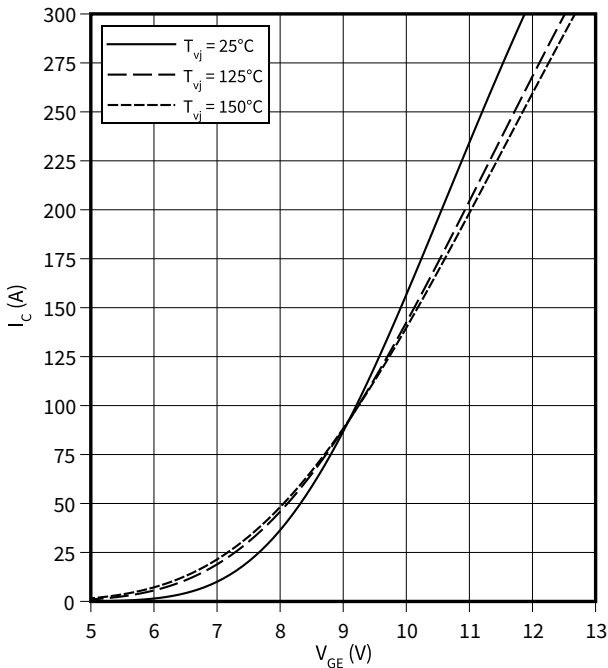

switching losses (typical), IGBT, Inverter

$E = f(I_C)$
 $R_{Goff} = 0.91\ \Omega, R_{Gon} = 0.91\ \Omega, V_{CE} = 900\text{ V}, V_{GE} = -15 / 15\text{ V}$

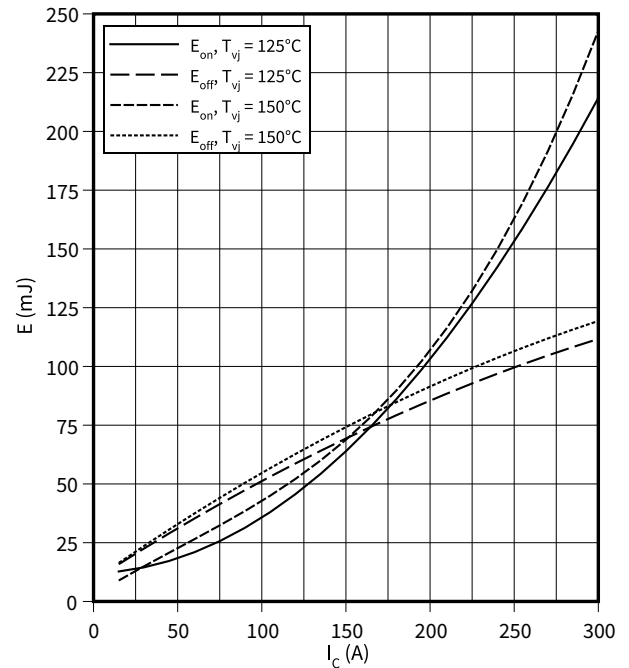

6 Characteristics diagrams

switching losses (typical), IGBT, Inverter

$E = f(R_G)$

$I_C = 150 \text{ A}, V_{CE} = 900 \text{ V}, V_{GE} = -15 / 15 \text{ V}$

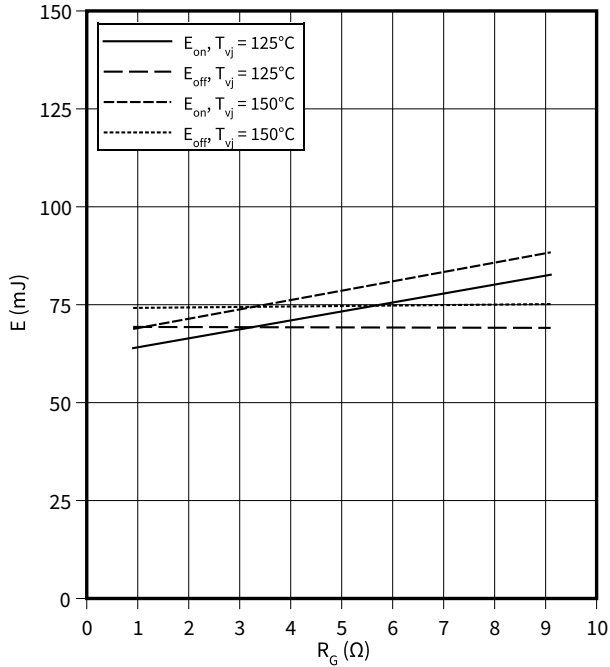

switching times (typical), IGBT, Inverter

$t = f(I_C)$

$R_{Goff} = 0.91 \Omega, R_{Gon} = 0.91 \Omega, V_{CE} = 900 \text{ V}, V_{GE} = -15 / 15 \text{ V}, T_{vj} = 150 \text{ °C}$

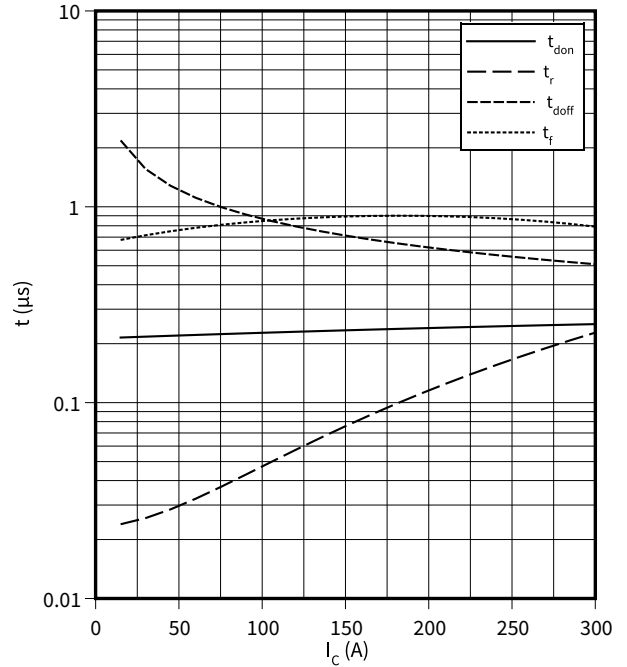

switching times (typical), IGBT, Inverter

$t = f(R_G)$

$I_C = 150 \text{ A}, V_{CE} = 900 \text{ V}, V_{GE} = -15 / 15 \text{ V}, T_{vj} = 150 \text{ °C}$

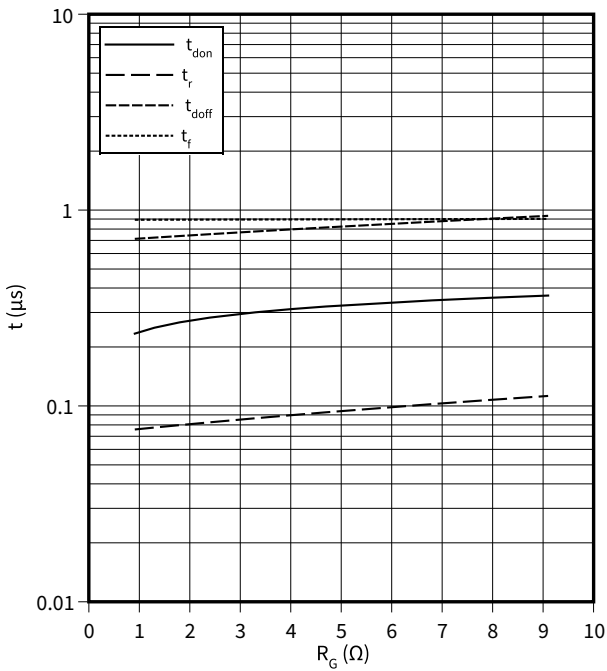

transient thermal impedance, IGBT, Inverter

$Z_{th} = f(t)$

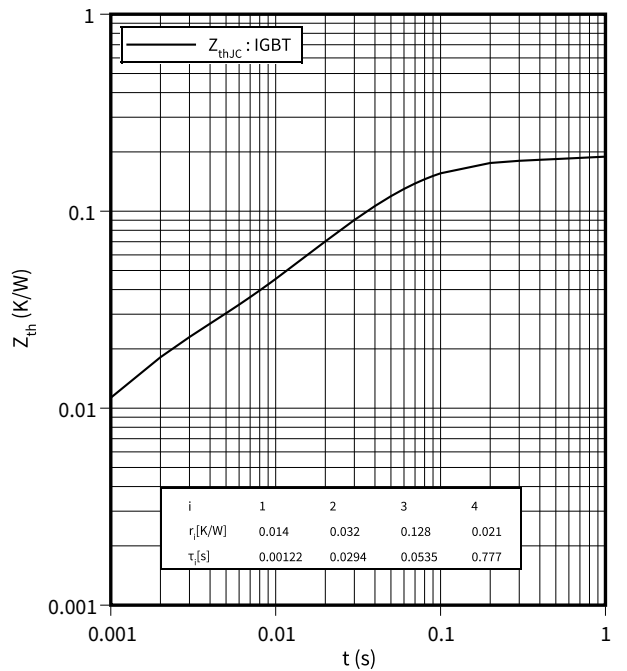

6 Characteristics diagrams

reverse bias safe operating area (RBSOA), IGBT, Inverter

$I_C = f(V_{CE})$

$R_{Goff} = 0.91 \Omega$, $V_{GE} = \pm 15 \text{ V}$, $T_{vj} = 150 \text{ }^\circ\text{C}$

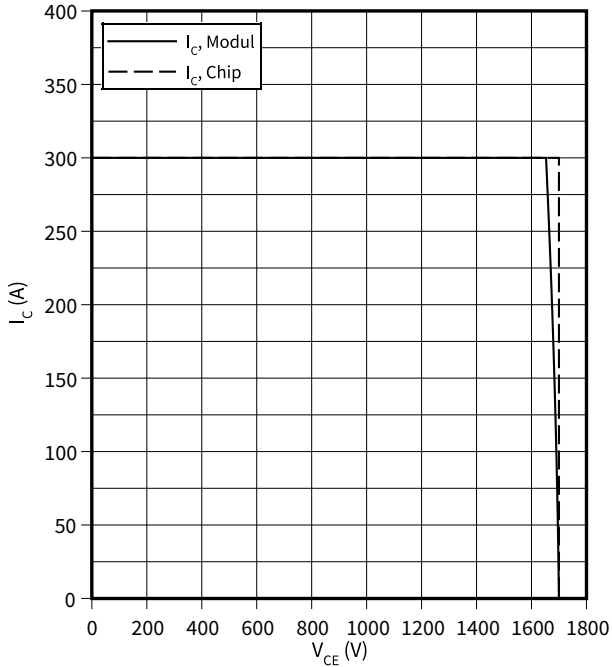

forward characteristic (typical), Diode, Inverter

$I_F = f(V_F)$

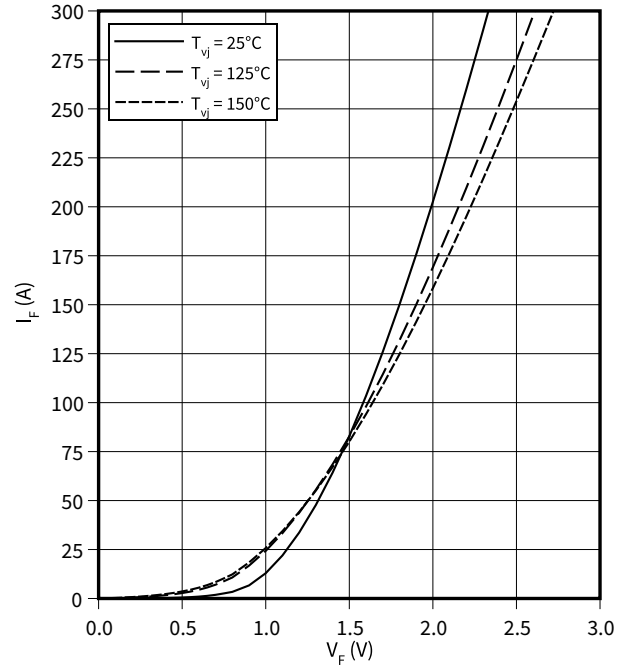

switching losses (typical), Diode, Inverter

$E_{rec} = f(I_F)$

$V_{CE} = 900 \text{ V}$, $R_{Gon} = R_{Gon}(\text{IGBT})$

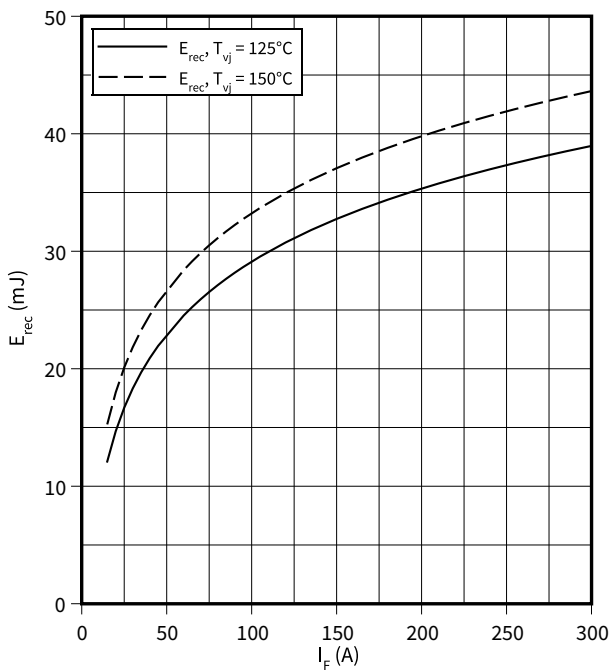

switching losses (typical), Diode, Inverter

$E_{rec} = f(R_G)$

$V_{CE} = 900 \text{ V}$, $I_F = 150 \text{ A}$

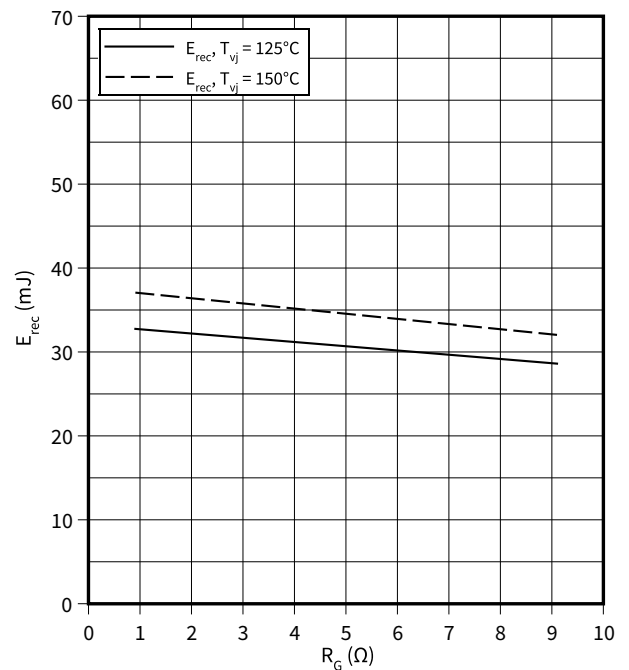

6 Characteristics diagrams

transient thermal impedance , Diode, Inverter

$Z_{th} = f(t)$

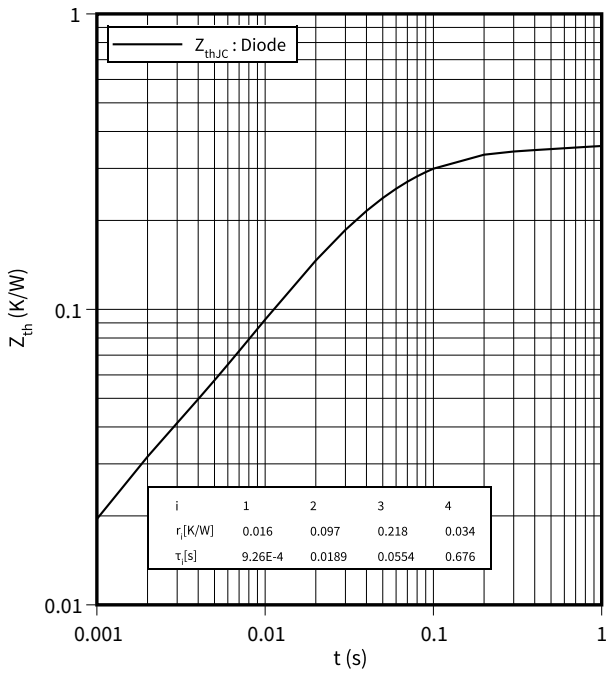

Forward characteristic (typical), Diode, Rectifier

$I_F = f(V_F)$

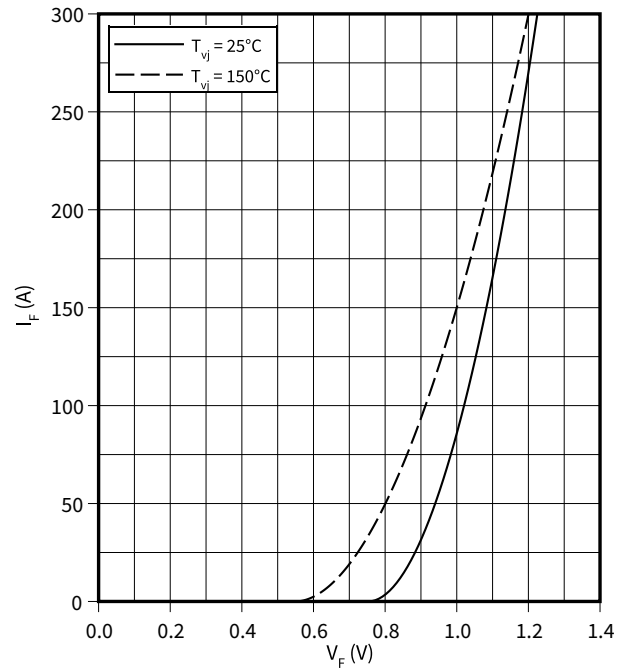

Transient thermal impedance, Diode, Rectifier

$Z_{th} = f(t)$

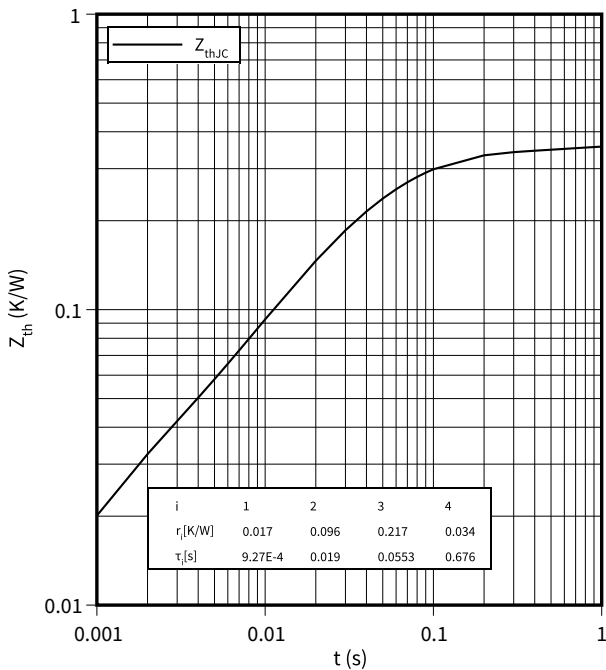

Temperature characteristic (typical), NTC-Thermistor

$R = f(T_{NTC})$

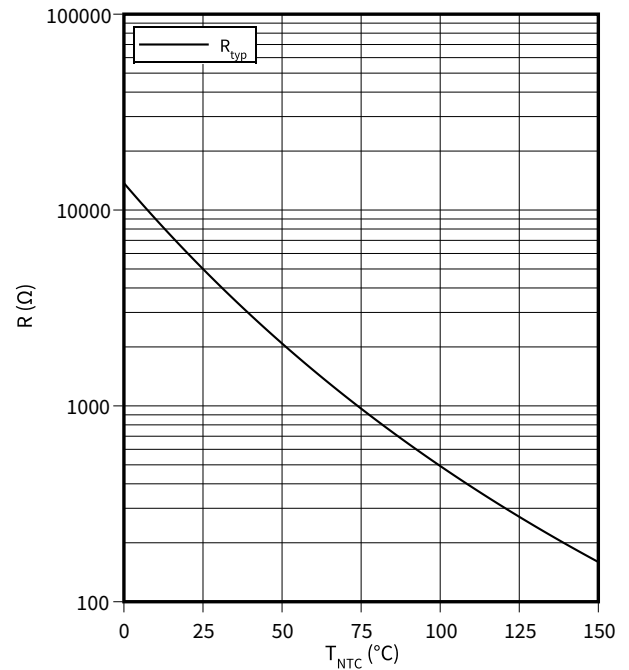

7 Circuit diagram

7 Circuit diagram

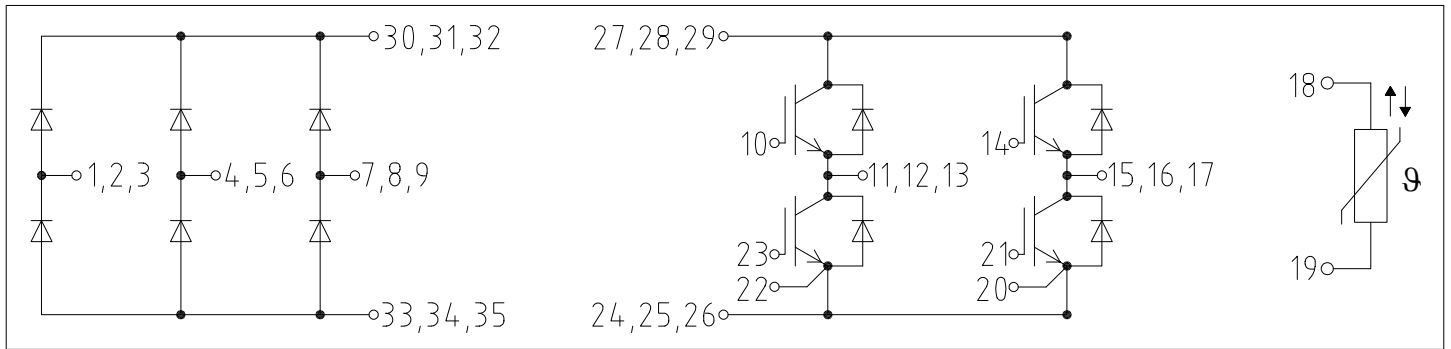

Figure 2

8 Package outlines

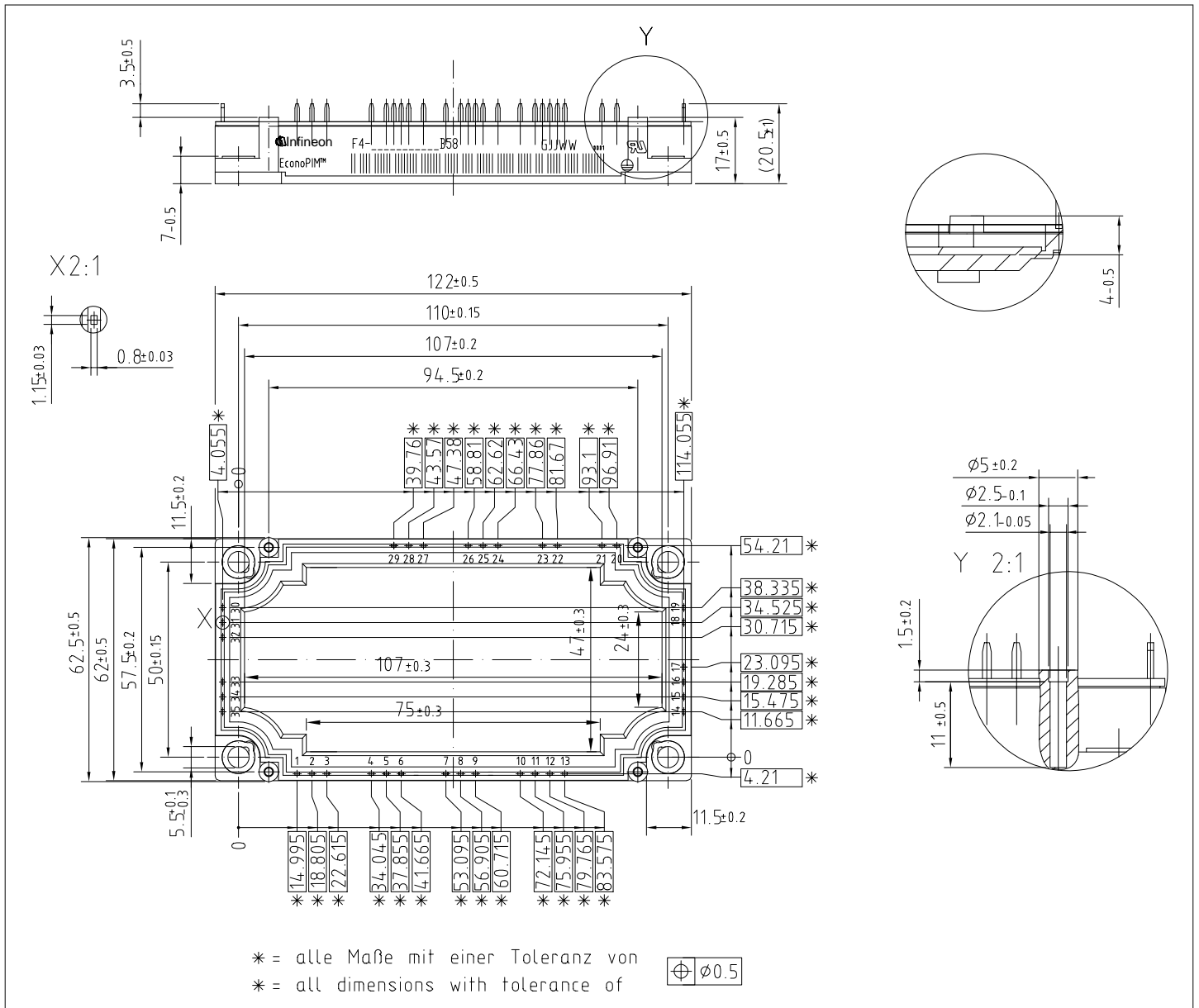

Figure 3

Revision history

Revision history

Document revision	Date of release	Description of changes
1.00	2021-05-11	Final datasheet