

EMI

ENCLOSURE SHIELDING SOLUTIONS



**LEADER
TECH** 
a HEICO company

The Leading Edge in EMI Shielding Technology



SHIELDING SELECTION CONSIDERATIONS

Consider these important factors in the selection of appropriate shielding products for your design:

- n Operating Frequency
- n Materials Compatibility
- n Load/Forces
- n Corrosive Considerations
- n Commercial or Military Worldwide Compliance
- n Operating Environment
- n Cycle Life
- n Cost
- n Material Thickness/Alloy
- n Attenuation Performance
- n Fastening/Mounting Methods
- n Storage Environment
- n Nuclear, Biological, Chemical (NBC)
- n Shielding/Grounding/Other
- n Electrical Requirements
- n Space/Weight Considerations
- n Product Safety
- n Recyclability

QUICK REFERENCE PRODUCT SELECTION CHART

PARAMETERS	TechSIL ELASTOMER SHEETS	TechSIL ELASTOMER GASKETS	CuBe METAL GASKETS	FSG FABRIC SHIELDING GASKETS	CFS CONDUCTIVE FOAM	TechMESH KNITTED WIRE	TechMESH COMBO STRIP
High Cycling	Good	Good	Excellent	Very Good	Fair	Good	Good
Wiping Applications	N/A	Good	Excellent	Good	N/A	Fair	Fair
Dust Protection	Excellent	Excellent	N/A	Very Good	Very Good	Fair	Excellent
Moisture Protection	Excellent	Excellent	N/A	N/A	N/A	N/A	Excellent
Deflection %	10-20%	15-50%	15-85%	30-50%	30-60%	20-50%	20-50%
Design Flexibility	Excellent	Excellent	Very Good	Excellent	Excellent	Good	Very Good
Finish Options	Very Good	Very Good	Excellent	Good	Fair	Good	Good
I/O Applications	Excellent	Fair	Fair	Very Good	Excellent	Fair	Fair
Shield Effectiveness	Excellent	Excellent	Excellent	Excellent	Very Good	Excellent	Excellent
Tooling/NRE	Low	None	None	None/Low	Low	None	Low
Part Cost	\$\$\$	\$\$\$	\$\$\$	\$	\$\$	\$	\$\$
Lead Times	Very Good	Very Good	Excellent	Excellent	Very Good	Very Good	Good

Notice:

Leader Tech cannot guarantee that the same test data as described herein will be obtained. Thus, it is recommended that each user make their own tests to confirm laboratory test data and determine suitability of products for their particular application.

The products described in this catalog shall be standard quality, however, the products in this catalog are sold without warranty of fitness for a particular purpose, either expressed or implied, except to the extent expressly stated on Leader Tech's quotation or order acknowledgment. Leader Tech does not warrant that devices incorporating one or more of the products described in this catalog will be free of conflict with existing or future patents of third parties. All risks of lack of fitness, patent infringement, and the like are assumed by the user. Furthermore, nothing contained herein shall be construed as recommendation to make, use, or sell any product or process in conflict with existing or future patents.

TABLE OF CONTENTS

4	Application of Fingerstock Gaskets	
5	Compression/Deflection Performance and EMI Shielding Effectiveness	
6	Ordering Information & Adhesive Mounting Instructions	
7	Metals Galvanic Compatibility Chart	
8	BeCu Low Profile Series	
8	BeCu PCI Series	
9	BeCu Adhesive Mount Series	
9	BeCu Dome Top Series.....	
10	BeCu Slot Mount Series	
12	BeCu Folded Series	
14	BeCu Twist Series	
16	BeCu Clip-On Series.....	
18	BeCu Grounding Series.....	
19	BeCu Contact Series	
22	Metal D-Subs	
23	Precision Metal Stampings.....	
24	TechSIL Conductive Elastomers	
25	TechSIL Oriented Wire	
26	TechMESH Knitted Wire.....	
27	TechMESH Elastomer Core Wire	
28	TechMESH Combo Strip.....	
29	TechMESH Tape	
30	FSG Fabric Shielding Gaskets	
35	Shielding Fabrics & Conductive Tapes.....	
36	CFS Conductive Foam Shielding Material	
37	Custom and Die-Cut Shielding Gaskets.....	
39	Products and Literature.....	

APPLICATION OF FINGERSTOCK GASKETS

EMI designers know and trust the consistent performance of Fingerstock (CuBe) gaskets. To date, CuBe yields the best electrical spring contact available in this industry. The copper beryllium mills have well established techniques and for decades have produced CuBe alloys per ASTM, SAE, JIS, and DIN specifications.

Leader Tech uses only proven technology in creating copper beryllium springs, contacts and gaskets. Beginning with Alloy 25 (1/4 hard) BeCu, we stamp, form, and post heat-treat to a hardness of 340 to 390 DPH. This process is preferred in the EMI shielding industry because it has proven to produce the best electrical spring contacts. Leader Tech CuBe EMI shielding gaskets are the most reliable in the industry.

Leader Tech manufactures a wide variety of standard styles and sizes of CuBe gaskets. These gaskets operate in spaces from .010 inches up to .410 inches. Using CuBe materials as thin as .002 inch, we also offer many styles as soft gaskets that provide the low compression force needed in many applications. Leader Tech also designs and manufactures custom spring contacts and gaskets.



FINGERSTOCK GASKETS DO TWO THINGS VERY WELL:

1. Their mechanical spring characteristics far surpass all other gaskets in the industry.
2. They offer the highest EMI shielding effectiveness.

Leader Tech has been designing and manufacturing Fingerstock Gaskets since the early days of the computer and electronics industries. We combine these years of manufacturing and EMI experience with one key ingredient – the needs of the customer.

Our innovative Fingerstock Gasket designs are a direct result of our experience and customer input. Our Compact PCI line of EMI Gaskets is an example of a design that was driven by the needs of a customer and evolved into a line of gaskets that meet all the requirements for Compact PCI faceplate standards while providing superior mechanical and shielding performance.

Leader Tech offers many standard off-the-shelf Fingerstock Gaskets as well as the engineering and custom manufacturing experience to help you solve your application. Whether you need one prototype or a large quantity order, our team at Leader Tech is available to respond to your needs.



COMPRESSION/DEFLECTION PERFORMANCE

Leader Tech. Part No.	Design Compressed Height	Compression Force (lbs./linear ft.)
3-23T	0.018 (0.46)	25
6-34T	0.049 (1.24)	33
6-50T2	0.049 (1.24)	43
9-19UD	0.072 (1.83)	30
11-32RH	0.035 (0.89)	34
11-45C	0.090 (2.29)	19

Leader Tech. Part No.	Design Compressed Height	Compression Force (lbs./linear ft.)
14-45DT	0.098 (2.49)	24
22-60AH	0.140 (3.56)	25
22-60RH	0.070 (1.78)	48
23-76FSC	0.130 (3.30)	34
25-109C	0.140 (3.56)	36
25-78FS	0.150 (3.81)	36

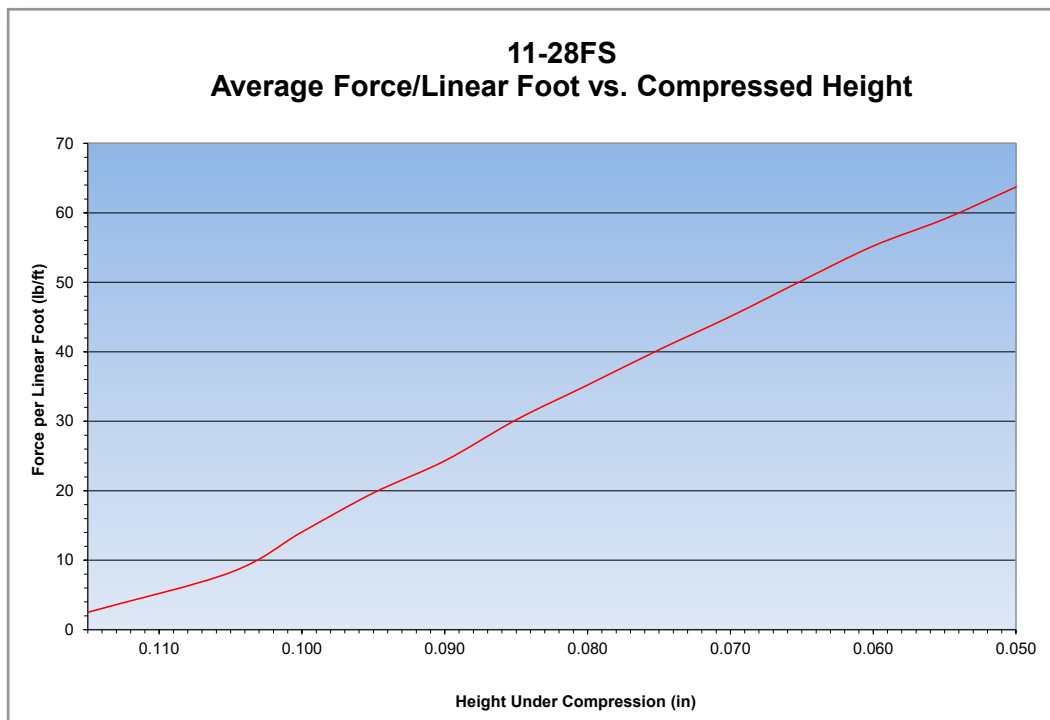

The data presented is based on testing and to our knowledge is accurate and true. Since applications, test methods, and test procedures may vary, we recommend that users of our products perform their own test to assure the suitability of these specific applications. We offer no product warranty, either expressed or implied, except that any product proven defective will be replaced. Freedom from present or future patent infringement cannot be guaranteed, nor can the suitability of our products for specific applications.

ORDERING INFORMATION

When placing an order or requesting a quotation, please give part number, your required finish I.D. from the chart below, and required length.

PART NUMBER EXAMPLE:		
Stock Item	Finish Code	Length
11-S-32RH	- SN -	16

The above example is the "Slot Mount Series" gasket shown on page 11. The height is .11 inch and the width is .32 inch. The "-S-" indicates a soft gasket. The "SN" indicates a bright tin finish. See list below for available finishes. This part is available in lengths of 16 inches. Consult factory for custom lengths or for availability in 25' coils.

Available Plating Finishes:		
Finish Type	Applicable Specifications	Leader Tech Finish Code
Bright Finish	-	BD
Bright Tin	ASTM B-545, CLASS A	SN
Satin/Matte Tin	ASTM B-545, CLASS A	ST
Tin Lead	ASTM B-579, SC2	SNpb
Electro-less Nickel RoHS	ASTM B-733, SC 1, CLASS 1	NI
Zinc/Chromate Clear	ASTM B-633, SC1, TYPE III	Zinc
Zinc/Chromate Yellow	ASTM B-633, SC1, TYPE II	ZincY
Clear Cadmium Chromate	ASTM B-766, CLASS 5, TYPE III	CDC
Yellow Cadmium Chromate	ASTM B-766, CLASS 5, TYPE II	CDY
Bright Silver	ASTM B-700, TYPE 2, GRADE B, CLASS N	AG
Satin/Matte Silver	ASTM B-700, TYPE 2, GRADE A, CLASS N	MAG
Gold	ASTM B-488, TYPE I, CODE C, CLASS 1.25	AU
Solderable Unplated	-	SU

Standard plating finish is .0001 inch (.0025 mm) minimum. Plating processes and thicknesses may be varied to meet customer needs. Standard plating finish for gold is 0.00005 inches. See adjacent list of available finishes and consult factory for additional options.

ADHESIVE MOUNTING OF FINGERSTOCK GASKETS

Leader Tech tape mounted CuBe gaskets offer pressure-sensitive, double-sided adhesive for strong bonding to a wide variety of surface conditions. Ideal for all-purpose contact strips used in metal cabinets and electronic enclosures and is unaffected by temperatures from -67 to +250°F (-55 to 121°C)

Simply follow these four easy steps:

1. Remove all grease and oily residue with a solvent such as isopropyl alcohol/water mixture (rubbing alcohol) or heptane. Dry and smooth the mounting surface with emery cloth if necessary.
2. Peel off the protective paper backing from the pressure sensitive adhesive tape.
3. Place the gasket in correct position. Press firmly to ensure a good bond to surface. Avoid repositioning, which might impair the effectiveness of the adhesive or may bend or kink the strip. NOTE: On strips where fingers cover the solid portion of the gasket, pressure may be applied by inserting a mandrel in the strip and pressing down.
4. At room temperature approximately 50% of the ultimate strength will be achieved after 20 minutes, 90% after 24 hours, and 100% after 72 hours. In some cases, bond strength can be increased and ultimate bond strength can be achieved more quickly by exposure of the bond to elevated temperature, e.g., 150°F (66°C) for 1 hour.

METALS GALVANIC COMPATIBILITY CHART

Group Number	Metallurgical Category	Anodic Index (V)	Compatible Surface Finishes							
			Gold	Silver	Nickel	Be-Cu	Tin	Sn-Pb	Zinc	
1	Gold, solid and plated, Wrought platinum, graphite carbon	0.00	Harsh	Harsh	Harsh	Harsh	Harsh	Harsh	Harsh	Harsh
2		0.05	Harsh	Harsh	Harsh	Harsh	Harsh	Harsh	Harsh	Harsh
3	Rhodium plating	0.10	Harsh	Harsh	Harsh	Harsh	Harsh	Harsh	Harsh	Harsh
4	Silver, high-silver alloys	0.15	Harsh	Harsh	Harsh	Harsh	Harsh	Harsh	Harsh	Harsh
5		0.20	Harsh	Harsh	Harsh	Harsh	Harsh	Harsh	Harsh	Harsh
6		0.25	Harsh	Harsh	Harsh	Harsh	Harsh	Harsh	Harsh	Harsh
7	Nickel, nickel-copper alloys, titanium, titanium alloys, Monel	0.30	Harsh	Harsh	Harsh	Harsh	Harsh	Harsh	Harsh	Harsh
8	Beryllium Copper, low brasses or bronzes, silver solder, copper, Ni-Cr alloys, austenitic corrosion resistant steels, most chrome-moly steels, specialty high-temp stainless steels	0.35	Harsh	Harsh	Harsh	Harsh	Harsh	Harsh	Harsh	Harsh
9	Commercial yellow brasses and bronzes	0.40	Harsh	Harsh	Harsh	Harsh	Harsh	Harsh	Harsh	Harsh
10	High brasses and bronzes, naval brass, Muntz metal	0.45	Harsh	Harsh	Harsh	Harsh	Harsh	Harsh	Harsh	Harsh
11	18% Cr type corrosion resistant steels, common 300 series stainless steels	0.50	Harsh	Harsh	Harsh	Harsh	Harsh	Harsh	Harsh	Harsh
12		0.55	Harsh	Harsh	Harsh	Harsh	Harsh	Harsh	Harsh	Harsh
13	Chromium or tin plating; 12% Cr type corrosion resistant steels, most 400 series stainless steels, i.e., 410 and some cast stainless steels	0.60	Harsh	Harsh	Harsh	Harsh	Harsh	Harsh	Harsh	Harsh
14	Terreplate, tin-lead solder	0.65	Harsh	Harsh	Harsh	Harsh	Harsh	Harsh	Harsh	Harsh
15	Lead; high-lead alloys	0.70	Harsh	Harsh	Harsh	Harsh	Harsh	Harsh	Harsh	Harsh
16	Wrought 2000 series aluminum alloys	0.75	Harsh	Harsh	Harsh	Harsh	Harsh	Harsh	Harsh	Harsh
17		0.80	Harsh	Harsh	Harsh	Harsh	Harsh	Harsh	Harsh	Harsh
18	Wrought aluminum alloys except 2000 series cast Al-Si alloys, 6000 series aluminum	0.85	Harsh	Harsh	Harsh	Harsh	Harsh	Harsh	Harsh	Harsh
19		0.90	Harsh	Harsh	Harsh	Harsh	Harsh	Harsh	Harsh	Harsh
20	Cast aluminum alloys other than Al-Si; cadmium plating	0.95	Harsh	Harsh	Harsh	Harsh	Harsh	Harsh	Harsh	Harsh
21		1.00	Harsh	Harsh	Harsh	Harsh	Harsh	Harsh	Harsh	Harsh
22		1.05	Harsh	Harsh	Harsh	Harsh	Harsh	Harsh	Harsh	Harsh
23		1.10	Harsh	Harsh	Harsh	Harsh	Harsh	Harsh	Harsh	Harsh
24		1.15	Harsh	Harsh	Harsh	Harsh	Harsh	Harsh	Harsh	Harsh
25	Hot Dipped galvanized or electrogalvanized steel	1.20	Harsh	Harsh	Harsh	Harsh	Harsh	Harsh	Harsh	Harsh
26	Wrought zinc; zinc die cast alloys	1.25	Harsh	Harsh	Harsh	Harsh	Harsh	Harsh	Harsh	Harsh
27		1.30	Harsh	Harsh	Harsh	Harsh	Harsh	Harsh	Harsh	Harsh
28		1.35	Harsh	Harsh	Harsh	Harsh	Harsh	Harsh	Harsh	Harsh
29		1.40	Harsh	Harsh	Harsh	Harsh	Harsh	Harsh	Harsh	Harsh
30		1.45	Harsh	Harsh	Harsh	Harsh	Harsh	Harsh	Harsh	Harsh
31		1.50	Harsh	Harsh	Harsh	Harsh	Harsh	Harsh	Harsh	Harsh
32		1.55	Harsh	Harsh	Harsh	Harsh	Harsh	Harsh	Harsh	Harsh
33		1.60	Harsh	Harsh	Harsh	Harsh	Harsh	Harsh	Harsh	Harsh
34		1.65	Harsh	Harsh	Harsh	Harsh	Harsh	Harsh	Harsh	Harsh
35		1.70	Harsh	Harsh	Harsh	Harsh	Harsh	Harsh	Harsh	Harsh
36	Wrought and cast magnesium alloys	1.75	Harsh	Harsh	Harsh	Harsh	Harsh	Harsh	Harsh	Harsh
37		1.80	Harsh	Harsh	Harsh	Harsh	Harsh	Harsh	Harsh	Harsh
38	Beryllium	1.85	Harsh	Harsh	Harsh	Harsh	Harsh	Harsh	Harsh	Harsh

*Harsh Environment .10 volts Max ■ *Normal Environment .25 volts Max. ■ *Office Environment .50 volts Max ■

LOW PROFILE SERIES

LPAH Low Profile Adhesive Mount														Black = inches Blue = mm	
PART NUMBER	A		B		FINGER		PITCH		MAT. THICK		LENGTH		FINGERS	TAPE	
8-45LPAH-XX-16	0.08	2.03	0.45	11.43	0.100	2.54	0.125	3.18	0.004	0.102	16	406	128	0.145	
8-S-45LPAH-XX-16	0.08	2.03	0.45	11.43	0.100	2.54	0.125	3.18	0.003	0.076	16	406	128	0.145	
12-60LPAH-XX-16	0.12	3.05	0.60	15.24	0.100	2.54	0.125	3.18	0.004	0.102	16	406	128	0.200	
12-S-60LPAH-XX-16	0.12	3.05	0.60	15.24	0.100	2.54	0.125	3.18	0.003	0.076	16	406	128	0.200	



MOUNTING
OPTIONS
Tape

The low profile series gaskets incorporate design features that allow for some of the lowest compression forces in the industry, while achieving high performance shielding effectiveness. These gaskets are ideally suited for small aperture applications.

XX - Select material/finish (see page 6)

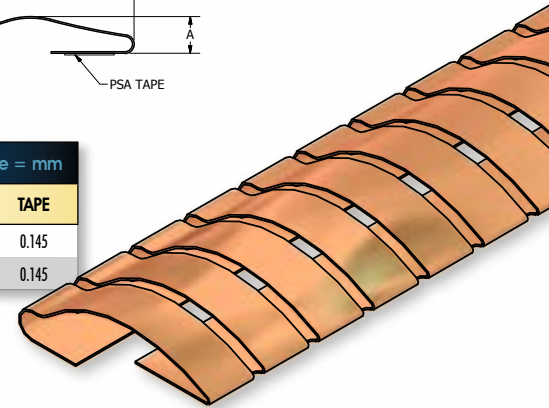
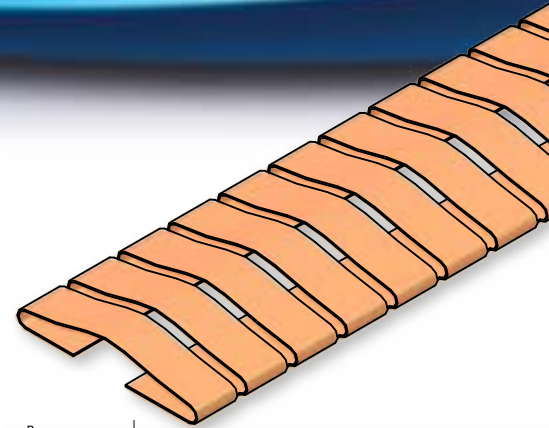
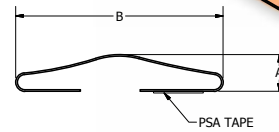

LPH Low Profile Hook														Black = inches Blue = mm	
PART NUMBER	A		B		FINGER		PITCH		MAT. THICK		LENGTH		HOOK ID	TAPE	
6-45LPH-060-XX-16	0.06	1.52	0.45	11.43	0.100	2.54	0.125	3.18	0.004	0.102	16	406	128	0.060	0.145
6-S-45LPH-060-XX-16	0.06	1.52	0.45	11.43	0.100	2.54	0.125	3.18	0.003	0.076	16	406	128	0.060	0.145



MOUNTING
OPTIONS
Tape

XX - Select material/finish (see page 6)



PCI SERIES

High performance Compact PCI Gaskets designed for easy card insertion in rack mount applications. This gasket is available in two different sizes to accommodate different customer extrusions. They are available in both Copper Beryllium and Stainless Steel.

PCI Contact																Black = inches Blue = mm	
PART NUMBER	A		B		C		D		FINGER		PITCH		MAT. THICK		LENGTH	FINGERS	
7-19PCI-XX-4.6	0.07	1.78	0.18	4.57	0.05	1.27	0.01	0.25	0.180	4.57	0.200	5.08	0.002	0.051	4.60	117	23
7-19PCI-XX-9.0	0.07	1.78	0.18	4.57	0.05	1.27	0.01	0.25	0.180	4.57	0.200	5.08	0.002	0.051	9.00	229	45
7-19PCI-XX-14.4	0.07	1.78	0.18	4.57	0.05	1.27	0.01	0.25	0.180	4.57	0.200	5.08	0.002	0.051	14.40	366	72
7-19PCI-SS-4.6	0.07	1.78	0.18	4.57	0.05	1.27	0.01	0.25	0.180	4.57	0.200	5.08	0.002	0.051	4.60	117	23
7-19PCI-SS-9.0	0.07	1.78	0.18	4.57	0.05	1.27	0.01	0.25	0.180	4.57	0.200	5.08	0.002	0.051	9.00	229	45
7-19PCI-SS-14.4	0.07	1.78	0.18	4.57	0.05	1.27	0.01	0.25	0.180	4.57	0.200	5.08	0.002	0.051	14.40	366	72
8-19PCI-XX-4.6	0.07	1.78	0.19	4.83	0.05	1.27	0.02	0.51	0.180	4.57	0.200	5.08	0.002	0.051	4.60	117	23
8-19PCI-XX-9.0	0.07	1.78	0.19	4.83	0.05	1.27	0.02	0.51	0.180	4.57	0.200	5.08	0.002	0.051	9.00	229	45
8-19PCI-XX-14.4	0.07	1.78	0.19	4.83	0.05	1.27	0.02	0.51	0.180	4.57	0.200	5.08	0.002	0.051	14.40	366	72
8-19PCI-SS-4.6	0.07	1.78	0.19	4.83	0.05	1.27	0.02	0.51	0.180	4.57	0.200	5.08	0.002	0.051	4.60	117	23
8-19PCI-SS-9.0	0.07	1.78	0.19	4.83	0.05	1.27	0.02	0.51	0.180	4.57	0.200	5.08	0.002	0.051	9.00	229	45
8-19PCI-SS-14.4	0.07	1.78	0.19	4.83	0.05	1.27	0.02	0.51	0.180	4.57	0.200	5.08	0.002	0.051	14.40	366	72



MOUNTING
OPTIONS
Extrusion

XX - Select material/finish (see page 6)

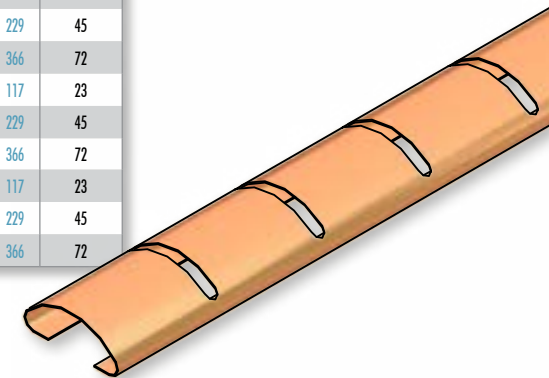

ADHESIVE MOUNT SERIES

AH Adhesive Mount		Black = inches Blue = mm Comp = Compressed																		
PART NUMBER	A		B		C		FINGER		PITCH		MAT. THICK		COMP WIDTH		COMP HEIGHT		LENGTH		FINGERS	TAPE
11-32AH-XX-16	0.11	2.79	0.32	8.13	0.20	5.08	0.170	4.32	0.187	4.75	0.003	0.076	0.39	9.91	0.04	1.02	16	406	86	0.145
11-S-32AH-XX-16	0.11	2.79	0.32	8.13	0.20	5.08	0.170	4.32	0.187	4.75	0.002	0.051	0.39	9.91	0.04	1.02	16	406	86	0.145
13-37AH-XX-16	0.13	3.30	0.37	9.40	0.21	5.33	0.225	5.72	0.250	6.35	0.003	0.076	0.51	12.95	0.05	1.27	16	406	64	0.145
13-S-37AH-XX-16	0.13	3.30	0.37	9.40	0.21	5.33	0.225	5.72	0.250	6.35	0.002	0.051	0.51	12.95	0.05	1.27	16	406	64	0.145
14-38AH-XX-16	0.14	3.56	0.38	9.65	0.20	5.08	0.343	8.71	0.375	9.53	0.004	0.102	0.53	13.46	0.05	1.27	16	406	43	0.145
22-60AH-XX-16	0.22	5.59	0.60	15.24	0.28	7.11	0.344	8.74	0.375	9.53	0.005	0.127	0.73	18.54	0.09	2.29	16	406	43	0.200
22-S-60AH-XX-16	0.22	5.59	0.60	15.24	0.28	7.11	0.344	8.74	0.375	9.53	0.003	0.076	0.73	18.54	0.09	2.29	16	406	43	0.200
32-78AH-XX-16	0.32	8.13	0.78	19.81	0.45	11.43	0.344	8.74	0.375	9.53	0.004	0.102	0.98	24.89	0.12	3.05	16	406	43	0.375
32-S-78AH-XX-16	0.32	8.13	0.78	19.81	0.45	11.43	0.344	8.74	0.375	9.53	0.003	0.076	0.98	24.89	0.12	3.05	16	406	43	0.375



MOUNTING
OPTIONS
Tape

The AH Series gaskets are adhesive mounted general-purpose gaskets used in both compression and wiping applications. Sizes range from .11" (2.8mm) to .32" (8.1mm) in height. Applications include electronic enclosures, shielded cabinets, and MRI chamber doors.

XX - Select material/finish (see page 6)



DOMESTOP SERIES

The Dome Top Gaskets are known for their large surface area for electrical contact and smooth wiping action. Also available in a solid top profile allowing for omni-directional wiping. Together with the Slot Mount Series, the Dome Top Gaskets are a mainstay in the enclosure/chassis industries. Commonly mounted with adhesive tape.

DT Dome Top		Black = inches Blue = mm Comp = Compressed																		
PART NUMBER	A		B		FINGER		PITCH		MAT. THICK		COMP WIDTH		COMP HEIGHT		LENGTH		FINGERS	TAPE		
11-35DT-XX-15	0.11	2.79	0.35	8.89	0.169	4.29	0.187	4.75	0.003	0.076	0.38	9.65	0.06	1.52	15	381	80	0.100		
11-S-35DT-XX-15	0.11	2.79	0.35	8.89	0.169	4.29	0.187	4.75	0.002	0.051	0.38	9.65	0.06	1.52	15	381	80	0.100		
14-45DT-XX-15	0.14	3.56	0.45	11.43	0.228	5.79	0.250	6.35	0.003	0.076	0.51	12.95	0.07	1.78	15	381	60	0.100		
14-S-45DT-XX-15	0.14	3.56	0.45	11.43	0.228	5.79	0.250	6.35	0.002	0.051	0.51	12.95	0.07	1.78	15	381	60	0.100		
22-62DT-XX-15	0.22	5.59	0.62	15.75	0.345	8.76	0.375	9.53	0.004	0.102	0.76	19.30	0.10	2.54	15	381	40	0.200		
22-S-62DT-XX-15	0.22	5.59	0.62	15.75	0.345	8.76	0.375	9.53	0.003	0.076	0.76	19.30	0.10	2.54	15	381	40	0.200		



MOUNTING
OPTIONS
Tape

The Dome Top gaskets have fully independent fingers that are adhesive mounted. Their smooth curve provides a large area for electrical contact and smooth wiping action.

XX - Select material/finish (see page 6)

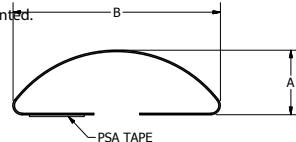

DTS Dome Top Solid		Black = inches Blue = mm Comp = Compressed																		
PART NUMBER	A		B		FINGER		PITCH		MAT. THICK		COMP WIDTH		COMP HEIGHT		LENGTH		FINGERS	TAPE		
11-35DTS-XX-15	0.11	2.79	0.35	8.89	0.169	4.29	0.187	4.75	0.003	0.076	0.38	9.65	0.06	1.52	15	381	80	0.100		
11-S-35DTS-XX-15	0.11	2.79	0.35	8.89	0.169	4.29	0.187	4.75	0.002	0.051	0.38	9.65	0.06	1.52	15	381	80	0.100		
14-45DTS-XX-15	0.14	3.56	0.45	11.43	0.250	6.35	0.250	6.35	0.003	0.076	0.51	12.95	0.07	1.78	15	381	60	0.100		
14-S-45DTS-XX-15	0.14	3.56	0.45	11.43	0.250	6.35	0.250	6.35	0.002	0.051	0.51	12.95	0.07	1.78	15	381	60	0.100		
22-62DTS-XX-15	0.22	5.59	0.62	15.75	0.345	8.76	0.375	9.53	0.004	0.102	0.76	19.30	0.10	2.54	15	381	40	0.200		
22-S-62DTS-XX-15	0.22	5.59	0.62	15.75	0.345	8.76	0.375	9.53	0.003	0.076	0.76	19.30	0.10	2.54	15	381	40	0.200		



MOUNTING
OPTIONS
Tape

The Dome Top "Solid" Series gaskets have a strip that connects each finger along the top. This allows for unique angular wiping action without snagging. Other features are the same as the Dome Top Series.

XX - Select material/finish (see page 6)



SLOT MOUNT SERIES

Slot mount gaskets are a standard in the electronic enclosure industry. These gaskets are used in shorter lengths as ESD contacts and longer lengths as EMI gaskets, which clip into slots or slide onto mounted tracks.

AF Alternate Finger Slot Mount															Black = inches Blue = mm								
PART NUMBER	A		B		C		D		*E Recommended		*F Recommended		*G Recommended		FINGER	PITCH		MAT. THICK		LENGTH		FINGERS	
11-32AF-XX-16	0.11	2.79	0.32	8.13	0.08	2.03	0.02	0.51	0.09	2.29	0.26	6.60	0.04	1.02	0.169	4.29	0.187	4.75	0.004	0.102	16	406	85
11-32AF3-XX-16	0.11	2.79	0.32	8.13	0.08	2.03	0.02	0.51	0.09	2.29	0.26	6.60	0.04	1.02	0.169	4.29	0.187	4.75	0.004	0.102	16	406	85
11-32AF4-XX-16	0.11	2.79	0.32	8.13	0.08	2.03	0.02	0.51	0.09	2.29	0.26	6.60	0.04	1.02	0.169	4.29	0.187	4.75	0.004	0.102	16	406	85
11-S-32AF-XX-16	0.11	2.79	0.32	8.13	0.08	2.03	0.02	0.51	0.09	2.29	0.26	6.60	0.04	1.02	0.169	4.29	0.187	4.75	0.002	0.051	16	406	85
11-S-32AF3-XX-16	0.11	2.79	0.32	8.13	0.08	2.03	0.02	0.51	0.09	2.29	0.26	6.60	0.04	1.02	0.169	4.29	0.187	4.75	0.002	0.051	16	406	85
11-S-32AF4-XX-16	0.11	2.79	0.32	8.13	0.08	2.03	0.02	0.51	0.09	2.29	0.26	6.60	0.04	1.02	0.169	4.29	0.187	4.75	0.002	0.051	16	406	85
22-60AF-XX-16	0.22	5.59	0.60	15.24	0.14	3.56	0.04	1.02	0.14	3.56	0.52	13.21	0.07	1.78	0.250	6.35	0.282	7.16	0.005	0.127	16	406	57
22-60AF3-XX-16	0.22	5.59	0.60	15.24	0.14	3.56	0.04	1.02	0.14	3.56	0.52	13.21	0.07	1.78	0.250	6.35	0.282	7.16	0.005	0.127	16	406	58
22-S-60AF-XX-16	0.22	5.59	0.60	15.24	0.14	3.56	0.04	1.02	0.14	3.56	0.52	13.21	0.07	1.78	0.250	6.35	0.282	7.16	0.003	0.076	16	406	57
22-S-60AF3-XX-16	0.22	5.59	0.60	15.24	0.14	3.56	0.04	1.02	0.14	3.56	0.52	13.21	0.07	1.78	0.250	6.35	0.282	7.16	0.003	0.076	16	406	58



MOUNTING
OPTIONS
Slot

*May vary depending on application

XX - Select material/finish (see page 6)

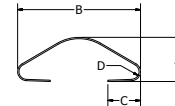

Alternate Finger Mounting Hole Recommendations



Variable Slot Mount Chart

A PATTERN PITCH FOR 11-32AF AND 11-S-32AF

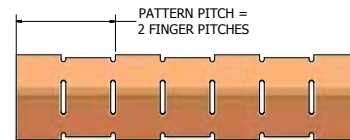

B PATTERN PITCH FOR 11-32AF3 AND 11-S-32AF3

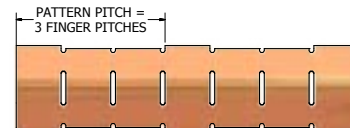

C PATTERN PITCH FOR 11-32AF4 AND 11-S-32AF4

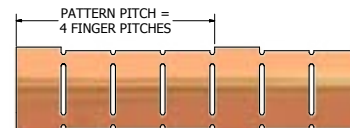

SLOT MOUNT SERIES CONT.

RH Slot Mount														Black = inches Blue = mm									
PART NUMBER	A		B		C		D		*N <small>Recommended</small>		*O <small>Recommended</small>		*P <small>Recommended</small>		FINGER	PITCH	MAT. THICK		LENGTH	FINGERS			
11-28RH-XX-16	0.11	2.79	0.28	7.11	0.08	2.03	0.02	0.51	0.09	2.29	0.22	5.59	0.04	1.02	0.169	4.29	0.187	4.75	0.003	0.076	16	406	86
11-S-28RH-XX-16	0.11	2.79	0.28	7.11	0.08	2.03	0.02	0.51	0.09	2.29	0.22	5.59	0.04	1.02	0.169	4.29	0.187	4.75	0.002	0.054	16	406	86
11-32RH-XX-16	0.11	2.79	0.32	8.13	0.09	2.29	0.02	0.51	0.09	2.29	0.26	6.60	0.04	1.02	0.169	4.29	0.187	4.75	0.003	0.076	16	406	86
11-S-32RH-XX-16	0.11	2.79	0.32	8.13	0.09	2.29	0.02	0.51	0.09	2.29	0.26	6.60	0.04	1.02	0.169	4.29	0.187	4.75	0.002	0.054	16	406	86
13-30RH-XX-16	0.13	3.30	0.30	7.62	0.09	2.29	0.03	0.76	0.09	2.29	0.25	6.35	0.05	1.27	0.169	4.29	0.187	4.75	0.004	0.102	16	406	86
13-37RH-XX-16	0.13	3.30	0.37	9.40	0.09	2.29	0.02	0.51	0.09	2.29	0.31	7.87	0.04	1.02	0.225	5.72	0.250	6.35	0.003	0.076	16	406	64
13-S-37RH-XX-16	0.13	3.30	0.37	9.40	0.09	2.29	0.02	0.51	0.09	2.29	0.31	7.87	0.04	1.02	0.225	5.72	0.250	6.35	0.002	0.054	16	406	64
22-60RH-XX-16	0.22	5.59	0.60	15.24	0.14	3.56	0.04	1.02	0.14	3.56	0.52	13.21	0.06	1.52	0.250	6.23	0.282	7.16	0.005	0.127	16	406	57
22-S-60RH-XX-16	0.22	5.59	0.60	15.24	0.14	3.56	0.04	1.02	0.14	3.56	0.52	13.21	0.06	1.52	0.250	6.35	0.282	7.16	0.003	0.076	16	406	57



MOUNTING
OPTIONS

*May vary depending on application

XX - Select material/finish (see page 6)



MOUNTING CONCEPTS

FOLDED SERIES

Leader Tech's Folded Gasket series are industry standard, general-purpose gaskets that allow a large range of deflection and compression forces. These gaskets are available with or without tape for alternate attachment methods. Also available in a snag-free version where, under compression, the leading edge of the gasket slides into an extended and folded base which prevents possible damage to the gasket.

FS Folded		Black = inches Blue = mm Comp = Compressed																		
PART NUMBER	A		B		C		FINGER		PITCH		MAT. THICK		COMP LENGTH		COMP HEIGHT		LENGTH		FINGERS	TAPE
11-28FS-XX-16	0.11	2.79	0.28	7.11	0.24	6.10	0.170	4.32	0.188	4.78	0.003	0.076	0.37	9.40	0.07	1.78	16	406	85	0.145
11-28FS-XX-300	0.11	2.79	0.28	7.11	0.24	6.10	0.170	4.32	0.188	4.78	0.003	0.076	0.37	9.40	0.07	1.78	300	7620	1596	0.145
11-S-28FS-XX-16	0.11	2.79	0.28	7.11	0.24	6.10	0.170	4.32	0.188	4.78	0.002	0.051	0.37	9.40	0.07	1.78	16	406	85	0.145
11-S-28FS-XX-300	0.11	2.79	0.28	7.11	0.24	6.10	0.170	4.32	0.188	4.78	0.002	0.051	0.37	9.40	0.07	1.78	300	7620	1596	0.145
14-37FS-XX-16	0.14	3.56	0.37	9.40	0.32	8.13	0.228	5.79	0.250	6.35	0.003	0.076	0.50	12.70	0.10	2.54	16	406	64	0.200
14-37FS-XX-300	0.14	3.56	0.37	9.40	0.32	8.13	0.228	5.79	0.250	6.35	0.003	0.076	0.50	12.70	0.10	2.54	300	7620	1200	0.200
14-S-37FS-XX-16	0.14	3.56	0.37	9.40	0.31	7.87	0.228	5.79	0.250	6.35	0.002	0.051	0.50	12.70	0.10	2.54	16	406	64	0.200
23-60FS-XX-24	0.23	5.84	0.60	15.24	0.50	12.70	0.343	8.71	0.375	9.53	0.004	0.102	0.77	19.56	0.12	3.05	24	610	64	0.250
23-60FS-XX-300	0.23	5.84	0.60	15.24	0.50	12.70	0.343	8.71	0.375	9.53	0.004	0.102	0.77	19.56	0.12	3.05	300	7620	800	0.250
25-78FS-XX-24	0.25	6.35	0.78	19.81	0.53	13.46	0.335	8.51	0.375	9.53	0.005	0.127	0.94	23.88	0.15	3.81	24	610	64	0.375
25-78FS-XX-300	0.25	6.35	0.78	19.81	0.53	13.46	0.340	8.64	0.375	9.53	0.005	0.127	0.94	23.88	0.15	3.81	300	7620	800	0.375
25-S-78FS-XX-24	0.25	6.35	0.78	19.81	0.53	13.46	0.335	8.51	0.375	9.53	0.003	0.076	0.94	23.88	0.15	3.81	24	610	64	0.375
25-S-78FS-XX-300	0.25	6.35	0.78	19.81	0.53	13.46	0.335	8.51	0.375	9.53	0.003	0.076	0.94	23.88	0.15	3.81	300	7620	800	0.375
41-113FS-XX-12	0.41	10.41	1.13	28.70	0.80	20.32	0.460	11.68	0.500	12.70	0.007	0.178	1.94	49.28	0.23	5.84	12	305	24	0.375



MOUNTING OPTIONS
Tape
Solder
Rivet

The Leader Tech FS gaskets are industry standard, general-purpose gaskets that allow a large range of deflection and compression forces. These gaskets are available without tape for alternate attachment methods. Consult factory for information.

XX - Select material/finish (see page 6)

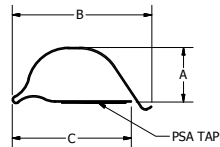

FSC Folded		Black = inches Blue = mm Comp = Compressed															
PART NUMBER	A		B		FINGER		PITCH		MAT. THICK		COMP HEIGHT		LENGTH		FINGERS		TAPE
8-25FSC-XX-16	0.08	2.03	0.25	6.35	0.170	4.32	0.188	4.78	0.003	0.076	0.048	1.22	16	406	85	0.145	
14-51FSC-XX-16	0.14	3.56	0.51	12.95	0.228	5.79	0.250	6.35	0.003	0.076	0.100	2.54	16	406	64	0.375	
14-S-51FSC-XX-16	0.14	3.56	0.51	12.95	0.228	5.79	0.250	6.35	0.002	0.051	0.100	2.54	16	406	64	0.375	
23-76FSC-XX-24	0.23	5.84	0.76	19.30	0.343	8.64	0.375	9.53	0.004	0.102	0.115	2.92	24	610	64	0.375	



MOUNTING OPTIONS
Tape
Solder
Rivet

The FSC was created to provide snag-free gaskets with FS gasket features. The base of the gasket is extended from the mounting area and then folded up, over, down, and then comes to rest over the leading edge of the formed spring. Under compression, the leading edge of the gasket slides under and is "captured." This "no snag" feature is also used to prevent possible gasket damage.

XX - Select material/finish (see page 6)



FOLDED SERIES CONT.

FSV Folded		Black = inches Blue = mm Comp = Compressed																					
PART NUMBER	A	B	C	D	E	FINGER		PITCH		MAT. THICK		COMP WIDTH		COMP HEIGHT		LENGTH		FINGERS					
11-28FSV23-XX-16	0.11	2.79	0.28	7.11	0.24	6.10	0.06	1.52	0.188	4.78	0.170	4.32	0.188	4.78	0.003	0.076	0.37	9.40	0.07	1.78	16	406	85
11-S-28FSV23-XX-16	0.11	2.79	0.28	7.11	0.24	6.10	0.06	1.52	0.188	4.78	0.170	4.32	0.188	4.78	0.002	0.051	0.37	9.40	0.07	1.78	16	406	85
14-37FSV30-XX-16	0.14	3.66	0.37	9.40	0.32	8.13	0.06	1.52	0.250	6.35	0.228	5.79	0.250	6.35	0.003	0.076	0.50	12.70	0.10	2.54	16	406	64
14-S-37FSV30-XX-16	0.14	3.66	0.37	9.40	0.32	8.13	0.06	1.52	0.250	6.35	0.228	5.79	0.250	6.35	0.002	0.051	0.50	12.70	0.10	2.54	16	406	64
23-60FSV50-XX-24	0.23	5.84	0.60	15.24	0.50	12.70	0.08	2.03	0.375	9.53	0.343	8.71	0.375	9.50	0.004	0.102	0.77	19.56	0.12	3.05	24	610	64
25-78FSV50-XX-24	0.25	6.35	0.78	19.81	0.50	12.70	0.14	3.56	0.375	9.53	0.335	8.51	0.375	9.50	0.005	0.127	0.94	23.88	0.15	3.81	24	610	64
25-S-78FSV50-XX-24	0.25	6.35	0.78	19.81	0.50	12.70	0.14	3.56	0.375	9.53	0.335	8.51	0.375	9.50	0.003	0.076	0.94	23.88	0.15	3.81	24	610	64
41-113FSV-XX-12	0.41	10.41	1.13	28.70	0.80	20.32	0.14	3.56	0.500	12.70	0.460	11.68	0.500	12.70	0.007	0.178	1.94	49.28	0.23	5.84	12	305	24



MOUNTING OPTIONS
Tape
Rivet
Solder

The FSV is an FS gasket that has the base bent at a right angle to the curve of the spring form, with all the other features of the FS gasket maintained. Tape optional - please consult factory.

XX - Select material/finish (see page 6)



FSDS Folded		Black = inches Blue = mm Comp = Compressed																					
PART NUMBER	A	B	C	D	E	FINGER		PITCH		COMP WIDTH		COMP HEIGHT		MATERIAL THICK		LENGTH		FINGERS					
25-109FSDS-XX-24	0.25	6.35	1.09	27.69	0.16	4.06	0.14	3.56	0.38	9.65	0.335	8.51	0.375	9.53	1.27	32.26	0.15	3.81	0.005	0.127	24	610	64
25-109FSDS-XX-300	0.25	6.35	1.09	27.69	0.16	4.06	0.14	3.56	0.38	9.65	0.335	8.51	0.375	9.53	1.27	32.26	0.15	3.81	0.005	0.127	300	7620	800
25-S-109FSDS-XX-24	0.25	6.35	1.09	27.69	0.16	4.06	0.14	3.56	0.38	9.65	0.335	8.51	0.375	9.53	1.27	32.26	0.15	3.81	0.003	0.076	24	610	64
25-S-109FSDS-XX-300	0.25	6.35	1.09	27.69	0.16	4.06	0.14	3.56	0.38	9.65	0.335	8.51	0.375	9.53	1.27	32.26	0.15	3.81	0.003	0.076	300	7620	800
41-163FSDS-XX-24	0.41	10.41	1.63	41.40	0.19	4.83	0.14	3.56	0.50	12.70	0.460	11.68	0.500	12.70	1.90	48.26	0.23	5.84	0.007	0.178	24	610	48
41-163FSDS-XX-300	0.41	10.41	1.63	41.40	0.19	4.83	0.14	3.56	0.50	12.70	0.460	11.68	0.500	12.70	1.90	48.26	0.23	5.84	0.007	0.178	300	7620	600



MOUNTING OPTIONS
Tape
Rivet
Solder

The FSDS is an FS gasket with its base lying on the same plane as the curve in the spring form, with the mounting area shortened. This mounting is often modified for custom applications.

XX - Select material/finish (see page 6)

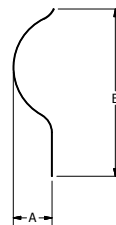

TWIST SERIES

The Twist series gaskets are designed for demanding compression applications. This series can compress to material thickness and provide excellent shielding performance. Profiles include standard flat, right angle, double twist, and clip-on.

T Twist		Black = inches Blue = mm Comp = Compressed														
PART NUMBER	A		B		C		FINGER		PITCH		MATERIAL THICK		LENGTH		FINGERS	TAPE
3-20T-XX-24	0.03	0.76	0.20	5.08	0.11	2.79	0.080	2.03	0.095	2.41	0.003	0.076	24	610	253	0.100
3-20T-XX-300	0.03	0.76	0.20	5.08	0.11	2.79	0.080	2.03	0.095	2.41	0.003	0.076	300	7620	3158	0.100
3-23T-XX-24	0.03	0.76	0.23	5.84	0.14	3.56	0.080	2.03	0.095	2.41	0.003	0.076	24	610	253	0.100
3-23T-XX-300	0.03	0.76	0.23	5.84	0.14	3.56	0.080	2.03	0.095	2.41	0.003	0.076	300	7620	3158	0.100
3-S-23T-XX-24	0.03	0.76	0.23	5.84	0.14	3.56	0.080	2.03	0.095	2.41	0.002	0.051	24	610	253	0.100
3-S-23T-XX-300	0.03	0.76	0.23	5.84	0.14	3.56	0.080	2.03	0.095	2.41	0.002	0.051	300	7620	3158	0.100
6-30T-XX-24	0.07	1.78	0.30	7.62	0.15	3.81	0.150	3.81	0.165	4.19	0.003	0.076	24	610	146	0.100
6-30T-XX-300	0.07	1.78	0.30	7.62	0.15	3.81	0.150	3.81	0.165	4.19	0.003	0.076	300	7620	1818	0.100
6-S-30T-XX-24	0.07	1.78	0.30	7.62	0.15	3.81	0.150	3.81	0.165	4.19	0.002	0.051	24	610	146	0.145
6-S-30T-XX-300	0.07	1.78	0.30	7.62	0.15	3.81	0.150	3.81	0.165	4.19	0.002	0.051	300	7620	1818	0.145
6-34T-XX-24	0.07	1.78	0.34	8.64	0.18	4.57	0.150	3.81	0.165	4.19	0.003	0.076	24	610	146	0.145
6-34T-XX-300	0.07	1.78	0.34	8.64	0.18	4.57	0.150	3.81	0.165	4.19	0.003	0.076	300	7620	1818	0.145
6-S-34T-XX-24	0.07	1.78	0.34	8.64	0.18	4.57	0.150	3.81	0.165	4.19	0.002	0.051	24	610	146	0.145
6-S-34T-XX-300	0.07	1.78	0.34	8.64	0.18	4.57	0.150	3.81	0.165	4.19	0.002	0.051	300	7620	1818	0.145



MOUNTING OPTIONS
Tape
Solder

XX - Select material/finish (see page 6)



TV Twist		Black = inches Blue = mm														
PART NUMBER	A		B		C		FINGER		PITCH		MATERIAL THICK		LENGTH		FINGERS	TAPE
3-23TV-XX-24	0.03	0.76	0.08	2.03	0.16	4.06	0.080	2.03	0.095	2.41	0.003	0.076	24	610	253	0.100
3-23TV-XX-30	0.03	0.76	0.08	2.03	0.16	4.06	0.080	2.03	0.095	2.41	0.003	0.076	300	7620	3158	0.100
3-23TV30-XX-24	0.03	0.76	0.08	2.03	0.30	7.62	0.080	2.03	0.095	2.41	0.003	0.076	24	610	253	0.250
3-S-23TV-XX-24	0.03	0.76	0.08	2.03	0.16	4.06	0.080	2.03	0.095	2.41	0.002	0.051	24	610	253	0.100
3-S-23TV30-XX-300	0.03	0.76	0.08	2.03	0.30	7.62	0.080	2.03	0.095	2.41	0.002	0.051	300	7620	3158	0.250
6-34TV-XX-24	0.07	1.78	0.14	3.56	0.20	5.08	0.150	3.81	0.165	4.19	0.003	0.076	24	610	146	0.145
6-34TV-XX-300	0.07	1.78	0.14	3.56	0.20	5.08	0.150	3.81	0.165	4.19	0.003	0.076	300	7620	1818	0.145
6-S-34TV-XX-24	0.07	1.78	0.14	3.56	0.20	5.08	0.150	3.81	0.165	4.19	0.002	0.051	24	610	146	0.145
6-S-34TV-XX-300	0.07	1.78	0.14	3.56	0.20	5.08	0.150	3.81	0.165	4.19	0.002	0.051	300	7620	1818	0.145



MOUNTING OPTIONS
Tape
Solder

XX - Select material/finish (see page 6)



TWIST SERIES CONT.

T2 Twist		Black = inches Blue = mm														
PART NUMBER	A		B		C		FINGER		PITCH		MATERIAL THICK		LENGTH		FINGERS	TAPE
6-50T2-XX-24	0.07	1.78	0.50	12.70	0.18	4.57	0.150	3.81	0.165	4.19	0.003	0.076	24	610	146	0.145
6-50T2-XX-300	0.07	1.78	0.50	12.70	0.18	4.57	0.150	3.81	0.165	4.19	0.003	0.076	300	7620	1818	0.145
6-S-50T2-XX-24	0.07	1.78	0.50	12.70	0.18	4.57	0.150	3.81	0.165	4.19	0.002	0.051	24	610	146	0.145
6-S-50T2-XX-300	0.07	1.78	0.50	12.70	0.18	4.57	0.150	3.81	0.165	4.19	0.002	0.051	300	7620	1818	0.145



MOUNTING OPTIONS
Tape

XX - Select material/finish (see page 6)



UT Twist		Black = inches Blue = mm															
PART NUMBER	A		B		FINGER		PITCH		MATERIAL THICK		LENGTH		FINGERS	CLIP ID	LANCE	LANCE PITCH	
3-23UT-040-XX-16	0.03	0.76	0.15	3.81	0.080	2.03	0.095	2.41	0.003	0.076	16	406	168	0.04	1.02	n/a	n/a
3-23UT-070-XX-16	0.03	0.76	0.15	3.81	0.080	2.03	0.095	2.41	0.003	0.076	16	406	168	0.07	1.78	n/a	n/a
3-23UT-070-DL-XX-16	0.03	0.76	0.15	3.81	0.080	2.03	0.095	2.41	0.003	0.076	16	406	168	0.07	1.78	D	1"
6-34UT-040-XX-16	0.07	1.78	0.22	5.59	0.150	3.81	0.165	4.19	0.003	0.076	16	406	97	0.04	1.02	n/a	n/a
6-34UT-070-XX-16	0.07	1.78	0.22	5.59	0.150	3.81	0.165	4.19	0.003	0.076	16	406	97	0.07	1.78	n/a	n/a
6-34UT-070-DL-XX-16	0.07	1.78	0.22	5.59	0.150	3.81	0.165	4.19	0.003	0.076	16	406	97	0.07	1.78	D	1"



MOUNTING OPTIONS
Clip

XX - Select material/finish (see page 6)



UT3 Twist		Black = inches Blue = mm																	
PART NUMBER	A		B		C		FINGER		PITCH		MATERIAL THICK		LENGTH		FINGERS	CLIP ID	LANCE	LANCE PITCH	
6-34UT3-050-XX-16	0.07	1.78	0.38	9.65	0.22	5.59	0.150	3.81	0.165	4.19	0.003	0.076	16	406	97	0.05	1.27	n/a	n/a
6-34UT3-050-DL-XX-16	0.07	1.78	0.38	9.65	0.22	5.59	0.150	3.81	0.165	4.19	0.003	0.076	16	406	97	0.05	1.27	D	1"
6-34UT3-070-XX-16	0.07	1.78	0.38	9.65	0.22	5.59	0.150	3.81	0.165	4.19	0.003	0.076	16	406	97	0.07	1.78	n/a	n/a
6-34UT3-070-DL-XX-16	0.07	1.78	0.38	9.65	0.22	5.59	0.150	3.81	0.165	4.19	0.003	0.076	16	406	97	0.07	1.78	D	1"



MOUNTING OPTIONS
Clip

XX - Select material/finish (see page 6)

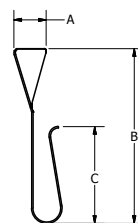

CLIP-ON SERIES

The Clip-On Gaskets are used in enclosures, shielded cabinets, and on circuit cards as ESD contacts and EMI gaskets. For edge mount applications, close attention must be given to clip size, lance requirements, deflection parameters and finger configuration. Leader Tech provides application assistance in the development of specifications.

C Clip-On		Black = inches Blue = mm Comp = Compressed																				
PART NUMBER	A		B		C		FINGER		PITCH		MATERIAL THICK		COMP WIDTH		COMP HEIGHT		LANCE START		LANCE PITCH		FINGERS	LANCE
10-30CD-XX-16	0.10	2.54	0.30	7.62	0.07	1.78	0.135	3.43	0.182	4.62	0.005	0.127	0.33	8.38	0.05	1.27	0.341	8.66	0.728	18.49	88	D
10-30CT-XX-16	0.10	2.54	0.30	7.62	0.07	1.78	0.135	3.43	0.182	4.62	0.005	0.127	0.33	8.38	0.05	1.27	0.341	8.66	0.728	18.49	88	T
11-45CD-XX-16	0.11	2.79	0.45	11.43	0.07	1.78	0.147	3.73	0.193	4.90	0.005	0.127	0.47	11.94	0.06	1.52	0.267	6.78	0.748	19.00	84	D
11-45CT-XX-16	0.11	2.79	0.45	11.43	0.07	1.78	0.147	3.73	0.193	4.90	0.005	0.127	0.47	11.94	0.06	1.52	0.651	16.54	1.352	34.34	84	T



Clip

XX - Select material/finish (see page 6)

10-30CD

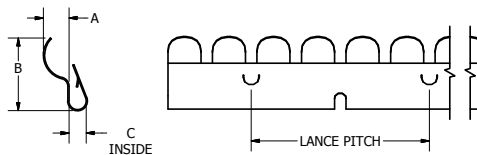
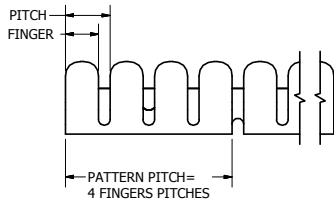

10-30CT

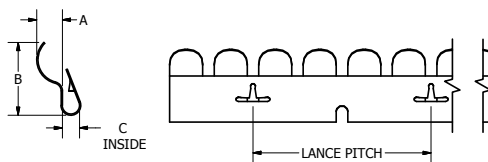
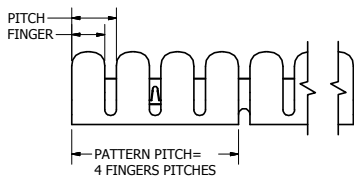

11-45CD

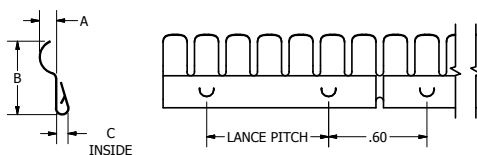
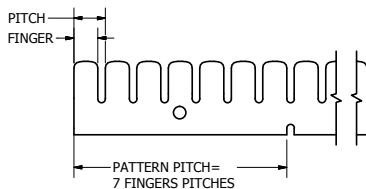

11-45CT

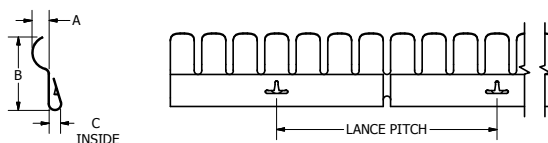
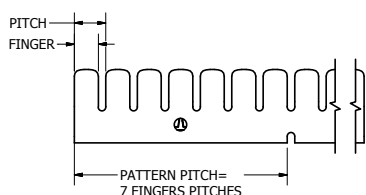

CLIP-ON SERIES CONT.

C Mini-Clip																			Black = inches Blue = mm		
PART NUMBER	A		B		C		FINGER		PITCH		MATERIAL THICK		LANCE START		LANCE PITCH		LENGTH	FINGERS	CLIP ID	LANCE	
7-21C-045-DL-XX-16	0.07	1.78	0.25	6.35	0.03	0.76	0.170	4.32	0.200	5.08	0.003	0.076	0.49	12.45	1.00	25.40	16	406	80	0.045	D



Clip

XX - Select material/finish (see page 6)

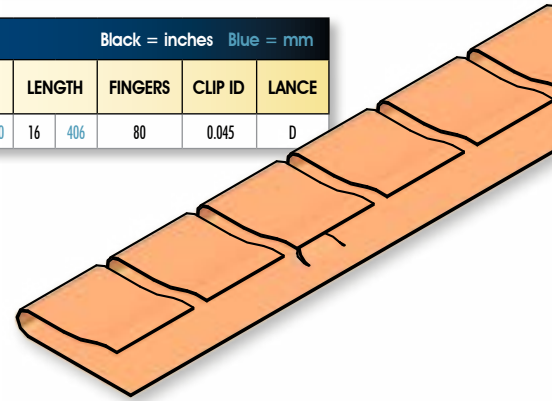
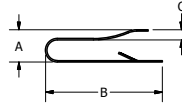

C Clip-On																			Black = inches Blue = mm Comp = Compressed			
PART NUMBER	A		B		C		FINGER		PITCH		MATERIAL THICK		COMP WIDTH	COMP HEIGHT	LANCE START	LANCE PITCH	FINGERS	LANCE				
10-30C-045-XX-16	0.10	2.54	0.30	7.62	0.045	1.14	0.140	3.56	0.187	4.75	0.005	0.127	0.33	8.38	0.05	1.27	-	-	-	-	86	n/a
10-30C-050-XX-16	0.10	2.54	0.30	7.62	0.050	1.27	0.140	3.56	0.187	4.75	0.005	0.127	0.33	8.38	0.05	1.27	-	-	-	-	86	n/a
10-30C-065-XX-16	0.10	2.54	0.30	7.62	0.065	1.65	0.140	3.56	0.187	4.75	0.005	0.127	0.33	8.38	0.05	1.27	-	-	-	-	86	n/a
10-30C-070-XX-16	0.10	2.54	0.30	7.62	0.070	1.78	0.140	3.56	0.187	4.75	0.005	0.127	0.33	8.38	0.05	1.27	-	-	-	-	86	n/a
10-30C-045-DL-XX-16	0.10	2.54	0.30	7.62	0.045	1.14	0.140	3.56	0.187	4.75	0.005	0.127	0.33	8.38	0.05	1.27	0.5	12.7	1	25.4	86	D
10-30C-050-DL-XX-16	0.10	2.54	0.30	7.62	0.050	1.27	0.140	3.56	0.187	4.75	0.005	0.127	0.33	8.38	0.05	1.27	0.5	12.7	1	25.4	86	D
10-30C-065-DL-XX-16	0.10	2.54	0.30	7.62	0.065	1.65	0.140	3.56	0.187	4.75	0.005	0.127	0.33	8.38	0.05	1.27	0.5	12.7	1	25.4	86	D
10-30C-070-DL-XX-16	0.10	2.54	0.30	7.62	0.070	1.78	0.140	3.56	0.187	4.75	0.005	0.127	0.33	8.38	0.05	1.27	0.5	12.7	1	25.4	86	D
11-45C-045-XX-16	0.11	2.79	0.45	11.43	0.045	1.14	0.140	3.56	0.187	4.75	0.005	0.127	0.47	11.94	0.06	1.52	-	-	-	-	86	n/a
11-45C-050-XX-16	0.11	2.79	0.45	11.43	0.050	1.27	0.140	3.56	0.187	4.75	0.005	0.127	0.47	11.94	0.06	1.52	-	-	-	-	86	n/a
11-45C-065-XX-16	0.11	2.79	0.45	11.43	0.065	1.65	0.140	3.56	0.187	4.75	0.005	0.127	0.47	11.94	0.06	1.52	-	-	-	-	86	n/a
11-45C-070-XX-16	0.11	2.79	0.45	11.43	0.070	1.78	0.140	3.56	0.187	4.75	0.005	0.127	0.47	11.94	0.06	1.52	-	-	-	-	86	n/a
11-45C-045-DL-XX-16	0.11	2.79	0.45	11.43	0.045	1.14	0.140	3.56	0.187	4.75	0.005	0.127	0.47	11.94	0.06	1.52	0.5	12.7	1	25.4	86	D
11-45C-050-DL-XX-16	0.11	2.79	0.45	11.43	0.050	1.27	0.140	3.56	0.187	4.75	0.005	0.127	0.47	11.94	0.06	1.52	0.5	12.7	1	25.4	86	D
11-45C-065-DL-XX-16	0.11	2.79	0.45	11.43	0.065	1.65	0.140	3.56	0.187	4.75	0.005	0.127	0.47	11.94	0.06	1.52	0.5	12.7	1	25.4	86	D
11-45C-070-DL-XX-16	0.11	2.79	0.45	11.43	0.070	1.78	0.140	3.56	0.187	4.75	0.005	0.127	0.47	11.94	0.06	1.52	0.5	12.7	1	25.4	86	D
25-109C-070-XX-16	0.25	6.35	1.09	27.69	0.070	1.78	0.340	8.64	0.375	9.53	0.005	0.127	1.27	32.26	0.08	2.03	-	-	-	-	43	n/a
25-109C-070-DL-XX-16	0.25	6.35	1.09	27.69	0.070	1.78	0.340	8.64	0.375	9.53	0.005	0.127	1.27	32.26	0.08	2.03	0.5	12.7	1	25.4	43	D
25-S-109C-070-XX-16	0.25	6.35	1.09	27.69	0.070	1.78	0.340	8.64	0.375	9.53	0.003	0.076	1.27	32.26	0.08	2.03	-	-	-	-	43	n/a
25-S-109C-070-DL-XX-16	0.25	6.35	1.09	27.69	0.070	1.78	0.340	8.64	0.375	9.53	0.003	0.076	1.27	32.26	0.08	2.03	0.5	12.7	1	25.4	43	D
25-109C-120-XX-16	0.25	6.35	1.09	27.69	0.120	3.05	0.340	8.64	0.375	9.53	0.005	0.127	1.27	32.26	0.08	2.03	-	-	-	-	43	n/a
25-109C-130-XX-16	0.25	6.35	1.09	27.69	0.130	3.30	0.340	8.64	0.375	9.53	0.005	0.127	1.27	32.26	0.08	2.03	-	-	-	-	43	n/a



Clip

Consult factory for optional clip sizes and optional lance features.

XX - Select material/finish (see page 6)

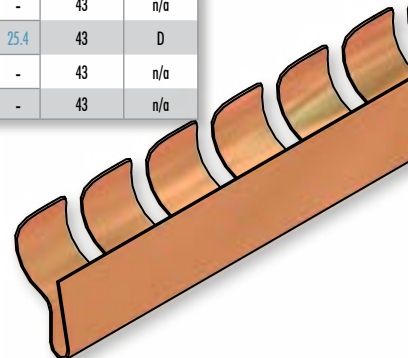
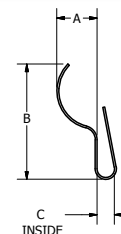

CLIP-ON SERIES CONT.

CPS Clip-On		Black = inches Blue = mm														
PART NUMBER	A		B		C		FINGER		PITCH		MATERIAL THICK		LENGTH		FINGERS/STRIP	LANCE
25-55CPS-XX-16	0.25	6.35	0.55	13.97	0.04	1.02	0.220	5.59	0.250	6.35	0.004	0.102	16	406	64	D

XX - Select material/finish (see page 6)

Perpendicular Shielding Gaskets

- Finger design allows for continuous contact across the length of the strip
- "D" lance provides superior retention of gasket to the mounting surface
- 0.80 D-clip is retained with .100 D-hole



CPG Clip-On		Black = inches Blue = mm														
PART NUMBER	A		B		C		FINGER		PITCH		MATERIAL THICK		LENGTH		FINGERS/STRIP	LANCE
6-31CPG-XX-12	0.06	1.52	0.31	7.87	0.04	1.02	0.500	12.70	0.545	13.84	0.004	0.102	12	305	22	D
6-31CPG-XX-16	0.06	1.52	0.31	7.87	0.04	1.02	0.500	12.70	0.545	13.84	0.004	0.102	16	406	29	D

XX - Select material/finish (see page 6)

Perpendicular Electrical Grounding Strips

- Finger extension provides grounding from card or PCB to a backplane housing surface
- Wide clip-on area with "D" lance offers reliable retention
- .0035 material offers significant resiliency



GROUNDING SERIES

ML Gasket		Black = inches Blue = mm													
PART NUMBER	A		B		C		FINGER		PITCH		MATERIAL THICK		LENGTH		FINGERS
14-18ML-XX-16	0.14	3.56	0.28	7.11	0.18	4.57	0.080	2.03	0.500	12.70	0.005	0.127	32		
14-18ML-XX-24	0.14	3.56	0.28	7.11	0.18	4.57	0.080	2.03	0.500	12.70	0.005	0.127	48		

XX - Select material/finish (see page 6)

MOUNTING OPTIONS

Tape

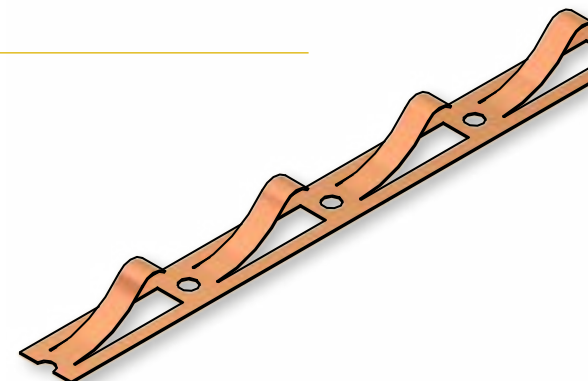

CONTACT SERIES

Contact gaskets are primarily used for grounding and shielding in high frequency applications. These gaskets provide engineers and designers with flexibility to solve their shielding and grounding issues. They are available in a variety of different lengths, widths and profiles. Standard factory length for Contact Series strips is 16". Individual contacts available in tape & reel packaging. Adhesive tape is optional - please consult factory.

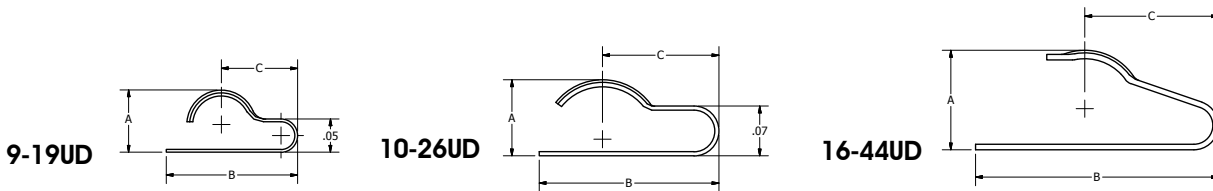

9-19UD 10-26UD 16-44UD Contact Series											Black = inches Blue = mm							
PART NUMBER	A		B		C		D		FINGER		PITCH		MAT. THICK		LENGTH	FINGERS/STRIP	TAPE	
9-19UD-XX-16	0.09	2.29	0.19	4.83	0.11	2.79	0.13	3.30	0.040	1.02	0.060	1.52	0.004	0.102	16	406	266	NO
10-26UD-XX-16	0.11	2.79	0.26	6.60	0.17	4.32	0.22	5.59	0.050	1.27	0.075	1.90	0.006	0.152	16	406	213	NO
16-44UD-XX-16	0.16	4.06	0.44	11.18	0.24	6.10	0.33	8.38	0.062	1.57	0.093	2.36	0.010	0.254	16	406	172	NO

XX - Select material/finish (see page 6)

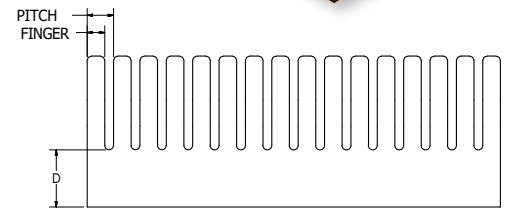

4-34D 4-38D 4-53D 9-78D 9-78D-A Contact Series											Black = inches Blue = mm							
PART NUMBER	A		B		C		D		FINGER		PITCH		MATERIAL THICK		LENGTH	FINGERS/STRIP	TAPE	
4-34D-XX-16	0.04	1.02	0.34	8.63	0.29	7.37	0.13	3.30	0.040	1.02	0.060	1.52	0.004	0.102	16	406	266	NO
4-38D-XX-16	0.05	1.27	0.38	9.65	0.31	7.87	0.062	15.75	0.050	1.27	0.075	1.90	0.006	0.152	16	406	213	NO
4-53D-XX-16	0.05	1.27	0.53	13.46	0.47	11.94	0.22	5.59	0.050	1.27	0.075	1.90	0.006	0.152	16	406	213	NO
9-78D-XX-16	0.05	1.27	0.78	19.81	0.66	16.76	0.31	7.87	0.062	1.57	0.093	2.36	0.010	0.254	16	406	172	NO
9-78D-A-XX-16	0.09	2.29	0.78	19.81	0.66	16.76	0.31	7.87	0.062	1.57	0.093	2.36	0.010	0.254	16	406	172	NO

XX - Select material/finish (see page 6)



CONTACT SERIES CONT.

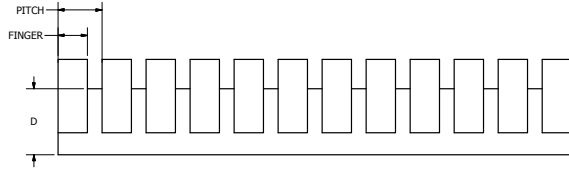

7-13U



13-28U*



7-13U 13-28U 28-49U Contact Series										Black = inches Blue = mm								
PART NUMBER	A		B		C		D		FINGER		PITCH		MAT. THICK		LENGTH		FINGERS/STRIP	TAPE
7-13U-XX-16	0.07	1.78	0.13	3.30	0.07	1.78	0.09	2.29	0.040	1.02	0.060	1.52	0.004	0.102	16	406	266	NO
13-28U-XX-16	0.13	3.30	0.28	7.11	0.16	4.06	0.23	5.84	0.095	2.41	0.135	3.43	0.010	0.254	16	406	118	NO
28-49U-XX-16	0.28	7.11	0.49	12.45	0.34	8.64	0.38	9.65	0.125	3.17	0.187	4.75	0.006	0.152	16	406	85	NO

XX - Select material/finish (see page 6)
 *Finger width starts at .095 and tapers to .092.

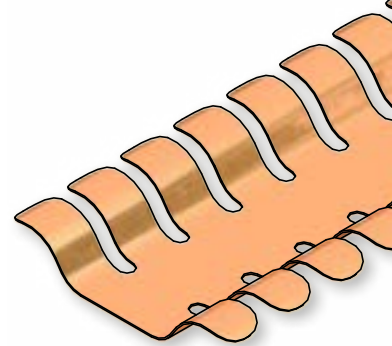
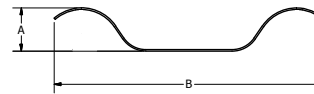
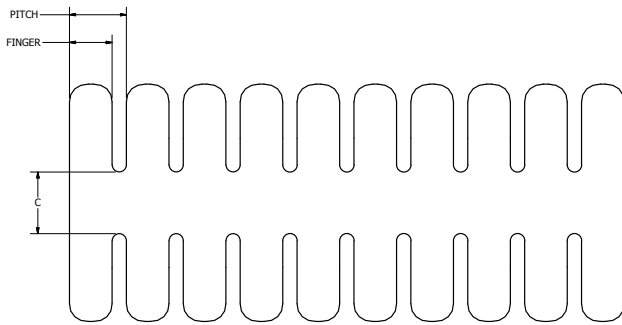

11-78R2 Contact Series										Black = inches Blue = mm							
PART NUMBER	A		B		C		FINGER		PITCH		MAT. THICK		LENGTH		FINGERS/STRIP	TAPE	
11-78R2-XX-16	0.13	3.30	0.78	19.81	0.20	5.08	0.140	3.56	0.187	4.75	0.005	0.127	16	406	86	NO	

XX - Select material/finish (see page 6)

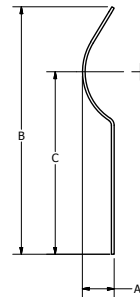

11-90S Contact Series										Black = inches Blue = mm							
PART NUMBER	A		B		C		D		FINGER		PITCH		MAT. THICK		LENGTH		FINGERS/STRIP
11-90S-XX-16	0.11	2.79	0.90	22.86	0.66	16.76	0.38	9.65	0.125	3.17	0.172	4.37	0.010	0.254	16	406	93

XX - Select material/finish (see page 6)

CONTACT SERIES CONT.



12-75RS | Contact Series Black = inches Blue = mm

PART NUMBER	A	B	C	D	FINGER	PITCH	MAT. THICK	LENGTH	FINGERS/STRIP	TAPE								
12-75RS-XX-16	0.12	3.05	0.75	19.05	0.12	3.05	0.65	16.51	0.140	3.56	0.187	4.75	0.005	0.127	16	406	85	YES

XX - Select material/finish (see page 6)

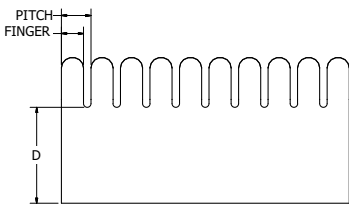
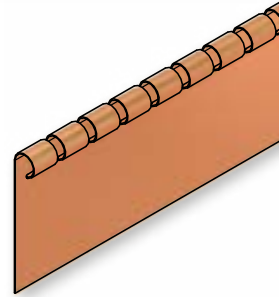
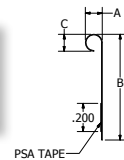

8-92RB | Contact Series Black = inches Blue = mm

PART NUMBER	A	B	C	D	FINGER	PITCH	MAT. THICK	LENGTH	FINGERS/STRIP	TAPE								
8-92RB-XX-16	0.09	2.29	0.92	23.37	0.30	7.62	0.61	15.49	0.140	3.56	0.187	4.75	0.005	0.127	16	406	85	NO

XX - Select material/finish (see page 6)

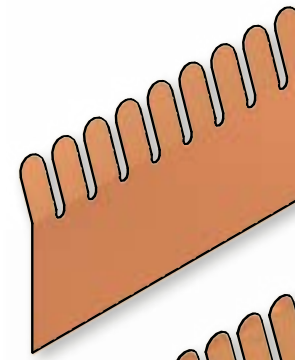
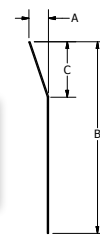

8-92RC | Contact Series Black = inches Blue = mm

PART NUMBER	A	B	C	D	FINGER	PITCH	MAT. THICK	LENGTH	FINGERS/STRIP	TAPE								
8-92RC-XX-16	0.09	2.29	0.92	23.37	0.30	7.62	0.63	16.00	0.140	3.56	0.187	4.75	0.005	0.127	16	406	85	NO

XX - Select material/finish (see page 6)

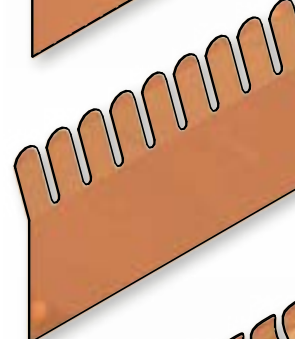
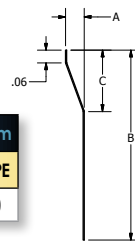

11-89RA | Contact Series Black = inches Blue = mm

PART NUMBER	A	B	C	D	FINGER	PITCH	MAT. THICK	LENGTH	FINGERS/STRIP	TAPE								
11-89RA-XX-16	0.13	3.30	0.89	22.61	0.81	20.57	0.60	15.24	0.140	3.56	0.187	4.75	0.005	0.127	16	406	85	NO

XX - Select material/finish (see page 6)

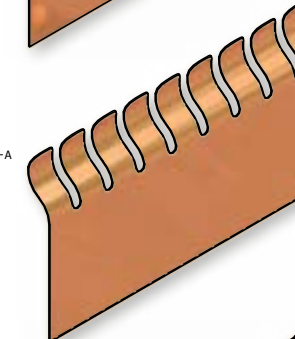
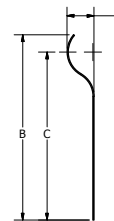

22-77RR | Contact Series Black = inches Blue = mm

PART NUMBER	A	B	C	D	FINGER	PITCH	MAT. THICK	LENGTH	FINGERS/STRIP	TAPE								
22-77RR-XX-16	0.23	5.84	0.77	19.56	0.64	16.26	0.62	15.75	0.140	3.56	0.187	4.75	0.005	0.127	16	406	85	NO

XX - Select material/finish (see page 6)

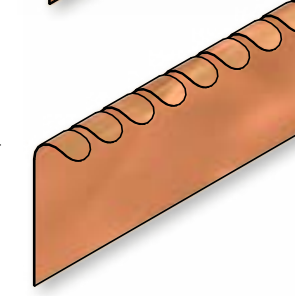
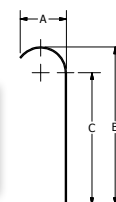

METAL D-SUBS



Standard Finish and Plating Options		
FINISH TYPE	SPECIFICATIONS	LEADER TECH FINISH CODE
BRIGHT FINISH	As Heat Treated	BD (Standard)
BRIGHT TIN	ASTM B-545	SN
SATIN TIN/MATTE TIN	ASTM B-545	ST
ELECTROLESS BRIGHT NICKEL ROHS	ASTM B 733	NI

D-Sub Miniature - Solid		Black = inches Blue = mm															
PART NUMBER	TYPE	A	B	C	D	E	F	G	H								
09D-110-XX	9 Pin	1.41	35.81	0.98	24.89	0.78	19.81	0.44	11.18	0.22	5.59	0.69	17.53	0.025	0.63	0.13	3.30
09D-100-SS	9 Pin	1.41	35.81	0.98	24.89	0.78	19.81	0.44	11.18	0.22	5.59	0.69	17.53	0.025	0.63	0.13	3.30
15D-110-XX	15 Pin	1.74	44.20	1.31	33.27	1.11	28.19	0.44	11.18	0.22	5.59	0.69	17.53	0.025	0.63	0.13	3.30
15D-100-SS	15 Pin	1.74	44.20	1.31	33.27	1.11	28.19	0.44	11.18	0.22	5.59	0.69	17.53	0.025	0.63	0.13	3.30
25D-110-XX	25 Pin	2.28	57.91	1.85	46.99	1.65	41.91	0.44	11.18	0.22	5.59	0.69	17.53	0.025	0.63	0.13	3.30
25D-100-SS	25 Pin	2.28	57.91	1.85	46.99	1.65	41.91	0.44	11.18	0.22	5.59	0.69	17.53	0.025	0.63	0.13	3.30
37D-110-XX	37 Pin	2.93	74.42	2.50	63.50	2.29	58.17	0.44	11.18	0.22	5.59	0.69	17.53	0.025	0.63	0.13	3.30
37D-100-SS	37 Pin	2.93	74.42	2.50	63.50	2.29	58.17	0.44	11.18	0.22	5.59	0.69	17.53	0.025	0.63	0.13	3.30
50D-110-XX	50 Pin	2.84	72.14	2.41	61.21	2.11	53.59	0.55	13.97	0.28	7.11	0.80	20.32	0.025	0.63	0.24	6.10
50D-100-SS	50 Pin	2.84	72.14	2.41	61.21	2.11	53.59	0.55	13.97	0.28	7.11	0.80	20.32	0.025	0.63	0.24	6.10

XX - Denotes the availability of finish/plating options. See chart above. Example: 09D-110-BD SS - Denotes stainless steel.



D-Sub Miniature - Slotted		Black = inches Blue = mm															
PART NUMBER	TYPE	A	B	C	D	E	F	G	H								
09D-210-XX	9 Pin	1.41	35.81	0.98	24.89	0.78	19.81	0.44	11.18	0.22	5.59	0.69	17.53	0.025	0.63	0.13	3.30
09D-200-SS	9 Pin	1.41	35.81	0.98	24.89	0.78	19.81	0.44	11.18	0.22	5.59	0.69	17.53	0.025	0.63	0.13	3.30
15D-210-XX	15 Pin	1.74	44.20	1.31	33.27	1.11	28.19	0.44	11.18	0.22	5.59	0.69	17.53	0.025	0.63	0.13	3.30
15D-200-SS	15 Pin	1.74	44.20	1.31	33.27	1.11	28.19	0.44	11.18	0.22	5.59	0.69	17.53	0.025	0.63	0.13	3.30
25D-210-XX	25 Pin	2.28	57.91	1.85	46.99	1.65	41.91	0.44	11.18	0.22	5.59	0.69	17.53	0.025	0.63	0.13	3.30
25D-200-SS	25 Pin	2.28	57.91	1.85	46.99	1.65	41.91	0.44	11.18	0.22	5.59	0.69	17.53	0.025	0.63	0.13	3.30
37D-210-XX	37 Pin	2.93	74.42	2.50	63.50	2.29	58.17	0.44	11.18	0.22	5.59	0.69	17.53	0.025	0.63	0.13	3.30
37D-200-SS	37 Pin	2.93	74.42	2.50	63.50	2.29	58.17	0.44	11.18	0.22	5.59	0.69	17.53	0.025	0.63	0.13	3.30
50D-210-XX	50 Pin	2.84	72.14	2.41	61.21	2.11	53.59	0.55	13.97	0.28	7.11	0.80	20.32	0.025	0.63	0.24	6.10
50D-200-SS	50 Pin	2.84	72.14	2.41	61.21	2.11	53.59	0.55	13.97	0.28	7.11	0.80	20.32	0.025	0.63	0.24	6.10

XX - Denotes the availability of finish/plating options. See chart above. Example: 09D-210-BD SS - Denotes stainless steel.

* For fabric option - See page 34.



THIN GAUGE CUSTOM MECHANICAL SPRINGS & STAMPINGS

For over 30 years, Leader Tech has been supplying customers with high quality precision custom prototypes, short run and high volume stampings. Our in-house tool & die design and build expertise, combined with our extensive manufacturing capabilities, allow us to manufacture custom precision components for many applications. Our expertise is not limited to just the stamping portion of the application but can include value added operations such as the addition of insulating materials, hardware and other required features. From prototype to high volume production runs, Leader Tech can meet your custom needs with the shortest and most reliable lead times in the industry.

From prototypes within days to long production runs, your Leader Tech Team is ready to assist you. Please call us at 813-855-6921 or email us at sales@leadertechinc.com with your requirements.



CONDUCTIVE ELASTOMER EMI SHIELDING GASKETS FOR ELECTRONIC ENCLOSURES

Leader Tech's complete line of TechSIL Conductive Elastomer compounds is QPL certification by the Defense Logistics Agency. This unrivaled commitment to excellence distinguishes our company as the only MIL-SPEC approved & certified manufacturer of all 12 conductive elastomer formulations. This prestigious designation authorizes us to formulate, extrude and mold conductive elastomers to stringent MIL-DTL-83528D specifications.

Leader Tech's high-performance TechSIL gaskets are manufactured using proprietary base formulations of silicone, fluorosilicone and EPDM rubber that are embedded with highly conductive fillers including: Silver, Silver/Copper, Silver/Aluminum, Silver/Nickel, Silver/Glass, and Nickel Coated Graphite. We offer numerous standard gasket profiles as well as unlimited variations of extruded, molded, sheet stock, and die-cut finishes.

TechSIL Conductive Elastomers provide engineers with a highly customizable gasketing solution that delivers a shielding effectiveness of up to 110 dB across wide temperature variations and environmental conditions. An onsite applications engineer is also available to help formulate materials to meet your custom requirements. To learn more about this product line and our capabilities, make sure to request or download the complete TechSIL Conductive Elastomer catalog from our website.

MATERIAL TYPES & PROFILES

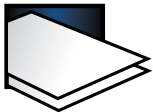

Sheet Material



Extrusions



Molded



Die Cut



Get your catalog today!
Download from our website.

**The Only MIL-SPEC Approved & Certified Manufacturer
of All 12 Conductive Elastomer Compounds!**

MIL-DTL-83528 Approved



ORIENTED WIRE SERIES

Leader Tech's *TechSIL 8000 Oriented Wire* gasketing is designed for use in suppressing EMI/RFI up to 100 dB in the E-Field/up to 50 dB in the H-Field, while offering an effective environmental seal between mating surfaces. This material is comprised of monel or aluminum wire oriented perpendicular to the mating surfaces and embedded in solid or sponge silicone elastomer. The wires are crimped for additional resiliency and to optimize the mechanical performance of the gasket. The silicone based *TechSIL* has 700-900 wires per sq./in. and is capable of withstanding temperatures from -80° to a maximum of 500° F (-62° to 260°C). *TechSIL Oriented Wire* materials are available in strip or sheet form and can easily be die cut into complex shapes or fabricated into custom frame gaskets. All *TechSIL 8000* materials meet the DESC drawing 90046.



TechSIL® Sheet				
PART NUMBER	HEIGHT		WIDTH	
8100-0005-XX	0.032*	0.81	3.00	76.20
8100-0010-XX	0.032*	0.81	4.50	114.30
8100-0015-XX	0.032*	0.81	6.00	152.40
8100-0020-XX	0.062	1.57	3.00	76.20
8100-0025-XX	0.062	1.57	4.50	114.30
8100-0030-XX	0.062	1.57	6.00	152.40
8100-0035-XX	0.093	2.36	3.00	76.20
8100-0040-XX	0.093	2.36	4.50	114.30
8100-0045-XX	0.093	2.36	6.00	152.40
8100-0050-XX	0.125	3.18	3.00	76.20
8100-0055-XX	0.125	3.18	4.50	114.30
8100-0060-XX	0.125	3.18	6.00	152.40
8100-0065-XX	0.188	4.78	3.00	76.20
8100-0070-XX	0.188	4.78	4.50	114.30
8100-0075-XX	0.188	4.78	6.00	152.40
8100-0080-XX	0.250	6.35	3.00	76.20
8100-0085-XX	0.250	6.35	4.50	114.30
8100-0090-XX	0.250	6.35	6.00	152.40



Black = inches
Blue = mm

*0.032" thickness is only available in Silicone Solid

TechSIL® Strip				
PART NUMBER	HEIGHT		WIDTH	
8200-0005-XX	0.062	1.57	0.093	2.36
8200-0010-XX	0.062	1.57	0.125	3.18
8200-0015-XX	0.062	1.57	0.188	4.78
8200-0020-XX	0.062	1.57	0.250	6.35
8200-0025-XX	0.062	1.57	0.375	9.53
8200-0030-XX	0.062	1.57	0.500	12.70
8200-0035-XX	0.093	2.36	0.093	2.36
8200-0040-XX	0.093	2.36	0.125	3.18
8200-0045-XX	0.093	2.36	0.188	4.78
8200-0050-XX	0.093	2.36	0.250	6.35
8200-0055-XX	0.093	2.36	0.375	9.53
8200-0060-XX	0.093	2.36	0.500	12.70
8200-0065-XX	0.125	3.18	0.125	3.18
8200-0070-XX	0.125	3.18	0.188	4.78
8200-0075-XX	0.125	3.18	0.250	6.35
8200-0080-XX	0.125	3.18	0.375	9.53
8200-0085-XX	0.125	3.18	0.500	12.70
8200-0090-XX	0.188	4.78	0.188	4.78
8200-0095-XX	0.188	4.78	0.250	6.35
8200-0100-XX	0.188	4.78	0.375	9.53
8200-0105-XX	0.188	4.78	0.500	12.70
8200-0110-XX	0.250	6.35	0.250	6.35
8200-0115-XX	0.250	6.35	0.375	9.53
8200-0120-XX	0.250	6.35	0.500	12.70

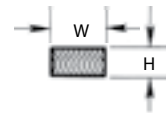

Black = inches
Blue = mm

Material Code	Wire Specification	Elastomer
-81	Monel Wire - 0.0045 Dia. (0.10) Per QQ-N-281	Silicone Sponge Per AMS 3195
-82	Monel Wire - 0.0045 Dia. (0.10) Per QQ-N-281	Silicone Solid ZZR765, Class 2B, Grade 40
-83	Aluminum Wire - 0.005 Dia. (0.13) Alloy 5056	Silicone Sponge Per AMS 3195
-84	Aluminum Wire - 0.005 Dia. (0.13) Alloy 5056	Silicone Solid ZZR765, Class 2B, Grade 40

All materials available with tape.

The data presented is accurate and true to our knowledge. Since applications, test methods and test procedures may vary, we recommend that users perform their own tests to assure suitability for specific applications. We offer no product warranty, either expressed or implied, except we will replace any product found to be defective.

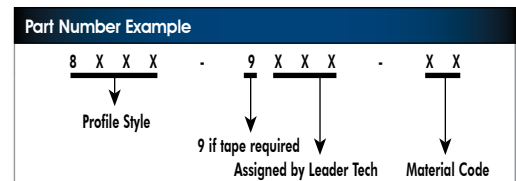

TECHMESH KNITTED WIRE

Leader Tech's *TechMESH Knitted Wire* gaskets are designed to provide EMI/RFI Shielding of joints and seams of electronic enclosures. The unique construction of the *TechMESH Knitted Wire* consists of many interlocking loops that act as small springs which provide for a resilient all-metal conductive gasket with high attenuation characteristics. *TechMESH* provides shielding effectiveness up to 130 dB in the E-Field and up to 80 dB in the H-Field. The standard wire materials are Tin Plated Copper Clad Steel, Monel and Aluminum in cross-sections of rectangular, round, round-with-fin, and double-round-with-fin. All cross-sections are available in both ALL Mesh or Elastomer Core configurations. The *TechMESH Knitted Wire* gaskets are supplied on spools of 25 ft. or cut to our customers specification.



Additional wire options are available upon request

Round All Mesh		
PART NUMBER	DIAMETER	
7000-0005-XX	0.062	1.57
7000-0010-XX	0.093	2.36
7000-0015-XX	0.125	3.18
7000-0020-XX	0.156	3.96
7000-0025-XX	0.188	4.78
7000-0030-XX	0.250	6.35
7000-0035-XX	0.312	7.92
7000-0040-XX	0.375	9.53
7000-0055-XX	0.500	12.70

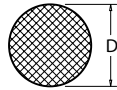

Black = inches
Blue = mm

Tape is not available.

Rectangular All Mesh				
PART NUMBER	HEIGHT		WIDTH	
7200-0005-XX	0.062	1.57	0.062	1.57
7200-0010-XX	0.062	1.57	0.125	3.18
7200-0015-XX	0.062	1.57	0.250	6.35
7200-0020-XX	0.093	2.36	0.093	2.36
7200-0025-XX	0.093	2.36	0.125	3.18
7200-0030-XX	0.093	2.36	0.250	6.35
7200-0035-XX	0.125	3.18	0.125	3.18
7200-0040-XX	0.125	3.18	0.250	6.35
7200-0045-XX	0.125	3.18	0.500	12.70
7200-0050-XX	0.188	4.78	0.188	4.78
7200-0055-XX	0.188	4.78	0.500	12.70
7200-0060-XX	0.250	6.35	0.250	6.35
7200-0065-XX	0.250	6.35	0.500	12.70



Black = inches
Blue = mm

Round All Mesh with Fin				
PART NUMBER	DIAMETER	WIDTH		
7100-0005-XX	0.062	1.57	0.375	9.53
7100-0010-XX	0.062	1.57	0.500	12.70
7100-0015-XX	0.093	2.36	0.375	9.53
7100-0020-XX	0.093	2.36	0.500	12.70
7100-0025-XX	0.125	3.18	0.375	9.53
7100-0030-XX	0.125	3.18	0.500	12.70
7100-0035-XX	0.188	4.78	0.500	12.70
7100-0040-XX	0.188	4.78	0.750	19.05
7100-0045-XX	0.250	6.35	0.500	12.70
7100-0050-XX	0.250	6.35	0.750	19.05
7100-0055-XX	0.312	7.92	0.875	22.23
7100-0060-XX	0.375	9.53	0.750	19.05
7100-0065-XX	0.500	12.70	0.750	19.05



Black = inches
Blue = mm

Tape is not available.

Double Round All Mesh with Fin				
PART NUMBER	DIAMETER	WIDTH		
7300-0005-XX	0.062	1.57	0.38	9.65
7300-0010-XX	0.062	1.57	0.50	12.70
7300-0015-XX	0.062	1.57	0.75	19.05
7300-0020-XX	0.093	2.36	0.50	12.70
7300-0025-XX	0.125	3.18	0.50	12.70
7300-0030-XX	0.125	3.18	0.75	19.05
7300-0035-XX	0.125	3.18	1.00	25.40
7300-0040-XX	0.188	4.78	0.63	16.00
7300-0045-XX	0.188	4.78	0.75	19.05
7300-0050-XX	0.188	4.78	1.00	25.40
7300-0055-XX	0.250	6.35	0.75	19.05
7300-0060-XX	0.250	6.35	1.00	25.40
7300-0065-XX	0.375	9.53	1.00	25.40



Black = inches
Blue = mm

Tape is not available.

Material Code	Wire Specification
-71	Tin Plated Copper Clad Steel - 0.0045 Dia. (0.10) ASTM-B-520
-72	Monel Wire - 0.0045 Dia. (0.10) Per QQ-N-281
-73	Aluminum Wire - 0.005 Dia. (0.13) Alloy 5056, Per AMS-4182

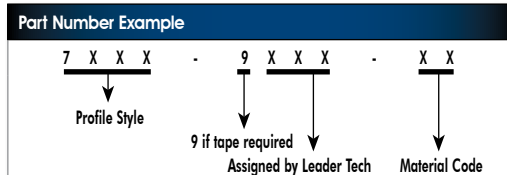

TECHMESH ELASTOMER CORE WIRE

Material Code	Wire Specification	Elastomer
-74	Monel Wire - 0.0045 Dia. (0.10) Per QQ-N-281B	Neoprene Sponge MIL-R-6130B, Type II, Grade A
-75	Monel Wire - 0.0045 Dia. (0.10) Per QQ-N-281B	Silicone Sponge Per AMS 3195
-76	Monel Wire - 0.0045 Dia. (0.10) Per QQ-N-281B	Silicone Solid Per ZZR765, Class 2B, Grade 40
-77	Tin Plated Copper Clad Steel 0.0045 Dia. (0.10) ASTM-B-520	Neoprene Sponge MIL-R-6130B, Type II, Grade A
-78	Tin Plated Copper Clad Steel 0.0045 Dia. (0.10) ASTM-B-520	Silicone Sponge Per AMS 3195
-79	Tin Plated Copper Clad Steel 0.0045 Dia. (0.10) ASTM-B-520	Silicone Solid Per ZZR765, Class 2B, Grade 40



Solid | Elastomer Mesh

PART NUMBER	DIAMETER	
7400-0005-XX	0.062	1.57
7400-0010-XX	0.125	3.18
7400-0015-XX	0.188	4.78
7400-0020-XX	0.250	6.35
7400-0025-XX	0.312	7.92
7400-0030-XX	0.375	9.53
7400-0035-XX	0.500	12.70

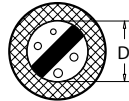

Black = inches
Blue = mm

Tape is not available.

Hollow | Elastomer Mesh

PART NUMBER	DIAMETER	
7600-0005-XX	0.188	4.78
7600-0010-XX	0.250	6.35
7600-0015-XX	0.375	9.53
7600-0020-XX	0.500	12.70

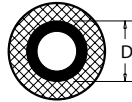

Black = inches
Blue = mm

Tape is not available.
Not available in -75 or -78 material

Rectangular | Elastomer Mesh

PART NUMBER	HEIGHT		WIDTH	
7500-0005-XX	0.125	3.18	0.125	3.18
7500-0010-XX	0.125	3.18	0.188	4.78
7500-0015-XX	0.125	3.18	0.250	6.35
7500-0020-XX	0.188	4.78	0.188	4.78
7500-0025-XX	0.250	6.35	0.250	6.35
7500-0030-XX	0.250	6.35	0.375	9.53
7500-0035-XX	0.250	6.35	0.500	12.70
7500-0040-XX	0.375	9.53	0.500	12.70
7500-0045-XX	0.500	12.70	0.500	12.70
7500-0050-XX	0.500	12.70	0.750	19.05

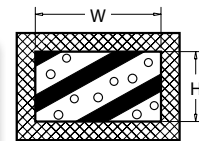

Black = inches
Blue = mm

P-Bulb | Elastomer Mesh

PART NUMBER	DIAMETER	WIDTH	
7700-0005-XX	0.125	3.18	0.500
7700-0010-XX	0.125	3.18	0.625
7700-0015-XX	0.125	3.18	0.750
7700-0020-XX	0.188	4.78	0.500
7700-0025-XX	0.188	4.78	0.625
7700-0030-XX	0.188	4.78	0.750
7700-0035-XX	0.250	6.35	0.500
7700-0040-XX	0.250	6.35	0.750
7700-0045-XX	0.250	6.35	1.000
7700-0050-XX	0.500	12.70	1.000

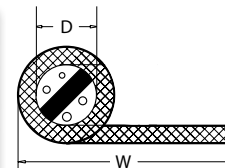

Black = inches
Blue = mm

Part Number Example

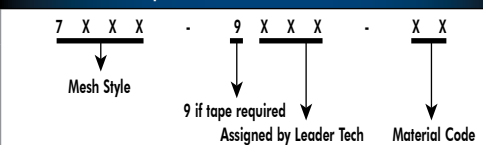

TECHMESH COMBO STRIP

Leader Tech's *TechMesh Combo Strip & Gaskets* are designed for use in applications requiring EMI/RFI shielding and environmental sealing. These materials are comprised of monel or tin plated copper clad steel knitted wire mesh which are bonded to neoprene sponge, silicone sponge or silicone solid elastomer strips. The wire mesh provides shielding performance up to 125 dB in the E-Field and up to 80 dB in the H-Field while the elastomer materials can withstand temperatures from -103° to a maximum of 500° F (-75° to 260°C). These materials have an optional pressure sensitive adhesive backing for ease of installation. The *TechMesh Combo Strip & Gaskets* are available in standard and custom strip configurations. Leader Tech can also fabricate custom frame gaskets to customers specification.



Additional wire options or metal compression stops are available upon request.

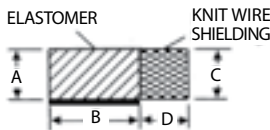

Single Mesh Combo Gasket								
PART NUMBER	ELASTOMER				MESH			
	HEIGHT (A)		WIDTH (B)		HEIGHT (C)		WIDTH (D)	
7800-0005-XX	0.062	1.57	0.250	6.35	0.062	1.57	0.125	3.18
7800-0010-XX	0.062	1.57	0.375	9.53	0.062	1.57	0.125	3.18
7800-0015-XX	0.062	1.57	0.500	12.70	0.062	1.57	0.125	3.18
7800-0020-XX	0.093	2.36	0.250	6.35	0.093	2.36	0.125	3.18
7800-0025-XX	0.093	2.36	0.375	9.53	0.093	2.36	0.125	3.18
7800-0030-XX	0.093	2.36	0.500	12.70	0.093	2.36	0.125	3.18
7800-0035-XX	0.125	3.18	0.250	6.35	0.125	3.18	0.125	3.18
7800-0040-XX	0.125	3.18	0.375	9.53	0.125	3.18	0.125	3.18
7800-0045-XX	0.125	3.18	0.500	12.70	0.125	3.18	0.125	3.18
7800-0050-XX	0.125	3.18	0.750	19.05	0.125	3.18	0.125	3.18
7800-0055-XX	0.188	4.78	0.375	9.53	0.188	4.78	0.125	3.18
7800-0060-XX	0.188	4.78	0.500	12.70	0.188	4.78	0.125	3.18
7800-0065-XX	0.188	4.78	0.750	19.05	0.188	4.78	0.125	3.18
7800-0070-XX	0.250	6.35	0.500	12.70	0.250	6.35	0.125	3.18
7800-0075-XX	0.250	6.35	0.750	19.05	0.250	6.35	0.125	3.18

Black = inches
Blue = mm

Double Mesh Combo Gasket								
PART NUMBER	ELASTOMER				MESH			
	HEIGHT (A)		WIDTH (B)		HEIGHT (C)		WIDTH (D)	
7900-0005-XX	0.062	1.57	0.250	6.35	0.062	1.57	0.125	3.18
7900-0010-XX	0.062	1.57	0.500	12.70	0.062	1.57	0.125	3.18
7900-0015-XX	0.093	2.36	0.250	6.35	0.093	2.36	0.125	3.18
7900-0020-XX	0.093	2.36	0.500	12.70	0.093	2.36	0.125	3.18
7900-0025-XX	0.125	3.18	0.250	6.35	0.125	3.18	0.125	3.18
7900-0030-XX	0.125	3.18	0.375	9.53	0.125	3.18	0.125	3.18
7900-0035-XX	0.125	3.18	0.500	12.70	0.125	3.18	0.125	3.18
7900-0040-XX	0.188	4.78	0.250	6.35	0.188	4.78	0.125	3.18
7900-0045-XX	0.188	4.78	0.500	12.70	0.188	4.78	0.125	3.18

Black = inches
Blue = mm

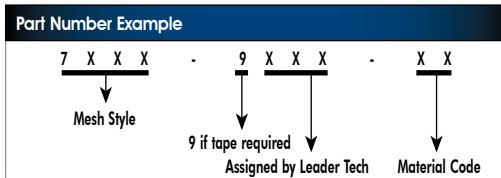

Material Code	Wire Specification	Elastomer
-74	Monel Wire - 0.0045 Dia. (0.10) Per QQ-N-281B	Neoprene Sponge MIL-R-6130B, Type II, Grade A
-75	Monel Wire - 0.0045 Dia. (0.10) Per QQ-N-281B	Silicone Sponge Per AMS 3195
-76	Monel Wire - 0.0045 Dia. (0.10) Per QQ-N-281B	Silicone Solid Per ZZR765, Class 2B, Grade 40
-77	Tin Plated Copper Clad Steel 0.0045 Dia. (0.10) ASTM-B-520	Neoprene Sponge MIL-R-6130B, Type II, Grade A
-78	Tin Plated Copper Clad Steel 0.0045 Dia. (0.10) ASTM-B-520	Silicone Sponge Per AMS 3195
-79	Tin Plated Copper Clad Steel 0.0045 Dia. (0.10) ASTM-B-520	Silicone Solid Per ZZR765, Class 2B, Grade 40

The data presented is accurate and true to our knowledge. Since applications, test methods and test procedures may vary, we recommend that users perform their own tests to assure suitability for specific applications. We offer no product warranty, either expressed or implied, except we will replace any product found to be defective.

TECHMESH TAPE

Leader Tech's **TechMESH Tape** has double layered strip of knitted wire mesh to provide effective EMI shielding and grounding for electric and electronic cable assemblies. This is particularly useful in applications where the need for EMI protection is determined after the cable assembly is complete and standard braided shielded cable cannot be used. The flexible structure of Leader **TechMESH Tape** permits it to conform to irregular surfaces and the cable contours during the wrapping process. **TechMESH Tape** is 0.020" (0,51mm) thick. It is available in tin plated copper clad steel (-71) or Monel (-72) width 10-12 openings per inch.



Performance Advantages

- Tin plated for excellent solderability
- Useful in both shielding and grounding applications for static discharge
- Tin plated copper clad steel wire provides greater strength and performance than other mesh tape materials
- Knit loop structure provides uniform coverage minimizing wrinkles and creases
- Available in other alloys and wire dimensions
- Supplied in 50 ft. (15,2mm) rolls (Note: When determining quantity needed, 50% overlap is recommended)

6000 Tape		
PART NUMBER	WIDTH	
6000-0025-XX	0.250 +/- 0.40	6.4 +/- 1.0
6000-0038-XX	0.380 +/- 0.40	9.7 +/- 1.0
6000-0050-XX	0.500 +/- 0.60	12.7 +/- 1.5
6000-0075-XX	0.750 +/- 0.60	19.1 +/- 24.4
6000-0100-XX	1.00 +/- 0.60	25.4 +/- 1.5
6000-0150-XX	1.50 +/- 0.120	38.1 +/- 3.1
6000-0175-XX	1.75 +/- 0.120	44.5 +/- 3.1
6000-0225-XX	2.25 +/- 0.120	57.2 +/- 4.8

Black = inches
Blue = mm

6000 Tape	
MATERIAL CODE	WIRE SPECIFICATION
-71	Tin Plated Copper Clad Steel - 0.0045 Dia. (0.10) ASTM-B-520
-72	Monel Wire - 0.0045 Dia. (0.10) Per QQ-N-281

Part Number Explanation		
6 0 0 0	- X X X X -	X X
↓	↓	↓
Profile Style	Select Size from chart above	Material Code

TECHNICAL DATA

Shielding gaskets are, very simply, connectors of two opposing metallic planes which make them appear as one continuous surface, by connecting across the openings. Depending on the frequencies involved, the openings must be reduced as closely as possible to a continuous seal.

Leader Tech's unique Fabric Shielding Gasket structure is a combination of a highly conductive nickel/copper ripstop fabric and a resilient polyurethane foam core. Leader Tech's FSG products have superior shielding properties and ensure long performance life all in a cost effective manner.

Leader Tech (FSG):

Fabric: Nickel/Copper RipStop

Foam: Open Cell Polyurethane

Compression Set: <15% (ASTM D3574)

Temperature Range: -40°F to 158°F (-40°C to 70°C) (ASTM D746)

Surface Resistivity: ≤0.050 Ω/inch² (ASTM F390)

Flammability Rating: UL94V0

Shielding Effectiveness: >Up to 105 dB (MIL-DTL-83528C)

Pressure Sensitive Adhesive: Non-conductive, high peel strength

ROHS: Compliant

REACH: Compliant

SHELF LIFE: If stored properly, product retains its performance and properties for 24 months from date of manufacture. (It is suggested that products are stored at room temperature conditions of 70°F (21°C) and 50% relative humidity.)

Tolerances:

TYPICAL CROSS SECTION TOLERANCES

±.010 in. (0.25 mm) for all dimensions up to 0.04 in. (1.02 mm)

±.020 in. (0.50 mm) for all dimensions above 0.04 in. (1.02 mm)

(Detailed part drawings are available upon request)

TYPICAL LENGTH TOLERANCES

0.20 to 6.00 in.	(5 - 152 mm)	±.03 in.	(0.76 mm)
6.01 to 18.00 in.	(153 - 457 mm)	±.06 in.	(1.52 mm)
18.01 to 48.00 in.	(458 - 1219 mm)	±.08 in.	(2.03 mm)

*Other sizes available.
Consult factory.

Shelf-life is based on the pressure sensitive adhesive which is 24 months



FSG FOR ELECTRONIC ENCLOSURES

Square Shape						
PART NUMBER	HEIGHT	WIDTH	LENGTH			
SG080080S	0.080	2.03	0.080	2.03	48	1219
SG118118S	0.118	3.00	0.118	3.00	48	1219
SG138138S	0.138	3.54	0.138	3.54	48	1219
SG160160S	0.160	4.06	0.160	4.06	48	1219
SG200200S	0.200	5.08	0.200	5.08	48	1219
SG250250S	0.250	6.35	0.250	6.35	48	1219
SG315315S	0.315	8.00	0.315	8.00	48	1219
SG354354S	0.354	8.99	0.354	8.99	48	1219
SG375375S	0.375	9.52	0.375	9.52	48	1219
SG472472S	0.472	11.99	0.472	11.99	48	1219
SG500500S	0.500	12.70	0.500	12.70	48	1219
SG512512S	0.512	13.00	0.512	13.00	48	1219
SG551551S	0.551	14.00	0.551	14.00	48	1219
SG575575S	0.575	14.60	0.575	14.60	48	1219
SG591591S	0.591	15.01	0.591	15.01	48	1219
SG670670S	0.670	17.02	0.670	17.02	48	1219
SG787787S	0.787	19.99	0.787	19.99	48	1219

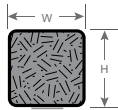

Black = inches
Blue = mm

Bell Shape						
PART NUMBER	HEIGHT	WIDTH	LENGTH			
SG070180B	0.070	1.78	0.180	4.57	48	1219
SG090315B	0.090	2.29	0.315	8.00	48	1219
SG098299B	0.098	2.49	0.299	7.59	48	1219
SG100300B	0.100	2.54	0.300	7.62	48	1219
SG130256B	0.130	3.30	0.256	6.50	48	1219
SG157500B	0.157	3.99	0.500	12.70	48	1219
SG200500B	0.200	5.08	0.500	12.70	48	1219



Black = inches
Blue = mm

T-Shape						
PART NUMBER	HEIGHT	WIDTH	LENGTH			
SG152235T	0.152	3.86	0.235	5.97	48	1219
SG157245T	0.157	3.99	0.245	6.22	48	1219
SG175244T	0.175	4.44	0.244	6.20	48	1219
SG244244T	0.244	6.20	0.244	6.20	48	1219



Black = inches
Blue = mm

C-Shape						
PART NUMBER	HEIGHT	WIDTH	LENGTH			
SG196325C	0.196	4.98	0.325	8.25	48	1219
SG196535C	0.196	4.98	0.535	13.59	48	1219
SG240415C	0.240	6.10	0.415	10.54	48	1219
SG252280C	0.252	6.40	0.280	7.11	48	1219
SG315315C	0.315	8.00	0.315	8.00	48	1219
SG347685C	0.347	8.81	0.685	17.40	48	1219
SG380420C	0.380	9.65	0.420	10.67	48	1219
SG385420C	0.385	9.78	0.420	10.67	48	1219
SG465420C	0.465	11.811	0.420	10.67	48	1219
SG550590C	0.550	13.97	0.590	14.99	48	1219
SG675580C	0.675	17.14	0.580	14.73	48	1219
SG675600C	0.675	17.14	0.600	15.24	48	1219

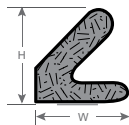

Black = inches
Blue = mm

Typical Performance

Shielding Effectiveness
80 - 115dB

Frequency Range
20Mhz - 10GHz

Dura-Layer Construction
Polyurethane foam core with high-performance fabric

Recommended Compression
30-50% of gasket height

Typical Cross Section Tolerances			
±.010 in.	(0.25 mm) for all dimensions up to	0.04 in.	(1.02 mm)
±.020 in.	(0.50 mm) for all dimensions above	0.04 in.	(1.02 mm)
Detailed part drawings are available upon request.			
Typical Length Tolerances			
0.20 to 6.00 in.	(5 - 152 mm)	±.03 in.	(0.76 mm)
6.01 to 18.00 in.	(153 - 457 mm)	±.06 in.	(1.52 mm)
18.01 to 48.00 in.	(458 - 1219 mm)	±.08 in.	(2.03 mm)

Part Number Explanation				
SG	X X X	X X X	X	- X X . X X
↓	↓	↓	↓	↓
#Start	Height	Width	Profile	Length
*Example: SG125250D-22.50: Gasket .125 tall, .250 wide, D-Shape and 22.5" long				

FSG FOR ELECTRONIC ENCLOSURES *CONT.*

Rectangle Shape						
PART NUMBER	HEIGHT		WIDTH		LENGTH	
SG020157R	0.020	0.51	0.157	3.99	48	1219
SG020197R	0.020	0.51	0.197	5.00	48	1219
SG020275R	0.020	0.51	0.275	6.98	48	1219
SG0391181R	0.039	0.99	1.181	30.00	48	1219
SG039118R	0.039	0.99	0.118	3.00	48	1219
SG040125R	0.040	1.02	0.125	3.17	48	1219
SG0401850R	0.040	1.02	1.850	46.99	48	1219
SG040200R	0.040	1.02	0.200	5.08	48	1219
SG040275R	0.040	1.02	0.275	6.98	48	1219
SG040395R	0.040	1.02	0.395	10.03	48	1219
SG040590R	0.040	1.02	0.590	14.99	48	1219
SG040710R	0.040	1.02	0.710	18.03	48	1219
SG050090R	0.050	1.27	0.090	2.29	48	1219
SG051157R	0.051	1.30	0.157	3.99	48	1219
SG051394R	0.051	1.30	0.394	10.01	48	1219
SG060100R	0.060	1.52	0.100	2.54	48	1219
SG060125R	0.060	1.52	0.125	3.17	48	1219
SG060130R	0.060	1.52	0.130	3.30	48	1219
SG060160R	0.060	1.52	0.160	4.06	48	1219
SG060200R	0.060	1.52	0.200	5.08	48	1219
SG060280R	0.060	1.52	0.280	7.11	48	1219
SG060394R	0.060	1.52	0.394	10.01	48	1219
SG060395R	0.060	1.52	0.395	10.03	48	1219
SG060750R	0.060	1.52	0.750	19.05	48	1219
SG079157R	0.079	2.00	0.157	3.99	48	1219
SG0801000R	0.080	2.03	1.000	25.40	48	1219
SG080100R	0.080	2.03	0.100	2.54	48	1219
SG080160R	0.080	2.03	0.160	4.06	48	1219
SG080200R	0.080	2.03	0.200	5.08	48	1219
SG080500R	0.080	2.03	0.500	12.70	48	1219
SG080750R	0.080	2.03	0.750	19.05	48	1219
SG100200R	0.100	2.54	0.200	5.08	48	1219
SG118118R	0.118	3.00	0.118	3.00	48	1219
SG120155R	0.120	3.05	0.155	3.94	48	1219
SG125250R	0.125	3.17	0.250	6.35	48	1219
SG125375R	0.125	3.17	0.375	9.52	48	1219
SG140250R	0.140	3.56	0.250	6.35	48	1219

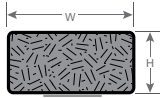

Black = inches
Blue = mm

Rectangle Shape <i>cont.</i>						
PART NUMBER	HEIGHT		WIDTH		LENGTH	
SG157590R	0.157	3.99	0.590	14.99	48	1219
SG160354R	0.160	4.06	0.354	8.99	48	1219
SG250375R	0.250	6.35	0.375	9.52	48	1219
SG250500R	0.250	6.35	0.500	12.70	48	1219
SG250600R	0.250	6.35	0.600	15.24	48	1219
SG187375R	0.187	4.75	0.375	9.52	48	1219
SG187750R	0.187	4.75	0.750	19.05	48	1219
SG197315R	0.197	5.00	0.315	8.00	48	1219
SG200200R	0.200	5.08	0.200	5.08	48	1219
SG250250R	0.250	6.35	0.250	6.35	48	1219
SG375500R	0.375	9.52	0.500	12.70	48	1219
SG500500R	0.500	12.70	0.500	12.70	48	1219
SG500750R	0.500	12.70	0.750	19.05	48	1219
SG670670R	0.670	17.02	0.670	17.02	48	1219
SG787787R	0.787	19.99	0.787	19.99	48	1219

Black = inches
Blue = mm

Knife Edge						
PART NUMBER	HEIGHT		WIDTH		LENGTH	
SG070340K	0.070	1.78	0.340	8.64	48	1219
SG106315K	0.106	2.69	0.315	8.00	48	1219
SG106445K	0.106	2.69	0.445	11.30	48	1219
SG106455K	0.106	2.69	0.455	11.56	48	1219
SG-160600K	0.106	2.69	0.600	15.24	48	1219
SG187236K	0.187	4.75	0.236	5.99	48	1219
SG250750K	0.250	6.35	0.750	19.05	48	1219
SG312707K	0.312	7.92	0.270	6.86	48	1219
SG350750K	0.350	8.89	0.750	19.05	48	1219



Black = inches
Blue = mm

Round Shape			
PART NUMBER	DIAMETER		LENGTH
SG100100Z	0.100	2.54	48 1219
SG125125Z	0.125	3.17	48 1219
SG160160Z	0.160	4.06	48 1219
SG200200Z	0.200	5.08	48 1219

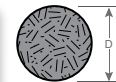

Black = inches
Blue = mm

Tape is not available.

Typical Cross Section Tolerances		
±.010 in. (0.25 mm)	for all dimensions up to	0.04 in. (1.02 mm)
±.020 in. (0.50 mm)	for all dimensions above	0.04 in. (1.02 mm)
Detailed part drawings are available upon request.		
Typical Length Tolerances		
0.20 to 6.00 in. (5 - 152 mm)		±.03 in. (0.76 mm)
6.01 to 18.00 in. (153 - 457 mm)		±.06 in. (1.52 mm)
18.01 to 48.00 in. (458 - 1219 mm)		±.08 in. (2.03 mm)

Part Number Explanation				
SG	X X X	X X X	X	X X . X X
↓	↓	↓	↓	↓
#Start	Height	Width	Profile	Length
*Example: SG125250D-22.50: Gasket .125 tall, .250 wide, D-Shape and 22.5" long				

FSG FOR ELECTRONIC ENCLOSURES CONT.

D-Shape						
PART NUMBER	HEIGHT	WIDTH	LENGTH			
SG040150D	0.040	1.02	0.150	3.81	48	1219
SG040200D	0.040	1.02	0.200	5.08	48	1219
SG050140D	0.050	1.27	0.140	3.56	48	1219
SG050250D	0.050	1.27	0.250	6.35	48	1219
SG060125D	0.060	1.52	0.125	3.17	48	1219
SG060150D	0.060	1.52	0.150	3.81	48	1219
SG060250D	0.060	1.52	0.250	6.35	48	1219
SG070135D	0.070	1.78	0.135	3.43	48	1219
SG70180D	0.070	1.78	0.180	4.57	48	1219
SG080080D	0.080	2.03	0.080	2.03	48	1219
SG080160D	0.080	2.03	0.160	4.06	48	1219
SG080394D	0.080	2.03	0.394	10.01	48	1219
SG090090D	0.090	2.29	0.090	2.29	48	1219
SG090150D	0.090	2.29	0.150	3.81	48	1219
SG094200D	0.094	2.39	0.200	5.08	48	1219
SG100300D	0.100	2.54	0.300	7.62	48	1219
SG110180D	0.110	2.79	0.180	4.57	48	1219
SG120150D	0.120	3.05	0.150	3.81	48	1219
SG120250D	0.120	3.05	0.250	6.35	48	1219
SG120360D	0.120	3.05	0.360	9.14	48	1219
SG120475D	0.120	3.05	0.475	12.06	48	1219
SG125187D	0.125	3.17	0.187	4.75	48	1219
SG125250D	0.125	3.17	0.250	6.35	48	1219
SG130190D	0.130	3.30	0.190	4.83	48	1219
SG140250D	0.140	3.56	0.250	6.35	48	1219
SG150250D	0.150	3.81	0.250	6.35	48	1219
SG160240D	0.160	4.06	0.240	6.10	48	1219
SG180400D	0.180	4.57	0.400	10.16	48	1219
SG187250D	0.187	4.75	0.250	6.35	48	1219
SG195260D	0.195	4.95	0.260	6.60	48	1219
SG236236D	0.236	5.99	0.236	5.99	48	1219
SG250375D	0.250	6.35	0.375	9.52	48	1219
SG295355D	0.295	7.49	0.355	9.02	48	1219
SG315630D	0.315	8.00	0.630	16.00	48	1219
SG375500D	0.375	9.52	0.500	12.70	48	1219
SG430500D	0.430	10.92	0.500	12.70	48	1219
SG562709D	0.562	14.27	0.709	18.00	48	1219
SG670670D	0.670	17.02	0.670	17.02	48	1219

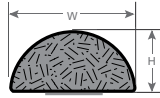

Black = inches
Blue = mm

Oval Shape						
PART NUMBER	HEIGHT	WIDTH	LENGTH			
SG140200E	0.140	3.56	0.200	5.08	48	1219
SG160790E	0.160	4.06	0.790	20.07	48	1219

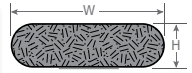

Black = inches
Blue = mm

Triangle Shape						
PART NUMBER	HEIGHT	WIDTH	LENGTH			
SG098500TR	0.098	2.49	0.500	12.70	48	1219
SG090394TR	0.090	2.29	0.394	10.01	48	1219
SG100400TR	0.100	2.54	0.400	10.16	48	1219
SG140390TR	0.140	3.56	0.390	9.91	48	1219

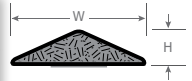

Black = inches
Blue = mm

P-Shape						
PART NUMBER	HEIGHT	WIDTH	LENGTH			
SG016195P	0.016	0.41	0.195	4.95	48	1219
SG060275P	0.060	1.52	0.275	6.98	48	1219
SG080200P	0.080	2.03	0.200	5.08	48	1219
SG125750P	0.125	3.17	0.750	19.05	48	1219
SG130520P	0.130	3.30	0.520	13.20	48	1219
SG145520P	0.145	3.68	0.520	13.21	48	1219
SG200395P	0.200	5.08	0.395	10.03	48	1219



Black = inches
Blue = mm

Typical Performance

Shielding Effectiveness
80 - 115dB

Frequency Range
20Mhz - 10GHz

Dura-Layer Construction
Polyurethane foam core with high-performance fabric

Recommended Compression
30-50% of gasket height

Typical Cross Section Tolerances			
±.010 in.	(0.25 mm)	for all dimensions up to	0.04 in. (1.02 mm)
±.020 in.	(0.50 mm)	for all dimensions above	0.04 in. (1.02 mm)
Detailed part drawings are available upon request.			
Typical Length Tolerances			
0.20 to 6.00 in.	(5 - 152 mm)	±.03 in.	(0.76 mm)
6.01 to 18.00 in.	(153 - 457 mm)	±.06 in.	(1.52 mm)
18.01 to 48.00 in.	(458 - 1219 mm)	±.08 in.	(2.03 mm)

Part Number Explanation				
SG	X X X	X X X	X	X X . X X
↓	↓	↓	↓	↓
#Start	Height	Width	Profile	Length
*Example: SG125250D-22.50: Gasket .125 tall, .250 wide, D-Shape and 22.5" long				

FSG FOR ELECTRONIC ENCLOSURES CONT.

D-SUB MINIATURE

very conformable to irregular surfaces.

- Eliminates any gap problem between connector and I/O surface plates. Compresses from .100" to .025" (2.5 to 0.6mm)
- Outside conductive surface is metalized CuNi fabric
- 9, 15, 25, 37 and 50 pin connector gaskets available in stock
- Available with adhesive tape. Please consult factory for ordering information
- Consult factory for custom profiles, thicknesses and sizes available
- For metal option - see page 22

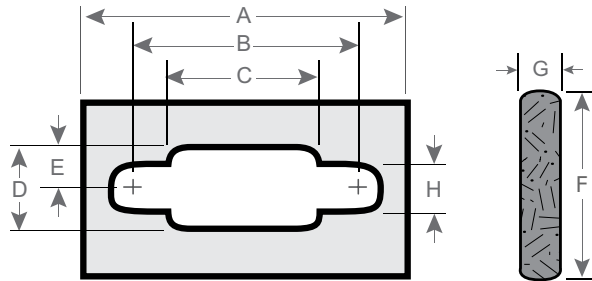

D-Sub Miniature																	
PART NUMBER	TYPE	A	B	C	D	E	F	G	H								
SG140009DS	9 Pin	1.40	35.56	0.98	24.89	0.78	19.81	0.44	11.18	0.22	5.59	0.7	17.78	0.1	2.54	0.15	3.81
SG175015DS	15 Pin	1.75	44.45	1.31	33.27	1.11	28.19	0.44	11.18	0.22	5.59	0.7	17.78	0.1	2.54	0.15	3.81
SG228025DS	25 Pin	2.28	57.91	1.85	46.99	1.65	41.91	0.44	11.18	0.22	5.59	0.7	17.78	0.1	2.54	0.15	3.81
SG293037DS	37 Pin	2.93	74.42	2.50	63.54	2.29	58.17	0.44	11.18	0.22	5.59	0.7	17.78	0.1	2.54	0.15	3.81
SG284050DS	50 Pin	2.84	72.14	2.41	61.21	2.20	55.88	0.55	13.97	0.28	7.11	0.8	20.32	0.1	2.54	0.15	3.81

Black = inches
Blue = mm

Typical Performance

Shielding Effectiveness
80 - 115dB

Frequency Range
20Mhz - 10GHz

Dura-Layer Construction
Polyurethane foam core with high-performance fabric

Recommended Compression
30-50% of gasket height

Typical Cross Section Tolerances			
±.010 in.	(0.25 mm)	for all dimensions up to	0.04 in. (1.02 mm)
±.020 in.	(0.50 mm)	for all dimensions above	0.04 in. (1.02 mm)
Detailed part drawings are available upon request.			
Typical Length Tolerances			
0.20 to 6.00 in.	(5 - 152 mm)	±.03 in.	(0.76 mm)
6.01 to 18.00 in.	(153 - 457 mm)	±.06 in.	(1.52 mm)
18.01 to 48.00 in.	(458 - 1219 mm)	±.08 in.	(2.03 mm)

SHIELDING FABRICS & CONDUCTIVE TAPES

Shielding Fabrics

Shielding effectiveness is determined by a combination of the reflection and absorption of RF signals. Absorption depends on the thickness of the shield material. However, reflection occurs at the shield surface and its effectiveness is independent of thickness. Reflection is the determining factor for all high frequency signal attenuation. (Note: When using these materials for conductive shielding gaskets, conductivity is the determinant.) Maximum reflection occurs with the highest conductivity materials – the best being copper, nickel and combinations of both.

Applications

Bonding or laminating to complex geometric shapes with optional hot melt or conductive adhesive.

- Large surface coverage with minimal seams due to 41" material width
- ESD/RFI-EMI shielding attenuation > 70dB up to 10 GHz for CuNi type
- Seal enclosure panels and frames, seams or joints
- Use for architectural shielding or shielded room wall and ceiling finishing

Options

- All materials are available in non-adhesive, hot melt or conductive adhesive backing
- Standard sheets are 41" x 36" (1041 x 914 mm)
- Longer lengths can be custom ordered – please consult factory for information
- Full rolls are 325' (99M) long – please consult factory for ordering information. Note: conductive adhesive versions are 164' (50M) long



Shielding Fabrics														
PART NUMBER W/O ADHESIVE	W/HOT MELT ADHESIVE	W/CONDUCTIVE ADHESIVE	DESCRIPTION	WIDTH	LENGTH	THICKNESS	SURFACE RESISTIVITY	500KHZ	100MHZ	300MHZ	1GHZ			
SF005PCN	SF005PCN-HM	SF005PCN-CA	Conductive CuNi Cloth	41	1041	36	914	0.003	0.076	.005 ohm/mm2	79dB	81dB	86dB	82dB
SF030PCU	SF030PCU-HM	SF030PCU-CA	Conductive Cu Cloth	41	1041	36	914	0.003	0.076	.035 ohm/mm2	60dB	67dB	65dB	62dB
SF050PNI	SF050PNI-HM	SF050PNI-CA	Conductive Ni Cloth	41	1041	36	914	0.004	0.102	.050 ohm/mm2	60dB	72dB	67dB	63dB

Black = inches
Blue = mm



Fabric Shielding Tapes

Applications

Cable shielding, enclosure seams, shielded room joints, PCB component shields, irregular surface/component shields, alternative to custom die-cut shielding gaskets or sections.

- Service Temperature: -40°F to 212°F (-40°C to 100°C)
- Adhesion: (peel) 50 oz/in. (54N/100mm)
- Material: CuNi metalized fabric and conductive acrylic adhesive backing w/release liner

Fabric Shielding Tapes								
PART NUMBER	WIDTH	THICKNESS	LENGTH	RESISTIVITY	IMPEDANCE			
ST005PCN25	0.25	6.35	0.005	0.13	85.0 ft. rolls	25.0m	0.03 - 0.05 ohms/inch	69dB@100MHz
ST005PCN50	0.50	12.70	0.005	0.13	85.0 ft. rolls	25.0m	0.03 - 0.05 ohms/inch	69dB@100MHz
ST005PCN75	0.75	19.05	0.005	0.13	85.0 ft. rolls	25.0m	0.03 - 0.05 ohms/inch	69dB@100MHz
ST005PCN100	1.00	25.40	0.005	0.13	85.0 ft. rolls	25.0m	0.03 - 0.05 ohms/inch	69dB@100MHz
ST005PCN200	2.00	50.80	0.005	0.13	85.0 ft. rolls	25.0m	0.03 - 0.05 ohms/inch	69dB@100MHz

Black = inches
Blue = mm

CFS CONDUCTIVE FOAM SHIELDING MATERIAL FOR DIE-CUT GASKETS

CFS Conductive Foam Shielding Material consists of resilient Nickel-Copper polyurethane foam which is layered between two pieces of conductive polyester fabric. This CFS Conductive Foam is ideal for applications that require low compression forces but excellent shielding effectiveness.

Performance

Operating Temperatures: -40F – +156F (-40C - +70C)

Surface Resistivity: <0.2 ohms/sq

Shielding Effectiveness: 60dB Typical 10MHz – 3GHz

Flammability: UL94-HBF Unless otherwise noted UL94-V1*

Typical Compression Load: 2.1 PSI at recommended 30% compression

Availability

Sheets: Up to 1.0m x 1.0m (*Custom Sizes Available*)

Finishing: Precision Die-Cut Forms & Shapes

Available with Conductive Adhesive

Material Characteristics

High Shielding Effectiveness

Low Compression

Low Surface Resistivity

Applications

Intricate die cuts forms

I/O panels

Backplanes

Connectors

Access panels



CFS Conductive Foam Shielding Material		
PART NUMBER	STD SHEET SIZE	ADHESIVE
CFS1919060-NTP	19 X 19 X .060	NO
CFS1919060	19 X 19 X .060	YES
CFS1919098-NTP	19 X 19 X .098	NO
CFS1919098	19 X 19 X .098	YES
CFS1919138-NTP	19 X 19 X .138	NO
CFS1919138	19 X 19 X .138	YES
CFS2222060-V1-NTP*	22 X 22 X .060	NO
CFS2222060	22 X 22 X .060	YES

*Other sizes available.
Consult Applications Engineering.

CUSTOM AND DIE-CUT SHIELDING GASKETS

In addition to our large assortment of stock products, Leader Tech offers customers the ability to create custom and die-cut shielding gaskets using any of our conductive elastomer formulations or fabric shielding gasket materials. Our extensive manufacturing capabilities include extrusion, molding and precision die-cut shapes and sizes.

All of our high-performance custom shielding gaskets can be made from your choice of twelve MIL-DTL-83528 Conductive Elastomer compounds or from our Fabric Shielding Gasket material. Depending on your unique application requirements, our engineering team will work to develop a custom gasketing solution that exhibits superior shielding properties and ensures a long performance life in a cost effective manner.

Please review your application with our Material Specialist and Engineering Group to determine the best materials to use for your application.

Die Cut Gasket Design Recommendations and Tolerances

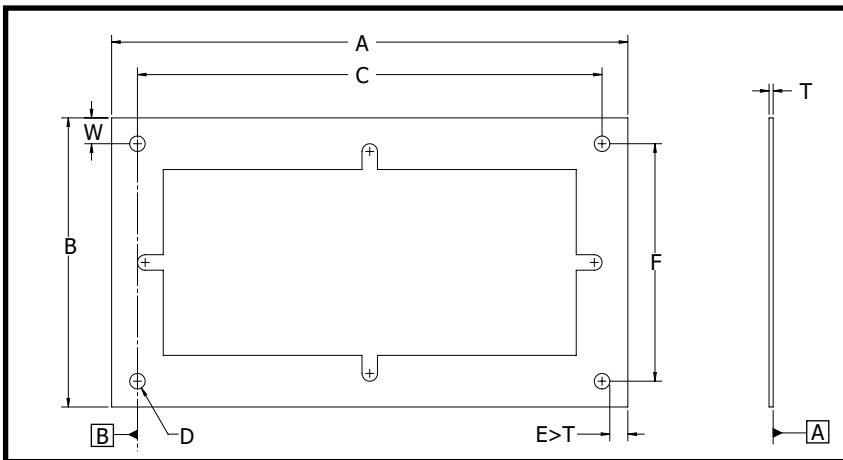

NOTES:

1. Minimum recommended flange width (W) is .125".
2. Hole diameter (D) must exceed material thickness (T).
3. Distance edge of hole to edge of gasket (E) must exceed material thickness (T).
If not possible, then a slot is required.
4. Recommend assign datum to hole C/L and not to edge of gasket.

Tolerance Range				
FEATURE TYPE	Sample Dim.	0 - 4"	4.1 - 12"	12.1 - 24"
Length/Width	A, B, W	+/- .020	+/- .030	+/- .040
Hole Location	C, F	+/- .010	+/- .015	+/- .020
Hole Diameter	D	+/- .020	+/- .030	+/- .040

PRODUCTS AND LITERATURE

We've Got You Covered

Reliable Board, Enclosure and Cable Shielding Solutions

Leader Tech is a world-leading innovator and US-based manufacturer of EMI shielding products for circuit boards, enclosures and cables. In addition to our best selling standard, modified standard and custom CBS shields, Leader Tech offers an expansive line of beryllium copper fingerstock gaskets, conductive elastomers, advanced RF absorber materials and EMI/RFI ferrites.



CBS Circuit Board Shielding Catalog

FerriShield Ferrite Catalog

TechSIL Conductive Elastomer Catalog

EA EMI Microwave Absorbers Catalog



LeaderTech Shielding Products

Board Level Shielding

- Standard and Multi-Cavity CBS
- Modified Standard Options
- Custom Circuit Board Shields

FerriShield Ferrites

- Snap-On Bisected & Solid Bead Ferrites
- Round & Flat Styles for Cables, Wires and Flex Circuits
- Low, High, Microwave and Wideband Frequency-Specific Material

Enclosure Shielding

- BeCu Fingerstock Gaskets
- TechSIL 5000 Conductive Elastomers
- Conductive Fabric Shielding Gaskets
- TechSIL 8000 Oriented Wire Gaskets
- TechMESH Knitted Wire Gaskets
- TechMESH Combo Strip & Gaskets

**EMI
Problem?**

Our sales engineers are waiting for your call: 866-TECH-EMI (866-832-4364)

Visit our web site today to browse our complete product line, download literature and find your local sales engineer or sales representative!
www.leadertechinc.com