

OSS-O

~45° + 15° oval beam optimized for Osram Golden Dragon+. Assembly with white holder.

SPECIFICATION:

Dimensions	21.6 x 21.6 mm
Height	13.9 mm
Fastening	tape
ROHS compliant	yes ⓘ



MATERIALS:

Component	Type	Material	Colour	Finish
ROSE-A-A-O	Single lens	PC	clear	
ROSE-HLD-A	Holder	PC	white	
ROSE-TAPE	Tape	Acrylic foam	black	

ORDERING INFORMATION:

Component		Qty in box	MOQ	MPQ	Box weight (kg)
FA10302_OSS-O	Single lens	2304	288	144	12.1
» Box size:					

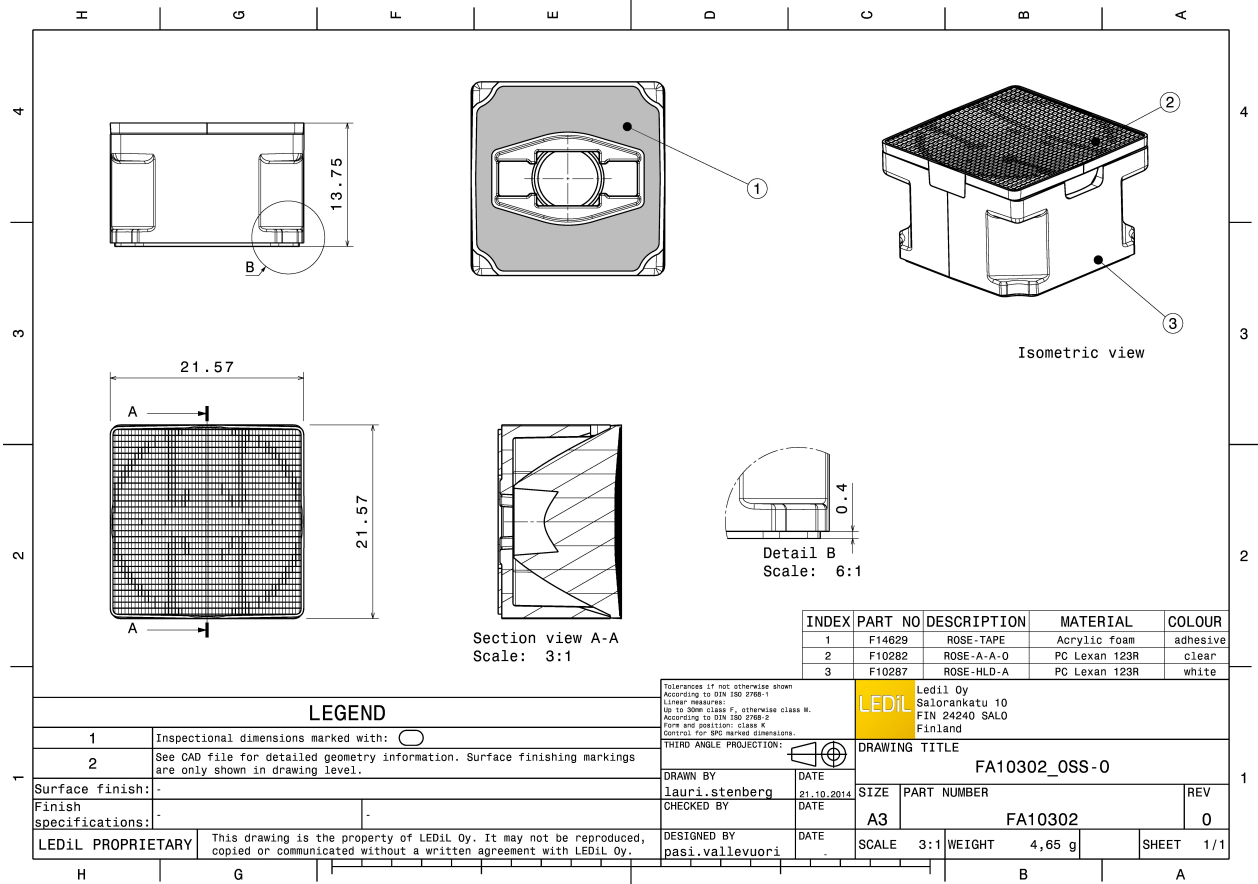

See also our general installation guide: www.ledil.com/installation_guide

OPTICAL RESULTS (MEASURED):

OSRAM
Opto Semiconductors

LED	Golden Dragon+
FWHM / FWTM	42.0 + 11.0° / 69.0 + 22.0°
Efficiency	86 %
Peak intensity	4.2 cd/m
LEDs/each optic	1
Light colour	White
Required components:	

OPTICAL RESULTS (SIMULATED):



LED J Series 5050 Round LES
 FWHM / FWTM 48.0 + 20.0° / 80.0 + 44.0°
 Efficiency 83 %
 Peak intensity 2.1 cd/lm
 LEDs/each optic 1
 Light colour White
 Required components:

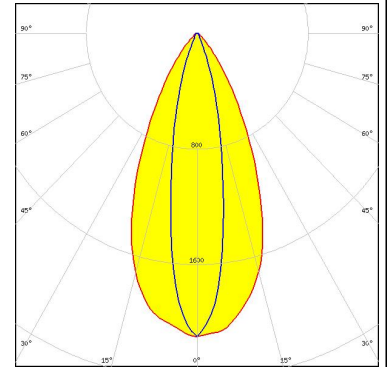

LED MHB-A/B
 FWHM / FWTM 48.0 + 22.0° / 82.0 + 47.0°
 Efficiency 82 %
 Peak intensity 2 cd/lm
 LEDs/each optic 1
 Light colour White
 Required components:



LED MHB-A/B
 FWHM / FWTM 46.0 + 22.0° / 80.0 + 46.0°
 Efficiency 83 %
 Peak intensity 2.1 cd/lm
 LEDs/each optic 1
 Light colour White
 Required components:

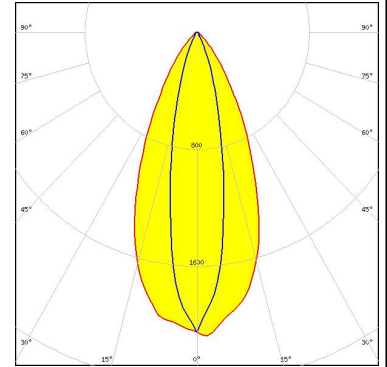

LED MX-3
 FWHM / FWTM 50.0 + 14.0° / 73.0 + 34.0°
 Efficiency 86 %
 Peak intensity 3.1 cd/lm
 LEDs/each optic 1
 Light colour White
 Required components:

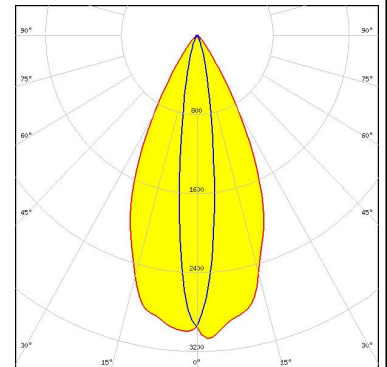

OPTICAL RESULTS (SIMULATED):



LED MX-6
 FWHM / FWTM 44.0 + 16.0° / 76.0 + 38.0°
 Efficiency 85 %
 Peak intensity 2.8 cd/lm
 LEDs/each optic 1
 Light colour White
 Required components:

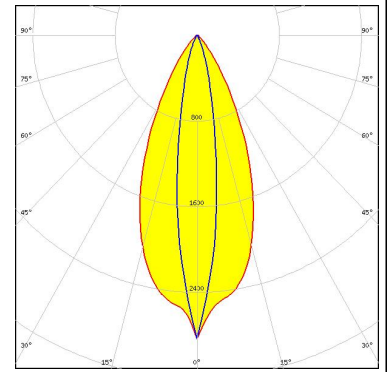

LED LUXEON 5050 Round LES
 FWHM / FWTM 46.0 + 20.0° / 79.0 + 44.0°
 Efficiency 82 %
 Peak intensity 2.2 cd/lm
 LEDs/each optic 1
 Light colour White
 Required components:

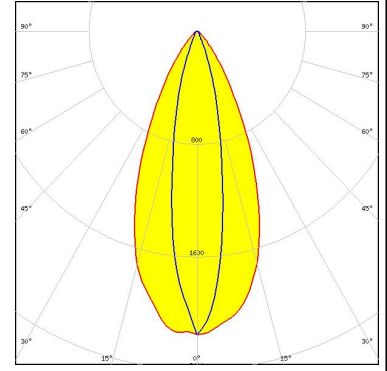

LED NS6x83
 FWHM / FWTM 47.0 + 16.0° / 75.0 + 35.0°
 Efficiency 84 %
 Peak intensity 2.8 cd/lm
 LEDs/each optic 1
 Light colour White
 Required components:

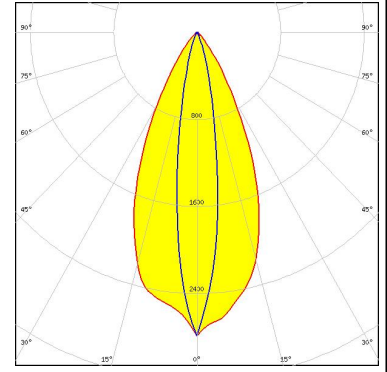

LED OSOLON Square EC
 FWHM / FWTM 12.0 + 50.0° / 24.0 + 72.0°
 Efficiency 85 %
 Peak intensity 3.8 cd/lm
 LEDs/each optic 1
 Light colour White
 Required components:

