

Linear LED Drivers with Single-Wire Digital Interface

FAN5622, FAN5624, FAN5626

Description

The FAN5622, FAN5624, and FAN5626 are two-, four-, and six-channel current-sink linear LED drivers used to backlight the main LCD displays or keypads in mobile electronics, such as cellular phone handsets.

A very low dropout of 50 mV allows driving LEDs without any inductors or switch capacitors. The brightness levels of the LED outputs are programmed through single-wire digital control interface. The user can program 32 linear dimming steps and turn on and off the LEDs through this interface by applying digital pulses.

The FAN562x family of linear LED drivers provides high efficiency due to the low drop-out voltage of the LED driver. Good matching between different channels of LED output is provided across the entire 32 dimming steps. These LED drivers also integrate short circuit, under-voltage, and thermal protection to ensure for a more robust solution.

The FAN5622, FAN5624, and FAN5626 are available in very small form-factor packages: 6-pin Super SOT23, 10-lead UMLP, and 10-lead MicroPak™ MLP, respectively.

Features

- Family of Three Linear Current-Sink LED Drivers that Support 2, 4, or 6 LED Outputs
- Current Sink Driver for Each LED Output:
 - ◆ 30 mA Maximum Output Current
 - ◆ 50 mV Drop-out at 15 mA I_{OUT}
 - ◆ Better than 3% Matching between Channels
 - ◆ External R_{SET}
- Single-Wire Digital Control Interface for Easy Programming
 - ◆ 32 Linear Steps of Dimming Control
- Less than 1 μ A Shutdown Current
- Short-Circuit, Under-Voltage, and Thermal Protection
- Wide Input Voltage Range: 2.7 to 5.5 V
- Small Form-Factor Packages:
- These are Pb-Free Devices
 - ◆ FAN5622: 6-Pin Super SOT23
 - ◆ FAN5624: 10-Lead 1.4x1.8x0.55 mm UMLP
 - ◆ FAN5626: 10-Lead 1.6x2.1x0.55 mm MicroPak MLP

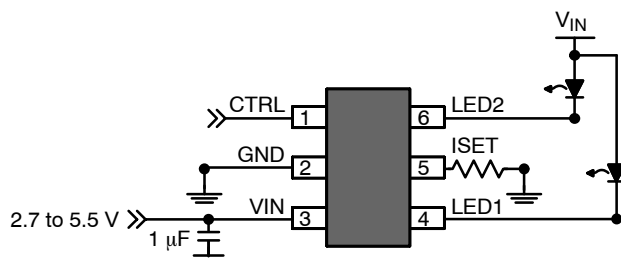

Figure 1. Typical Application of FAN5622



ON Semiconductor®

www.onsemi.com

| | | MARKING DIAGRAM |
|--|---|-----------------|
| | TSOT23 6-Lead CASE 419BL | |
| | UQFN10 1.4x1.8, 0.4P CASE 523BC | |
| | UQFN10 (MICROPAK), 1.6X2.1, 0.5P CASE 523AZ | |

622, 24, 26 = Specific Device Code
 &Y = Binary Calendar Year Coding Scheme
 &O = Plant Code Identifier
 &C = Single Digit Die Run Code
 &V = Eight-Week Binary Datacoding Scheme
 &K = 2-Digits Lot Run Traceability Code
 &2 = 2-Digit Date Code
 &Z = Assembly Plant Code

ORDERING INFORMATION

See detailed ordering and shipping information on page 9 of this data sheet.

Applications

- Mobile Handsets
- Mobile Internet Devices
- PMP and MP3 Players
- LCD Modules

FAN5622, FAN5624, FAN5626

APPLICATIONS DIAGRAMS

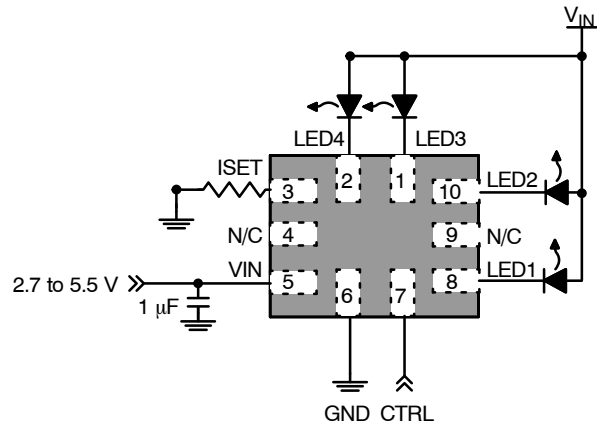

Figure 2. FAN5624 Typical Application for 4 LEDs

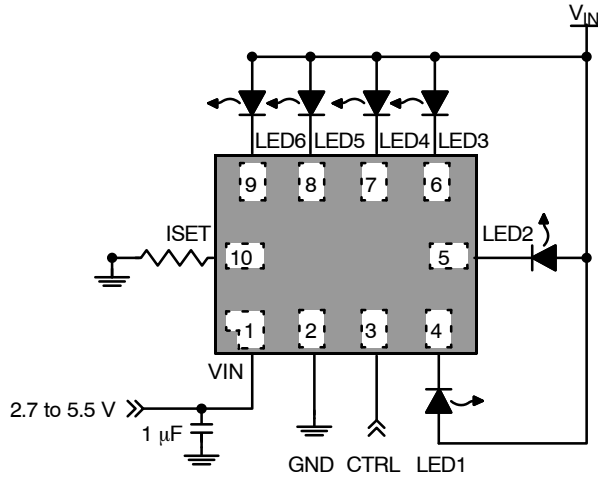

Figure 3. FAN5626 Typical Application for 6 LEDs

BLOCK DIAGRAM

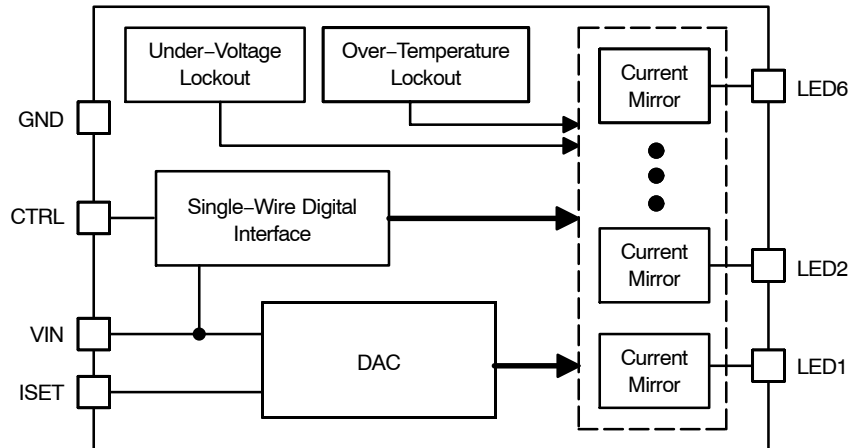

Figure 4. Block Diagram

FAN5622, FAN5624, FAN5626

PIN CONFIGURATION

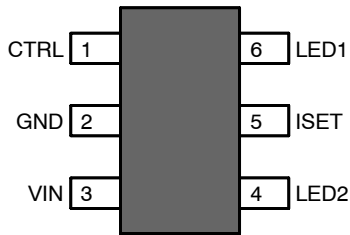

Figure 5. FAN5622: 6-Pin SSOT23, Top View

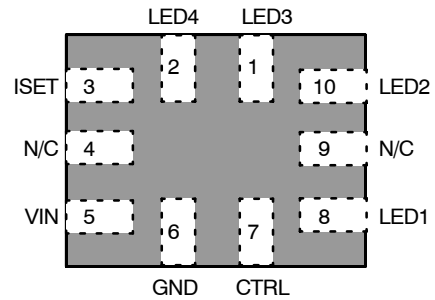

Figure 6. FAN5624: 10-Lead UMLP, Top View

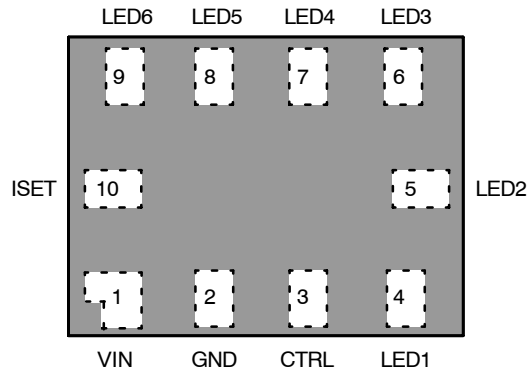

Figure 7. FAN5626: 10-Lead MicroPak MLP, Top View

PIN DEFINITIONS

| Pin No. | | | Name | Description |
|---------------------|-------------------|------------------------------|------|--|
| FAN5622 SSOT23-6 | FAN5624 UMLP10 | FAN5626 MicroPak MLP10 | | |
| 3 | 5 | 1 | VIN | <i>Input Voltage.</i> Connect to 2.7 – 5.5 V _{DC} input power source. |
| 2 | 6 | 2 | GND | <i>Ground</i> |
| 5 | 3 | 10 | ISET | <i>LED Current Setting.</i> Full-scale LED current is set by tying this pin through a resistor (R _{SET}) to GND. |
| 1 | 7 | 3 | CTRL | <i>Control pin.</i> Program dimming levels by driving pin with digital pulses. This pin cannot be left floating. |
| 6 | 8 | 4 | LED1 | <i>LED Cathode #1.</i> LED current sink output. |
| 4 | 10 | 5 | LED2 | <i>LED Cathode #2.</i> LED current sink output. |
| | 1 | 6 | LED3 | <i>LED Cathode #3.</i> LED current sink output. |
| | 2 | 7 | LED4 | <i>LED Cathode #4.</i> LED current sink output. |
| | | 8 | LED5 | <i>LED Cathode #5.</i> LED current sink output. |
| | | 9 | LED6 | <i>LED Cathode #6.</i> LED current sink output. |
| | 4, 9 | | N/C | <i>No Connect</i> |

FAN5622, FAN5624, FAN5626

ABSOLUTE MAXIMUM RATINGS

| Symbol | Parameter | Min | Max | Unit |
|------------------|--|--------------------------------------|-----------------------|------|
| V _{CC} | VIN Pin | -0.3 | 6.0 | V |
| | Other Pins (Note 1) | -0.3 | V _{IN} + 0.3 | V |
| ESD | Electrostatic Discharge Protection Level | Human Body Model per JESD22-A114 | 3.0 | kV |
| | | Charged Device Model per JESD22-C101 | 1.5 | kV |
| T _J | Junction Temperature | -40 | +150 | °C |
| T _{STG} | Storage Temperature | -65 | +150 | °C |
| T _L | Lead Soldering Temperature, 10 Seconds | - | +260 | °C |

Stresses exceeding those listed in the Maximum Ratings table may damage the device. If any of these limits are exceeded, device functionality should not be assumed, damage may occur and reliability may be affected.

1. Lesser of 6.0 V or V_{IN} + 0.3 V.

RECOMMENDED OPERATING CONDITIONS

| Symbol | Parameter | Min | Max | Unit |
|----------------------|--------------------------------------|-----|------|------|
| V _{IN} | Power Supply Voltage Range | 2.7 | 5.5 | V |
| T _A | Operating Ambient Temperature Range | -40 | +85 | °C |
| T _J | Operating Junction Temperature Range | -40 | +125 | °C |
| I _{LED(FS)} | Full-Scale LED Current | 5 | 30 | mA |

Functional operation above the stresses listed in the Recommended Operating Ranges is not implied. Extended exposure to stresses beyond the Recommended Operating Ranges limits may affect device reliability.

THERMAL PROPERTIES (Junction-to-ambient thermal resistance is a function of application and board layout. This data is measured with boards in accordance to JEDEC standard JESD51. Special attention must be paid not to exceed junction temperature T_{J(max)} at a given ambient temperature T_A.)

| Symbol | Parameter | Typical | Unit |
|-----------------|---|---------|------|
| θ _{JA} | Junction-to-Ambient Thermal Resistance, SSOT23-6 Package | 235 | °C/W |
| | Junction-to-Ambient Thermal Resistance, UMLP10 Package (Note 2) | 287 | °C/W |
| | Junction-to-Ambient Thermal Resistance, MicroPak MLP10 package (Note 3) | 220 | °C/W |

2. Recommended not to exceed 132 mW of maximum power dissipation.

3. Recommended not to exceed 198 mW of maximum power dissipation.

FAN5622, FAN5624, FAN5626

ELECTRICAL SPECIFICATIONS ($V_{IN} = 2.7\text{ V to }5.5\text{ V}$, $R_{SET} = 19.10\text{ k}\Omega$, $T_A = -40^\circ\text{C to }+85^\circ\text{C}$, $V_f = 2.5\text{ V to }[3.5\text{ V or }V_{IN} - 0.1\text{ V}]$, whichever is smaller. Typical values are at $T_A = 25^\circ\text{C}$, $V_{IN} = 3.6\text{ V}$, and $V_f = 3.2\text{ V}$.)

| Symbol | Parameter | Condition | Min | Typ | Max | Unit |
|-----------------------|---------------------------------|--|------|------|------|---------------|
| POWER SUPPLIES | | | | | | |
| I_{SD} | Shutdown Supply Current | $V_{IN} = 3.6\text{ V}$, CTRL = 0 | – | 0.3 | 1.0 | μA |
| I_{IN} | Operating Supply Current | FAN5622: $V_{IN} = 3.6\text{ V}$, $I_{LED} = 0\text{ mA}$ | – | 0.4 | 0.8 | mA |
| | | FAN5624: $V_{IN} = 3.6\text{ V}$, $I_{LED} = 0\text{ mA}$ | – | 0.6 | 1.0 | mA |
| | | FAN5626: $V_{IN} = 3.6\text{ V}$, $I_{LED} = 0\text{ mA}$ | – | 0.8 | 1.2 | mA |
| I_{IH} | Control Pin Input Current | CTRL = 1.8 V | – | 1 | 250 | nA |
| V_{UVLO} | Under-Voltage Lockout Threshold | V_{IN} Rising | – | 2.50 | 2.70 | V |
| | | V_{IN} Falling | 2.10 | 2.30 | 2.50 | V |

REGULATION

| | | | | | | |
|------------------------|------------------------------------|---|-----|------|-----|------------------|
| $I_{FS_LEDX (MAX)}$ | Full-Scale LED Output Current | $I_{LEDx} = 30\text{ mA}$; x = 1 to 6 | 5 | – | 30 | mA |
| I_{LED} | Absolute Current Accuracy | $V_{IN} = 2.85\text{ V} - 4.5\text{ V}$; $V_{CATH} = 0.15$ to (1.2 V or $V_{IN} = 2.55\text{ V}$, Whichever is Smaller); Full-Scale Current 5 – 30 mA, $T_A = 25^\circ\text{C}$ | –10 | – | +10 | % |
| $I_{LED\ MATCH}$ | LED Current Matching (Note 4) | $I_{LEDx} = 15\text{ mA}$; $V_{LEDx} = 0.4\text{ V}$, $T_A = 25^\circ\text{C}$ | –3 | – | +3 | % |
| V_{ISET} | I_{SET} Drive Voltage | $9.53\text{ k}\Omega \leq R_{SET} \leq 56.2\text{ k}\Omega$ | – | 1.20 | – | V |
| I_{RATIO} | Current Mirror Ratio from ISET Pin | $9.53\text{ k}\Omega \leq R_{SET} \leq 56.2\text{ k}\Omega$ | – | 240 | – | |
| ΔI_{OUT_LOAD} | I_{OUT} Load Regulation | $V_{IN} = 3.6\text{ V}$, $I_{LEDx} = 15\text{ mA}$, LED $V_f = 2.7$ to 3.5 V | –3 | – | +3 | % |
| ΔI_{OUT_LINE} | I_{OUT} Line Regulation | $V_{IN} = 2.7$ to 4.8 V , $I_{LEDx} = 15\text{ mA}$, $V_{CATH} = 0.5\text{ V}$ | –4 | – | +4 | % |
| $V_{DROPOUT}$ | Dropout Voltage | $V_{IN} = 3.6\text{ V}$; $I_{LED} = 15\text{ mA}$, –10% I_{LED} Drop | – | 50 | – | mV |
| | | $V_{IN} = 3.6\text{ V}$; $I_{LED} = 30\text{ mA}$, –10% I_{LED} Drop | – | 60 | – | |
| TSD | Thermal Shutdown | Rising Temperature at Junction | – | 150 | – | $^\circ\text{C}$ |
| | | Hysteresis | – | 20 | – | |

LOGIC INPUT (CTRL)

| | | | | | | |
|----------|--------------------------------|---|-----|-----|-----|---------------|
| V_{IH} | HIGH-Level Input Voltage | | 1.2 | – | – | V |
| V_{IL} | LOW-Level Input Voltage | | – | – | 0.4 | V |
| T_{LO} | CTRL LOW Time for Dimming | $V_{IN} = 3.6\text{ V}$; See Figure 17 | 0.5 | – | 300 | μs |
| T_{HI} | Time Delay between Steps | $V_{IN} = 3.6\text{ V}$; See Figure 17 | 0.5 | – | – | μs |
| T_{ON} | CTRL HIGH to Turn-On Delay | $V_{IN} = 3.6\text{ V}$; See Figure 17 | – | 250 | – | μs |
| T_{SD} | CTRL LOW, Shutdown Pulse Width | $V_{IN} = 3.6\text{ V}$; from Falling Edge of CTRL | 1 | – | – | ms |

Product parametric performance is indicated in the Electrical Characteristics for the listed test conditions, unless otherwise noted. Product performance may not be indicated by the Electrical Characteristics if operated under different conditions.

4. For the two, four, and six LED current sinks of FAN5622, FAN5624, and FAN5626 respectively; the following are determined: the maximum sink current of the two, four, and six LED outputs (MAX); the minimum sink current of the two, four, and six outputs (MIN); and the average sink current (AVG). For all of the LED outputs, two matching numbers are calculated: $(MAX - AVG) / AVG$ and $(AVG - MIN) / AVG$. The largest number of the two (worst case) is considered the matching figure for the part. The matching figure for a given part is considered to be the highest matching figure of all LED outputs. The typical specification provided is the most likely norm of the matching figure for all parts.

TYPICAL PERFORMANCE CHARACTERISTICS

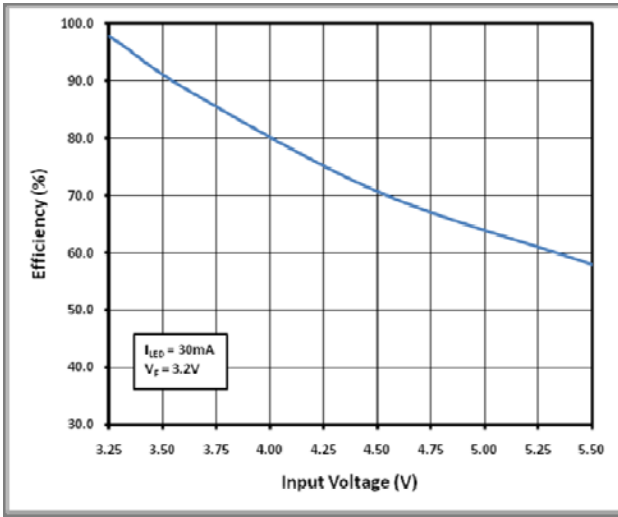

Figure 8. Efficiency vs. Input Voltage where LED $V_F = 3.2V$

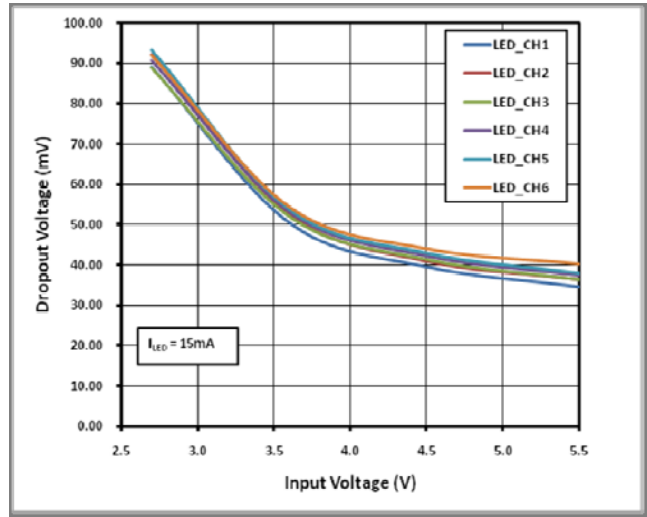

Figure 9. Dropout Voltage vs. Input Voltage

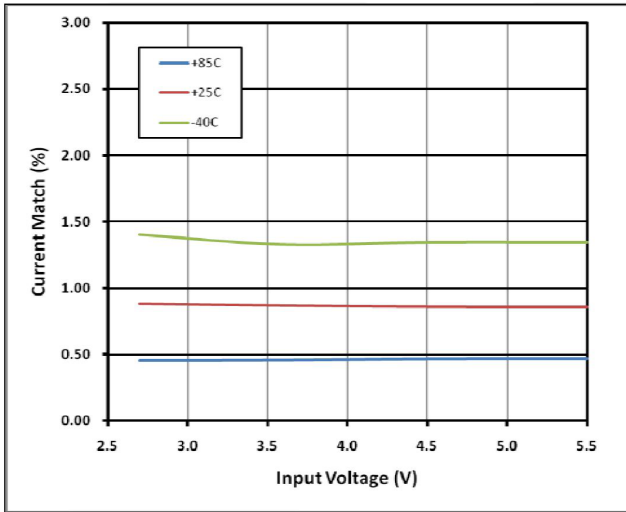

Figure 10. Current Match of Channels vs. Input Voltage

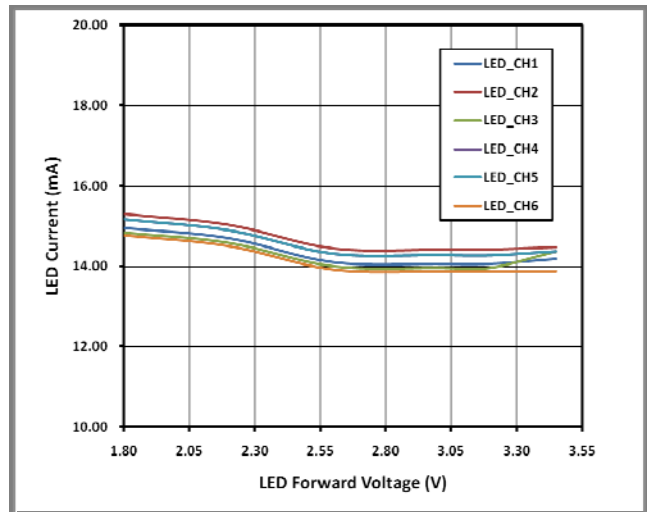

Figure 11. Load Regulation at 15 mA/Output

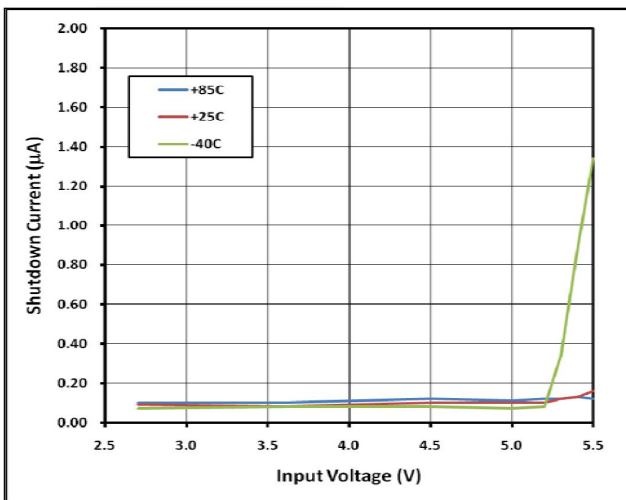

Figure 12. Shutdown Current vs. Input Voltage

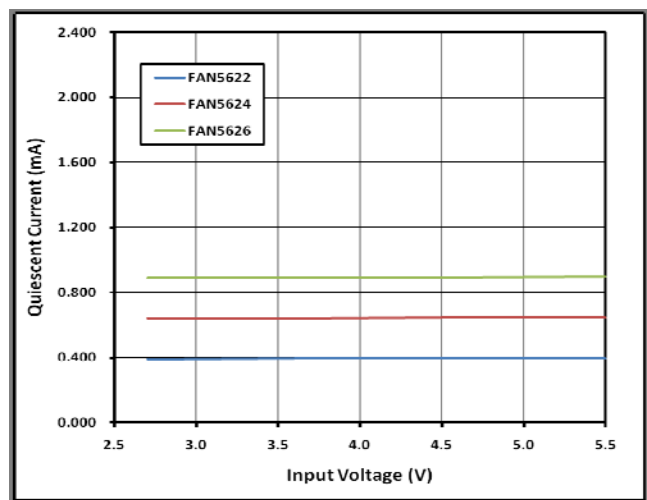

Figure 13. Quiescent Current vs. Input Voltage

FAN5622, FAN5624, FAN5626

TYPICAL PERFORMANCE CHARACTERISTICS (Continued)

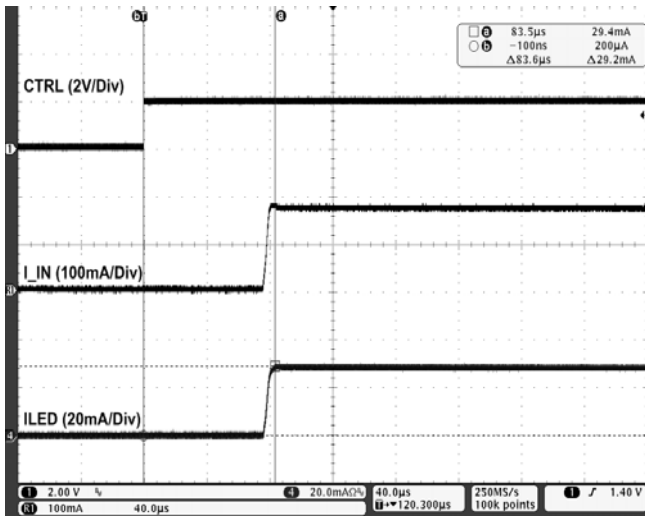

Figure 14. Startup Waveform for FAN5626

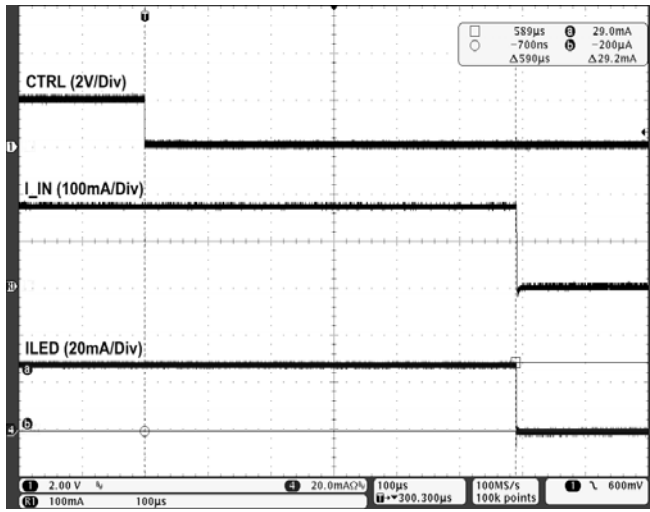

Figure 15. Shutdown Waveform for FAN5626

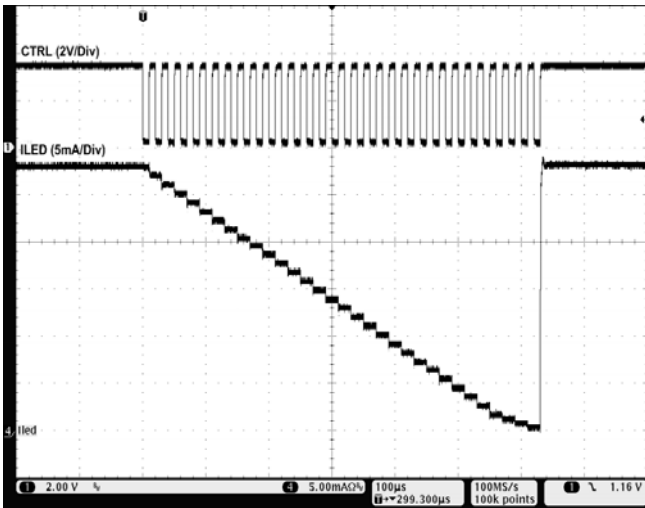

Figure 16. Dimming Operation

CIRCUIT DESCRIPTION

The FAN5622, FAN5624, and FAN5626 are a family of current-sink linear LED driver ICs able to drive two, four, and six LEDs respectively. These three devices are powered directly from 2.7 V to 5.5 V supply and all the channels are controlled via the integrated current sinks from the external power source. Designed with a very low drop-out voltage, the FAN562x products can operate close to the input supply voltage without the need for additional inductive boost or capacitive switching circuitry.

All three devices require only two additional discrete passive components: a single 1 μ F input ceramic capacitor and a resistor (R_{SET}) to set the maximum current for the LEDs. Each current-sink output provides constant current and can drive the LEDs up to 30 mA. ON Semiconductor’s TinyWire single-wire digital interface enables these LED drivers to program the brightness level of the LEDs in 32 linear steps.

Setting Maximum Current

The maximum LED current of the FAN5622, FAN5624, and FAN5626 is programmed by an external resistor called RSET. The maximum full-scale LED current for all three LED drivers is 30 mA and it can go as low as 5 mA. The FAN562x products also operate below 5 mA full-scale LED current by using a larger RSET value. However, the LED channel accuracy and matching specifications are guaranteed. Table 1 shows the RSET resistor values for several full-scale current levels.

Table 1. MAXIMUM LED CURRENT SETTINGS BY RESISTOR

| I_{LED} (mA) | R_{SET} (k Ω) |
|----------------|-------------------------|
| 5 | 56.20 |
| 10 | 28.70 |
| 15 | 19.10 |
| 20 | 14.30 |
| 25 | 11.50 |
| 30 | 9.53 |

Digital Interface & Dimming Control

The FAN5622, FAN5624, and FAN5626 implement a simple single-wire digital interface to program the LED brightness to one of thirty two (32) levels spaced in linear steps. To maintain the brightness of the LEDs at a specific dimming level, the digital pulse signal to the CTRL pin should be held HIGH for that last pulse. It is held HIGH for as long as desired to keep the LEDs illuminated at that specific brightness level.

Table 2 outlines the dimming levels while Figure 17 shows how to change the dimming levels.

Table 2. BRIGHTNESS CONTROL LEVELS ($R_{SET} = 19.10$ k Ω)

| Dimming Level | Current Level | I_{LED} (mA) |
|---------------|---------------|----------------|
| 1 | 1.67% | 0.25 |
| 2 | 3.33% | 0.50 |
| 3 | 5.00% | 0.75 |
| 4 | 6.67% | 1.00 |
| 5 | 10.00% | 1.50 |
| 6 | 13.33% | 2.00 |
| 7 | 16.67% | 2.50 |
| 8 | 20.00% | 3.00 |
| 9 | 23.33% | 3.50 |
| 10 | 26.67% | 4.00 |
| 11 | 30.00% | 4.50 |
| 12 | 33.33% | 5.00 |
| 13 | 36.67% | 5.50 |
| 14 | 40.00% | 6.00 |
| 15 | 43.33% | 6.50 |
| 16 | 46.67% | 7.00 |
| 17 | 50.00% | 7.50 |
| 18 | 53.33% | 8.00 |
| 19 | 56.67% | 8.50 |
| 20 | 60.00% | 9.00 |
| 21 | 63.33% | 9.50 |
| 22 | 66.67% | 10.00 |
| 23 | 70.00% | 10.50 |
| 24 | 73.33% | 11.00 |
| 25 | 76.67% | 11.50 |
| 26 | 80.00% | 12.00 |
| 27 | 83.33% | 12.50 |
| 28 | 86.67% | 13.00 |
| 29 | 90.00% | 13.50 |
| 30 | 93.33% | 14.00 |
| 31 | 96.67% | 14.50 |
| 32 | 100.00% | 15.00 |

FAN5622, FAN5624, FAN5626

Digital Dimming Control

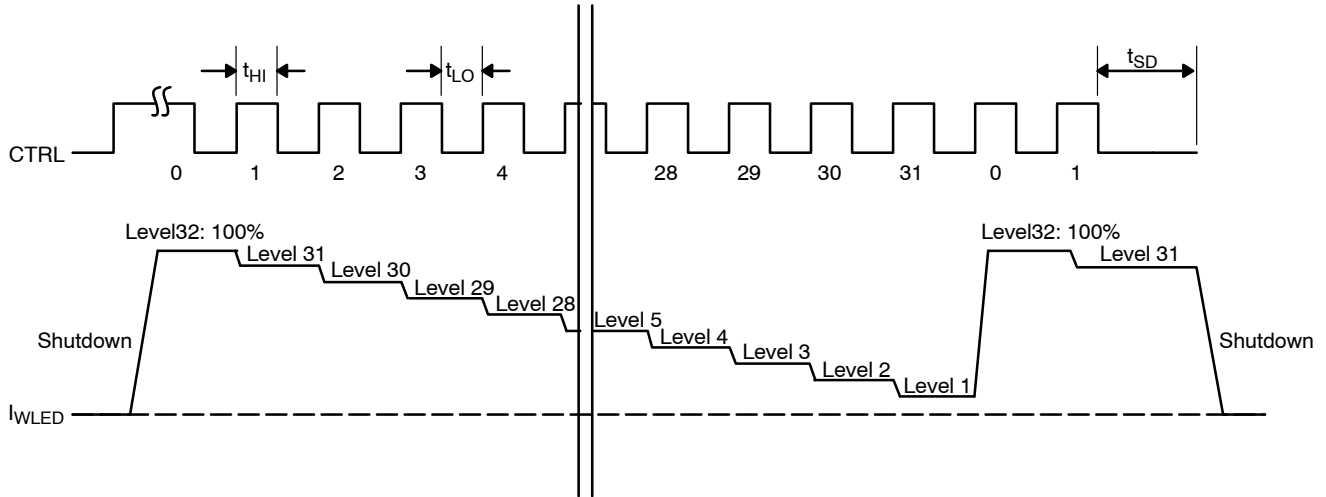

Figure 17. Digital Pulse Dimming Control Diagram

ORDERING INFORMATION

| Part Number | # of Channels | Temperature Range | Package | Shipping† |
|-------------|---------------|-------------------|---|--------------------|
| FAN5622SX | 2 | -40 to 85°C | 6-Lead, SUPERSOT™ 6, JEDEC MO-193, 1.6 mm Wide (Pb-Free) | 3000 / Tape & Reel |
| FAN5624UMPX | 4 | -40 to 85°C | 10-Lead, Ultrathin Molded Leadless Package (UMLP) (Pb-Free) | 5000 / Tape & Reel |
| FAN5626LX | 6 | -40 to 85°C | 10-Lead, MicroPak, JEDEC MO255, 1.6 X 2.1 mm (Pb-Free) | 5000 / Tape & Reel |

†For information on tape and reel specifications, including part orientation and tape sizes, please refer to our Tape and Reel Packaging Specifications Brochure, BRD8011/D.

MicroPak and SUPERSOT are trademarks of Semiconductor Components Industries, LLC (SCILLC) or its subsidiaries in the United States and/or other countries.

MECHANICAL CASE OUTLINE

PACKAGE DIMENSIONS

ON Semiconductor®



SCALE 2:1

TSOT23 6-Lead CASE 419BL ISSUE A

DATE 31 AUG 2020

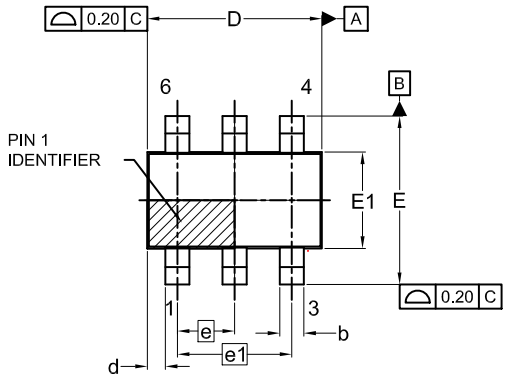

TOP VIEW



FRONT VIEW



DETAIL A

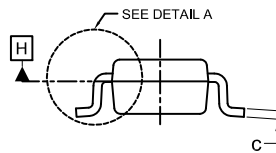

SIDE VIEW

SYMM
⌀

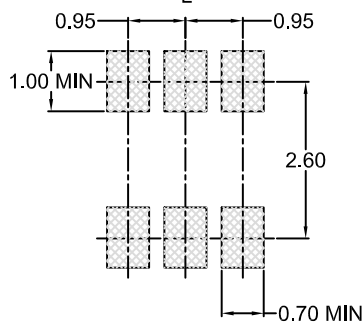

LAND PATTERN
RECOMMENDATION

*FOR ADDITIONAL INFORMATION ON OUR Pb-FREE STRATEGY AND SOLDERING DETAILS, PLEASE DOWNLOAD THE ON SEMICONDUCTOR SOLDERING AND MOUNTING TECHNIQUES REFERENCE MANUAL, SOLDERRM/D.

NOTES:

1. DIMENSIONING AND TOLERANCING PER ASME Y14.5M, 2009.
2. CONTROLLING DIMENSION: MILLIMETERS
3. DIMENSIONS D AND E1 DO NOT INCLUDE MOLD FLASH, PROTRUSIONS, OR GATE BURRS. MOLD FLASH, PROTRUSIONS OR GATE BURRS SHALL NOT EXCEED 0.25MM PER END. DIMENSIONS D AND E1 ARE DETERMINED AT DATUM H.
4. SEATING PLANE IS DEFINED BY THE TERMINALS. "A1" IS DEFINED AS THE DISTANCE FROM THE SEATING PLANE TO THE LOWEST POINT ON THE PACKAGE BODY.

| DIM | MILLIMETERS | | |
|-----|-------------|------|------|
| | MIN. | NOM. | MAX. |
| A | 0.90 | 1.00 | 1.10 |
| A1 | 0.00 | 0.05 | 0.10 |
| A2 | 0.70 | 0.85 | 1.00 |
| A3 | 0.25 BSC | | |
| b | 0.25 | 0.38 | 0.50 |
| c | 0.10 | 0.18 | 0.26 |
| D | 2.80 | 2.95 | 3.10 |
| d | 0.30 REF | | |
| E | 2.50 | 2.75 | 3.00 |
| E1 | 1.30 | 1.50 | 1.70 |
| e | 0.95 BSC | | |
| e1 | 1.90 BSC | | |
| L1 | 0.60 REF | | |
| L2 | 0.20 | 0.40 | 0.60 |
| ⌀ | 0° | -- | 10° |

GENERIC MARKING DIAGRAM*



XXX = Specific Device Code
M = Date Code
▪ = Pb-Free Package

(Note: Microdot may be in either location)

*This information is generic. Please refer to device data sheet for actual part marking. Pb-Free indicator, "G" or microdot "▪", may or may not be present. Some products may not follow the Generic Marking.

| | | |
|-------------------------|----------------------|--|
| DOCUMENT NUMBER: | 98AON83292G | Electronic versions are uncontrolled except when accessed directly from the Document Repository. Printed versions are uncontrolled except when stamped "CONTROLLED COPY" in red. |
| DESCRIPTION: | TSOT23 6-Lead | PAGE 1 OF 1 |

ON Semiconductor and ON are trademarks of Semiconductor Components Industries, LLC dba ON Semiconductor or its subsidiaries in the United States and/or other countries. ON Semiconductor reserves the right to make changes without further notice to any products herein. ON Semiconductor makes no warranty, representation or guarantee regarding the suitability of its products for any particular purpose, nor does ON Semiconductor assume any liability arising out of the application or use of any product or circuit, and specifically disclaims any and all liability, including without limitation special, consequential or incidental damages. ON Semiconductor does not convey any license under its patent rights nor the rights of others.

MECHANICAL CASE OUTLINE

PACKAGE DIMENSIONS

ON Semiconductor®

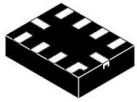

UQFN10 (MICROPAK™), 1.6X2.1, 0.5P CASE 523AZ ISSUE A

DATE 11 DEC 2019

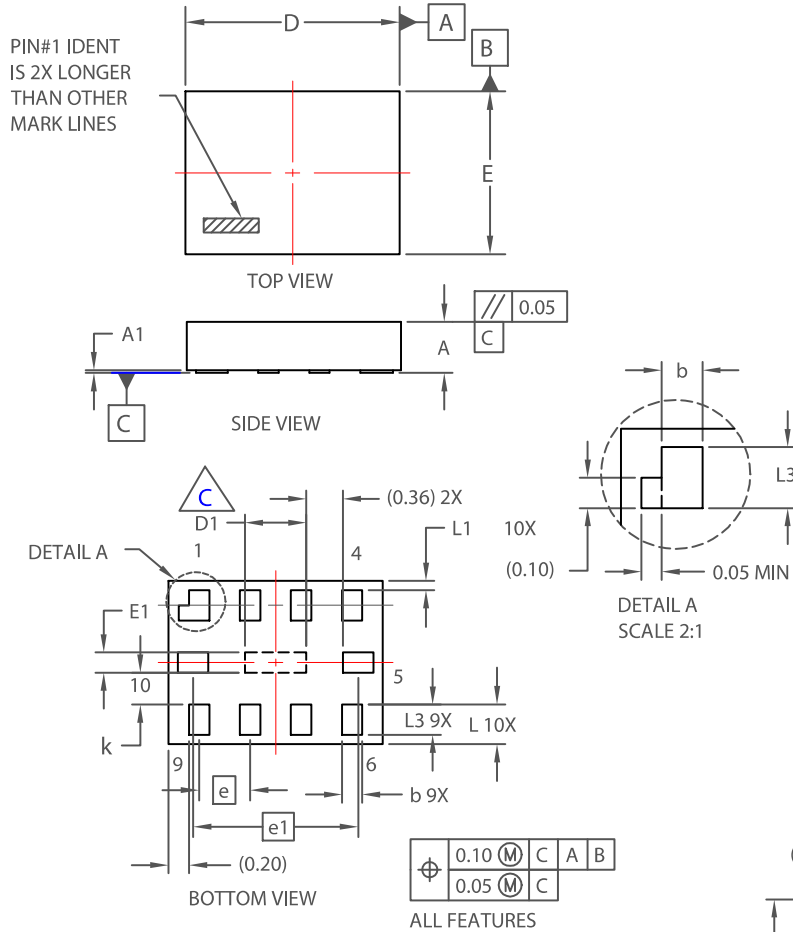

NOTES:

- A. PACKAGE CONFORMS TO JEDEC REGISTRATION MO-255, VARIATION UABD.
- B. DIMENSIONS ARE IN MILLIMETERS.
- C. PRESENCE OF CENTER PAD IS PACKAGE SUPPLIER DEPENDENT. IF PRESENT IT IS NOT INTENDED TO BE SOLDERED AND HAS A BLACK OXIDE FINISH.
- D. DIMENSIONS WITHIN () ARE UNCONTROLLED.

| DIM | MIN. | NOM. | MAX. |
|-----|----------|-------|------|
| A | 0.50 | 0.55 | 0.65 |
| A1 | 0.00 | 0.025 | 0.05 |
| b | 0.15 | 0.20 | 0.25 |
| D | 2.00 | 2.10 | 2.20 |
| D1 | 0.55 | 0.60 | 0.65 |
| E | 1.50 | 1.60 | 1.70 |
| E1 | 0.15 | 0.20 | 0.25 |
| e | 0.50 BSC | | |
| e1 | 1.62 BSC | | |
| k | 0.20 | -- | -- |
| L | 0.25 | 0.30 | 0.42 |
| L1 | 0.00 | 0.09 | 0.15 |
| L3 | 0.25 | 0.30 | 0.35 |

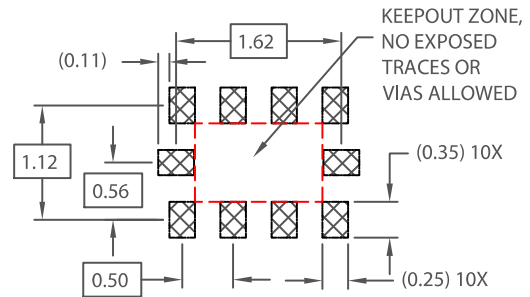

RECOMMENDED MOUNTING FOOTPRINT*

*FOR ADDITIONAL INFORMATION ON OUR Pb-FREE STRATEGY AND SOLDERING DETAILS, PLEASE DOWNLOAD THE ON SEMICONDUCTOR SOLDERING AND MOUNTING TECHNIQUES REFERENCE MANUAL, SOLDERRM/D.

| | | |
|------------------|-----------------------------------|--|
| DOCUMENT NUMBER: | 98AON13592G | Electronic versions are uncontrolled except when accessed directly from the Document Repository. Printed versions are uncontrolled except when stamped "CONTROLLED COPY" in red. |
| DESCRIPTION: | UQFN10 (MICROPAK™), 1.6X2.1, 0.5P | PAGE 1 OF 1 |

ON Semiconductor and ON are trademarks of Semiconductor Components Industries, LLC dba ON Semiconductor or its subsidiaries in the United States and/or other countries. ON Semiconductor reserves the right to make changes without further notice to any products herein. ON Semiconductor makes no warranty, representation or guarantee regarding the suitability of its products for any particular purpose, nor does ON Semiconductor assume any liability arising out of the application or use of any product or circuit, and specifically disclaims any and all liability, including without limitation special, consequential or incidental damages. ON Semiconductor does not convey any license under its patent rights nor the rights of others.



UQFN10 1.4x1.8, 0.4P
CASE 523BC
ISSUE O

DATE 31 OCT 2016

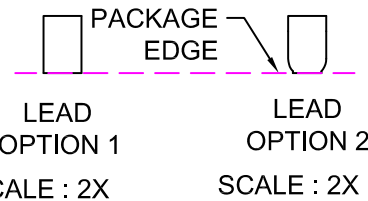
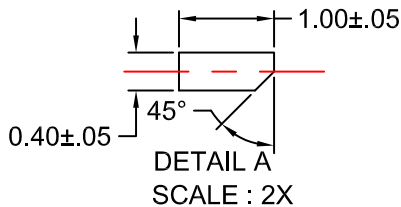
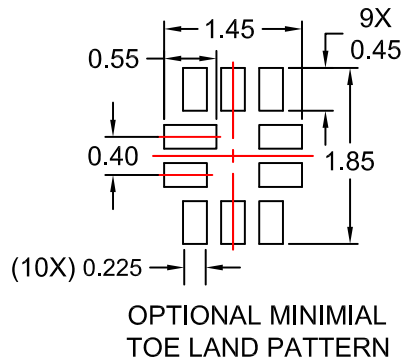
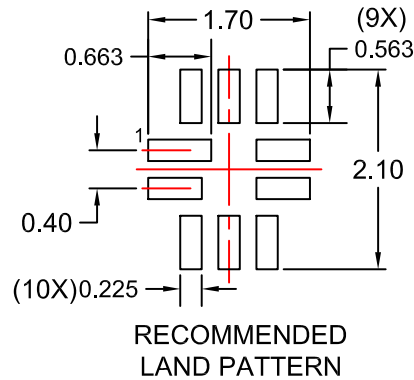
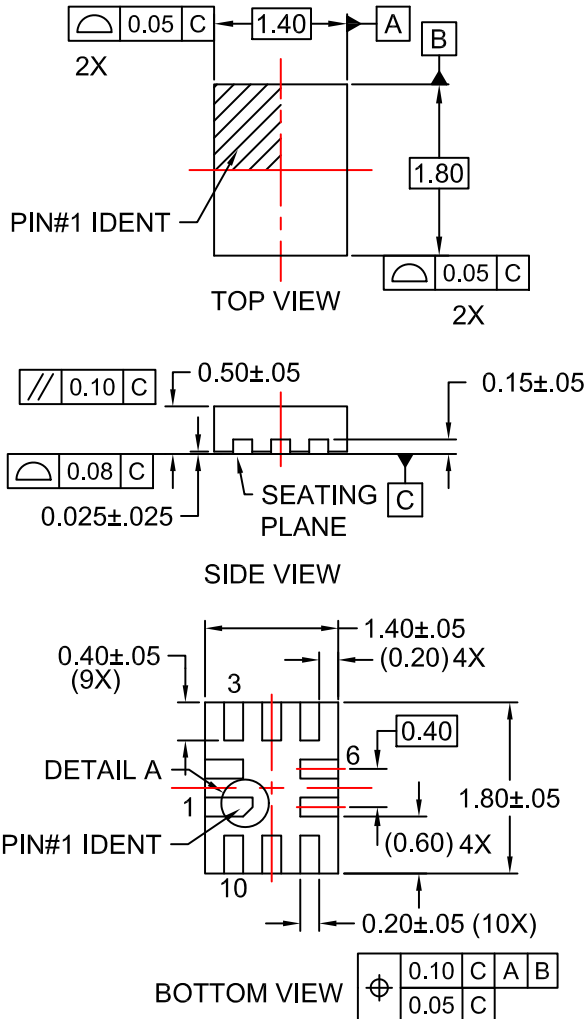

NOTES:

- A. PACKAGE DOES NOT CONFORM TO ANY JEDEC STANDARD.
- B. DIMENSIONS ARE IN MILLIMETERS.
- C. DIMENSIONS AND TOLERANCES PER ASME Y14.5M, 2009.
- D. LAND PATTERN RECOMMENDATION IS EXISTING INDUSTRY LAND PATTERN.

| | | |
|-------------------------|-----------------------------|--|
| DOCUMENT NUMBER: | 98AON13705G | Electronic versions are uncontrolled except when accessed directly from the Document Repository. Printed versions are uncontrolled except when stamped "CONTROLLED COPY" in red. |
| DESCRIPTION: | UQFN10 1.4x1.8, 0.4P | PAGE 1 OF 1 |

ON Semiconductor and are trademarks of Semiconductor Components Industries, LLC dba ON Semiconductor or its subsidiaries in the United States and/or other countries. ON Semiconductor reserves the right to make changes without further notice to any products herein. ON Semiconductor makes no warranty, representation or guarantee regarding the suitability of its products for any particular purpose, nor does ON Semiconductor assume any liability arising out of the application or use of any product or circuit, and specifically disclaims any and all liability, including without limitation special, consequential or incidental damages. ON Semiconductor does not convey any license under its patent rights nor the rights of others.