

# Half-Bridge Gate Driver

## FAN7380-OP

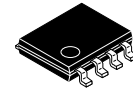

SOIC8  
 (8-SOP)  
 CASE 751EG

### Description

The FAN7380-OP is a monolithic half-bridge gate-drive IC for MOSFETs and IGBTs that operate up to +600 V. onsemi's high-voltage process and common-mode noise cancelling technique provide stable operation of high-side driver under high-dv/dt noise circumstances. An advanced level-shift circuit allows high-side gate driver operation up to  $V_S = -9.8$  V (typical) for  $V_{BS} = 15$  V. The input logic level is compatible with standard TTL-series logic gates. The internal shoot-through protection circuit provides 100 ns dead-time to prevent output switching devices from both conducting during transition periods. UVLO circuits for both channels prevent malfunction when  $V_{CC}$  and  $V_{BS}$  are lower than the specified threshold voltage. Output drivers typically source / sink at 90 mA / 180 mA, respectively, which is suitable for fluorescent / compact fluorescent lamp ballast applications and systems requiring low di/dt noise.

### Features

- Floating Channel Designed for Bootstrapping Operation to +600 V
- Typically 90 mA / 180 mA Sourcing/Sinking Current Driving Capability for Both Channels
- Common-Mode dv/dt Noise Cancelling Circuit
- Extended Allowable Negative  $V_S$  Swing to -9.8 V for Signal Propagation at  $V_{CC} = V_{BS} = 15$  V
- $V_{CC}$  &  $V_{BS}$  Supply Range from 10 V to 20 V
- UVLO Functions for Both Channels
- TTL-Compatible Input Logic Threshold Levels
- Matched Propagation Delay Below 50 ns
- Built-in 100 ns Dead-Time Control Function
- Output In-Phase with Input Signal
- This is a Pb-Free Device

### Typical Applications

- SMPS
- Motor Driver
- PDP Scan Driver
- Industrial Application

### Related Resources

- [AN-6076](#) – Design and Application Guide of Bootstrap Circuit for High-Voltage Gate-Drive IC
- [AN-9052](#) – Design Guide for Selection of Bootstrap Components
- [AN-8102](#) – Recommendations to Avoid Short Pulse Width Issues in HVIC Gate Driver Applications

### MARKING DIAGRAM

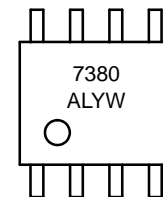

- 7380 = Device Code
- A = Assembly Site
- L = Wafer Lot Number
- YW = Assembly Start Week

### ORDERING INFORMATION

See detailed ordering and shipping information on page 11 of this data sheet.

# FAN7380-OP

## TYPICAL APPLICATION CIRCUIT

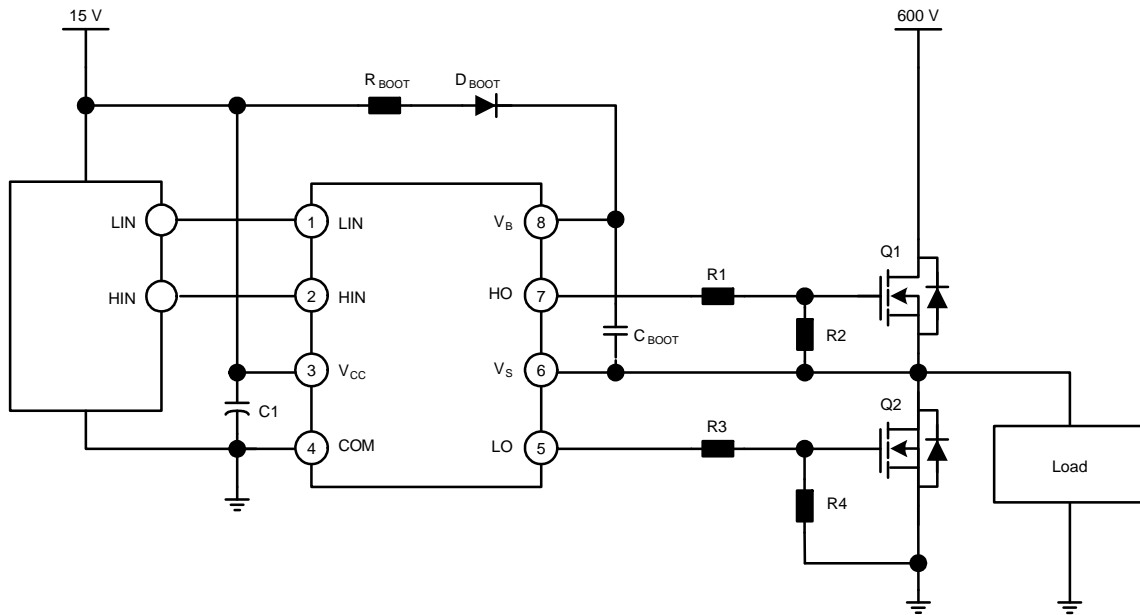

Figure 1. Application Circuit for Half-Bridge

## INTERNAL BLOCK DIAGRAM

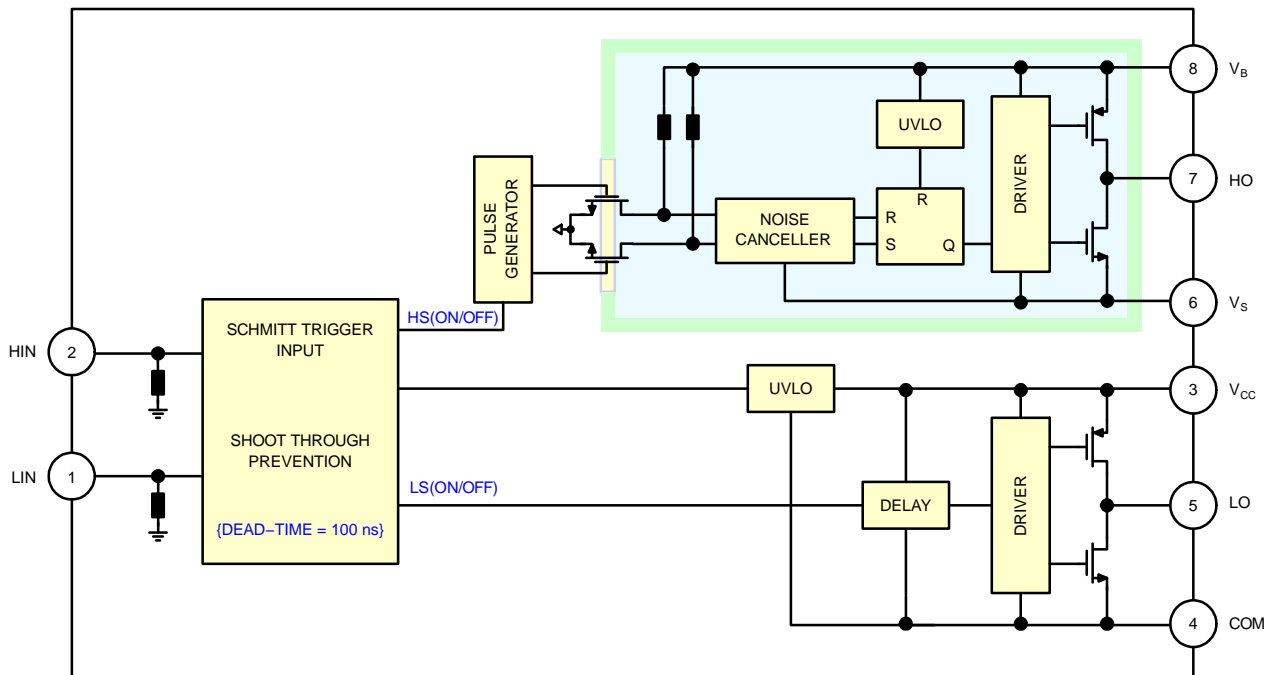

Figure 2. Functional Block Diagram

# FAN7380-OP

## PIN CONFIGURATION

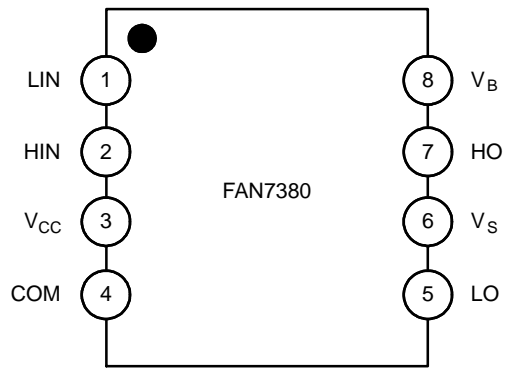

Figure 3. Pin Configuration (Top View)

### PIN DEFINITIONS

| Pin No. | Name            | I/O | Description                                  |
|---------|-----------------|-----|--|
| 1       | LIN             | I   | Logic Input for Low-Side Gate Driver Output  |
| 2       | HIN             | I   | Logic Input for High-Side Gate Driver Output |
| 3       | V <sub>CC</sub> | I   | Low-Side Supply Voltage                      |
| 4       | COM             |     | Logic Ground and Low-Side Driver Return      |
| 5       | LO              | O   | Low-Side Driver Output                       |
| 6       | V <sub>S</sub>  | I   | High-Voltage Floating Supply Return          |
| 7       | HO              | O   | High-Side Driver Output                      |
| 8       | V <sub>B</sub>  | I   | High-Side Floating Supply                    |

# FAN7380-OP

## ABSOLUTE MAXIMUM RATINGS (T<sub>A</sub> = 25°C, unless otherwise specified.)

| Symbol                           | Parameter                               | Min                  | Max                   | Unit |
|----------------------------------|---|----------------------|-----------------------|------|
| V <sub>S</sub>                   | High-side Offset Voltage                | V <sub>B</sub> - 25  | V <sub>B</sub> + 0.3  | V    |
| V <sub>B</sub>                   | High-side Floating Supply Voltage       | -0.3                 | 625.0                 |      |
| V <sub>HO</sub>                  | High-side Floating Output Voltage HO    | V <sub>S</sub> - 0.3 | V <sub>B</sub> + 0.3  |      |
| V <sub>CC</sub>                  | Low-side and Logic-fixed Supply Voltage | -0.3                 | 25.0                  |      |
| V <sub>LO</sub>                  | Low-side Output Voltage LO              | -0.3                 | V <sub>CC</sub> + 0.3 |      |
| V <sub>IN</sub>                  | Logic Input Voltage (HIN, LIN)          | -0.3                 | V <sub>CC</sub> + 0.3 |      |
| COM                              | Logic Ground                            | V <sub>CC</sub> - 25 | V <sub>CC</sub> + 0.3 |      |
| dV <sub>S</sub> /dt              | Allowable Offset Voltage Slew Rate      | -                    | 50                    | V/ns |
| P <sub>D</sub><br>(Note 1, 2, 3) | Power Dissipation                       | -                    | 0.625                 | W    |
| θ <sub>JA</sub>                  | Thermal Resistance, Junction-to-ambient | -                    | 200                   | °C/W |
| T <sub>J</sub>                   | Junction Temperature                    | -                    | 150                   | °C   |
| T <sub>S</sub>                   | Storage Temperature                     | -50                  | 150                   | °C   |

Stresses exceeding those listed in the Maximum Ratings table may damage the device. If any of these limits are exceeded, device functionality should not be assumed, damage may occur and reliability may be affected.

1. Mounted on 76.2 x 114.3 x 1.6 mm PCB (FR-4 glass epoxy material).
2. Refer to the following standards:  
 JESD51-2: Integral circuits thermal test method environmental conditions – natural convection  
 JESD51-3: Low effective thermal conductivity test board for leaded surface mount packages
3. Do not exceed P<sub>D</sub> under any circumstances.

## RECOMMENDED OPERATING RATINGS

| Symbol          | Parameter                                | Min                 | Max                 | Unit |
|-----------------|--|---------------------|---------------------|------|
| V <sub>B</sub>  | High-side Floating Supply Voltage        | V <sub>S</sub> + 10 | V <sub>S</sub> + 20 | V    |
| V <sub>S</sub>  | High-side Floating Supply Offset Voltage | 6 - V <sub>CC</sub> | 600                 |      |
| V <sub>HO</sub> | High-side (HO) Output Voltage            | V <sub>S</sub>      | V <sub>B</sub>      |      |
| V <sub>LO</sub> | Low-side (LO) Output Voltage             | COM                 | V <sub>CC</sub>     |      |
| V <sub>IN</sub> | Logic Input Voltage (HIN, LIN)           | COM                 | V <sub>CC</sub>     |      |
| V <sub>CC</sub> | Low-side Supply Voltage                  | 10                  | 20                  |      |
| T <sub>A</sub>  | Ambient Temperature                      | -40                 | 125                 | °C   |

Functional operation above the stresses listed in the Recommended Operating Ranges is not implied. Extended exposure to stresses beyond the Recommended Operating Ranges limits may affect device reliability.

## FAN7380-OP

**STATIC ELECTRICAL CHARACTERISTICS** ( $V_{BIAS}$  ( $V_{CC}$ ,  $V_{BS}$ ) = 15.0 V,  $T_A$  = 25°C, unless otherwise specified. The  $V_{IN}$  and  $I_{IN}$  parameters are referenced to COM. The  $V_O$  and  $I_O$  parameters are referenced to  $V_S$  and COM and are applicable to the respective outputs HO and LO.)

| Symbol                     | Parameter   | Test Condition   | Min | Typ  | Max  | Unit    |
|----------------------------|---|--|-----|------|------|---------|
| $V_{CCUV+}$<br>$V_{BSUV+}$ | $V_{CC}$ & $V_{BS}$ Supply Under-voltage Positive Going Threshold     |  | 8.2 | 9.2  | 10.0 | V       |
| $V_{CCUV-}$<br>$V_{BSUV-}$ | $V_{CC}$ & $V_{BS}$ Supply Under-voltage Negative Going Threshold     |  | 7.6 | 8.7  | 9.6  |         |
| $V_{CCUVH}$<br>$V_{BSUVH}$ | $V_{CC}$ Supply Under-voltage Lockout Hysteresis                      |  | –   | 0.5  | –    |         |
| $I_{LK}$                   | Offset Supply Leakage Current   | $V_B = V_S = 600$ V                                    | –   | –    | 50   | $\mu$ A |
| $I_{QBS}$                  | Quiescent $V_{BS}$ Supply Current                                     | $V_{IN} = 0$ V or 5 V                                  | –   | 44   | 100  |         |
| $I_{QCC}$                  | Quiescent $V_{CC}$ Supply Current                                     | $V_{IN} = 0$ V or 5 V                                  | –   | 70   | 180  |         |
| $I_{PBS}$                  | Operating $V_{BS}$ Supply Current                                     | $f_{IN} = 20$ kHz, rms value                           | –   | –    | 600  | $\mu$ A |
| $I_{PCC}$                  | Operating $V_{CC}$ Supply Current                                     | $f_{IN} = 20$ kHz, rms value                           | –   | –    | 610  |         |
| $V_{IH}$                   | Logic “1” Input Voltage   |  | 2.5 | –    | –    | V       |
| $V_{IL}$                   | Logic “0” Input Voltage   |  | –   | –    | 0.8  |         |
| $V_{OH}$                   | High-level Output Voltage, $V_{BIAS}-V_O$                             | $I_O = 20$ mA  | –   | –    | 2.8  | V       |
| $V_{OL}$                   | Low-level Output Voltage, $V_O$                                       |  | –   | –    | 1.2  |         |
| $I_{IN+}$                  | Logic “1” Input Bias Current  | $V_{IN} = 5$ V   | –   | 5    | 40   | $\mu$ A |
| $I_{IN-}$                  | Logic “0” Input Bias Current  | $V_{IN} = 0$ V   | –   | 1.0  | 2.0  |         |
| $I_{O+}$                   | Output HIGH Short-circuit Pulse Current                               | $V_O = 0$ V, $V_{IN} = 5$ V with $PW \leq 10$ $\mu$ s  | 60  | 90   | –    | mA      |
| $I_{O-}$                   | Output LOW Short-circuit Pulsed Current                               | $V_O = 15$ V, $V_{IN} = 0$ V with $PW \leq 10$ $\mu$ s | 130 | 180  | –    |         |
| $V_S$                      | Allowable Negative $V_S$ Pin Voltage for HIN Signal Propagation to HO |  | –   | –9.8 | –7.0 | V       |

Product parametric performance is indicated in the Electrical Characteristics for the listed test conditions, unless otherwise noted. Product performance may not be indicated by the Electrical Characteristics if operated under different conditions.

**DYNAMIC ELECTRICAL CHARACTERISTICS** ( $V_{BIAS}$  ( $V_{CC}$ ,  $V_{BS}$ ) = 15.0 V,  $V_S$  = COM,  $C_L$  = 1000 pF and  $T_A$  = 25°C, unless otherwise specified.)

| Symbol    | Parameter                           | Test Condition                | Min | Typ | Max | Unit |
|-----------|-------------------------------------|-------------------------------|-----|-----|-----|------|
| $t_{on}$  | Turn-on Propagation Delay           | $V_S = 0$ V                   | 70  | 135 | 200 | ns   |
| $t_{off}$ | Turn-off Propagation Delay          | $V_S = 0$ V or 600 V (Note 4) | 60  | 130 | 190 |      |
| $t_r$     | Turn-on Rise Time                   |                               | 160 | 230 | 290 |      |
| $t_f$     | Turn-off Fall Time                  |                               | 20  | 90  | 160 |      |
| DT        | Dead Time                           |                               | 80  | 120 | 190 |      |
| MT        | Delay Matching, HS & LS Turn-on/off |                               | –   | –   | 50  |      |

Product parametric performance is indicated in the Electrical Characteristics for the listed test conditions, unless otherwise noted. Product performance may not be indicated by the Electrical Characteristics if operated under different conditions.

4. This parameter guaranteed by design.

TYPICAL PERFORMANCE CHARACTERISTICS

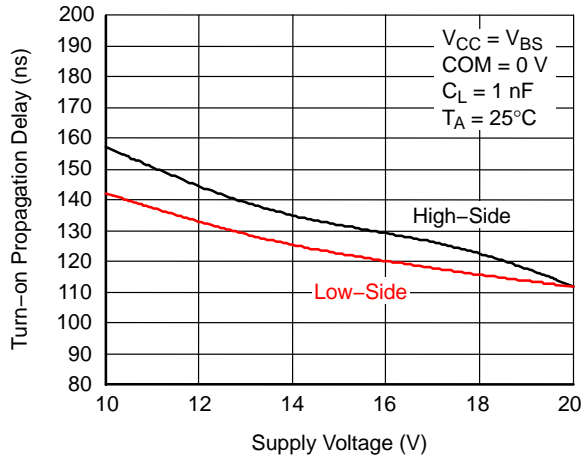

Figure 4. Turn-On Propagation Delay vs. Supply Voltage

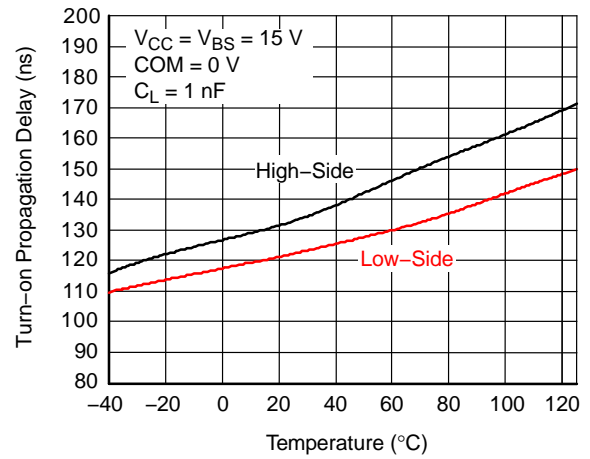

Figure 5. Turn-On Propagation Delay vs. Temperature

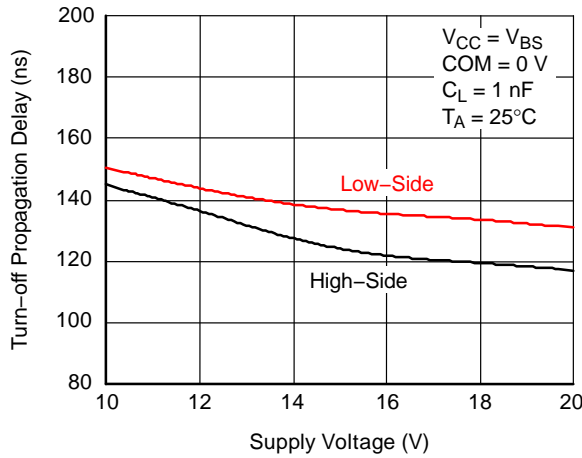

Figure 6. Turn-Off Propagation Delay vs. Supply Voltage

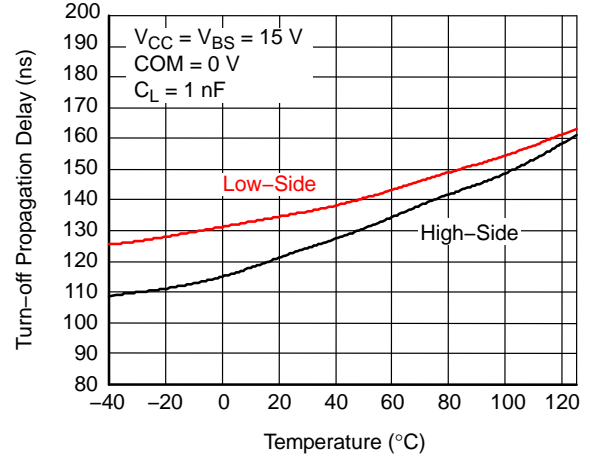

Figure 7. Turn-Off Propagation Delay vs. Temperature

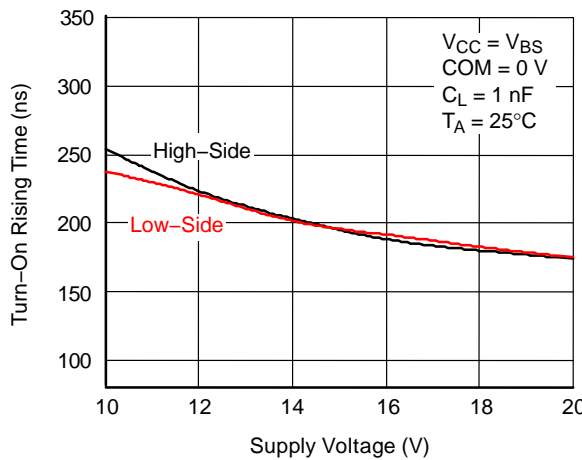

Figure 8. Turn-On Rising Time vs. Supply Voltage

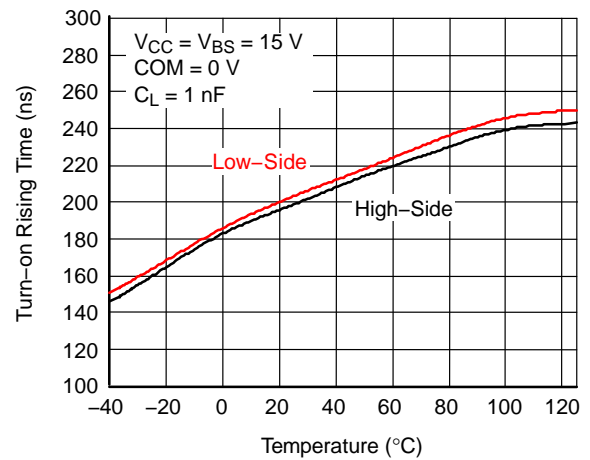

Figure 9. Turn-On Rising Time vs. Temperature

# FAN7380-OP

## TYPICAL PERFORMANCE CHARACTERISTICS (Continued)

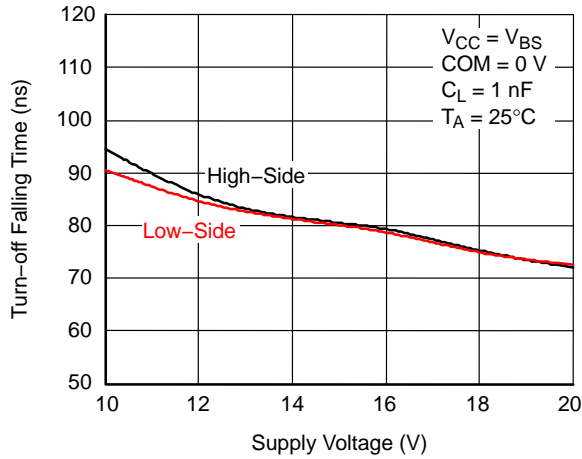

Figure 10. Turn-Off Falling Time vs. Supply Voltage

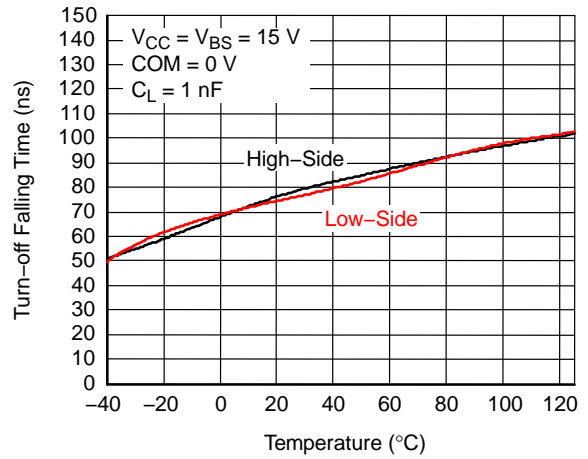

Figure 11. Turn-Off Falling Time vs. Temperature

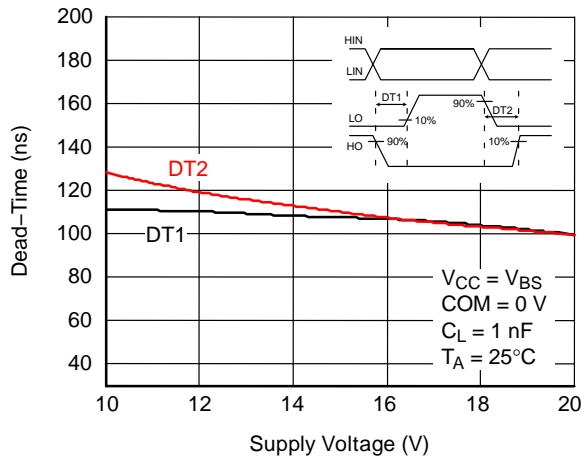

Figure 12. Dead-Time vs. Supply Voltage

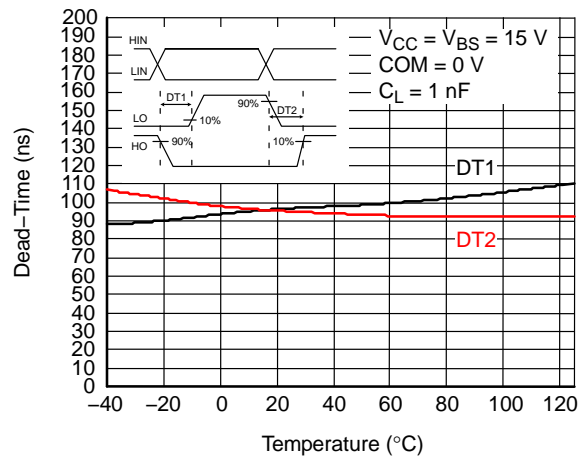

Figure 13. Dead-Time vs. Temperature

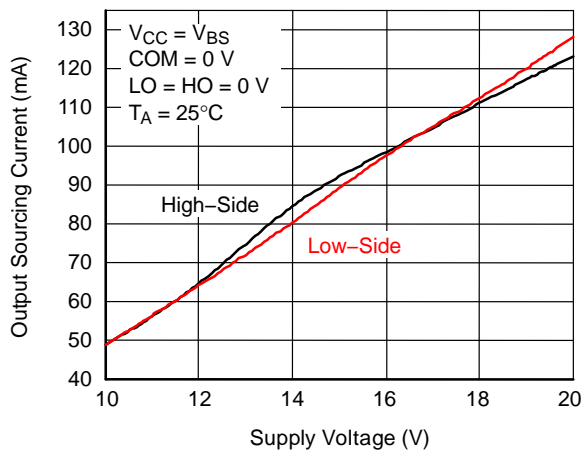

Figure 14. Output Sourcing Current vs. Supply Voltage

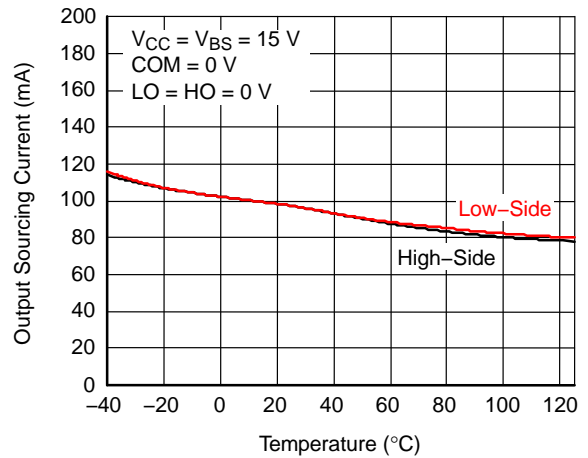

Figure 15. Output Sourcing Current vs. Temperature

TYPICAL PERFORMANCE CHARACTERISTICS (Continued)

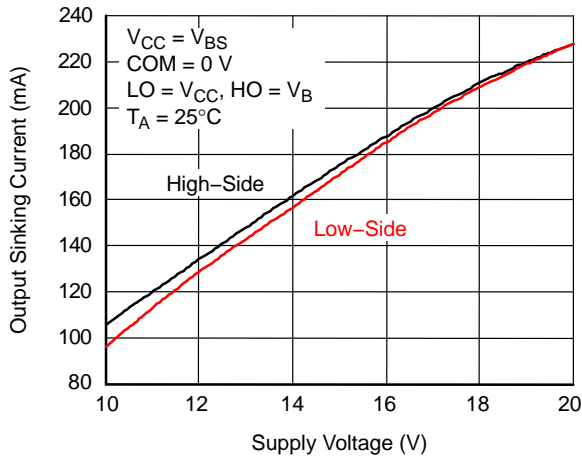

Figure 16. Output Sinking Current vs. Supply Voltage

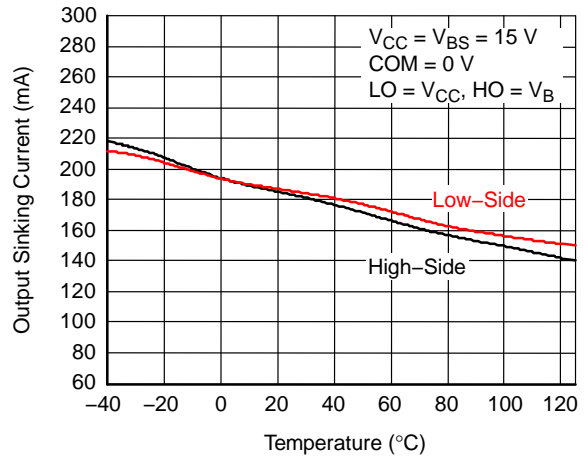

Figure 17. Output Sinking Current vs. Temperature

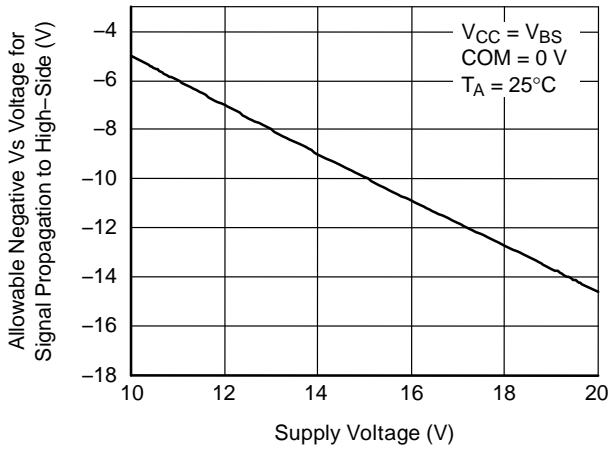

Figure 18. Allowable Negative Vs Voltage for Signal Propagation to High-Side vs. Supply Voltage

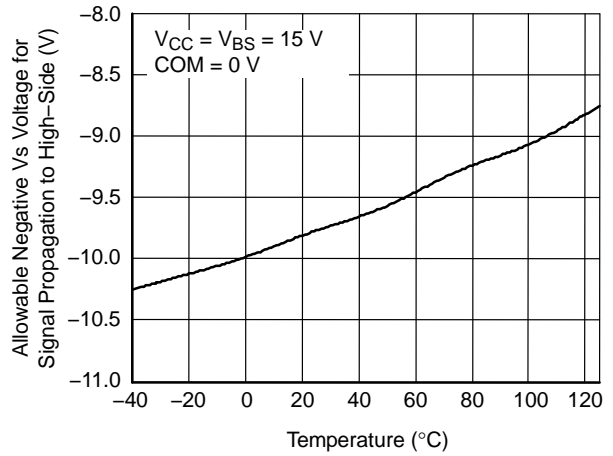

Figure 19. Allowable Negative Vs Voltage for Signal Propagation to High-Side vs. Temperature

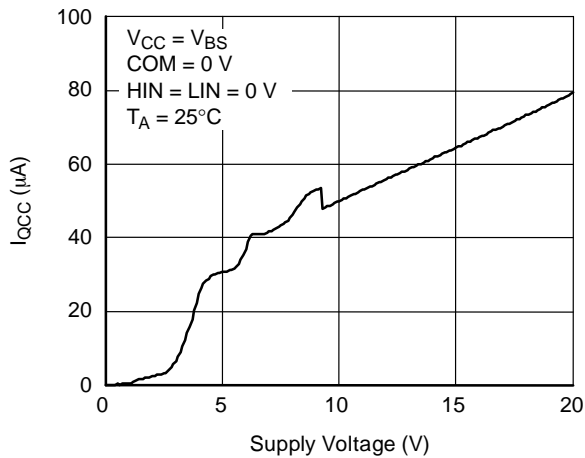

Figure 20.  $I_{QCC}$  vs. Supply Voltage

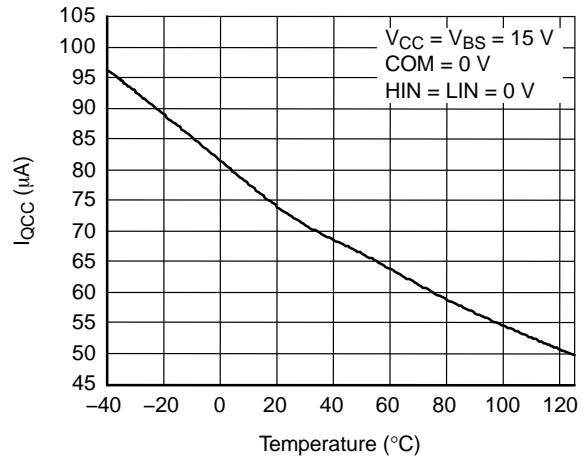

Figure 21.  $I_{QCC}$  vs. Temperature



# FAN7380-OP

## TYPICAL PERFORMANCE CHARACTERISTICS (Continued)

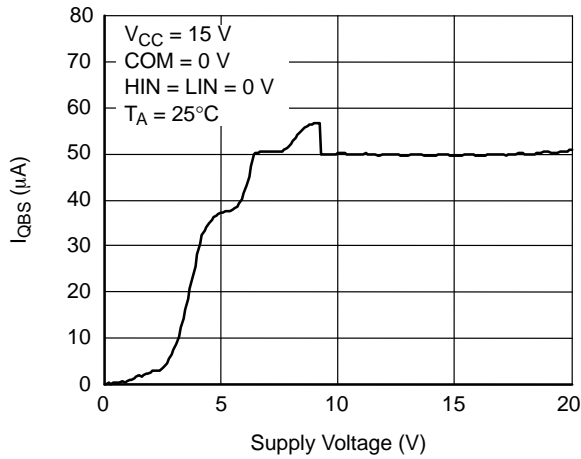

Figure 22.  $I_{QBS}$  vs. Supply Voltage

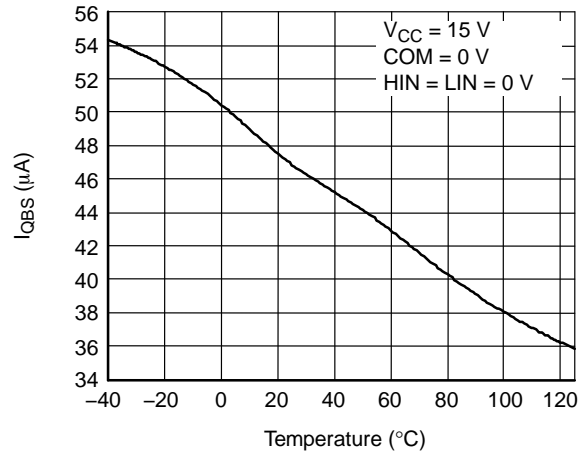

Figure 23.  $I_{QBS}$  vs. Temperature

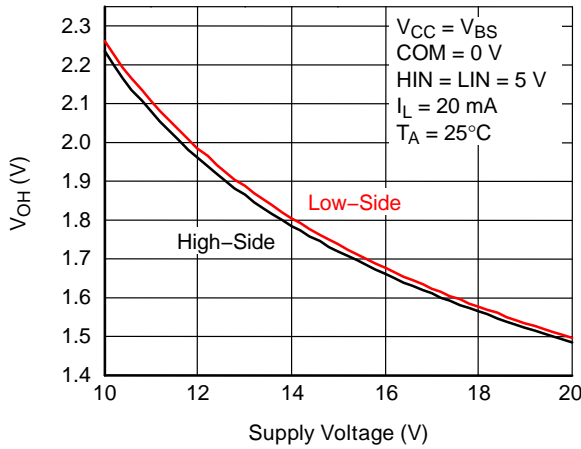

Figure 24. High-Level Output Voltage vs. Supply Voltage

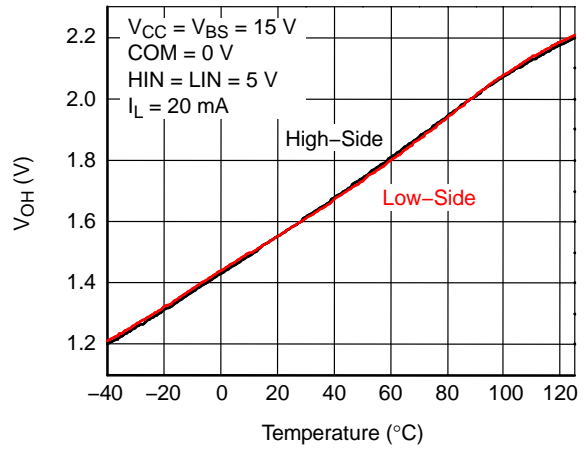

Figure 25. High-Level Output Voltage vs. Temperature

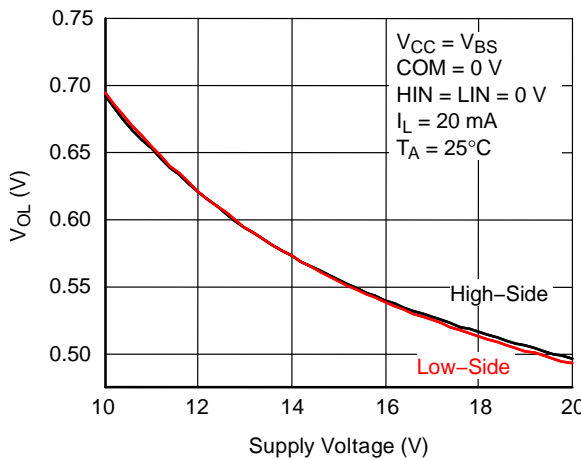

Figure 26. Low-Level Output Voltage vs. Supply Voltage

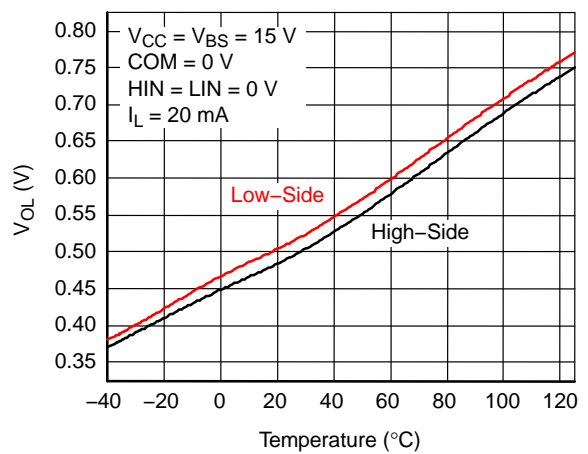

Figure 27. Low-Level Output Voltage vs. Temperature

TYPICAL PERFORMANCE CHARACTERISTICS (Continued)

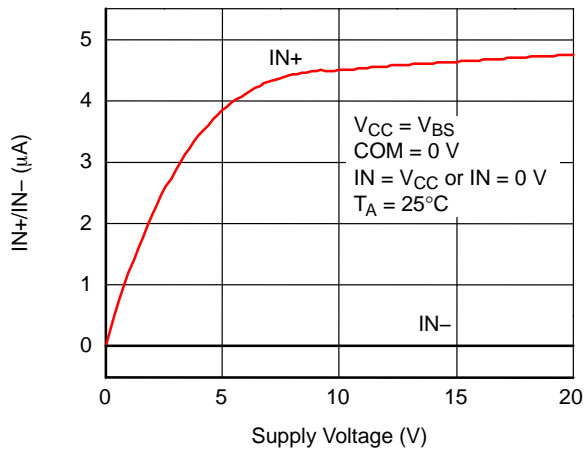

Figure 28. Input Bias Current vs. Supply Voltage

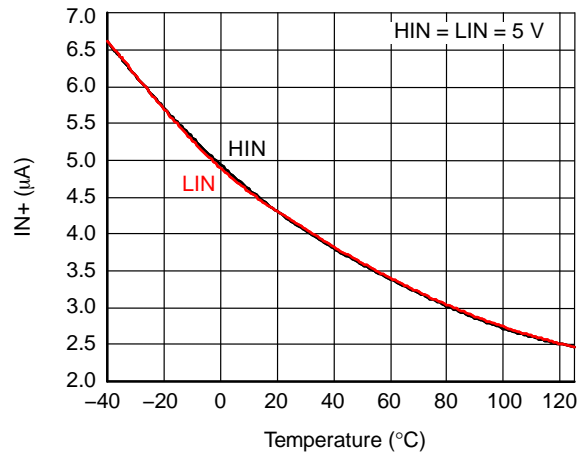

Figure 29. Input Bias Current vs. Temperature

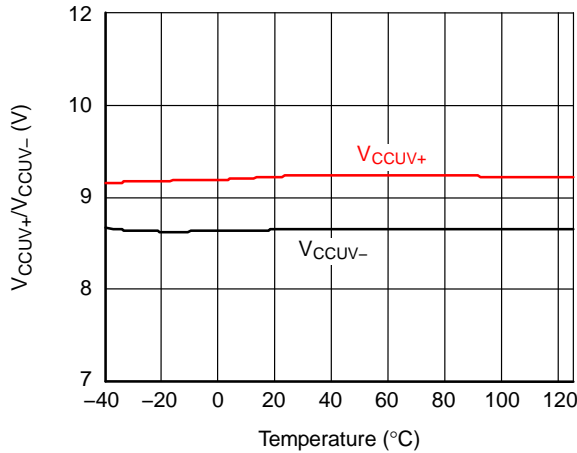

Figure 30.  $V_{CC}$  UVLO Threshold Voltage vs. Temperature

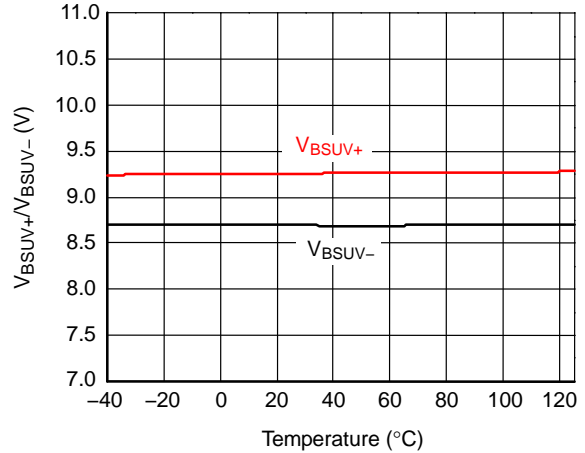

Figure 31.  $V_{BS}$  UVLO Threshold Voltage vs. Temperature

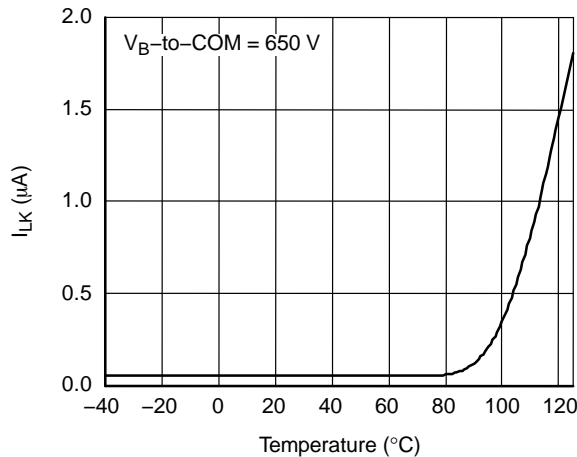

Figure 32.  $V_B$  to COM Leakage Current vs. Temperature

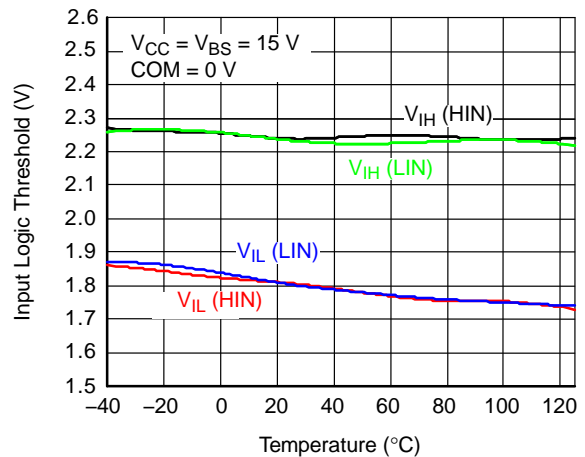

Figure 33. Input Logic Threshold vs. Temperature

# FAN7380-OP

## SWITCHING TIME DEFINITIONS

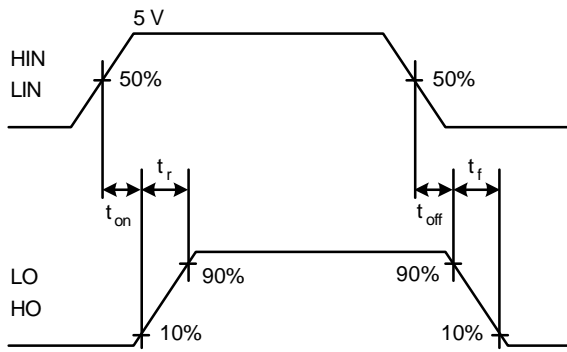

Figure 34. Switching Time Waveforms

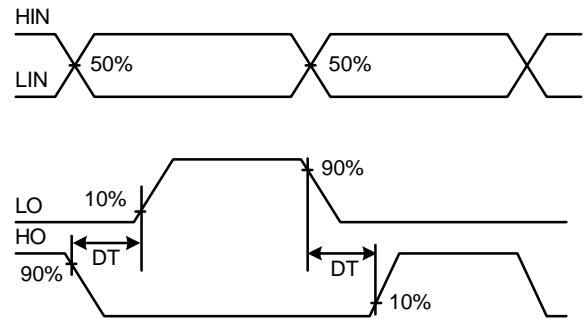

Figure 35. Internal Dead-Time Timing

## ORDERING INFORMATION

| Device                | Package                    | Operating Temperature | Description         | Shipping <sup>†</sup> |
|-----------------------|----------------------------|-----------------------|---------------------|-----------------------|
| FAN7380MX-OP (Note 5) | SOIC8 (8-SOP)<br>(Pb-Free) | -40°C~+125°C          | General Application | 3000 / Tape & Reel    |

5. This device has passed wave soldering test by JESD22A-111.

<sup>†</sup>For information on tape and reel specifications, including part orientation and tape sizes, please refer to our Tape and Reel Packaging Specifications Brochure, BRD8011/D.

**MECHANICAL CASE OUTLINE**  
**PACKAGE DIMENSIONS**

ON Semiconductor®



**SOIC8**  
**CASE 751EG**  
**ISSUE O**

DATE 30 SEP 2016

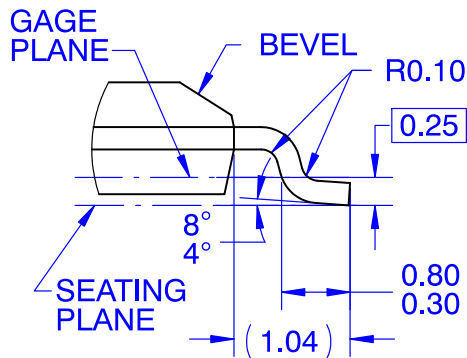
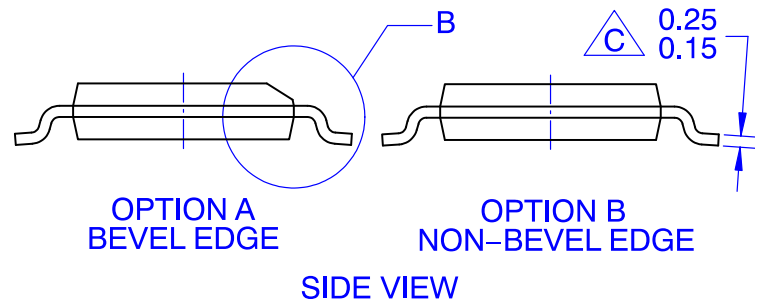
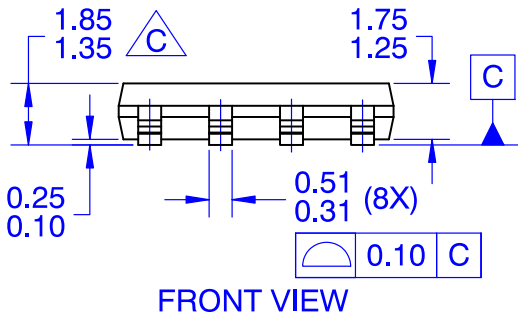
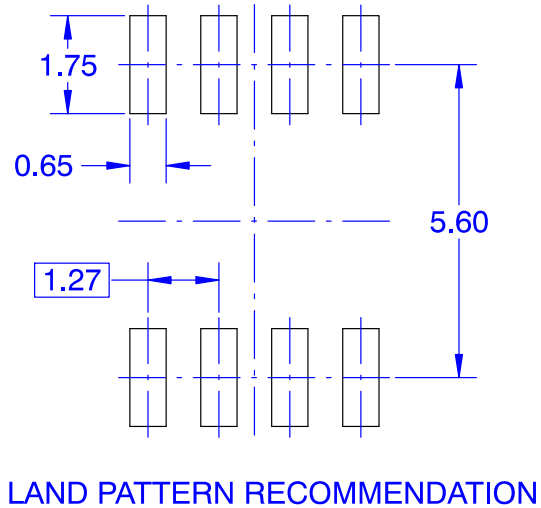
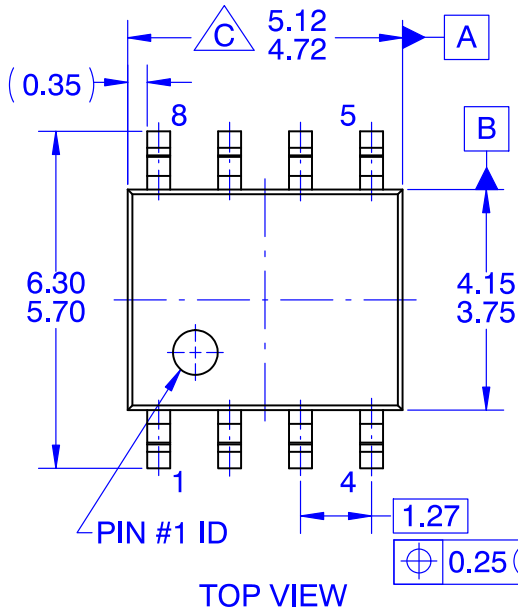

**NOTES: UNLESS OTHERWISE SPECIFIED**

- A. THIS PACKAGE CONFORMS TO JEDEC MS-012 VARIATION A EXCEPT WHERE NOTED.
- B. ALL DIMENSIONS ARE IN MILLIMETERS
- C. OUT OF JEDEC STANDARD VALUE
- D. DIMENSIONS ARE EXCLUSIVE OF BURRS, MOLD FLASH AND TIE BAR EXTRUSIONS.
- E. LAND PATTERN AS PER IPC SOIC127P600X175-8M

|                         |                    |  |
|-------------------------|--------------------|--|
| <b>DOCUMENT NUMBER:</b> | <b>98AON13741G</b> | Electronic versions are uncontrolled except when accessed directly from the Document Repository. Printed versions are uncontrolled except when stamped "CONTROLLED COPY" in red. |
| <b>DESCRIPTION:</b>     | <b>SOIC8</b>       | <b>PAGE 1 OF 1</b>   |

ON Semiconductor and are trademarks of Semiconductor Components Industries, LLC dba ON Semiconductor or its subsidiaries in the United States and/or other countries. ON Semiconductor reserves the right to make changes without further notice to any products herein. ON Semiconductor makes no warranty, representation or guarantee regarding the suitability of its products for any particular purpose, nor does ON Semiconductor assume any liability arising out of the application or use of any product or circuit, and specifically disclaims any and all liability, including without limitation special, consequential or incidental damages. ON Semiconductor does not convey any license under its patent rights nor the rights of others.