

## SEANNA-A

~2.3° spot beam. Assembly with holder.

### SPECIFICATION:

Dimensions	Ø 155.2 mm
Height	82 mm
Fastening	pin, screw
ROHS compliant	yes ⓘ

### MATERIALS:

Component	Type	Material	Colour	Finish
SEANNA-FRES	Single lens	PMMA	clear	
SEANNA-A	Single lens	PMMA	clear	
SEANNA-HLD-B-BOTTOMRING	Holder	PA66GF30	black	
SEANNA-HLD-B-TOPRING	Holder	PA66GF30	black	
SEANNA-HLD-B	Holder	PA66GF30	black	
SEANNA-SCREW	Accessory	Stainless steel	clear	







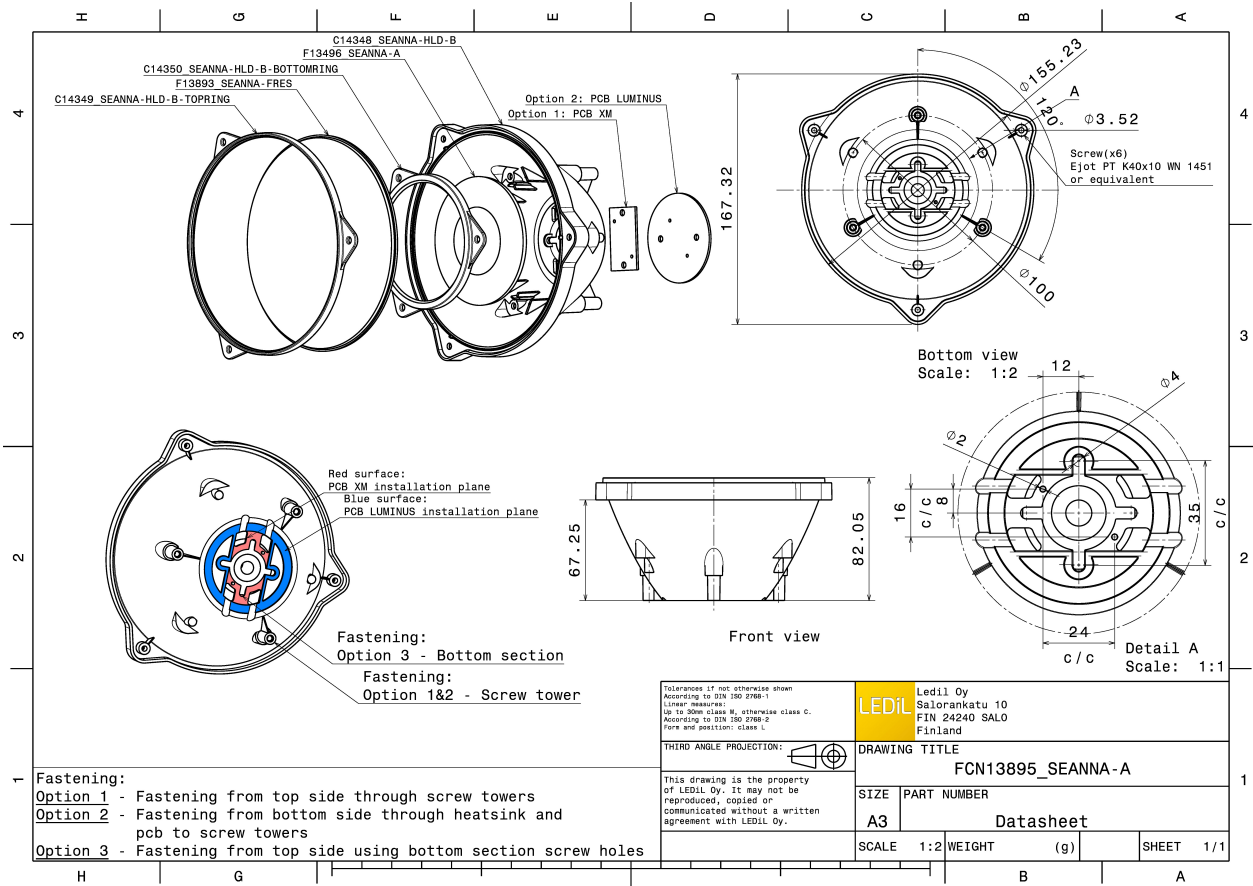

### ORDERING INFORMATION:

Component	Qty in box	MOQ	MPQ	Box weight (kg)
FCP13895_SEANNA-A » Box size:		20	2	6.5

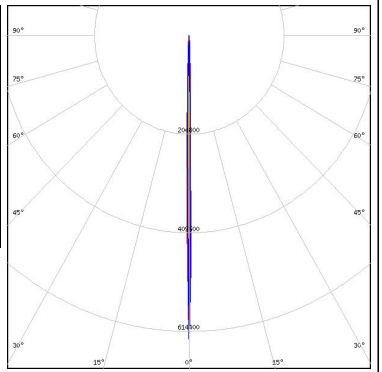

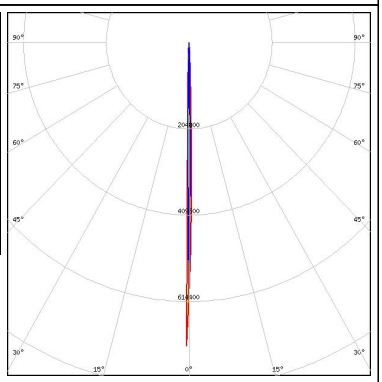
See also our general installation guide: [www.ledil.com/installation\\_guide](http://www.ledil.com/installation_guide)

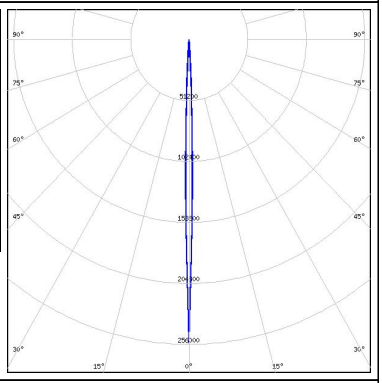
#### OPTICAL RESULTS (MEASURED):

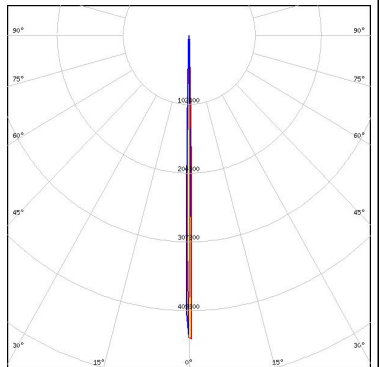
<p><b>CREE</b> ⇄ <b>LED</b></p> <p>LED           XD16            FWHM / FWTM   1.0° / 3.0°            Efficiency       91 %            Peak intensity   629 cd/lm            LEDs/each optic   1            Light colour     White            Required components:</p>		
<p><b>CREE</b> ⇄ <b>LED</b></p> <p>LED           XP-E2            FWHM / FWTM   1.0° / 3.0°            Efficiency       %            Peak intensity   718 cd/lm            LEDs/each optic   1            Light colour     White            Required components:</p>		
<p><b>CREE</b> ⇄ <b>LED</b></p> <p>LED           XP-L HD            FWHM / FWTM   2.4° / 5.3°            Efficiency       94 %            Peak intensity   255 cd/lm            LEDs/each optic   1            Light colour     White            Required components:</p>		
<p><b>CREE</b> ⇄ <b>LED</b></p> <p>LED           XP-L HI            FWHM / FWTM   1.6° / 3.2°            Efficiency       94 %            Peak intensity   492 cd/lm            LEDs/each optic   1            Light colour     White            Required components:</p>		



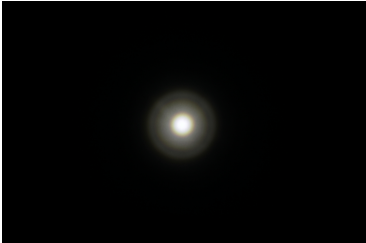
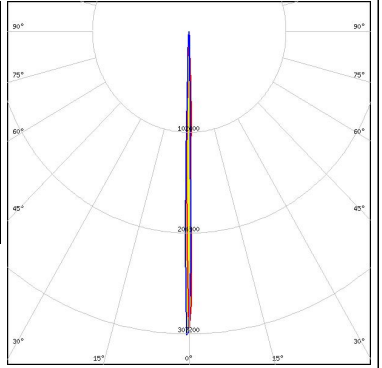
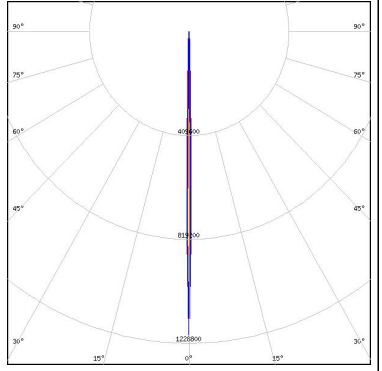
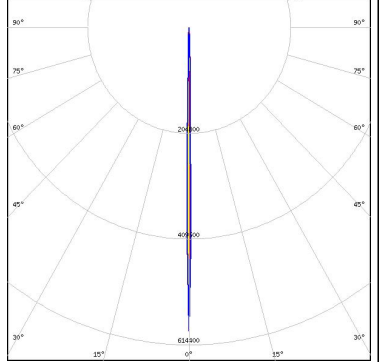



#### OPTICAL RESULTS (MEASURED):

<p><b>NICHIA</b></p> <p>LED NVSW3x9A            FWHM / FWTM 1.9° / 4.1°            Efficiency 92 %            Peak intensity 310 cd/lm            LEDs/each optic 1            Light colour White            Required components:</p>		
<p><b>OSRAM</b>  <small>Opto Semiconductors</small></p> <p>LED OSLON Black Flat (LUW HWQP)            FWHM / FWTM 1.2° / 2.3°            Efficiency 94 %            Peak intensity 1196 cd/lm            LEDs/each optic 1            Light colour White            Required components:</p>		
<p><b>OSRAM</b>  <small>Opto Semiconductors</small></p> <p>LED OSLON Square CSSRM2/CSSRM3            FWHM / FWTM 1.5° / 3.3°            Efficiency 94 %            Peak intensity 587 cd/lm            LEDs/each optic 1            Light colour White            Required components:</p>		

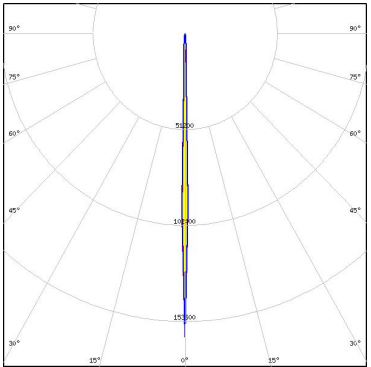
#### OPTICAL RESULTS (SIMULATED):

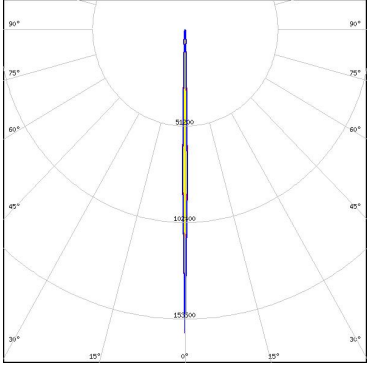
<p><b>CREE</b> → <b>LED</b></p> <p>LED: MK-R            FWHM / FWTM: 4.0° / 10.4°            Efficiency: 91 %            Peak intensity: 82 cd/lm            LEDs/each optic: 1            Light colour: White            Required components:</p>	
<p><b>CREE</b> → <b>LED</b></p> <p>LED: XB-D            FWHM / FWTM: 1.3° / 3.2°            Efficiency: 87 %            Peak intensity: 698 cd/lm            LEDs/each optic: 1            Light colour: White            Required components:</p>	
<p><b>CREE</b> → <b>LED</b></p> <p>LED: XHP35 HD            FWHM / FWTM: 2.4° / 4.2°            Efficiency: 89 %            Peak intensity: 257 cd/lm            LEDs/each optic: 1            Light colour: White            Required components:</p>	
<p><b>CREE</b> → <b>LED</b></p> <p>LED: XHP35 HI            FWHM / FWTM: 1.6° / 3.6°            Efficiency: 83 %            Peak intensity: 496 cd/lm            LEDs/each optic: 1            Light colour: White            Required components:</p>	

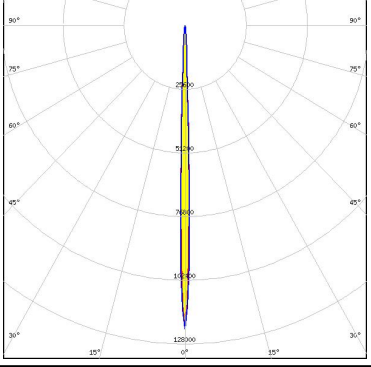

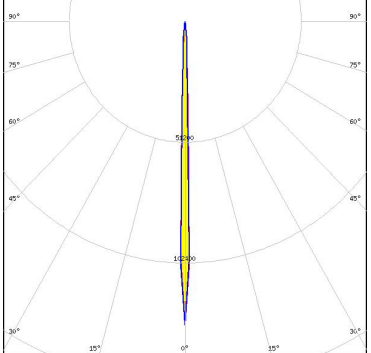



#### OPTICAL RESULTS (SIMULATED):

	<p>LED: XHP35.2 HD            FWHM / FWTM: 2.0° / 6.0°            Efficiency: 89 %            Peak intensity: 161.9 cd/lm            LEDs/each optic: 1            Light colour: White            Required components:</p>	
	<p>LED: XHP35.2 HI            FWHM / FWTM: 2.0° / 4.0°            Efficiency: 89 %            Peak intensity: 161 cd/lm            LEDs/each optic: 1            Light colour: White            Required components:</p>	
	<p>LED: XHP50            FWHM / FWTM: 3.3° / 6.7°            Efficiency: 87 %            Peak intensity: 122 cd/lm            LEDs/each optic: 1            Light colour: White            Required components:</p>	
	<p>LED: XHP50.2            FWHM / FWTM: 2.7° / 6.8°            Efficiency: 84 %            Peak intensity: 128.7 cd/lm            LEDs/each optic: 1            Light colour: White            Required components:</p>	

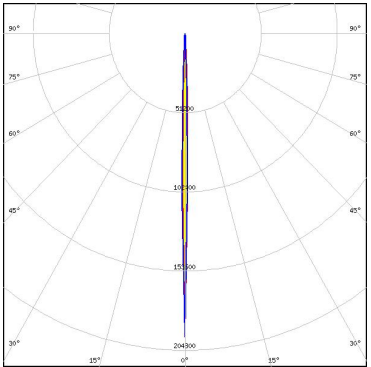
#### OPTICAL RESULTS (SIMULATED):

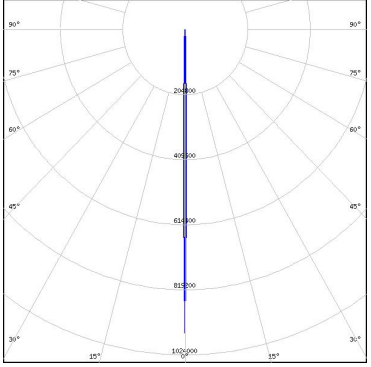

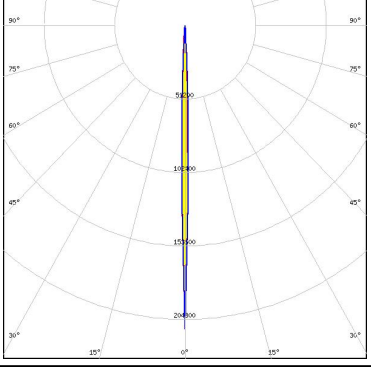

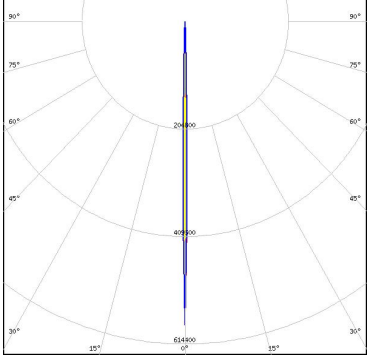

<p><b>CREE</b> → <b>LED</b></p> <p>LED: XHP70            FWHM / FWTM: 4.3° / 10.4°            Efficiency: 81 %            Peak intensity: 69.9 cd/lm            LEDs/each optic: 1            Light colour: White            Required components:</p>	
<p><b>CREE</b> → <b>LED</b></p> <p>LED: XHP70.2            FWHM / FWTM: 4.5° / 10.1°            Efficiency: 83 %            Peak intensity: 71.6 cd/lm            LEDs/each optic: 1            Light colour: White            Required components:</p>	
<p><b>CREE</b> → <b>LED</b></p> <p>LED: XM-L            FWHM / FWTM: 2.4°            Efficiency: %            Peak intensity: 272 cd/lm            LEDs/each optic: 1            Light colour: White            Required components:</p>	
<p><b>CREE</b> → <b>LED</b></p> <p>LED: XM-L2            FWHM / FWTM: 2.0° / 3.9°            Efficiency: 85 %            Peak intensity: 275 cd/lm            LEDs/each optic: 1            Light colour: White            Required components:</p>	

#### OPTICAL RESULTS (SIMULATED):

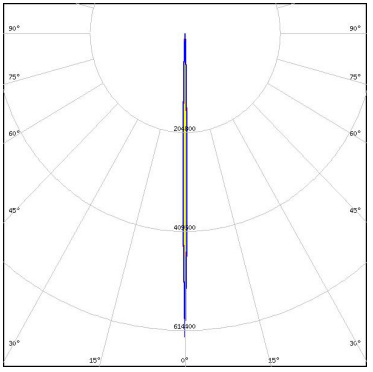
	<p>LED XM-L3            FWHM / FWTM 2.0° / 6.0°            Efficiency 90 %            Peak intensity 196.2 cd/lm            LEDs/each optic 1            Light colour White            Required components:</p>	
	<p>LED XP-E            FWHM / FWTM 1.2° / 2.9°            Efficiency 92 %            Peak intensity 955 cd/lm            LEDs/each optic 1            Light colour White            Required components:</p>	
	<p>LED XP-E2            FWHM / FWTM 2.0° / 6.0°            Efficiency 85 %            Peak intensity 211.5 cd/lm            LEDs/each optic 1            Light colour Blue            Required components:</p>	
	<p>LED XP-G            FWHM / FWTM 1.4° / 3.4°            Efficiency 90 %            Peak intensity 578 cd/lm            LEDs/each optic 1            Light colour White            Required components:</p>	

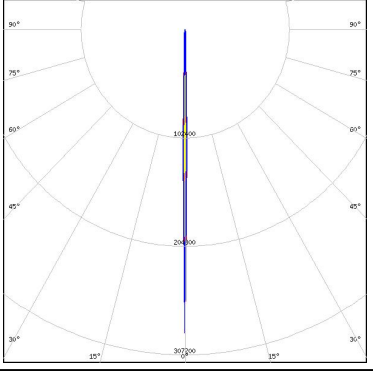

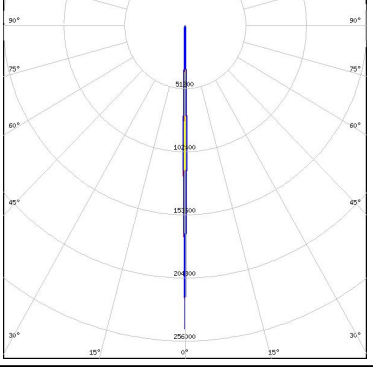
#### OPTICAL RESULTS (SIMULATED):

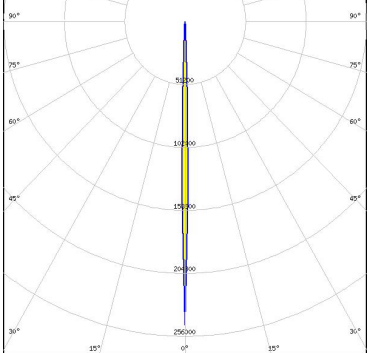
<p><b>CREE</b>  <b>LED</b></p> <p>LED: XP-G2            FWHM / FWTM: 1.4° / 3.2°            Efficiency: 91 %            Peak intensity: 628 cd/lm            LEDs/each optic: 1            Light colour: White            Required components:</p>	
<p><b>CREE</b>  <b>LED</b></p> <p>LED: XP-G2 HE            FWHM / FWTM: 2.0° / 4.0°            Efficiency: 89 %            Peak intensity: 286.5 cd/lm            LEDs/each optic: 1            Light colour: White            Required components:</p>	
<p><b>CREE</b>  <b>LED</b></p> <p>LED: XP-G3            FWHM / FWTM: 2.0° / 4.0°            Efficiency: 88 %            Peak intensity: 246.2 cd/lm            LEDs/each optic: 1            Light colour: White            Required components:</p>	
<p><b>CREE</b>  <b>LED</b></p> <p>LED: XP-P            FWHM / FWTM: 2.0° / 6.0°            Efficiency: 84 %            Peak intensity: 246.8 cd/lm            LEDs/each optic: 1            Light colour: White            Required components:</p>	

#### OPTICAL RESULTS (SIMULATED):



LED XQ-E HD  
 FWHM / FWTM 1.1° / 2.5°  
 Efficiency 92 %  
 Peak intensity 1460 cd/lm  
 LEDs/each optic 1  
 Light colour White  
 Required components:

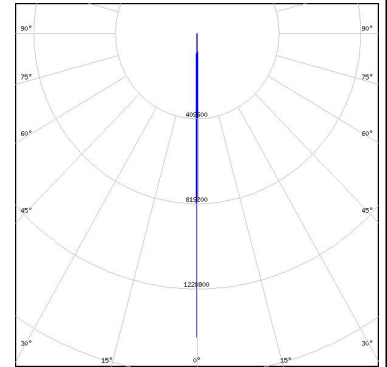

LED XQ-E HI  
 FWHM / FWTM 1.2° / 2.0°  
 Efficiency 90 %  
 Peak intensity 1300 cd/lm  
 LEDs/each optic 1  
 Light colour White  
 Required components:



LED XT-E  
 FWHM / FWTM 1.4° / 3.5°  
 Efficiency 88 %  
 Peak intensity 519 cd/lm  
 LEDs/each optic 1  
 Light colour White  
 Required components:

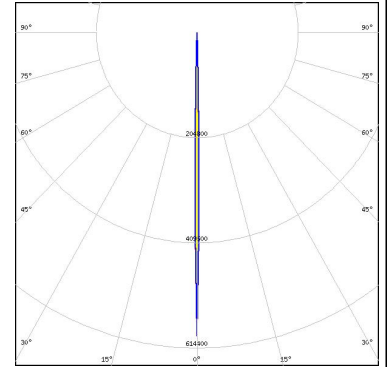

LED LZ4 (00xW00)  
 FWHM / FWTM 3.3° / 8.2°  
 Efficiency 91 %  
 Peak intensity 136 cd/lm  
 LEDs/each optic 1  
 Light colour White  
 Required components:

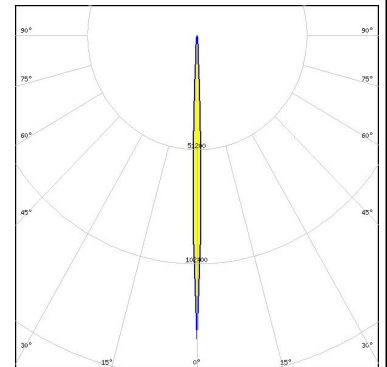

#### OPTICAL RESULTS (SIMULATED):

##### LUMILEDS

LED LUXEON CZ  
 FWHM / FWTM 1.7° / 3.9°  
 Efficiency 93 %  
 Peak intensity 346 cd/lm  
 LEDs/each optic 1  
 Light colour White  
 Required components:

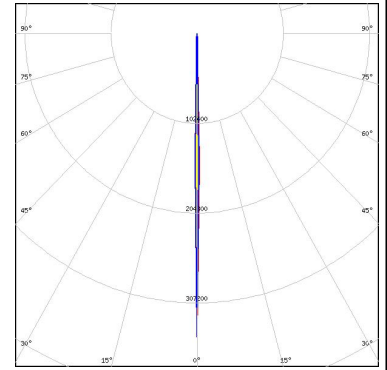

##### LUMILEDS

LED LUXEON CZ  
 FWHM / FWTM 1.4° / 3.7°  
 Efficiency 94 %  
 Peak intensity 424 cd/lm  
 LEDs/each optic 1  
 Light colour Green  
 Required components:

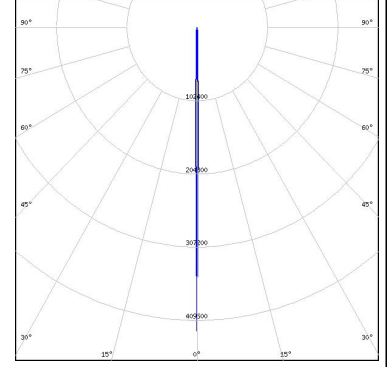

##### LUMILEDS

LED LUXEON CZ  
 FWHM / FWTM 1.2° / 3.3°  
 Efficiency 94 %  
 Peak intensity 564 cd/lm  
 LEDs/each optic 1  
 Light colour Red  
 Required components:

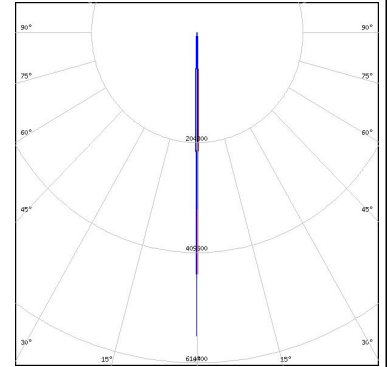

##### LUMILEDS

LED LUXEON CZ  
 FWHM / FWTM 1.6° / 3.8°  
 Efficiency 93 %  
 Peak intensity 371 cd/lm  
 LEDs/each optic 1  
 Light colour Blue  
 Required components:

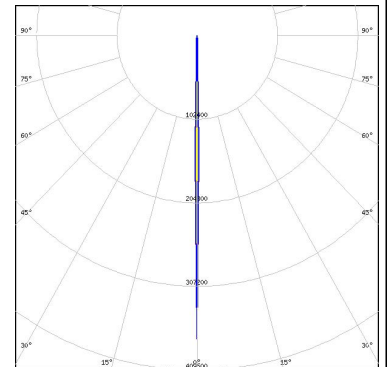

#### OPTICAL RESULTS (SIMULATED):

<p><b>LUMILEDS</b></p> <p>LED: LUXEON CZ</p> <p>FWHM / FWTM: 1.3° / 3.4°</p> <p>Efficiency: 94 %</p> <p>Peak intensity: 564 cd/lm</p> <p>LEDs/each optic: 1</p> <p>Light colour: PC Amber</p> <p>Required components:</p>	
<p><b>LUMILEDS</b></p> <p>LED: LUXEON HL2X</p> <p>FWHM / FWTM: 2.0° / 4.0°</p> <p>Efficiency: 89 %</p> <p>Peak intensity: 317.8 cd/lm</p> <p>LEDs/each optic: 1</p> <p>Light colour: White</p> <p>Required components:</p>	
<p><b>LUMILEDS</b></p> <p>LED: LUXEON M/MX</p> <p>FWHM / FWTM: 3.6° / 9.0°</p> <p>Efficiency: 89 %</p> <p>Peak intensity: 99 cd/lm</p> <p>LEDs/each optic: 1</p> <p>Light colour: White</p> <p>Required components:</p>	
<p><b>LUMILEDS</b></p> <p>LED: LUXEON MZ</p> <p>FWHM / FWTM: 2.2° / 6.0°</p> <p>Efficiency: 84 %</p> <p>Peak intensity: 151 cd/lm</p> <p>LEDs/each optic: 1</p> <p>Light colour: White</p> <p>Required components:</p>	

#### OPTICAL RESULTS (SIMULATED):

<p><b>LUMILEDS</b></p> <p>LED: LUXEON Rebel</p> <p>FWHM / FWTM: 1.3° / 3.2°</p> <p>Efficiency: 90 %</p> <p>Peak intensity: 704 cd/lm</p> <p>LEDs/each optic: 1</p> <p>Light colour: White</p> <p>Required components:</p>	
<p><b>LUMILEDS</b></p> <p>LED: LUXEON Rebel ES</p> <p>FWHM / FWTM: 1.6° / 3.6°</p> <p>Efficiency: 90 %</p> <p>Peak intensity: 530 cd/lm</p> <p>LEDs/each optic: 1</p> <p>Light colour: White</p> <p>Required components:</p>	
<p><b>LUMILEDS</b></p> <p>LED: LUXEON Rubix</p> <p>FWHM / FWTM: 2.0° / 4.0°</p> <p>Efficiency: 88 %</p> <p>Peak intensity: 290.2 cd/lm</p> <p>LEDs/each optic: 1</p> <p>Light colour: White</p> <p>Required components:</p>	
<p><b>LUMILEDS</b></p> <p>LED: LUXEON Rubix</p> <p>FWHM / FWTM: 2.0° / 6.0°</p> <p>Efficiency: 85 %</p> <p>Peak intensity: 196.2 cd/lm</p> <p>LEDs/each optic: 1</p> <p>Light colour: Red</p> <p>Required components:</p>	

#### OPTICAL RESULTS (SIMULATED):

<p><b>LUMILEDS</b></p> <p>LED: LUXEON Rubix</p> <p>FWHM / FWTM: 2.0° / 6.0°</p> <p>Efficiency: 83 %</p> <p>Peak intensity: 157.7 cd/lm</p> <p>LEDs/each optic: 1</p> <p>Light colour: Green</p> <p>Required components:</p>	
<p><b>LUMILEDS</b></p> <p>LED: LUXEON Rubix</p> <p>FWHM / FWTM: 2.0° / 6.0°</p> <p>Efficiency: 83 %</p> <p>Peak intensity: 141.9 cd/lm</p> <p>LEDs/each optic: 1</p> <p>Light colour: Blue</p> <p>Required components:</p>	
<p><b>LUMILEDS</b></p> <p>LED: LUXEON S1000</p> <p>FWHM / FWTM: 3.8° / 8.0°</p> <p>Efficiency: 88 %</p> <p>Peak intensity: 100 cd/lm</p> <p>LEDs/each optic: 1</p> <p>Light colour: White</p> <p>Required components:</p>	
<p><b>LUMILEDS</b></p> <p>LED: LUXEON V2</p> <p>FWHM / FWTM: 2.0° / 4.0°</p> <p>Efficiency: 88 %</p> <p>Peak intensity: 250.1 cd/lm</p> <p>LEDs/each optic: 1</p> <p>Light colour: White</p> <p>Required components:</p>	

#### OPTICAL RESULTS (SIMULATED):

<p><b>LUMINUS</b></p> <p>LED: SBT-90            FWHM / FWTM: 2.0° / 6.0°            Efficiency: 76 %            Peak intensity: 175.9 cd/lm            LEDs/each optic: 1            Light colour: White            Required components:</p>	
<p><b>LUMINUS</b></p> <p>LED: SBT-90            FWHM / FWTM: 2.3° / 4.8°            Efficiency: 90 %            Peak intensity: 253 cd/lm            LEDs/each optic: 1            Light colour: White            Required components:</p>	
<p><b>NICHIA</b></p> <p>LED: NV4WB35AM            FWHM / FWTM: 2.0° / 4.0°            Efficiency: 90 %            Peak intensity: 185.5 cd/lm            LEDs/each optic: 1            Light colour: White            Required components:</p>	
<p><b>NICHIA</b></p> <p>LED: NVSW219F            FWHM / FWTM: 2.0° / 4.0°            Efficiency: 89 %            Peak intensity: 296 cd/lm            LEDs/each optic: 1            Light colour: White            Required components:</p>	

#### OPTICAL RESULTS (SIMULATED):

<p><b>NICHIA</b></p> <p>LED: NVSW519A            FWHM / FWTM: 2.0° / 4.0°            Efficiency: 89 %            Peak intensity: 251.6 cd/lm            LEDs/each optic: 1            Light colour: White            Required components:</p>	
<p><b>NICHIA</b></p> <p>LED: NVSW719AC            FWHM / FWTM: 2.0° / 6.0°            Efficiency: 85 %            Peak intensity: 207.3 cd/lm            LEDs/each optic: 1            Light colour: White            Required components:</p>	
<p><b>OSRAM</b>  <small>Opto Semiconductors</small></p> <p>LED: OSCONIQ C 2424            FWHM / FWTM: 2.0° / 4.0°            Efficiency: 90 %            Peak intensity: 241.6 cd/lm            LEDs/each optic: 1            Light colour: White            Required components:</p>	
<p><b>OSRAM</b>  <small>Opto Semiconductors</small></p> <p>LED: OSCONIQ P 3737 (2W version)            FWHM / FWTM: 2.0° / 4.0°            Efficiency: 89 %            Peak intensity: 258.2 cd/lm            LEDs/each optic: 1            Light colour: White            Required components:</p>	



#### OPTICAL RESULTS (SIMULATED):

<p><b>OSRAM</b> Opto Semiconductors</p> <p>LED: OSCONIQ P 3737 (3W version)</p> <p>FWHM / FWTM: 2.0° / 4.0°</p> <p>Efficiency: 90 %</p> <p>Peak intensity: 232.3 cd/lm</p> <p>LEDs/each optic: 1</p> <p>Light colour: White</p> <p>Required components:</p>	
<p><b>OSRAM</b> Opto Semiconductors</p> <p>LED: OSCONIQ P 7070</p> <p>FWHM / FWTM: 3.5° / 7.1°</p> <p>Efficiency: 91 %</p> <p>Peak intensity: 122.2 cd/lm</p> <p>LEDs/each optic: 1</p> <p>Light colour: White</p> <p>Required components:</p>	
<p><b>OSRAM</b> Opto Semiconductors</p> <p>LED: OSOLON Boost HX (KW CULPM1.TG)</p> <p>FWHM / FWTM: 2.0° / 6.0°</p> <p>Efficiency: 92 %</p> <p>Peak intensity: 176.8 cd/lm</p> <p>LEDs/each optic: 1</p> <p>Light colour: White</p> <p>Required components:</p>	
<p><b>OSRAM</b> Opto Semiconductors</p> <p>LED: OSOLON Square PC</p> <p>FWHM / FWTM: 1.5° / 3.6°</p> <p>Efficiency: 89 %</p> <p>Peak intensity: 550 cd/lm</p> <p>LEDs/each optic: 1</p> <p>Light colour: White</p> <p>Required components:</p>	

#### OPTICAL RESULTS (SIMULATED):

#### OSRAM

Opto Semiconductors

LED OSRAM OSTAR Projection Compact (KW CSLPM1.TG)  
 FWHM / FWTM 2.0° / 4.0°  
 Efficiency 90 %  
 Peak intensity 229.3 cd/lm  
 LEDs/each optic 1  
 Light colour White  
 Required components:

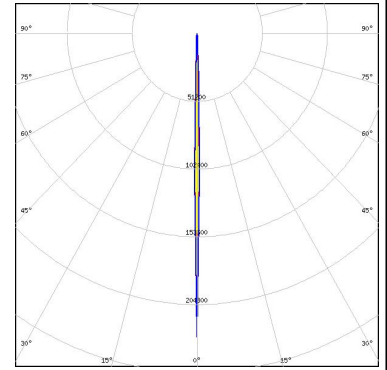

#### SAMSUNG

LED LH351B  
 FWHM / FWTM 2.0° / 4.0°  
 Efficiency 90 %  
 Peak intensity 279.4 cd/lm  
 LEDs/each optic 1  
 Light colour White  
 Required components:

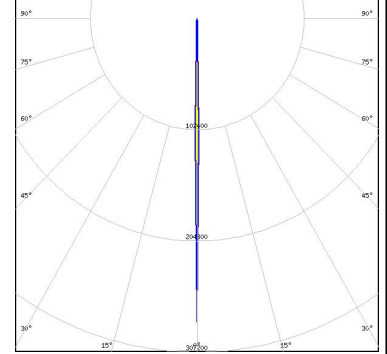

#### SAMSUNG

LED LH351C  
 FWHM / FWTM 2.0° / 4.0°  
 Efficiency 91 %  
 Peak intensity 279.2 cd/lm  
 LEDs/each optic 1  
 Light colour White  
 Required components:

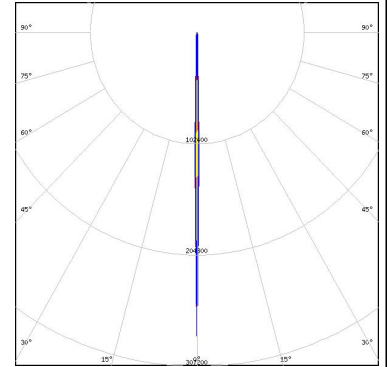



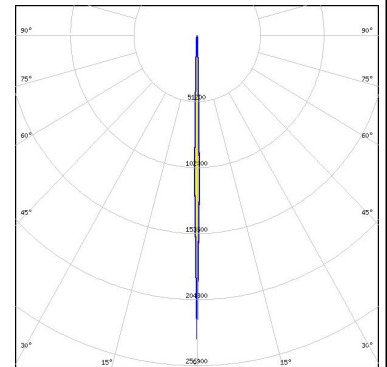

#### SAMSUNG

LED LH351D  
 FWHM / FWTM 2.0° / 4.0°  
 Efficiency 91 %  
 Peak intensity 235.3 cd/lm  
 LEDs/each optic 1  
 Light colour White  
 Required components:

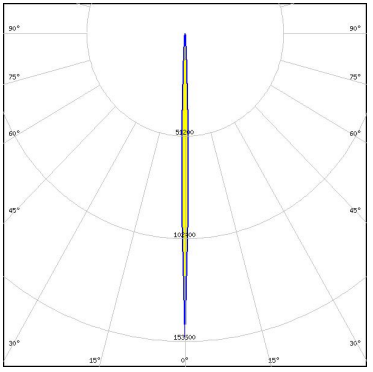

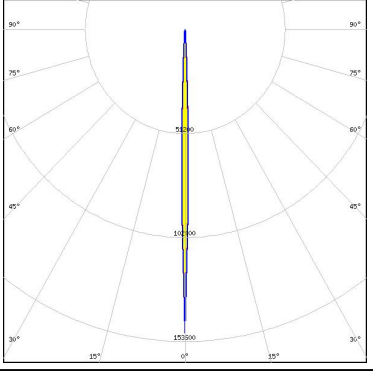
#### OPTICAL RESULTS (SIMULATED):

<p> SEUL SEMICONDUCTOR</p> <p>LED: Z5M3</p> <p>FWHM / FWTM: 1.4° / 3.3°</p> <p>Efficiency: 94 %</p> <p>Peak intensity: 151.4 cd/lm</p> <p>LEDs/each optic: 1</p> <p>Light colour: White</p> <p>Required components:</p>	
<p> SEUL SEMICONDUCTOR</p> <p>LED: Z5M4</p> <p>FWHM / FWTM: 1.7° / 3.5°</p> <p>Efficiency: 96 %</p> <p>Peak intensity: 149.4 cd/lm</p> <p>LEDs/each optic: 1</p> <p>Light colour: White</p> <p>Required components:</p>	
<p> SEUL SEMICONDUCTOR</p> <p>LED: Z8Y50P</p> <p>FWHM / FWTM: 3.0° / 7.0°</p> <p>Efficiency: 79 %</p> <p>Peak intensity: 90.4 cd/lm</p> <p>LEDs/each optic: 1</p> <p>Light colour: White</p> <p>Required components:</p>	