

FLORENTINA-4X1-W

~40° wide beam

SPECIFICATION:

Dimensions	169.7 x 49.7 mm
Height	29.7 mm
Fastening	pin
ROHS compliant	yes ⓘ

MATERIALS:

Component	Type	Material	Colour	Finish
ROSE-C-C-W-V4	Single lens	PC	clear	
FLORENTINA-4X1-HLD	Holder	PC	black	

ORDERING INFORMATION:





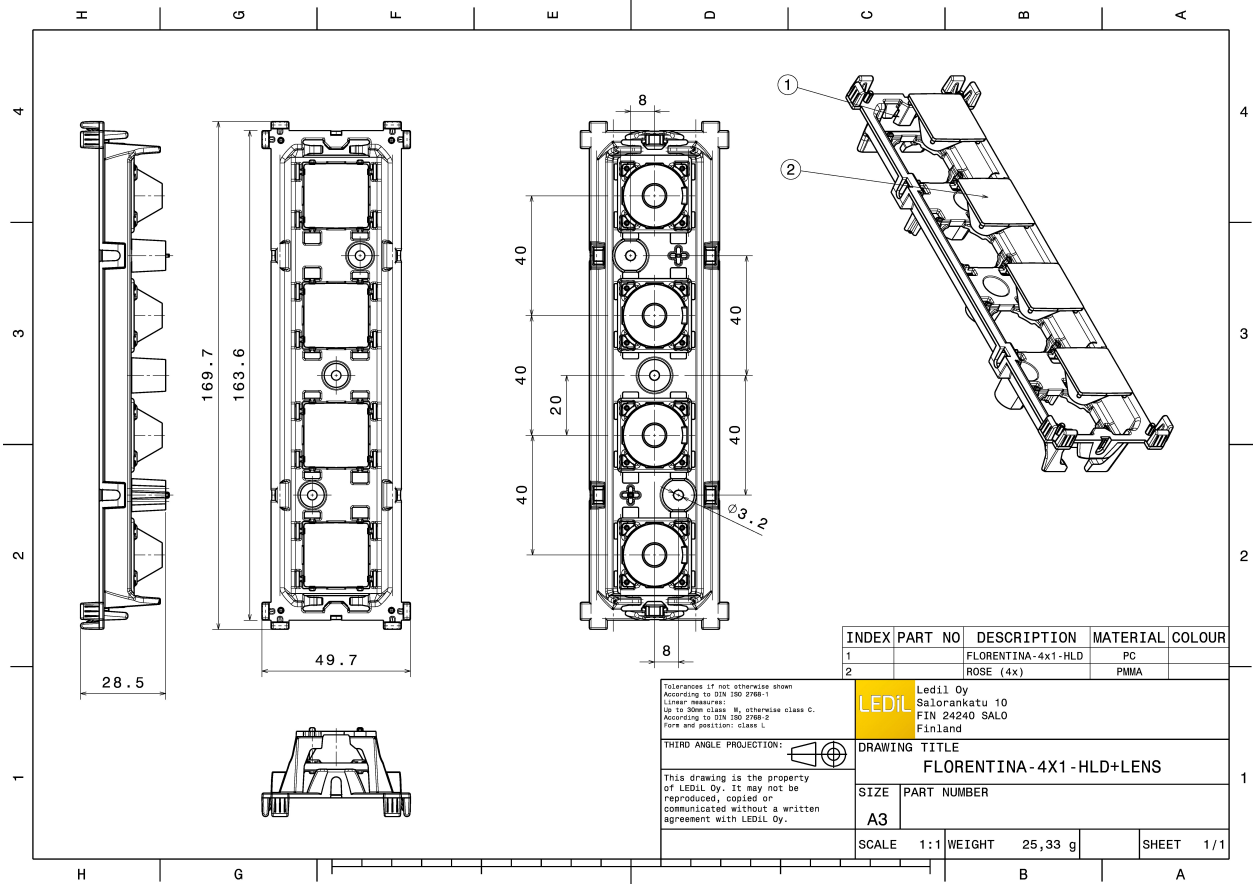

Component	Type	Qty in box	MOQ	MPQ	Box weight (kg)
FCP15348_FLORENTINA-4X1-W » Box size: 476 x 273 x 292 mm	Single lens	72	72	8	3.2



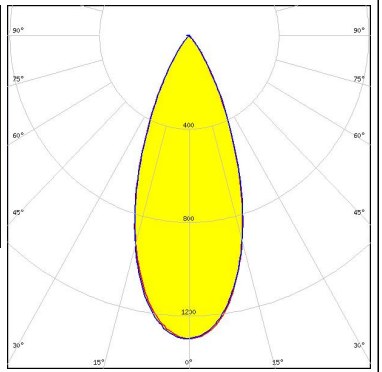

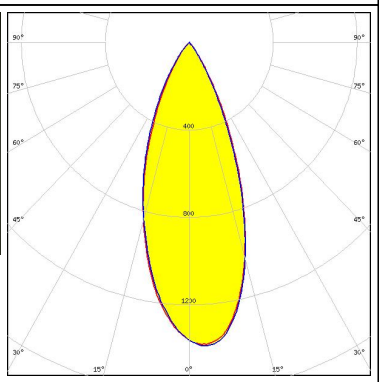

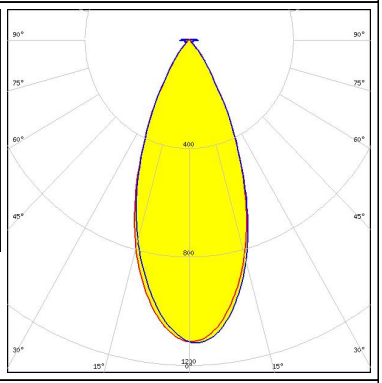

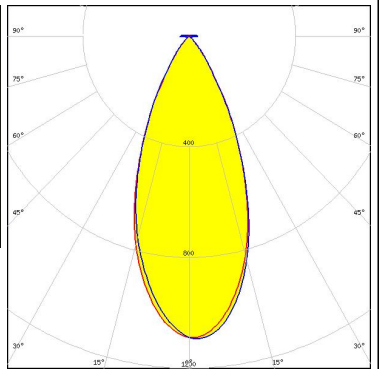

See also our general installation guide: www.ledil.com/installation_guide

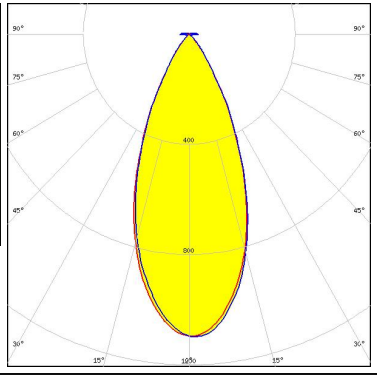
OPTICAL RESULTS (MEASURED):

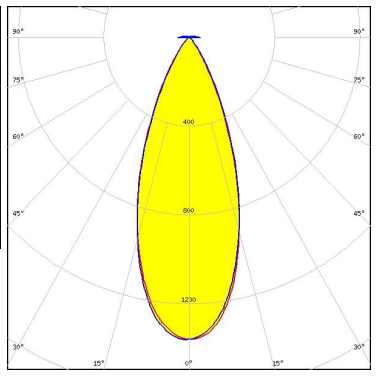
<p>COMET ELECTRONICS</p> <p>LED EASY-T FLUX 1x4 FLR XG xxx G7</p> <p>FWHM / FWTM 41.0° / 68.0°</p> <p>Efficiency 67 %</p> <p>Peak intensity 1.3 cd/m</p> <p>LEDs/each optic 1</p> <p>Light colour White</p> <p>Required components: C15028_FLORENTINA-4X1-SHD</p>		
<p>COMET ELECTRONICS</p> <p>LED EASY-T FLUX 1x4 FLR XT xxx G5</p> <p>FWHM / FWTM 39.0° / 67.0°</p> <p>Efficiency 68 %</p> <p>Peak intensity 1.4 cd/m</p> <p>LEDs/each optic 1</p> <p>Light colour White</p> <p>Required components: C15028_FLORENTINA-4X1-SHD</p>		
<p>CREE LEDs</p> <p>LED XP-L2</p> <p>FWHM / FWTM 43.0° / 72.0°</p> <p>Efficiency 72 %</p> <p>Peak intensity 1.1 cd/m</p> <p>LEDs/each optic 1</p> <p>Light colour White</p> <p>Required components: C15690_FLORENTINA-4X1-SHD-WHT</p>		
<p>CREE LEDs</p> <p>LED XP-L2</p> <p>FWHM / FWTM 43.0° / 72.0°</p> <p>Efficiency 69 %</p> <p>Peak intensity 1.1 cd/m</p> <p>LEDs/each optic 1</p> <p>Light colour White</p> <p>Required components: C15028_FLORENTINA-4X1-SHD</p>		

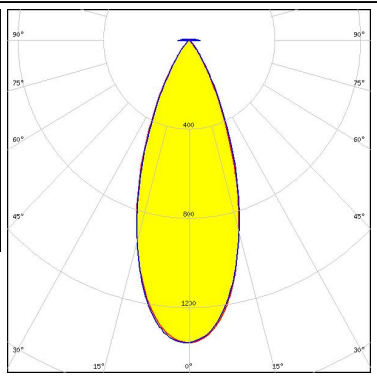
OPTICAL RESULTS (MEASURED):

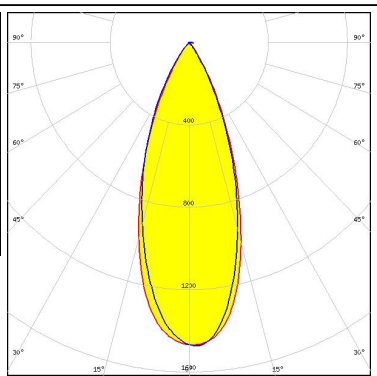
<p>CREE LEDs</p> <p>LED: XP-L2 FWHM / FWTM: 43.0° / 72.0° Efficiency: 69 % Peak intensity: 1.1 cd/lm LEDs/each optic: 1 Light colour: White Required components: C15318_FLORENCE-3R-IP-CLIP</p>		
<p>NICHIA</p> <p>LED: NVSxx19B/NVSxx19C FWHM / FWTM: 39.0° / 68.0° Efficiency: 72 % Peak intensity: 1.4 cd/lm LEDs/each optic: 1 Light colour: White Required components: C15028_FLORENTINA-4X1-SHD</p>		
<p>NICHIA</p> <p>LED: NVSxx19B/NVSxx19C FWHM / FWTM: 39.0° / 68.0° Efficiency: 72 % Peak intensity: 1.4 cd/lm LEDs/each optic: 1 Light colour: White Required components: C15198_FLORENTINA-4X1-SHD-OPEN</p>		
<p>OSRAM Opto Semiconductors</p> <p>LED: OSLOM Square CSSRM2/CSSRM3 FWHM / FWTM: 39.0° / 66.0° Efficiency: 70 % Peak intensity: 1.5 cd/lm LEDs/each optic: 1 Light colour: White Required components: C15198_FLORENTINA-4X1-SHD-OPEN</p>		

OPTICAL RESULTS (MEASURED):

OSRAM
Opto Semiconductors

LED OSLON Square CSSRM2/CSSRM3
FWHM / FWTM 36.0° / 65.0°
Efficiency 69 %
Peak intensity 1.5 cd/lm
LEDs/each optic 1
Light colour White
Required components:
C15028_FLORENTINA-4X1-SHD

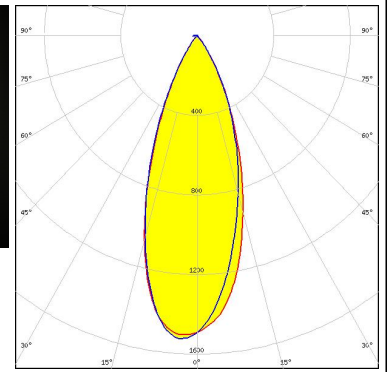

OPTICAL RESULTS (SIMULATED):



LED	XP-L HD
FWHM / FWTM	47.0° / 76.0°
Efficiency	70 %
Peak intensity	1 cd/lm
LEDs/each optic	1
Light colour	White
Required components:	
	C15028_FLORENTINA-4X1-SHD

