

62mm C-Serien Modul mit Trench/Feldstop IGBT3 und Emitter Controlled High Efficiency Diode  
62mm C-series module with trench/fieldstop IGBT3 and Emitter Controlled High Efficiency diode

**IGBT, Brems-Chopper / IGBT, Brake-Chopper**  
**Höchstzulässige Werte / Maximum Rated Values**

Kollektor-Emitter-Sperrspannung Collector-emitter voltage	$T_{vj} = 25^{\circ}\text{C}$	$V_{CES}$	1200	V
Kollektor-Dauergleichstrom Continuous DC collector current	$T_C = 80^{\circ}\text{C}, T_{vj\text{max}} = 150^{\circ}\text{C}$ $T_C = 25^{\circ}\text{C}, T_{vj\text{max}} = 150^{\circ}\text{C}$	$I_{C\text{nom}}$ $I_C$	400 580	A A
Periodischer Kollektor-Spitzenstrom Repetitive peak collector current	$t_P = 1\text{ ms}$	$I_{CRM}$	800	A
Gesamt-Verlustleistung Total power dissipation	$T_C = 25^{\circ}\text{C}, T_{vj\text{max}} = 150$	$P_{tot}$	2000	W
Gate-Emitter-Spitzenspannung Gate-emitter peak voltage		$V_{GES}$	+/-20	V

**Charakteristische Werte / Characteristic Values**

			min.	typ.	max.	
Kollektor-Emitter-Sättigungsspannung Collector-emitter saturation voltage	$I_C = 400\text{ A}, V_{GE} = 15\text{ V}$ $I_C = 400\text{ A}, V_{GE} = 15\text{ V}$	$T_{vj} = 25^{\circ}\text{C}$ $T_{vj} = 125^{\circ}\text{C}$	$V_{CE\text{sat}}$	1,70 2,00	2,15	V V
Gate-Schwellenspannung Gate threshold voltage	$I_C = 16,0\text{ mA}, V_{CE} = V_{GE}, T_{vj} = 25^{\circ}\text{C}$		$V_{G\text{Eth}}$	5,0	5,8	6,5 V
Gateladung Gate charge	$V_{GE} = -15\text{ V} \dots +15\text{ V}$		$Q_G$	3,70		$\mu\text{C}$
Interner Gatewiderstand Internal gate resistor	$T_{vj} = 25^{\circ}\text{C}$		$R_{G\text{int}}$	1,9		$\Omega$
Eingangskapazität Input capacitance	$f = 1\text{ MHz}, T_{vj} = 25^{\circ}\text{C}, V_{CE} = 25\text{ V}, V_{GE} = 0\text{ V}$		$C_{ies}$	28,0		nF
Rückwirkungskapazität Reverse transfer capacitance	$f = 1\text{ MHz}, T_{vj} = 25^{\circ}\text{C}, V_{CE} = 25\text{ V}, V_{GE} = 0\text{ V}$		$C_{res}$	1,10		nF
Kollektor-Emitter-Reststrom Collector-emitter cut-off current	$V_{CE} = 1200\text{ V}, V_{GE} = 0\text{ V}, T_{vj} = 25^{\circ}\text{C}$		$I_{CES}$		5,0	mA
Gate-Emitter-Reststrom Gate-emitter leakage current	$V_{CE} = 0\text{ V}, V_{GE} = 20\text{ V}, T_{vj} = 25^{\circ}\text{C}$		$I_{GES}$		400	nA
Einschaltverzögerungszeit, induktive Last Turn-on delay time, inductive load	$I_C = 400\text{ A}, V_{CE} = 600\text{ V}$ $V_{GE} = \pm 15\text{ V}$ $R_{Gon} = 1,8\ \Omega$	$T_{vj} = 25^{\circ}\text{C}$ $T_{vj} = 125^{\circ}\text{C}$	$t_{d\text{on}}$	0,25 0,30		$\mu\text{s}$ $\mu\text{s}$
Anstiegszeit, induktive Last Rise time, inductive load	$I_C = 400\text{ A}, V_{CE} = 600\text{ V}$ $V_{GE} = \pm 15\text{ V}$ $R_{Gon} = 1,8\ \Omega$	$T_{vj} = 25^{\circ}\text{C}$ $T_{vj} = 125^{\circ}\text{C}$	$t_r$	0,09 0,10		$\mu\text{s}$ $\mu\text{s}$
Abschaltverzögerungszeit, induktive Last Turn-off delay time, inductive load	$I_C = 400\text{ A}, V_{CE} = 600\text{ V}$ $V_{GE} = \pm 15\text{ V}$ $R_{Goff} = 1,8\ \Omega$	$T_{vj} = 25^{\circ}\text{C}$ $T_{vj} = 125^{\circ}\text{C}$	$t_{d\text{off}}$	0,55 0,65		$\mu\text{s}$ $\mu\text{s}$
Fallzeit, induktive Last Fall time, inductive load	$I_C = 400\text{ A}, V_{CE} = 600\text{ V}$ $V_{GE} = \pm 15\text{ V}$ $R_{Goff} = 1,8\ \Omega$	$T_{vj} = 25^{\circ}\text{C}$ $T_{vj} = 125^{\circ}\text{C}$	$t_f$	0,13 0,18		$\mu\text{s}$ $\mu\text{s}$
Einschaltverlustenergie pro Puls Turn-on energy loss per pulse	$I_C = 400\text{ A}, V_{CE} = 600\text{ V}, L_S = 80\text{ nH}$ $V_{GE} = \pm 15\text{ V}, di/dt = 6000\text{ A}/\mu\text{s}$ $R_{Gon} = 1,8\ \Omega$	$T_{vj} = 25^{\circ}\text{C}$ $T_{vj} = 125^{\circ}\text{C}$	$E_{on}$	17,0 25,0		mJ mJ
Abschaltverlustenergie pro Puls Turn-off energy loss per pulse	$I_C = 400\text{ A}, V_{CE} = 600\text{ V}, L_S = 80\text{ nH}$ $V_{GE} = \pm 15\text{ V}, du/dt = 4000\text{ V}/\mu\text{s}$ $R_{Goff} = 1,8\ \Omega$	$T_{vj} = 25^{\circ}\text{C}$ $T_{vj} = 125^{\circ}\text{C}$	$E_{off}$	42,0 62,0		mJ mJ
Kurzschlußverhalten SC data	$V_{GE} \leq 15\text{ V}, V_{CC} = 900\text{ V}$ $V_{CE\text{max}} = V_{CES} - L_{SCE} \cdot di/dt$	$t_P \leq 10\ \mu\text{s}, T_{vj} = 125^{\circ}\text{C}$	$I_{SC}$	1600		A
Wärmewiderstand, Chip bis Gehäuse Thermal resistance, junction to case	pro IGBT / per IGBT		$R_{thJC}$		0,062	K/W
Wärmewiderstand, Gehäuse bis Kühlkörper Thermal resistance, case to heatsink	pro IGBT / per IGBT $\lambda_{\text{Paste}} = 1\text{ W}/(\text{m}\cdot\text{K}) / \lambda_{\text{grease}} = 1\text{ W}/(\text{m}\cdot\text{K})$		$R_{thCH}$	0,03		K/W
Temperatur im Schaltbetrieb Temperature under switching conditions			$T_{vj\text{op}}$	-40	125	$^{\circ}\text{C}$

prepared by: MK	date of publication: 2013-10-03
approved by: WR	revision: 3.0



**Diode, Brems-Chopper / Diode, Brake-Chopper**  
**Höchstzulässige Werte / Maximum Rated Values**

Periodische Spitzensperrspannung Repetitive peak reverse voltage	$T_{vj} = 25^{\circ}\text{C}$	$V_{RRM}$	1200	V
Dauergleichstrom Continuous DC forward current		$I_F$	400	A
Periodischer Spitzenstrom Repetitive peak forward current	$t_P = 1\text{ ms}$	$I_{FRM}$	800	A
Grenzlastintegral $I^2t$ - value	$V_R = 0\text{ V}, t_P = 10\text{ ms}, T_{vj} = 125^{\circ}\text{C}$	$I^2t$	34000	$\text{A}^2\text{s}$

**Charakteristische Werte / Characteristic Values**

			min.	typ.	max.	
Durchlassspannung Forward voltage	$I_F = 400\text{ A}, V_{GE} = 0\text{ V}$ $I_F = 400\text{ A}, V_{GE} = 0\text{ V}$	$T_{vj} = 25^{\circ}\text{C}$ $T_{vj} = 125^{\circ}\text{C}$	$V_F$	1,65 1,65	2,15	V V
Rückstromspitze Peak reverse recovery current	$I_F = 400\text{ A}, -di_F/dt = 6000\text{ A}/\mu\text{s} (T_{vj}=125^{\circ}\text{C})$ $V_R = 600\text{ V}$	$T_{vj} = 25^{\circ}\text{C}$ $T_{vj} = 125^{\circ}\text{C}$	$I_{RM}$	400 480		A A
Sperrverzögerungsladung Recovered charge	$I_F = 400\text{ A}, -di_F/dt = 6000\text{ A}/\mu\text{s} (T_{vj}=125^{\circ}\text{C})$ $V_R = 600\text{ V}$	$T_{vj} = 25^{\circ}\text{C}$ $T_{vj} = 125^{\circ}\text{C}$	$Q_r$	44,0 80,0		$\mu\text{C}$ $\mu\text{C}$
Abschaltenergie pro Puls Reverse recovery energy	$I_F = 400\text{ A}, -di_F/dt = 6000\text{ A}/\mu\text{s} (T_{vj}=125^{\circ}\text{C})$ $V_R = 600\text{ V}$	$T_{vj} = 25^{\circ}\text{C}$ $T_{vj} = 125^{\circ}\text{C}$	$E_{rec}$	20,0 37,0		mJ mJ
Wärmewiderstand, Chip bis Gehäuse Thermal resistance, junction to case	pro Diode / per diode		$R_{thJC}$		0,11	K/W
Wärmewiderstand, Gehäuse bis Kühlkörper Thermal resistance, case to heatsink	pro Diode / per diode $\lambda_{\text{Paste}} = 1\text{ W}/(\text{m}\cdot\text{K}) / \lambda_{\text{grease}} = 1\text{ W}/(\text{m}\cdot\text{K})$		$R_{thCH}$	0,06		K/W
Temperatur im Schaltbetrieb Temperature under switching conditions			$T_{vj\text{ op}}$	-40	125	$^{\circ}\text{C}$

**Diode, Revers / Diode, Reverse**

**Höchstzulässige Werte / Maximum Rated Values**

Periodische Spitzensperrspannung Repetitive peak reverse voltage	$T_{vj} = 25^{\circ}\text{C}$	$V_{RRM}$	1200	V
Dauergleichstrom Continuous DC forward current		$I_F$	400	A
Periodischer Spitzenstrom Repetitive peak forward current	$t_P = 1\text{ ms}$	$I_{FRM}$	800	A
Grenzlastintegral $I^2t$ - value	$V_R = 0\text{ V}, t_P = 10\text{ ms}, T_{vj} = 125^{\circ}\text{C}$	$I^2t$	34000	$\text{A}^2\text{s}$

**Charakteristische Werte / Characteristic Values**

			min.	typ.	max.	
Durchlassspannung Forward voltage	$I_F = 400\text{ A}, V_{GE} = 0\text{ V}$ $I_F = 400\text{ A}, V_{GE} = 0\text{ V}$	$T_{vj} = 25^{\circ}\text{C}$ $T_{vj} = 125^{\circ}\text{C}$	$V_F$	1,65 1,65	2,15	V V
Wärmewiderstand, Chip bis Gehäuse Thermal resistance, junction to case	pro Diode / per diode		$R_{thJC}$		0,11	K/W
Wärmewiderstand, Gehäuse bis Kühlkörper Thermal resistance, case to heatsink	pro Diode / per diode $\lambda_{\text{Paste}} = 1\text{ W}/(\text{m}\cdot\text{K}) / \lambda_{\text{grease}} = 1\text{ W}/(\text{m}\cdot\text{K})$		$R_{thCH}$	0,06		K/W
Temperatur im Schaltbetrieb Temperature under switching conditions			$T_{vj\text{ op}}$	-40	125	$^{\circ}\text{C}$

prepared by: MK	date of publication: 2013-10-03
approved by: WR	revision: 3.0



**Modul / Module**

Isolations-Prüfspannung Isolation test voltage	RMS, f = 50 Hz, t = 1 min.	V <sub>ISOL</sub>	2,5		kV
Material Modulgrundplatte Material of module baseplate			Cu		
Innere Isolation Internal isolation	Basisisolierung (Schutzklasse 1, EN61140) basic insulation (class 1, IEC 61140)		Al <sub>2</sub> O <sub>3</sub>		
Kriechstrecke Creepage distance	Kontakt - Kühlkörper / terminal to heatsink Kontakt - Kontakt / terminal to terminal		29,0 23,0		mm
Luftstrecke Clearance	Kontakt - Kühlkörper / terminal to heatsink Kontakt - Kontakt / terminal to terminal		23,0 11,0		mm
Vergleichszahl der Kriechwegbildung Comperative tracking index		CTI	> 400		
			min.	typ.	max.
Wärmewiderstand, Gehäuse bis Kühlkörper Thermal resistance, case to heatsink	pro Modul / per module $\lambda_{\text{Paste}} = 1 \text{ W/(m}\cdot\text{K)} / \lambda_{\text{grease}} = 1 \text{ W/(m}\cdot\text{K)}$	R <sub>thCH</sub>		0,01	K/W
Modulstreuintduktivität Stray inductance module		L <sub>sCE</sub>		20	nH
Modulleitungswiderstand, Anschlüsse - Chip Module lead resistance, terminals - chip	T <sub>c</sub> = 25°C, pro Schalter / per switch	R <sub>CC+EE'</sub>		0,70	mΩ
Lagertemperatur Storage temperature		T <sub>stg</sub>	-40		125 °C
Anzugsdrehmoment f. Modulmontage Mounting torque for modul mounting	Schraube M6 - Montage gem. gültiger Applikationsschrift Screw M6 - Mounting according to valid application note	M	3,00	-	6,00 Nm
Anzugsdrehmoment f. elektr. Anschlüsse Terminal connection torque	Schraube M6 - Montage gem. gültiger Applikationsschrift Screw M6 - Mounting according to valid application note	M	2,5	-	5,0 Nm
Gewicht Weight		G		340	g

prepared by: MK	date of publication: 2013-10-03
approved by: WR	revision: 3.0

**Ausgangskennlinie IGBT, Brems-Chopper (typisch)**  
**output characteristic IGBT, Brake-Chopper (typical)**

$I_C = f(V_{CE})$   
 $V_{GE} = 15\text{ V}$

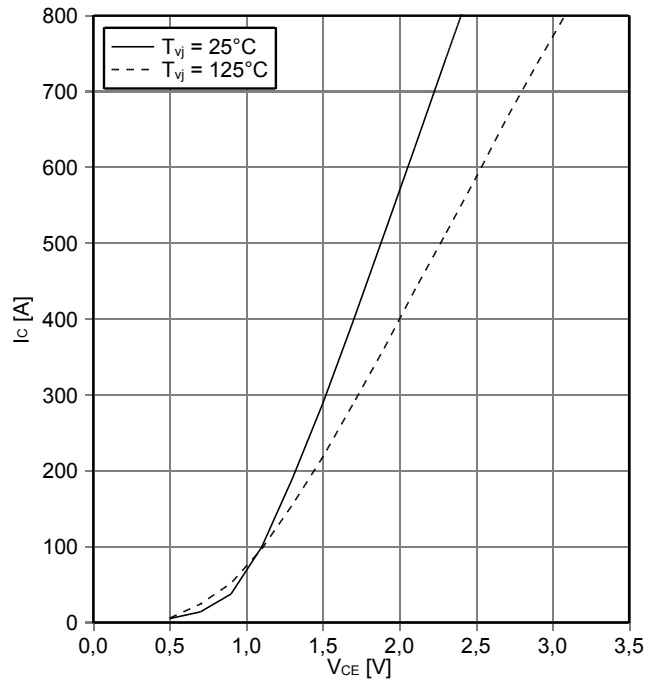

**Ausgangskennlinienfeld IGBT, Brems-Chopper (typisch)**  
**output characteristic IGBT, Brake-Chopper (typical)**

$I_C = f(V_{CE})$   
 $T_{vj} = 125^\circ\text{C}$

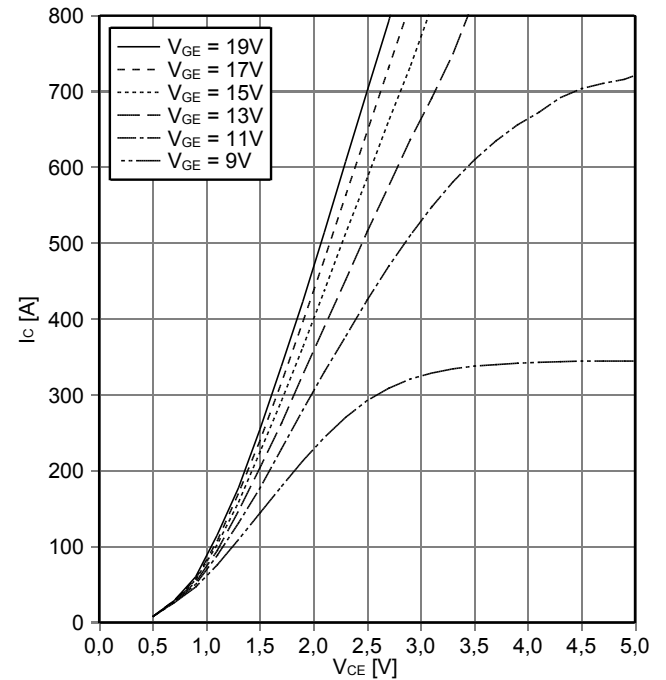

**Übertragungscharakteristik IGBT, Brems-Chopper (typisch)**  
**transfer characteristic IGBT, Brake-Chopper (typical)**

$I_C = f(V_{GE})$   
 $V_{CE} = 20\text{ V}$

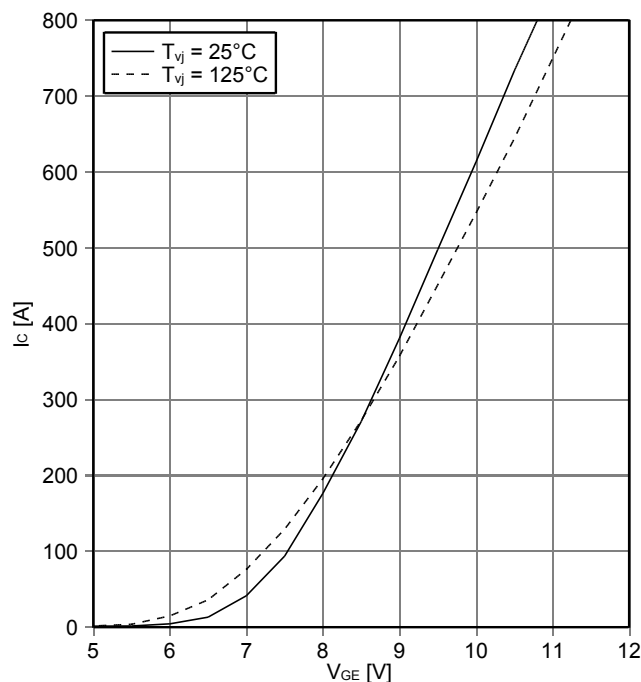

**Schaltverluste IGBT, Brems-Chopper (typisch)**  
**switching losses IGBT, Brake-Chopper (typical)**

$E_{on} = f(I_C), E_{off} = f(I_C)$   
 $V_{GE} = \pm 15\text{ V}, R_{Gon} = 1.8\ \Omega, R_{Goff} = 1.8\ \Omega, V_{CE} = 600\text{ V}$

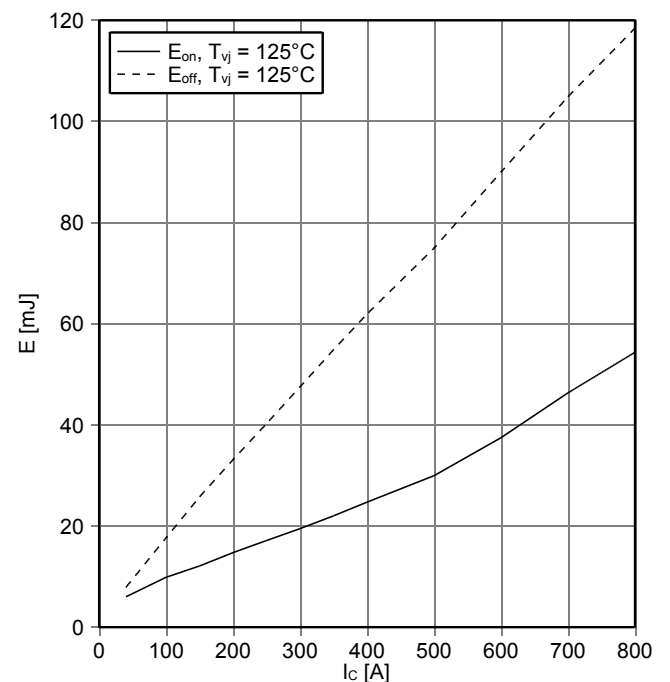

prepared by: MK	date of publication: 2013-10-03
approved by: WR	revision: 3.0



**Schaltverluste IGBT, Brems-Chopper (typisch)**  
**switching losses IGBT, Brake-Chopper (typical)**

$E_{on} = f(R_G), E_{off} = f(R_G)$   
 $V_{GE} = \pm 15 V, I_C = 400 A, V_{CE} = 600 V$

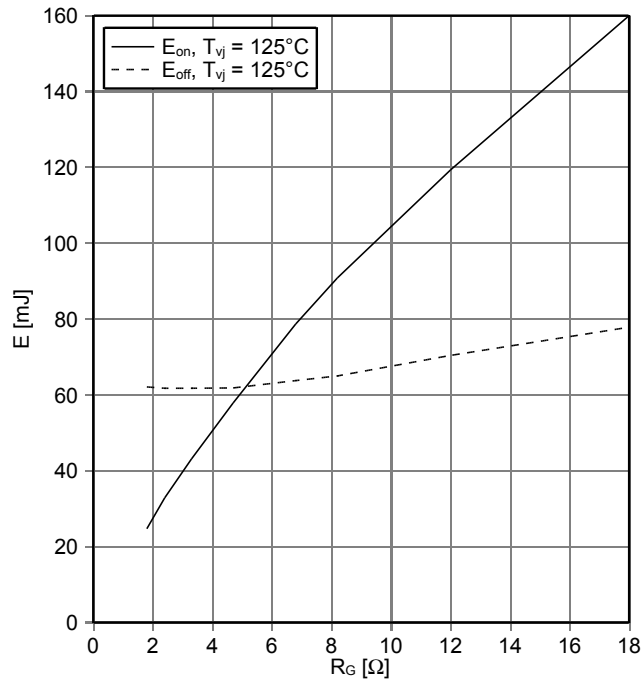

**Transienter Wärmewiderstand IGBT, Brems-Chopper**

**transient thermal impedance IGBT, Brake-Chopper**  
 $Z_{thJC} = f(t)$

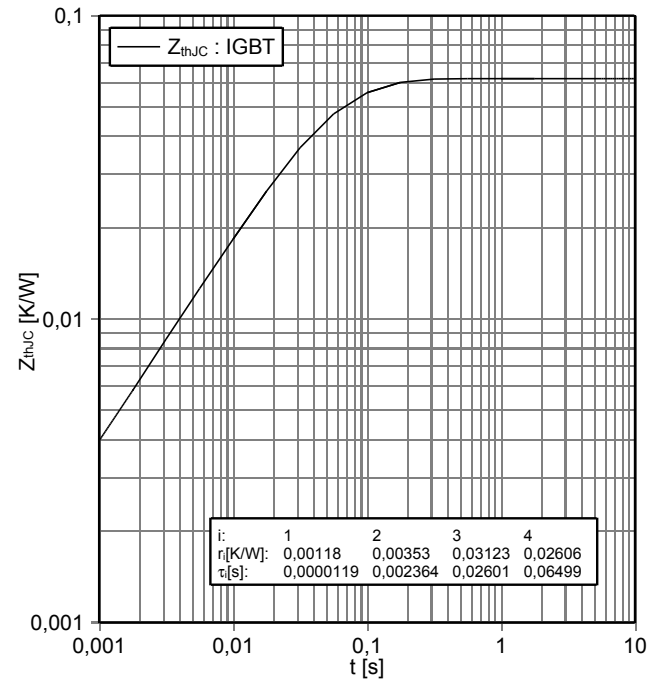

**Sicherer Rückw.-Arbeitsber. IGBT, Brems-Chopper (RBSOA)**  
**reverse bias safe operating area IGBT, Brake-Chopper (RBSOA)**

$I_C = f(V_{CE})$   
 $V_{GE} = \pm 15 V, R_{Goff} = 1.8 \Omega, T_{vj} = 125^\circ C$

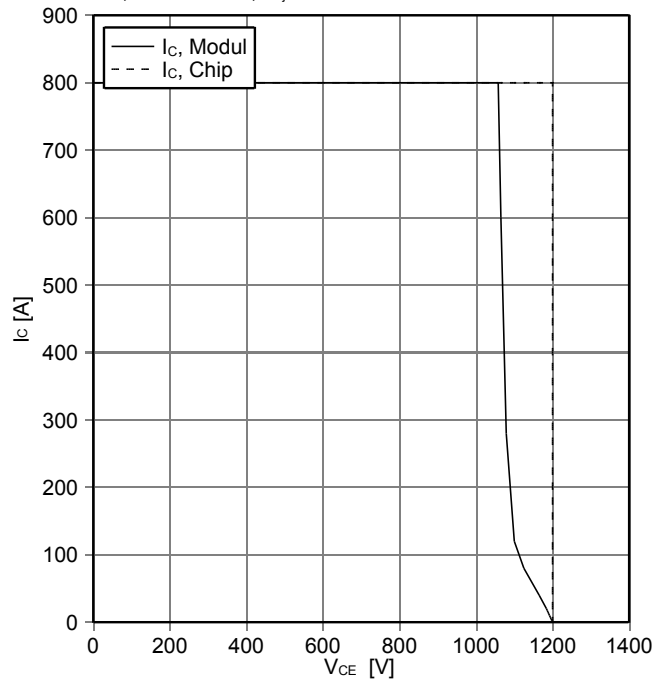

**Durchlasskennlinie der Diode, Brems-Chopper (typisch)**  
**forward characteristic of Diode, Brake-Chopper (typical)**

$I_F = f(V_F)$

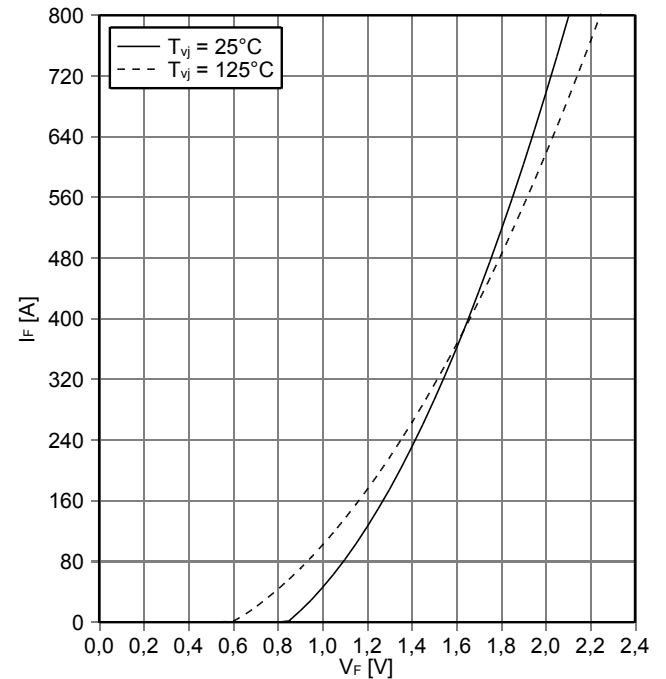

prepared by: MK	date of publication: 2013-10-03
approved by: WR	revision: 3.0



**Schaltverluste Diode, Brems-Chopper (typisch)**  
**switching losses Diode, Brake-Chopper (typical)**

$E_{rec} = f(I_F)$   
 $R_{Gon} = 1.8 \Omega, V_{CE} = 600 V$

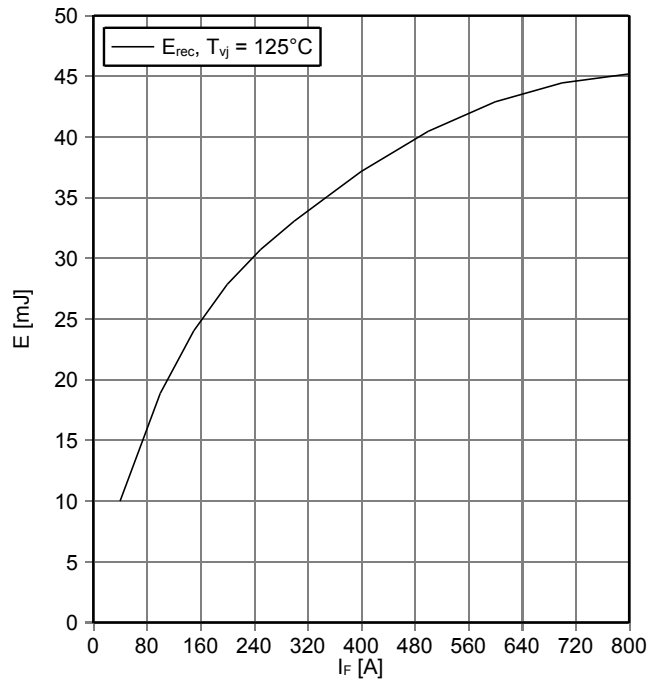

**Schaltverluste Diode, Brems-Chopper (typisch)**  
**switching losses Diode, Brake-Chopper (typical)**

$E_{rec} = f(R_G)$   
 $I_F = 400 A, V_{CE} = 600 V$

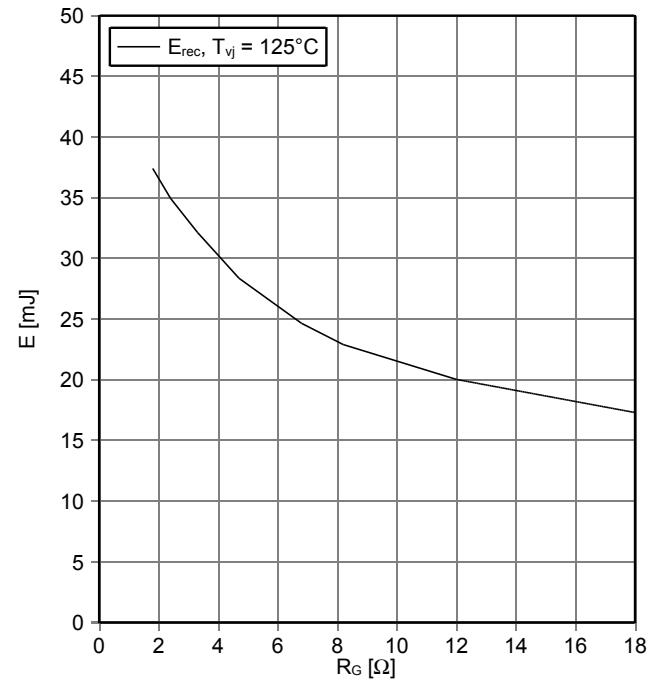

**Transienter Wärmewiderstand Diode, Brems-Chopper**  
**transient thermal impedance Diode, Brake-Chopper**

$Z_{thJC} = f(t)$

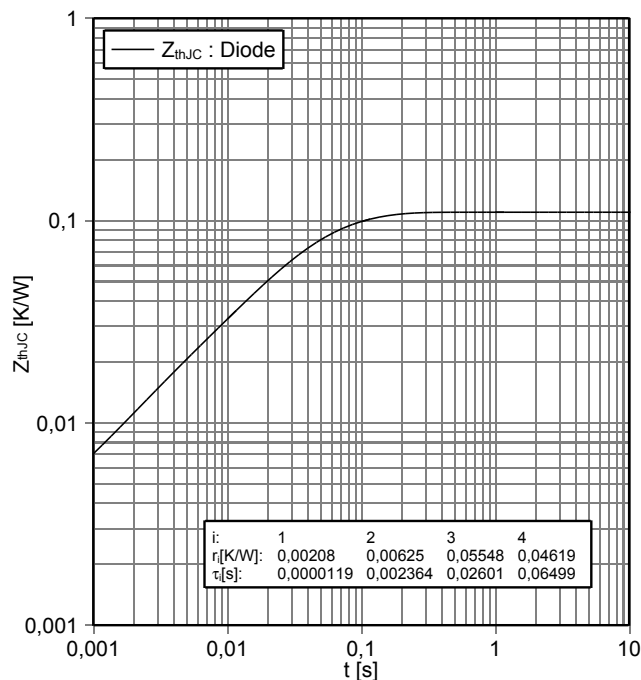

i	1	2	3	4
r <sub>i</sub> [K/W]	0,00208	0,00625	0,05548	0,04619
τ <sub>i</sub> [s]	0,0000119	0,002364	0,02601	0,06499

**Durchlasskennlinie der Diode, Revers (typisch)**  
**forward characteristic of Diode, Reverse (typical)**

$I_F = f(V_F)$

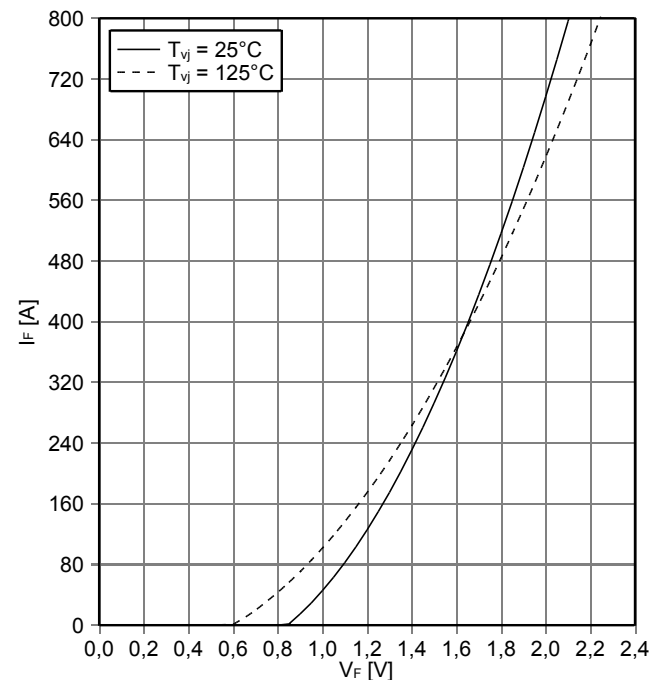

prepared by: MK	date of publication: 2013-10-03
approved by: WR	revision: 3.0



**Transienter Wärmewiderstand Diode, Revers**  
**transient thermal impedance Diode, Reverse**

$Z_{thJC} = f(t)$

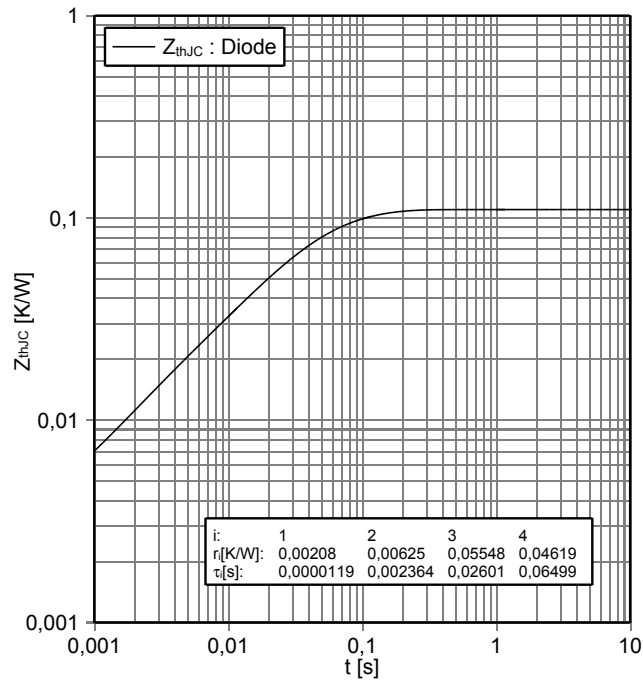

prepared by: MK	date of publication: 2013-10-03
approved by: WR	revision: 3.0

### Schaltplan / circuit\_diagram\_headline

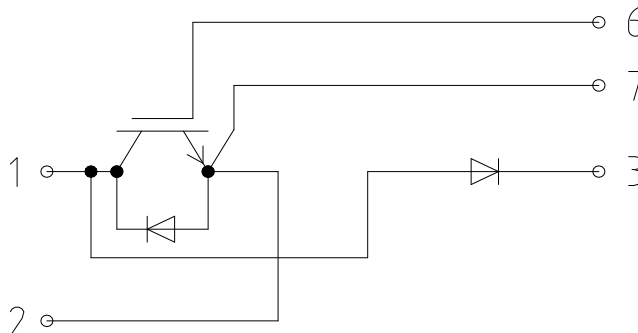

### Gehäuseabmessungen / package outlines

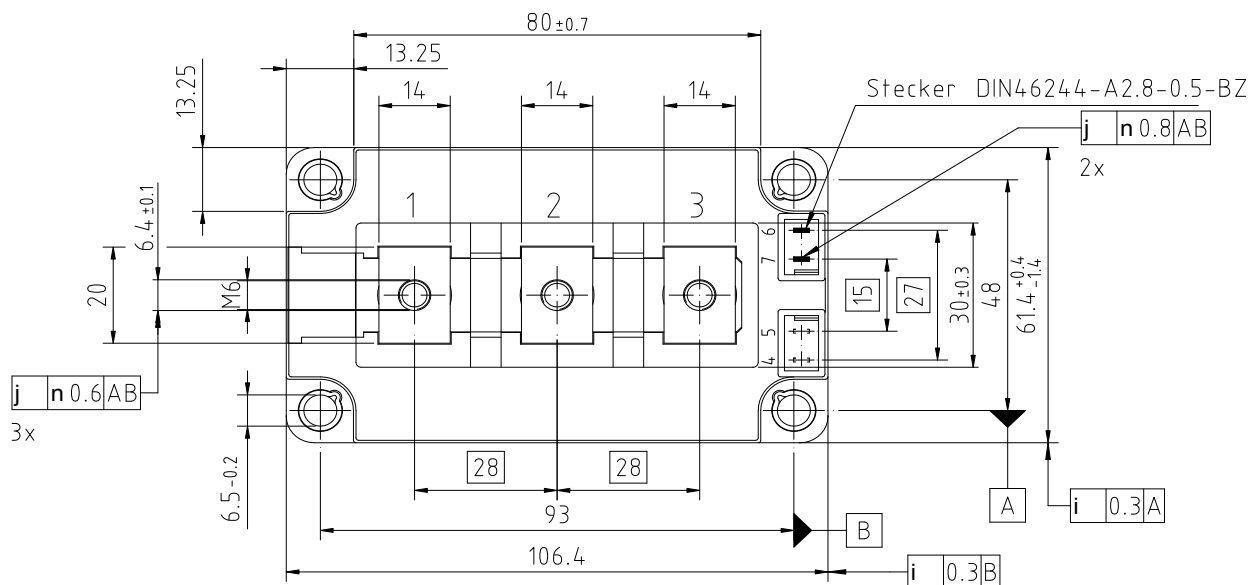
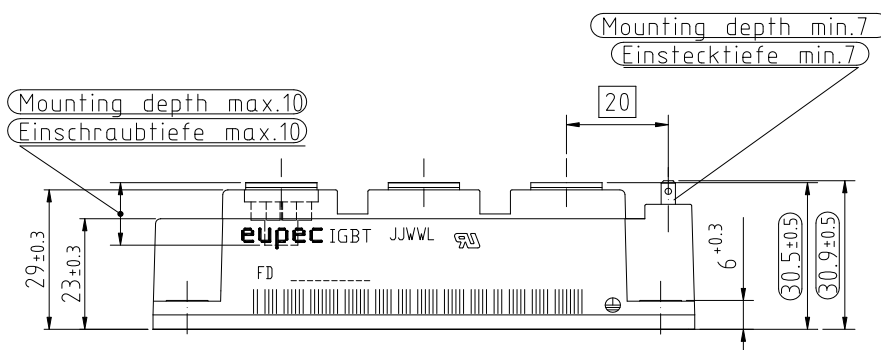

Freimaßtoleranzen  
nach ISO2768 mH

General tolerance  
ISO2768 mH

Az24

prepared by: MK	date of publication: 2013-10-03
approved by: WR	revision: 3.0