

XHP™3 module with Trench/Fieldstop IGBT3 and emitter controlled 3 diode

Features

- Electrical features
 - $V_{CES} = 6500 \text{ V}$
 - $I_{C\text{nom}} = 225 \text{ A} / I_{CRM} = 450 \text{ A}$
 - High dynamic robustness
 - Low $V_{CE,\text{sat}}$
 - Trench IGBT 3
- Mechanical features
 - Package with CTI > 600
 - Package with enhanced insulation of 10.4 kV AC 60 s
 - ALSiC base plate for increased thermal cycling capability
 - Extended storage temperature down to $T_{\text{stg}} = -55 \text{ °C}$
 - High creepage and clearance distances
 - Housing material compliant with the classification R23 (HL3) of the EN45545-2 “Fire protection of railway vehicles”



Potential applications

- Traction drives
- Medium-voltage converters

Product validation

- Qualified for industrial applications according to the relevant tests of IEC 60747, 60749 and 60068

Description

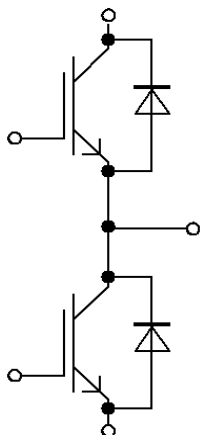

Table of contents

	Description	1
	Features	1
	Potential applications	1
	Product validation	1
	Table of contents	2
1	Package	3
2	IGBT, Inverter	3
3	Diode, Inverter	5
4	Characteristics diagrams	7
5	Circuit diagram	11
6	Package outlines	12
7	Module label code	13
	Revision history	14
	Disclaimer	15

1 Package

Table 1 Insulation coordination

Parameter	Symbol	Note or test condition	Values	Unit
Isolation test voltage	V_{ISOL}	RMS, $f = 50$ Hz, $t = 60$ s	10.4	kV
Partial discharge extinction voltage	V_{isol}	RMS, $f = 50$ Hz, Q_{PD} typ. 10 pC	5.1	kV
DC stability	$V_{CE(D)}$	$T_{vj}=25^{\circ}\text{C}$, 100 Fit	3800	V
Material of module baseplate			AlSiC	
Creepage distance	d_{Creep}	terminal to heatsink	53.0	mm
Creepage distance	d_{Creep}	terminal to terminal	53.0	mm
Clearance	d_{Clear}	terminal to heatsink	36.0	mm
Clearance	d_{Clear}	terminal to terminal	26.0	mm
Comparative tracking index	CTI		> 600	

Table 2 Characteristic values

Parameter	Symbol	Note or test condition	Values			Unit	
			Min.	Typ.	Max.		
Stray inductance module	L_{sCE}			25		nH	
Module lead resistance, terminals - chip	$R_{AA'+CC'}$	$T_C=25^{\circ}\text{C}$, per switch		0.33		mΩ	
Module lead resistance, terminals - chip	$R_{CC'+EE'}$	$T_C=25^{\circ}\text{C}$, per switch		0.42		mΩ	
Storage temperature	T_{stg}		-55		125	°C	
Mounting torque for module mounting	M	- Mounting according to valid application note	M6, Screw	4.25		5.75	Nm
Terminal connection torque	M	- Mounting according to valid application note	M3, Screw	0.9		1.1	Nm
			M8, Screw	8		10	
Weight	G			700		g	

2 IGBT, Inverter

Table 3 Maximum rated values

Parameter	Symbol	Note or test condition	Values	Unit	
Collector-emitter voltage	V_{CES}		$T_{vj} = -50^{\circ}\text{C}$	5900	V
			$T_{vj} = 125^{\circ}\text{C}$	6500	
Continuous DC collector current	I_{CDC}	$T_{vj\ max} = 125^{\circ}\text{C}$	$T_C = 80^{\circ}\text{C}$	225	A

(table continues...)

Table 3 (continued) Maximum rated values

Parameter	Symbol	Note or test condition	Values	Unit
Repetitive peak collector current	I_{CRM}	t_p limited by $T_{vj\ op}$	450	A
Gate-emitter peak voltage	V_{GES}		±20	V

Table 4 Characteristic values

Parameter	Symbol	Note or test condition	Values			Unit
			Min.	Typ.	Max.	
Collector-emitter saturation voltage	$V_{CE\ sat}$	$I_C = 225\ A, V_{GE} = 15\ V$	$T_{vj} = 25\ ^\circ C$	3.00	3.40	V
			$T_{vj} = 125\ ^\circ C$	3.70	4.20	
Gate threshold voltage	V_{GEth}	$I_C = 33\ mA, V_{CE} = V_{GE}, T_{vj} = 25\ ^\circ C$	5.40	6	6.60	V
Gate charge	Q_G	$V_{GE} = \pm 15\ V, V_{CE} = 3600\ V$		10.5		μC
Internal gate resistor	R_{Gint}	$T_{vj} = 25\ ^\circ C$		0.67		Ω
Input capacitance	C_{ies}	$f = 100\ kHz, T_{vj} = 25\ ^\circ C, V_{CE} = 25\ V, V_{GE} = 0\ V$		65.6		nF
Reverse transfer capacitance	C_{res}	$f = 100\ kHz, T_{vj} = 25\ ^\circ C, V_{CE} = 25\ V, V_{GE} = 0\ V$		1		nF
Collector-emitter cut-off current	I_{CES}	$V_{CE} = 6500\ V, V_{GE} = 0\ V$	$T_{vj} = 25\ ^\circ C$		5	mA
Gate-emitter leakage current	I_{GES}	$V_{CE} = 0\ V, V_{GE} = 20\ V, T_{vj} = 25\ ^\circ C$			400	nA
Turn-on delay time (inductive load)	t_{don}	$I_C = 225\ A, V_{CE} = 3600\ V, V_{GE} = \pm 15\ V, R_{Gon} = 4.7\ \Omega$	$T_{vj} = 25\ ^\circ C$	0.240		μs
			$T_{vj} = 125\ ^\circ C$	0.240		
Rise time (inductive load)	t_r	$I_C = 225\ A, V_{CE} = 3600\ V, V_{GE} = \pm 15\ V, R_{Gon} = 4.7\ \Omega$	$T_{vj} = 25\ ^\circ C$	0.070		μs
			$T_{vj} = 125\ ^\circ C$	0.080		
Turn-off delay time (inductive load)	t_{doff}	$I_C = 225\ A, V_{CE} = 3600\ V, V_{GE} = \pm 15\ V, R_{Goff} = 22\ \Omega$	$T_{vj} = 25\ ^\circ C$	6.000		μs
			$T_{vj} = 125\ ^\circ C$	6.400		
Fall time (inductive load)	t_f	$I_C = 225\ A, V_{CE} = 3600\ V, V_{GE} = \pm 15\ V, R_{Goff} = 22\ \Omega$	$T_{vj} = 25\ ^\circ C$	0.950		μs
			$T_{vj} = 125\ ^\circ C$	2.000		
Turn-on energy loss per pulse	E_{on}	$I_C = 225\ A, V_{CE} = 3600\ V, L_\sigma = 85\ nH, V_{GE} = \pm 15\ V, R_{Gon} = 4.7\ \Omega, di/dt = 2200\ A/\mu s (T_{vj} = 125\ ^\circ C)$	$T_{vj} = 25\ ^\circ C$	1230		mJ
			$T_{vj} = 125\ ^\circ C$	1710		
Turn-off energy loss per pulse	E_{off}	$I_C = 225\ A, V_{CE} = 3600\ V, L_\sigma = 85\ nH, V_{GE} = \pm 15\ V, R_{Goff} = 22\ \Omega, dv/dt = 2100\ V/\mu s (T_{vj} = 125\ ^\circ C)$	$T_{vj} = 25\ ^\circ C$	875		mJ
			$T_{vj} = 125\ ^\circ C$	1170		
SC data	I_{SC}	$V_{GE} \leq 15\ V, V_{CC} = 4500\ V, V_{CEmax} = V_{CES} - L_{sCE} * di/dt$	$t_p \leq 10\ \mu s, T_{vj} = 125\ ^\circ C$	1300		A

(table continues...)

Table 4 (continued) Characteristic values

Parameter	Symbol	Note or test condition	Values			Unit
			Min.	Typ.	Max.	
Thermal resistance, junction to case	R_{thJC}	per IGBT			29.1	K/kW
Thermal resistance, case to heat sink	R_{thCH}	per IGBT		21.3		K/kW
Temperature under switching conditions	T_{vjop}		-50		125	°C

3 Diode, Inverter

Table 5 Maximum rated values

Parameter	Symbol	Note or test condition	Values	Unit	
Repetitive peak reverse voltage	V_{RRM}		$T_{vj} = -50\text{ °C}$	5900	V
			$T_{vj} = 125\text{ °C}$	6500	
Continuous DC forward current	I_F		225	A	
Repetitive peak forward current	I_{FRM}	$t_p = 1\text{ ms}$	450	A	
I^2t - value	I^2t	$t_p = 10\text{ ms}, V_R = 0\text{ V}$	$T_{vj} = 125\text{ °C}$	45.2	kA ² s
Maximum power dissipation	P_{RQM}		$T_{vj} = 125\text{ °C}$	1000	kW
Minimum turn-on time	t_{onmin}		10	µs	

Table 6 Characteristic values

Parameter	Symbol	Note or test condition	Values			Unit
			Min.	Typ.	Max.	
Forward voltage	V_F	$I_F = 225\text{ A}, V_{GE} = 0\text{ V}$	$T_{vj} = 25\text{ °C}$	3.10	3.55	V
			$T_{vj} = 125\text{ °C}$	2.85	3.25	
Peak reverse recovery current	I_{RM}	$V_R = 3600\text{ V}, I_F = 225\text{ A}, V_{GE} = -15\text{ V}, -di_F/dt = 2200\text{ A}/\mu\text{s} (T_{vj} = 125\text{ °C})$	$T_{vj} = 25\text{ °C}$	405		A
			$T_{vj} = 125\text{ °C}$	365		
Recovered charge	Q_r	$V_R = 3600\text{ V}, I_F = 225\text{ A}, V_{GE} = -15\text{ V}, -di_F/dt = 2200\text{ A}/\mu\text{s} (T_{vj} = 125\text{ °C})$	$T_{vj} = 25\text{ °C}$	255		µC
			$T_{vj} = 125\text{ °C}$	505		
Reverse recovery energy	E_{rec}	$V_R = 3600\text{ V}, I_F = 225\text{ A}, V_{GE} = -15\text{ V}, -di_F/dt = 2200\text{ A}/\mu\text{s} (T_{vj} = 125\text{ °C})$	$T_{vj} = 25\text{ °C}$	450		mJ
			$T_{vj} = 125\text{ °C}$	1070		
Thermal resistance, junction to case	R_{thJC}	per diode			51.3	K/kW

(table continues...)

Table 6 (continued) Characteristic values

Parameter	Symbol	Note or test condition	Values			Unit
			Min.	Typ.	Max.	
Thermal resistance, case to heat sink	R_{thCH}	per diode		24.2		K/kW
Temperature under switching conditions	$T_{vj\ op}$		-50		125	°C

4 Characteristics diagrams

Output characteristic (typical), IGBT, Inverter

$$I_C = f(V_{CE})$$

$$V_{GE} = 15 \text{ V}$$

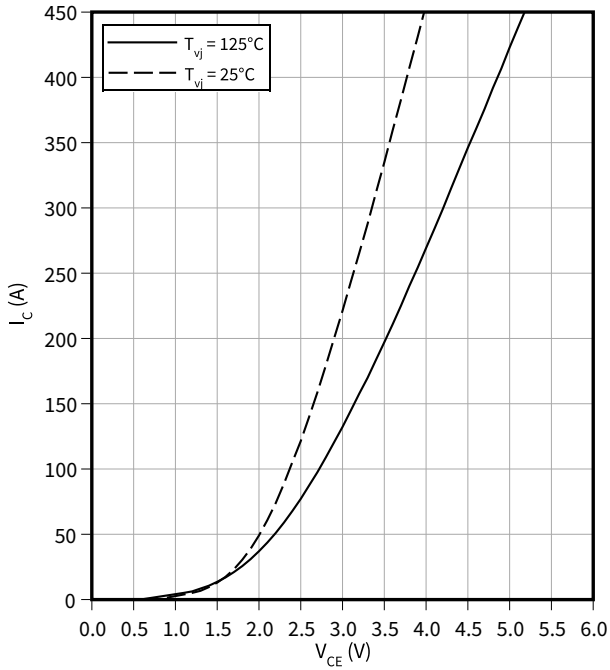

Output characteristic field (typical), IGBT, Inverter

$$I_C = f(V_{CE})$$

$$T_{vj} = 125 \text{ °C}$$

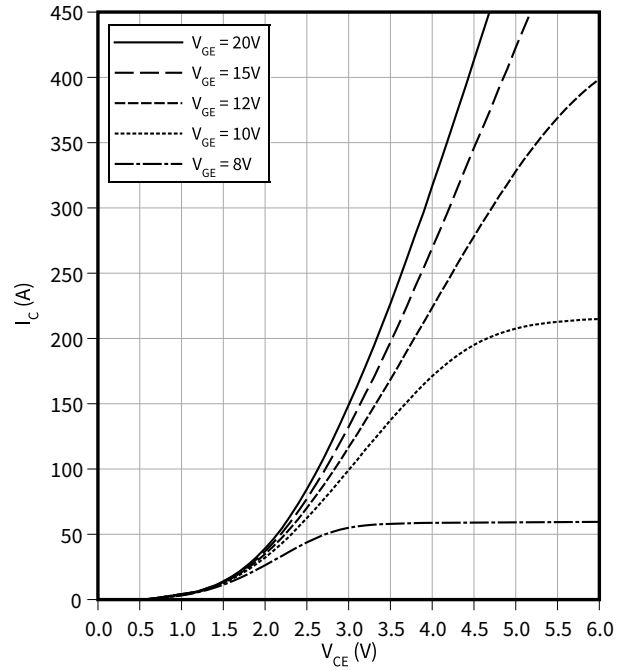

Transfer characteristic (typical), IGBT, Inverter

$$I_C = f(V_{GE})$$

$$V_{CE} = 20 \text{ V}$$

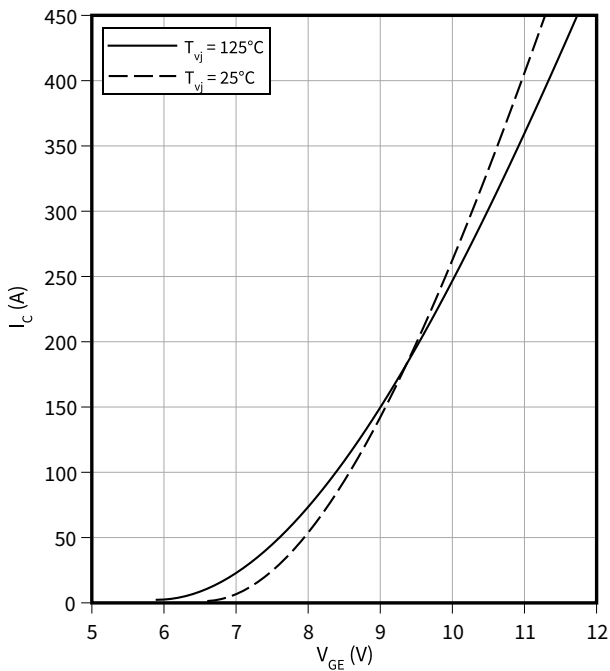

Switching losses (typical), IGBT, Inverter

$$E = f(I_C)$$

$$R_{Goff} = 22 \text{ } \Omega, R_{Gon} = 4.7 \text{ } \Omega, V_{CE} = 3600 \text{ V}, V_{GE} = \pm 15 \text{ V}$$

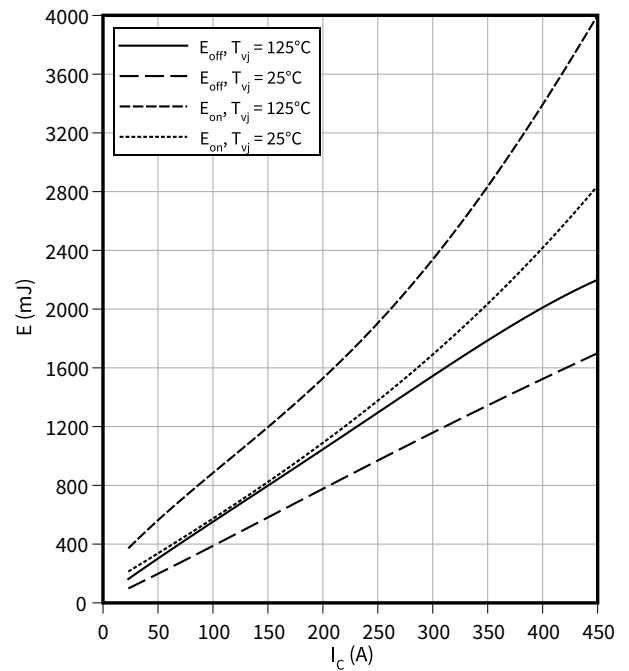

4 Characteristics diagrams

Switching losses (typical), IGBT, Inverter

$E = f(R_G)$

$I_C = 225 \text{ A}, V_{CE} = 3600 \text{ V}, V_{GE} = \pm 15 \text{ V}$

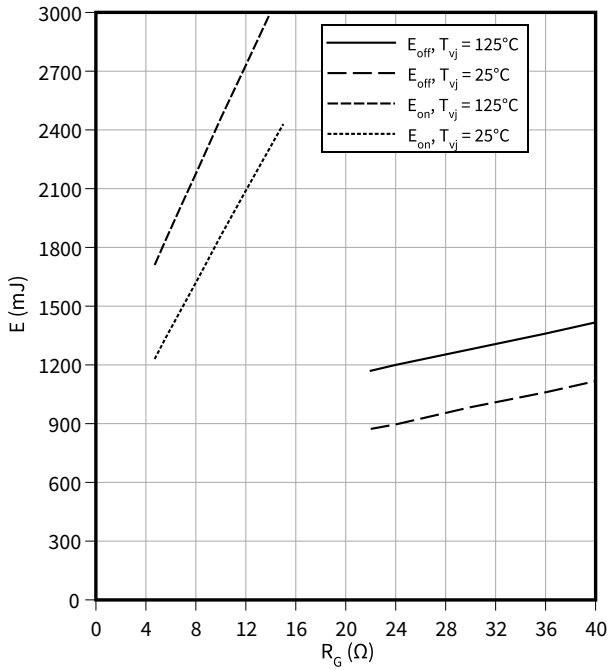

Switching times (typical), IGBT, Inverter

$t = f(I_C)$

$R_{Goff} = 22 \Omega, R_{Gon} = 4.7 \Omega, V_{CE} = 3600 \text{ V}, V_{GE} = \pm 15 \text{ V}, T_{vj} = 125^\circ\text{C}$

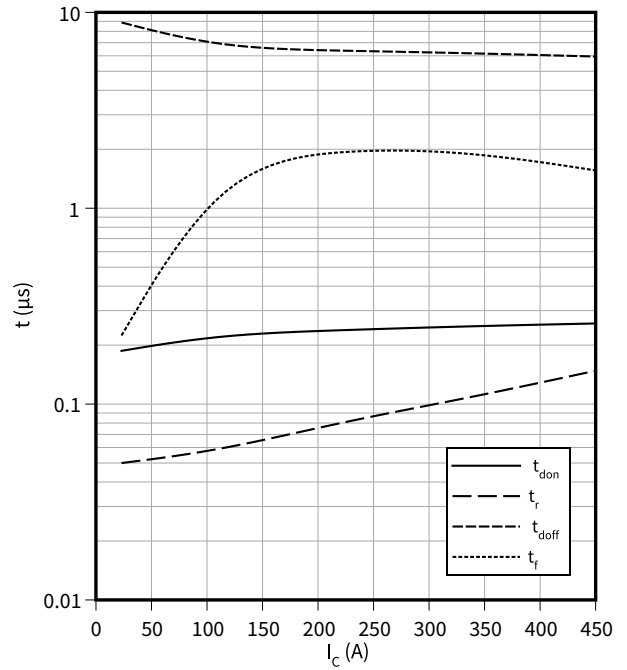

Switching times (typical), IGBT, Inverter

$t = f(R_G)$

$I_C = 225 \text{ A}, V_{CE} = 3600 \text{ V}, V_{GE} = \pm 15 \text{ V}, T_{vj} = 125^\circ\text{C}$

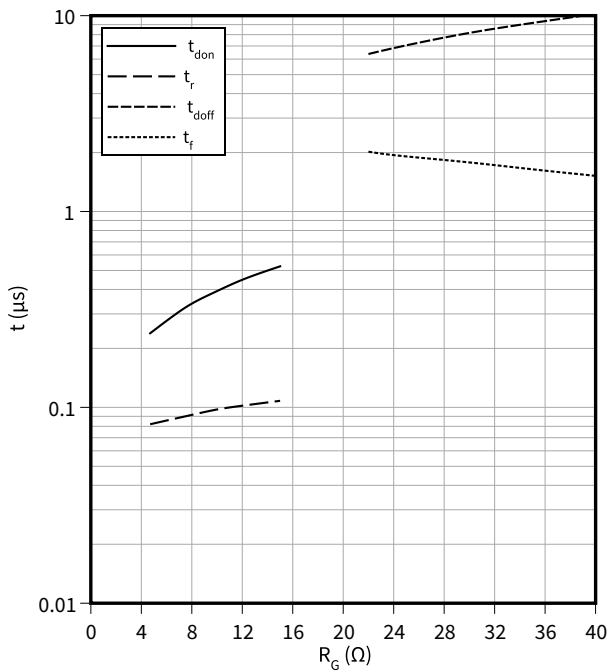

Transient thermal impedance, IGBT, Inverter

$Z_{th} = f(t)$

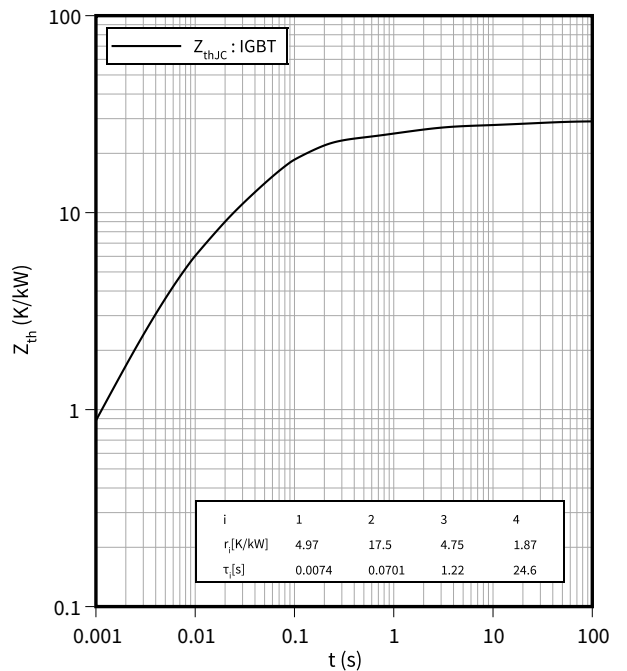

4 Characteristics diagrams

Reverse bias safe operating area (RBSOA), IGBT, Inverter

$I_C = f(V_{CE})$

$R_{Goff} = 22 \Omega$, $V_{GE} = \pm 15 \text{ V}$, $T_{vj} = 125 \text{ }^\circ\text{C}$

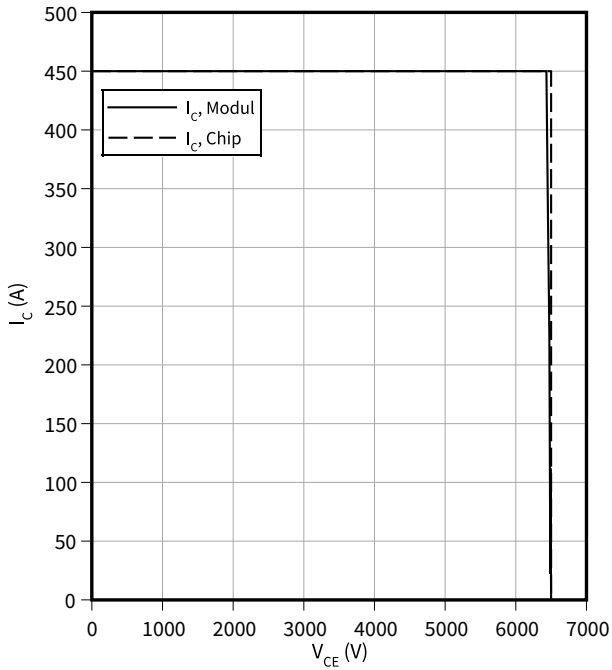

Capacity characteristic (typical), IGBT, Inverter

$C = f(V_{CE})$

$f = 100 \text{ kHz}$, $V_{GE} = 0 \text{ V}$, $T_{vj} = 25 \text{ }^\circ\text{C}$

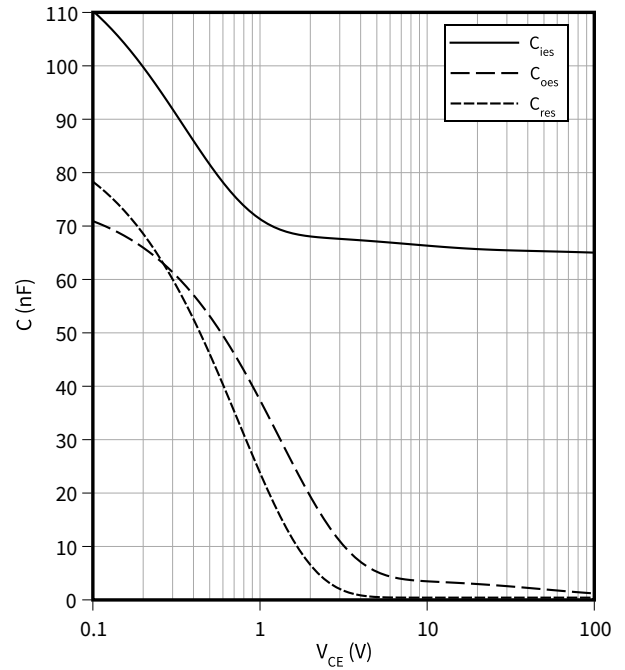

Gate charge characteristic (typical), IGBT, Inverter

$V_{GE} = f(Q_G)$

$I_C = 225 \text{ A}$, $T_{vj} = 25 \text{ }^\circ\text{C}$

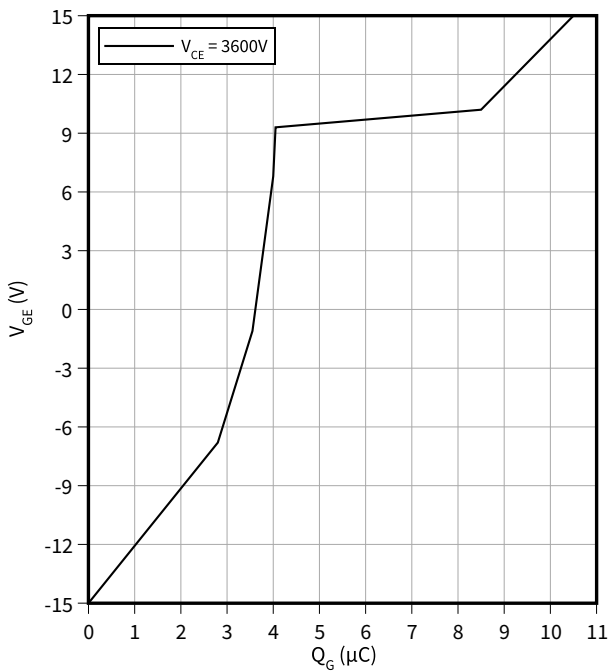

Forward characteristic (typical), Diode, Inverter

$I_F = f(V_F)$

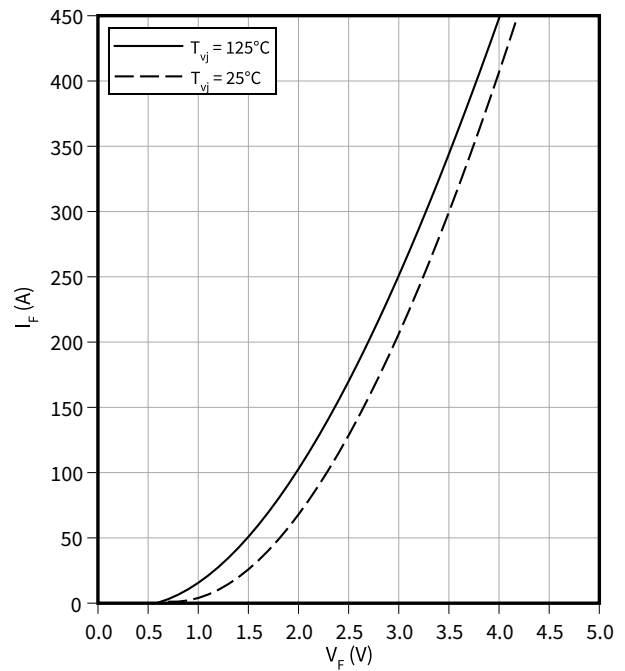

4 Characteristics diagrams

Switching losses (typical), Diode, Inverter

$E_{rec} = f(I_F)$
 $V_{CE} = 3600\text{ V}, R_{Gon} = R_{Gon}(IGBT)$

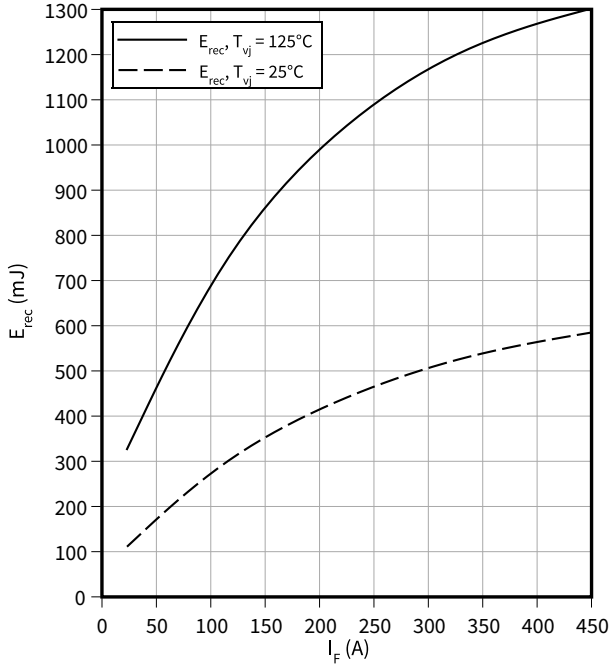

Switching losses (typical), Diode, Inverter

$E_{rec} = f(R_G)$
 $V_{CE} = 3600\text{ V}, I_F = 225\text{ A}$

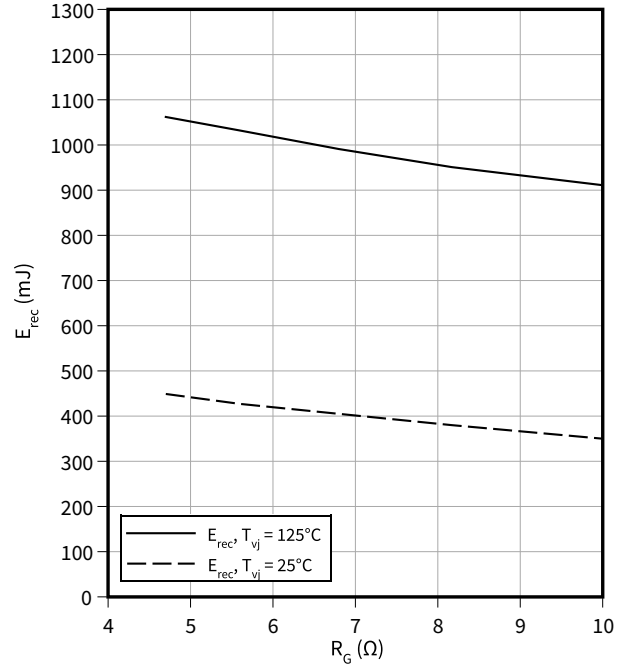

Transient thermal impedance, Diode, Inverter

$Z_{th} = f(t)$

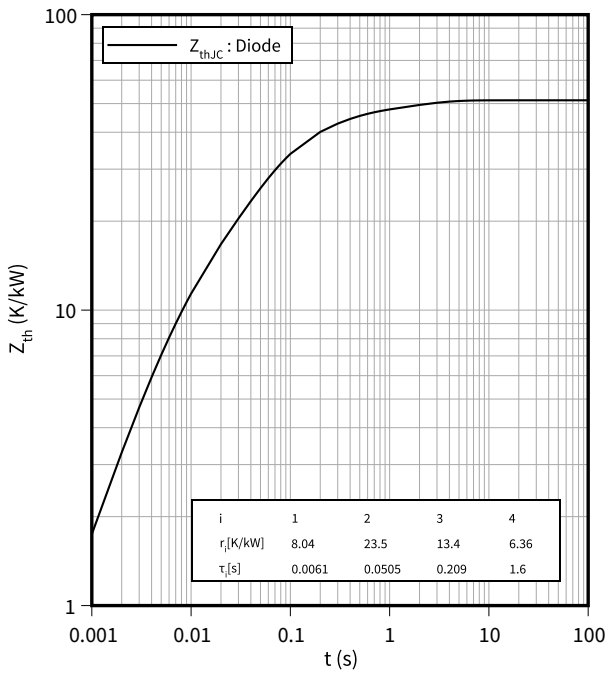

Safe operating area (SOA), Diode, Inverter

$I_R = f(V_R)$
 $T_{vj} = 125^\circ\text{C}$

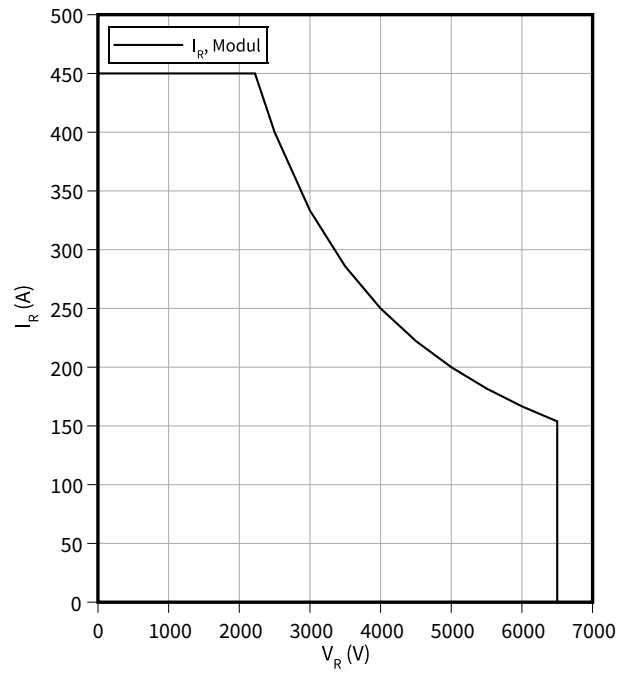

5 Circuit diagram

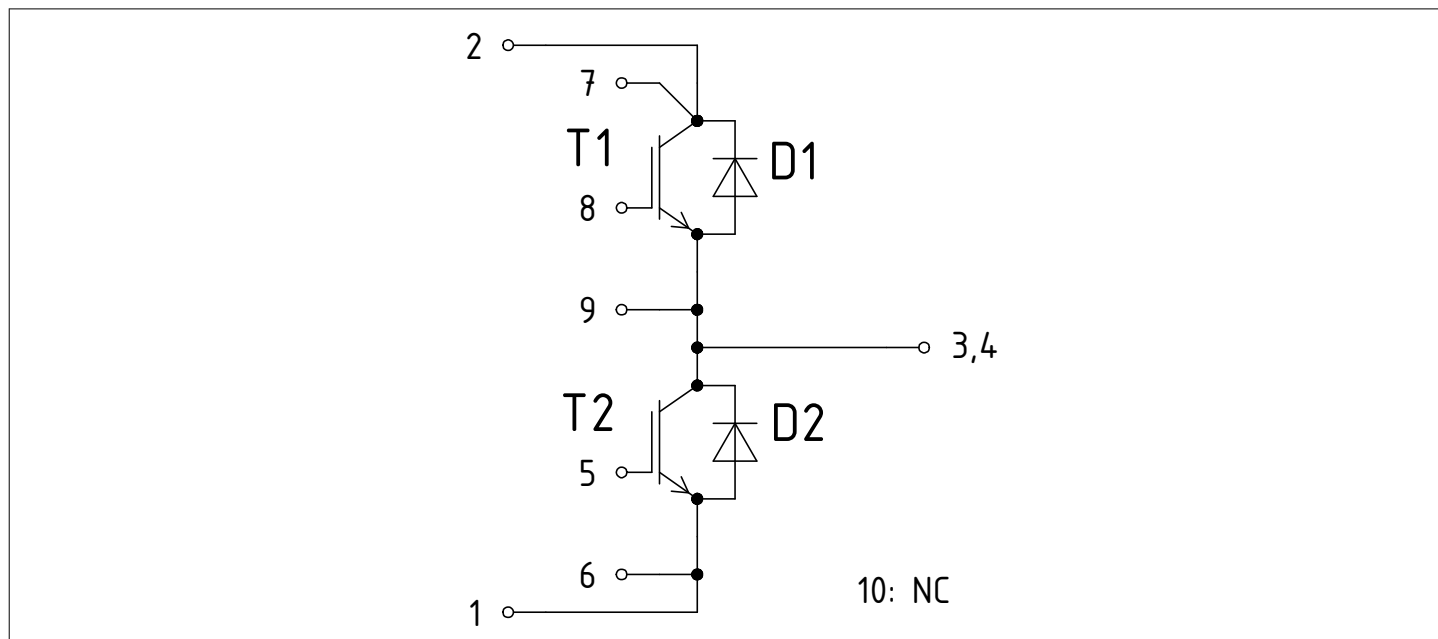

Figure 1

6 Package outlines

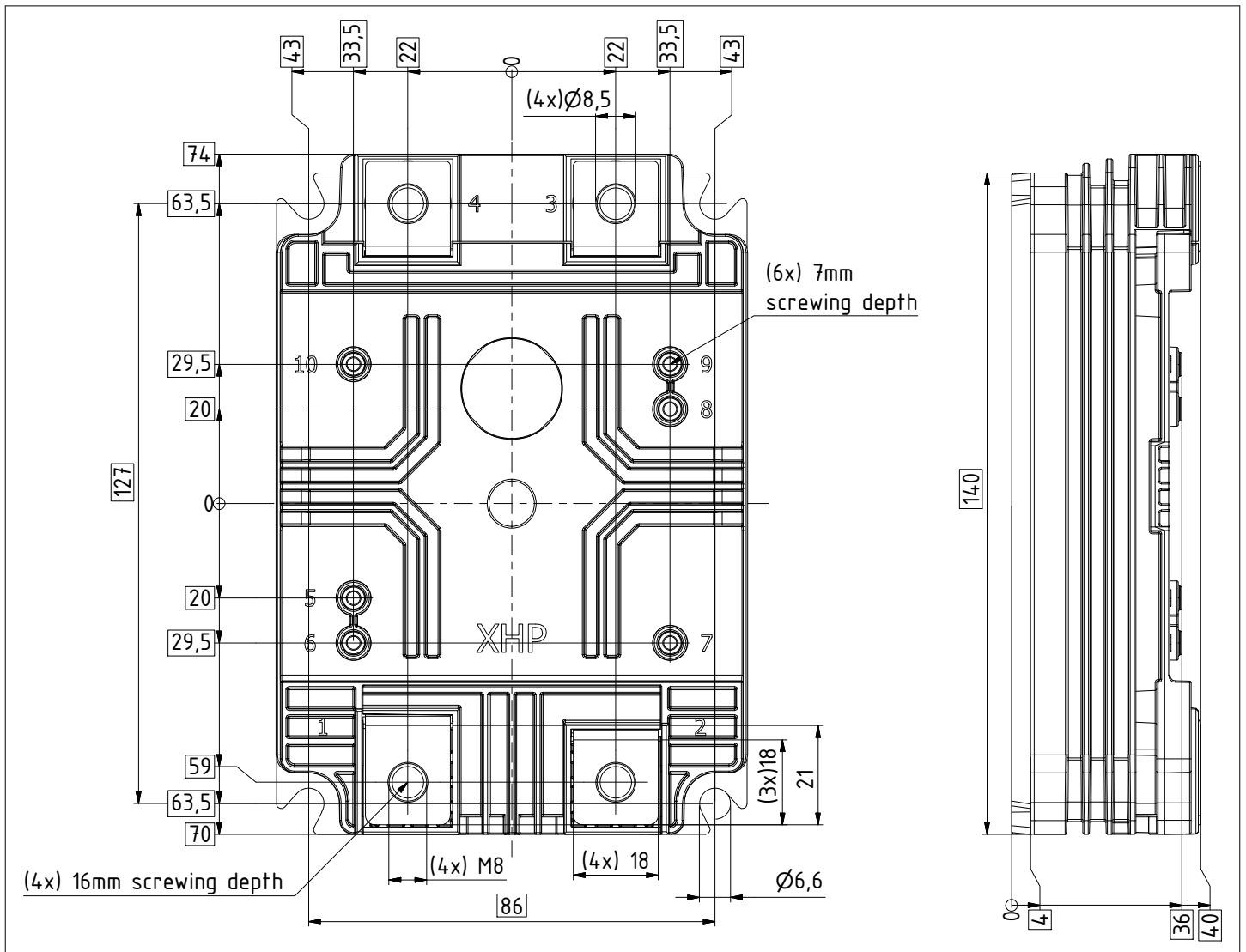

Figure 2

7 Module label code

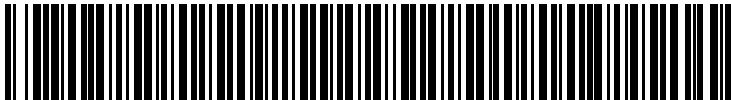
Module label code			
Code format	Data Matrix	Barcode Code128	
Encoding	ASCII text	Code Set A	
Symbol size	16x16	23 digits	
Standard	IEC24720 and IEC16022	IEC8859-1	
Code content	<i>Content</i>	<i>Digit</i>	<i>Example</i>
	Module serial number	1 - 5	71549
	Module material number	6 - 11	142846
	Production order number	12 - 19	55054991
	Date code (production year)	20 - 21	15
	Date code (production week)	22 - 23	30
Example	 		
	71549142846550549911530		71549142846550549911530

Figure 3

Revision history

Document revision	Date of release	Description of changes
V1.0	2017-12-19	Target datasheet
V1.1	2018-04-17	Target datasheet
V2.0	2018-04-23	Preliminary datasheet
n/a	2020-09-01	Datasheet migrated to a new system with a new layout and new revision number schema: target or preliminary datasheet = 0.xy; final datasheet = 1.xy
1.10	2020-12-11	
1.11	2022-04-12	Final datasheet