

XHP™3 module with Trench/Fieldstop IGBT3 and emitter controlled 3 diode

Features

- Electrical features
 - $V_{CES} = 3300\text{ V}$
 - $I_{C\text{nom}} = 450\text{ A} / I_{CRM} = 900\text{ A}$
 - Low switching losses
 - High DC stability
 - High short-circuit capability
 - Low $V_{CE,sat}$
 - $T_{vj,op} = 150^{\circ}\text{C}$
 - Unbeatable robustness
 - $V_{CE,sat}$ with positive temperature coefficient
- Mechanical features
 - ALSiC base plate for increased thermal cycling capability
 - Isolated base plate
 - Package with CTI > 600



Potential applications

- Medium-voltage converters
- Motor drives
- Traction drives
- UPS systems
- Wind turbines

Product validation

- Qualified for industrial applications according to the relevant tests of IEC 60747, 60749 and 60068

Description

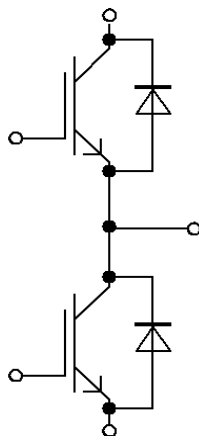

Table of contents

	Description	1
	Features	1
	Potential applications	1
	Product validation	1
	Table of contents	2
1	Package	3
2	IGBT, Inverter	3
3	Diode, Inverter	5
4	Characteristics diagrams	7
5	Circuit diagram	11
6	Package outlines	12
7	Module label code	13
	Revision history	14
	Disclaimer	15

1 Package

Table 1 Insulation coordination

Parameter	Symbol	Note or test condition	Values	Unit
Isolation test voltage	V_{ISOL}	RMS, $f = 50 \text{ Hz}$, $t = 10 \text{ s}$	6.0	kV
Partial discharge extinction voltage	V_{isol}	RMS, $f = 50 \text{ Hz}$, $Q_{PD} \leq 10 \text{ pC}$	2.6	kV
Material of module baseplate			AlSiC	
Creepage distance	d_{Creep}	terminal to heatsink	53.0	mm
Creepage distance	d_{Creep}	terminal to terminal	53.0	mm
Clearance	d_{Clear}	terminal to heatsink	26.0	mm
Clearance	d_{Clear}	terminal to terminal	26.0	mm
Comparative tracking index	CTI		>600	

Table 2 Characteristic values

Parameter	Symbol	Note or test condition	Values			Unit	
			Min.	Typ.	Max.		
Stray inductance module	L_{SCE}			25		nH	
Module lead resistance, terminals - chip	$R_{AA'+CC'}$	$T_C = 25^\circ\text{C}$, per switch		0.31		mΩ	
Module lead resistance, terminals - chip	$R_{CC'+EE'}$	$T_C = 25^\circ\text{C}$, per switch		0.41		mΩ	
Storage temperature	T_{stg}		-40		150	°C	
Mounting torque for module mounting	M	- Mounting according to valid application note	M6, Screw	4.25		5.75	Nm
Terminal connection torque	M	- Mounting according to valid application note	M3, Screw	0.9		1.1	Nm
			M8, Screw	8		10	
Weight	G			700		g	

2 IGBT, Inverter

Table 3 Maximum rated values

Parameter	Symbol	Note or test condition	Values	Unit	
Collector-emitter voltage	V_{CES}		$T_{vj} = -40^\circ\text{C}$	3300	V
			$T_{vj} = 150^\circ\text{C}$	3300	
Continuous DC collector current	I_{CDC}	$T_{vj \text{ max}} = 150^\circ\text{C}$	$T_C = 100^\circ\text{C}$	450	A
Repetitive peak collector current	I_{CRM}	$t_p = 1 \text{ ms}$		900	A

(table continues...)

Table 3 (continued) Maximum rated values

Parameter	Symbol	Note or test condition	Values	Unit
Gate-emitter peak voltage	V_{GES}		±20	V

Table 4 Characteristic values

Parameter	Symbol	Note or test condition	Values			Unit
			Min.	Typ.	Max.	
Collector-emitter saturation voltage	$V_{CE\ sat}$	$I_C = 450\ A, V_{GE} = 15\ V$	$T_{vj} = 25\ ^\circ C$	2.50	2.75	V
			$T_{vj} = 125\ ^\circ C$	2.90		
			$T_{vj} = 150\ ^\circ C$	3.00	3.30	
Gate threshold voltage	V_{GEth}	$I_C = 12\ mA, V_{CE} = V_{GE}, T_{vj} = 25\ ^\circ C$	5.20	5.80	6.40	V
Gate charge	Q_G	$V_{GE} = \pm 15\ V, V_{CE} = 1800\ V$		12.5		μC
Internal gate resistor	R_{Gint}	$T_{vj} = 25\ ^\circ C$		1.3		Ω
Input capacitance	C_{ies}	$f = 1000\ kHz, T_{vj} = 25\ ^\circ C, V_{CE} = 25\ V, V_{GE} = 0\ V$		84		nF
Reverse transfer capacitance	C_{res}	$f = 1000\ kHz, T_{vj} = 25\ ^\circ C, V_{CE} = 25\ V, V_{GE} = 0\ V$		2		nF
Collector-emitter cut-off current	I_{CES}	$V_{CE} = 3300\ V, V_{GE} = 0\ V$			5	mA
Gate-emitter leakage current	I_{GES}	$V_{CE} = 0\ V, V_{GE} = 20\ V, T_{vj} = 25\ ^\circ C$			400	nA
Turn-on delay time (inductive load)	t_{don}	$I_C = 450\ A, V_{CE} = 1800\ V, V_{GE} = \pm 15\ V, R_{Gon} = 0.7\ \Omega$	$T_{vj} = 25\ ^\circ C$	0.530		μs
			$T_{vj} = 125\ ^\circ C$	0.570		
			$T_{vj} = 150\ ^\circ C$	0.580		
Rise time (inductive load)	t_r	$I_C = 450\ A, V_{CE} = 1800\ V, V_{GE} = \pm 15\ V, R_{Gon} = 0.7\ \Omega$	$T_{vj} = 25\ ^\circ C$	0.100		μs
			$T_{vj} = 125\ ^\circ C$	0.130		
			$T_{vj} = 150\ ^\circ C$	0.130		
Turn-off delay time (inductive load)	t_{doff}	$I_C = 450\ A, V_{CE} = 1800\ V, V_{GE} = \pm 15\ V, R_{Goff} = 3.3\ \Omega$	$T_{vj} = 25\ ^\circ C$	1.710		μs
			$T_{vj} = 125\ ^\circ C$	1.860		
			$T_{vj} = 150\ ^\circ C$	1.920		
Fall time (inductive load)	t_f	$I_C = 450\ A, V_{CE} = 1800\ V, V_{GE} = \pm 15\ V, R_{Goff} = 3.3\ \Omega$	$T_{vj} = 25\ ^\circ C$	0.130		μs
			$T_{vj} = 125\ ^\circ C$	0.240		
			$T_{vj} = 150\ ^\circ C$	0.270		
Turn-on time (resistive load)	t_{on_R}	$I_C = 500\ A, V_{CE} = 2000\ V, V_{GE} = \pm 15\ V, R_{Gon} = 0.7\ \Omega$	$T_{vj} = 25\ ^\circ C$	1.15		μs
Turn-on energy loss per pulse	E_{on}	$I_C = 450\ A, V_{CE} = 1800\ V, L_\sigma = 85\ nH, V_{GE} = \pm 15\ V, R_{Gon} = 0.7\ \Omega, di/dt = 3650\ A/\mu s (T_{vj} = 150\ ^\circ C)$	$T_{vj} = 25\ ^\circ C$	500		mJ
			$T_{vj} = 125\ ^\circ C$	765		
			$T_{vj} = 150\ ^\circ C$	845		

(table continues...)

Table 4 (continued) Characteristic values

Parameter	Symbol	Note or test condition	Values			Unit
			Min.	Typ.	Max.	
Turn-off energy loss per pulse	E_{off}	$I_C = 450\text{ A}$, $V_{CE} = 1800\text{ V}$, $L_\sigma = 85\text{ nH}$, $V_{GE} = \pm 15\text{ V}$, $R_{Goff} = 3.3\ \Omega$, $dv/dt = 2850\text{ V}/\mu\text{s}$ ($T_{vj} = 150\text{ }^\circ\text{C}$)	$T_{vj} = 25\text{ }^\circ\text{C}$	415		mJ
			$T_{vj} = 125\text{ }^\circ\text{C}$	610		
			$T_{vj} = 150\text{ }^\circ\text{C}$	670		
SC data	I_{SC}	$V_{GE} \leq 15\text{ V}$, $V_{CC} = 2500\text{ V}$, $V_{CEmax} = V_{CES} - L_{sCE} \cdot di/dt$	$t_p \leq 10\ \mu\text{s}$, $T_{vj} \leq 150\text{ }^\circ\text{C}$	1800		A
Thermal resistance, junction to case	R_{thJC}	per IGBT			28.4	K/kW
Thermal resistance, case to heat sink	R_{thCH}	per IGBT, $\lambda_{grease} = 1\text{ W}/(\text{m}^2\text{K})$		17.4		K/kW
Temperature under switching conditions	$T_{vj\text{op}}$		-40		150	$^\circ\text{C}$

3 Diode, Inverter

Table 5 Maximum rated values

Parameter	Symbol	Note or test condition	Values	Unit	
Repetitive peak reverse voltage	V_{RRM}		$T_{vj} = -40\text{ }^\circ\text{C}$	3300	V
			$T_{vj} = 150\text{ }^\circ\text{C}$	3300	
Continuous DC forward current	I_F		450	A	
Repetitive peak forward current	I_{FRM}	$t_p = 1\text{ ms}$	900	A	
I^2t - value	I^2t	$t_p = 10\text{ ms}$, $V_R = 0\text{ V}$	$T_{vj} = 125\text{ }^\circ\text{C}$	82.9	kA ² s
			$T_{vj} = 150\text{ }^\circ\text{C}$	68	
Maximum power dissipation	P_{RQM}	$T_{vj} = 150\text{ }^\circ\text{C}$	1000	kW	
Minimum turn-on time	t_{onmin}		10	μs	

Table 6 Characteristic values

Parameter	Symbol	Note or test condition	Values			Unit
			Min.	Typ.	Max.	
Forward voltage	V_F	$I_F = 450\text{ A}$, $V_{GE} = 0\text{ V}$	$T_{vj} = 25\text{ }^\circ\text{C}$	3.10	3.50	V
			$T_{vj} = 125\text{ }^\circ\text{C}$	2.75		
			$T_{vj} = 150\text{ }^\circ\text{C}$	2.65	2.95	

(table continues...)

Table 6 (continued) Characteristic values

Parameter	Symbol	Note or test condition	Values			Unit
			Min.	Typ.	Max.	
Peak reverse recovery current	I_{RM}	$V_R = 1800\text{ V}$, $I_F = 450\text{ A}$, $V_{GE} = -15\text{ V}$, $-di_F/dt = 3650\text{ A}/\mu\text{s}$ ($T_{vj} = 150\text{ °C}$)	$T_{vj} = 25\text{ °C}$	680		A
			$T_{vj} = 125\text{ °C}$	680		
			$T_{vj} = 150\text{ °C}$	680		
Recovered charge	Q_r	$V_R = 1800\text{ V}$, $I_F = 450\text{ A}$, $V_{GE} = -15\text{ V}$, $-di_F/dt = 3650\text{ A}/\mu\text{s}$ ($T_{vj} = 150\text{ °C}$)	$T_{vj} = 25\text{ °C}$	230		μC
			$T_{vj} = 125\text{ °C}$	445		
			$T_{vj} = 150\text{ °C}$	525		
Reverse recovery energy	E_{rec}	$V_R = 1800\text{ V}$, $I_F = 450\text{ A}$, $V_{GE} = -15\text{ V}$, $-di_F/dt = 3650\text{ A}/\mu\text{s}$ ($T_{vj} = 150\text{ °C}$)	$T_{vj} = 25\text{ °C}$	220		mJ
			$T_{vj} = 125\text{ °C}$	490		
			$T_{vj} = 150\text{ °C}$	595		
Thermal resistance, junction to case	R_{thJC}	per diode			45.5	K/kW
Thermal resistance, case to heat sink	R_{thCH}	per diode, $\lambda_{grease} = 1\text{ W}/(\text{m}^*\text{K})$		19.3		K/kW
Temperature under switching conditions	$T_{vj\text{ op}}$		-40		150	$^{\circ}\text{C}$

4 Characteristics diagrams

output characteristic (typical), IGBT, Inverter

$I_C = f(V_{CE})$
 $V_{GE} = 15\text{ V}$

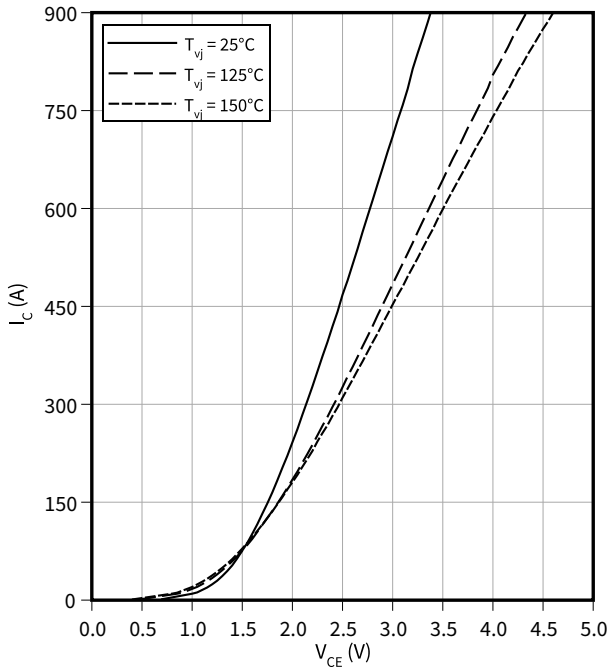

output characteristic (typical), IGBT, Inverter

$I_C = f(V_{CE})$
 $T_{vj} = 150\text{ °C}$

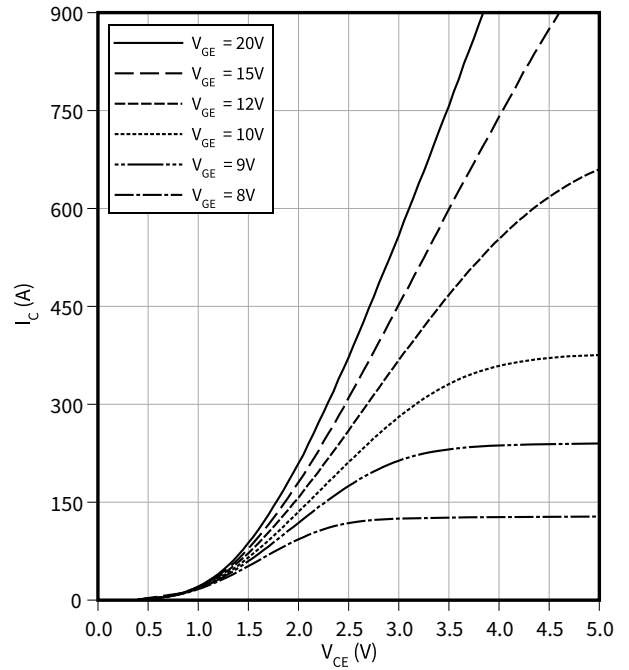

transfer characteristic (typical), IGBT, Inverter

$I_C = f(V_{GE})$
 $V_{CE} = 20\text{ V}$

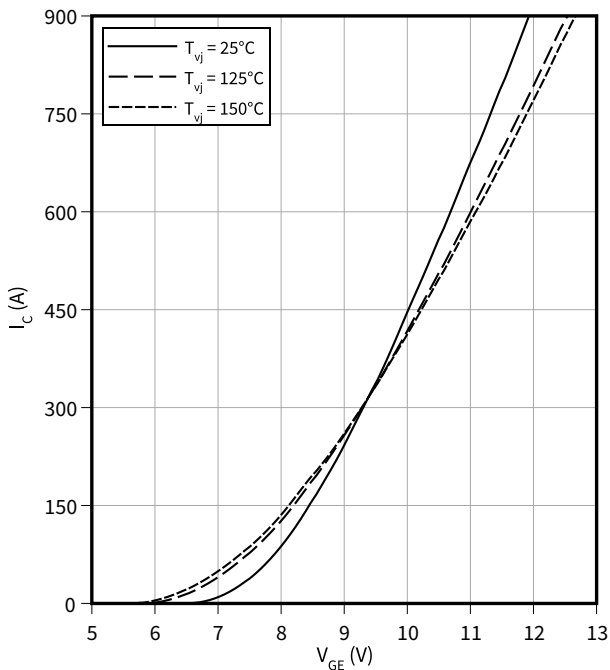

switching losses (typical), IGBT, Inverter

$E = f(I_C)$
 $R_{Goff} = 3.3\ \Omega$, $R_{Gon} = 0.7\ \Omega$, $V_{CE} = 1800\text{ V}$, $V_{GE} = \pm 15\text{ V}$

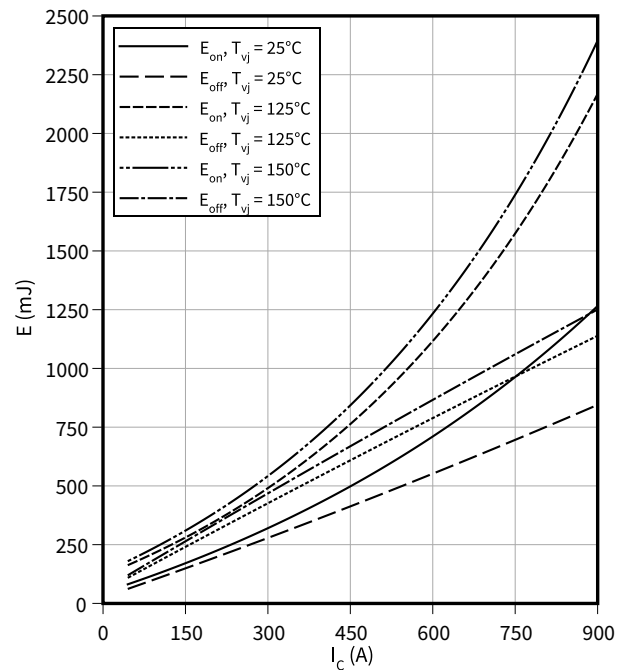

4 Characteristics diagrams

switching losses (typical), IGBT, Inverter

$E = f(R_G)$

$I_C = 450 \text{ A}, V_{CE} = 1800 \text{ V}, V_{GE} = \pm 15 \text{ V}$

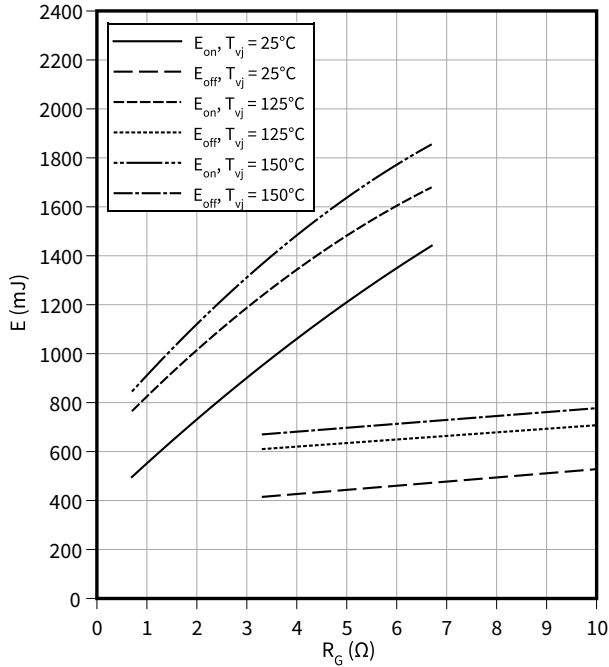

switching times (typical), IGBT, Inverter

$t = f(I_C)$

$R_{Goff} = 3.3 \Omega, R_{Gon} = 0.7 \Omega, V_{CE} = 1800 \text{ V}, V_{GE} = \pm 15 \text{ V}, T_{vj} = 150^\circ\text{C}$

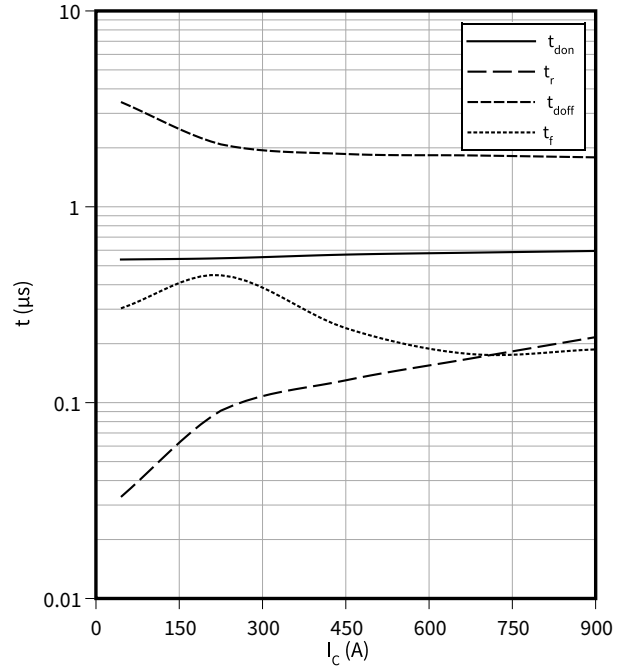

switching times (typical), IGBT, Inverter

$t = f(R_G)$

$I_C = 450 \text{ A}, V_{CE} = 1800 \text{ V}, V_{GE} = \pm 15 \text{ V}, T_{vj} = 150^\circ\text{C}$

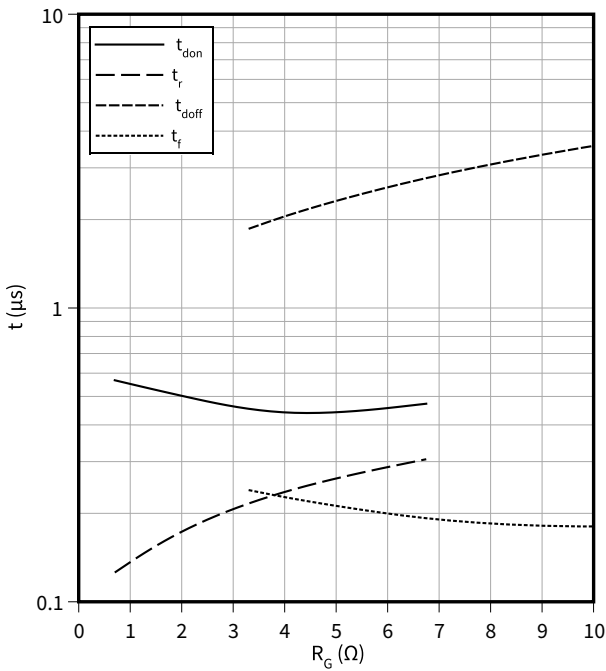

transient thermal impedance, IGBT, Inverter

$Z_{th} = f(t)$

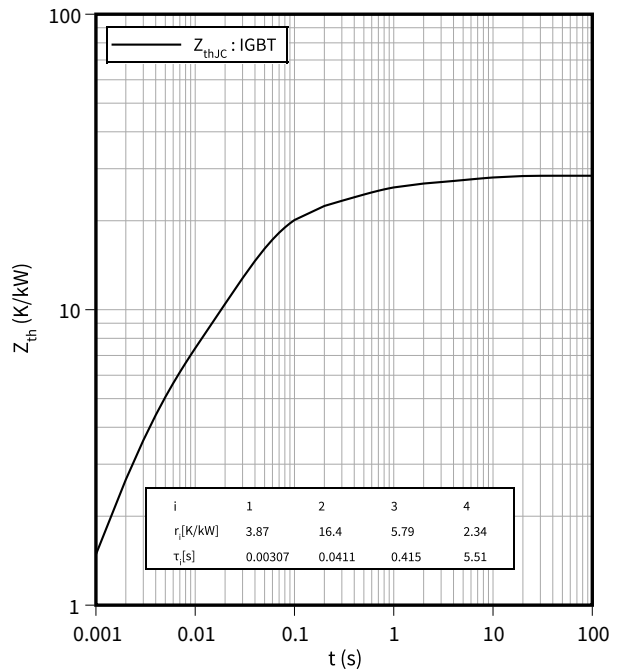

4 Characteristics diagrams

reverse bias safe operating area (RBSOA), IGBT, Inverter

$I_C = f(V_{CE})$

$R_{Goff} = 3.3 \Omega, V_{GE} = \pm 15 V, T_{vj} = 150 \text{ }^\circ\text{C}$

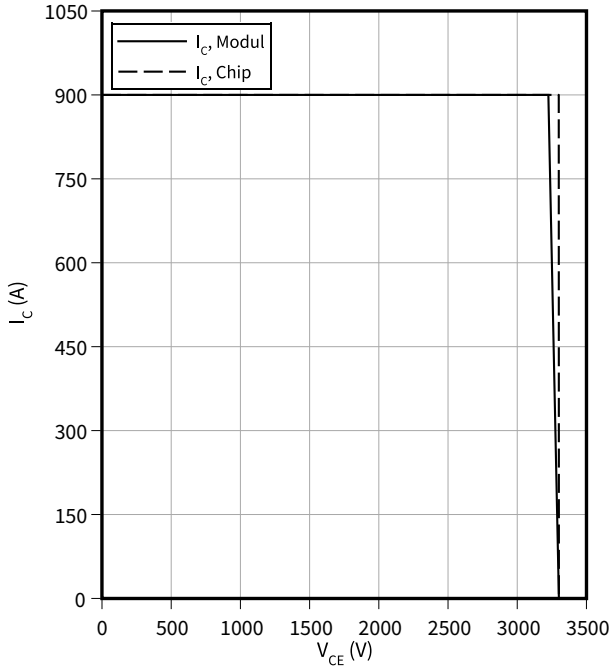

capacity characteristic (typical), IGBT, Inverter

$C = f(V_{CE})$

$f = 1000 \text{ kHz}, V_{GE} = 0 V, T_{vj} = 25 \text{ }^\circ\text{C}$

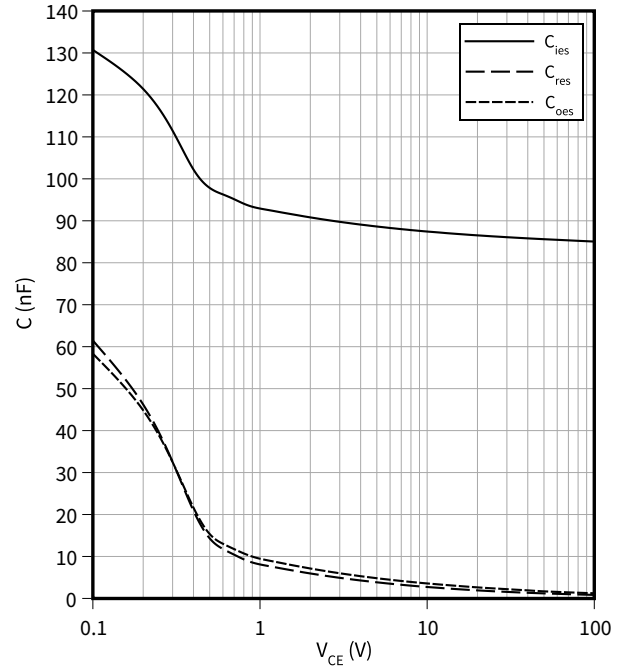

gate charge characteristic (typical), IGBT, Inverter

$V_{GE} = f(Q_G)$

$I_C = 450 A, T_{vj} = 25 \text{ }^\circ\text{C}$

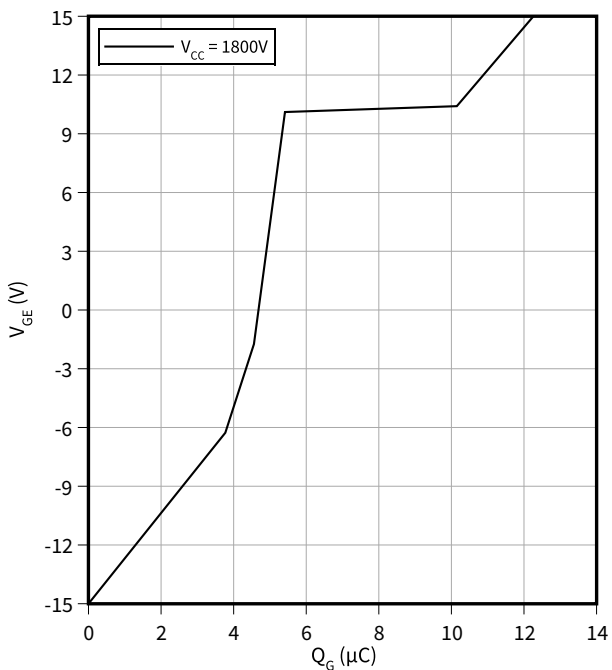

forward characteristic of (typical), Diode, Inverter

$I_F = f(V_F)$

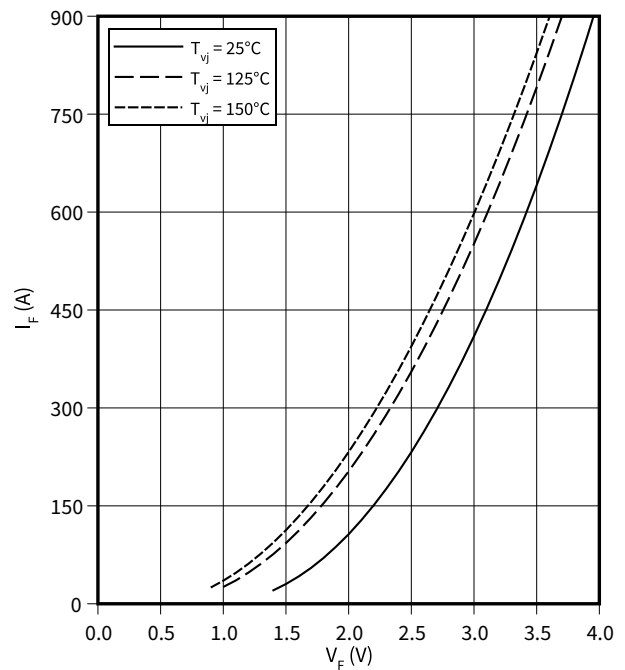

4 Characteristics diagrams

switching losses (typical), Diode, Inverter

$E_{rec} = f(I_F)$

$V_{CE} = 1800\text{ V}, R_{Gon} = R_{Gon}(IGBT)$

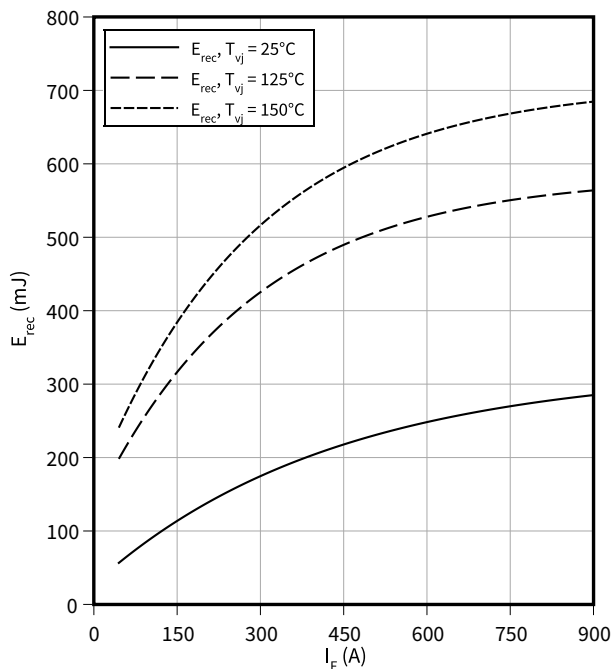

switching losses (typical), Diode, Inverter

$E_{rec} = f(R_G)$

$V_{CE} = 1800\text{ V}, I_F = 450\text{ A}$

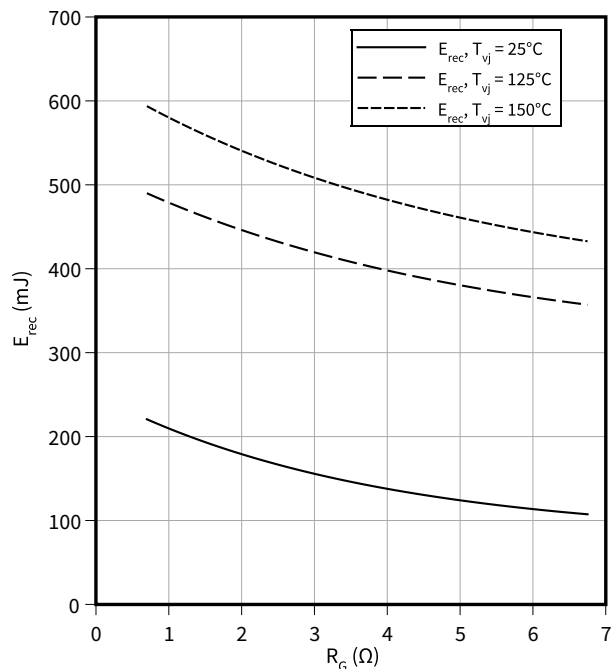

transient thermal impedance , Diode, Inverter

$Z_{th} = f(t)$

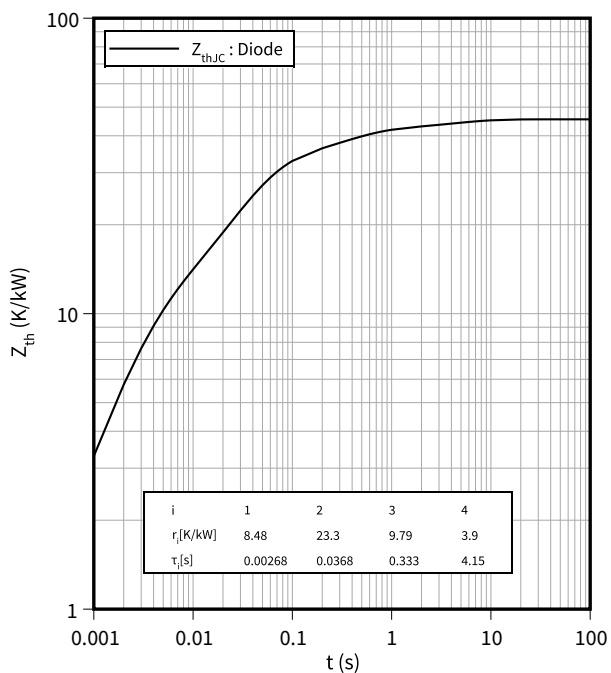

safe operation area (SOA), Diode, Inverter

$I_R = f(V_R)$

$T_{vj} = 150\text{ °C}$

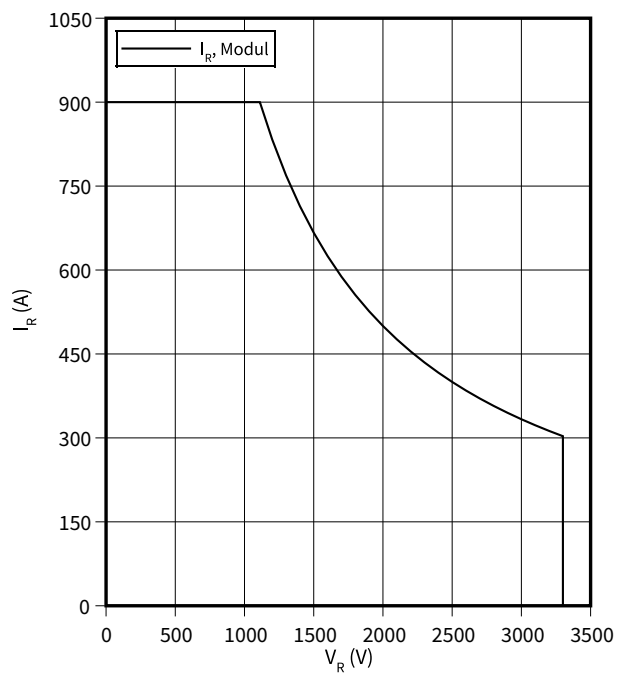

5 Circuit diagram

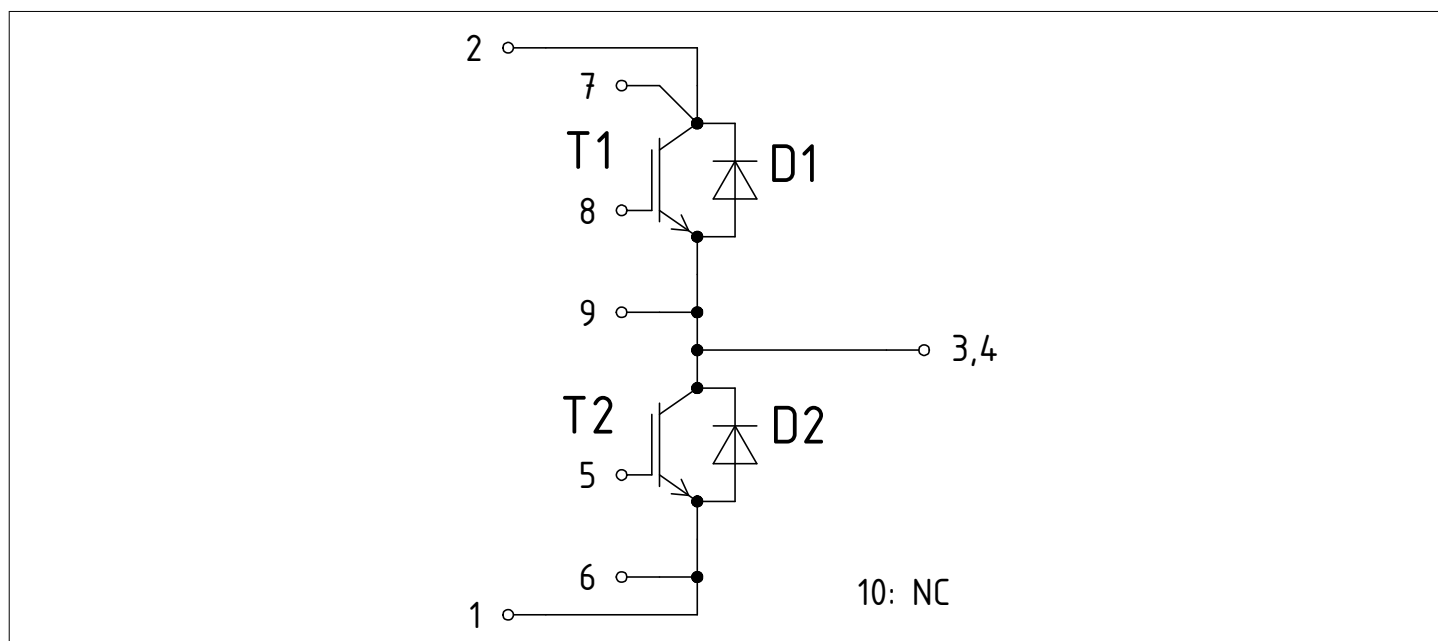

Figure 1

6 Package outlines

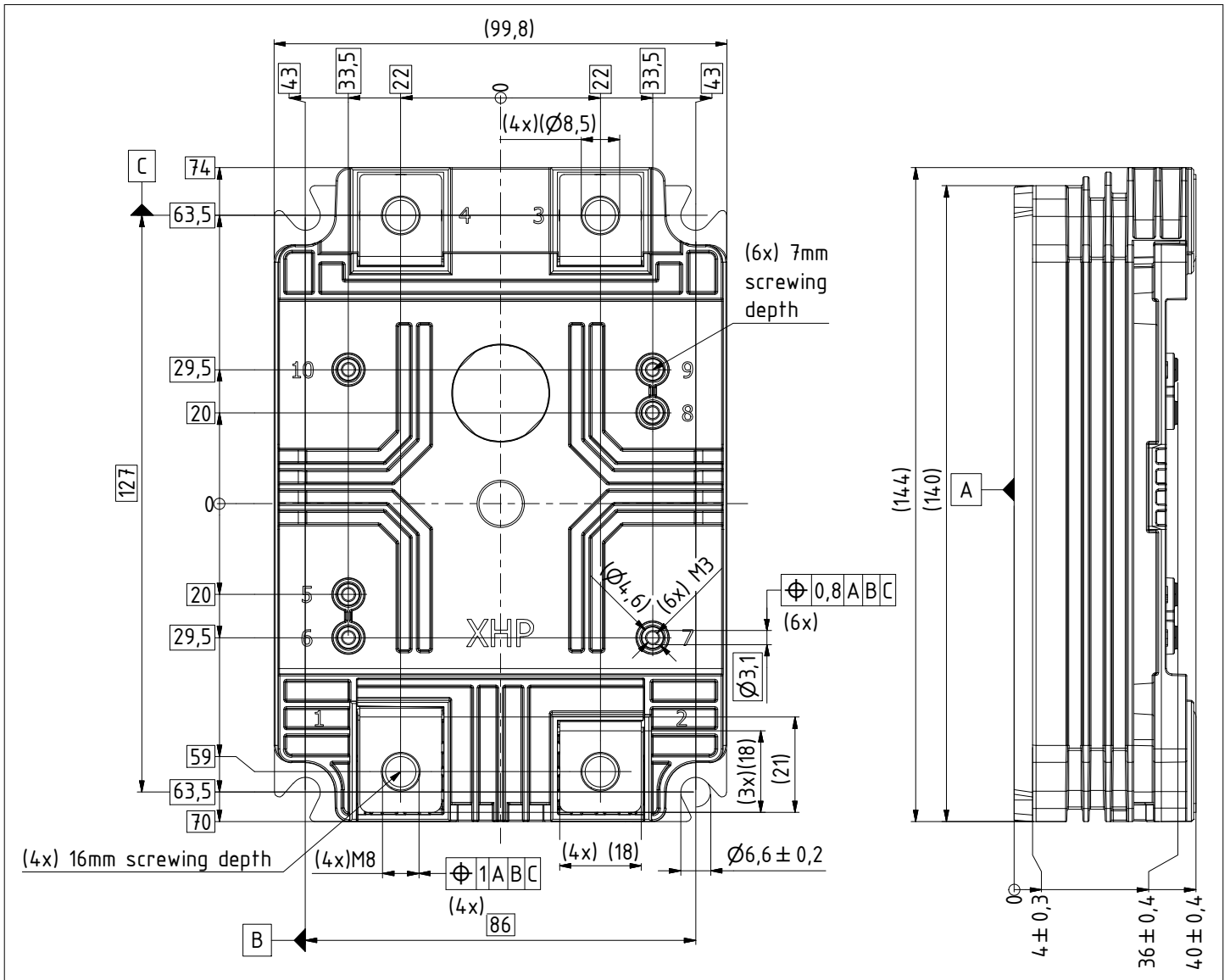

Figure 2

7 Module label code



Module label code			
Code format	Data Matrix	Barcode Code128	
Encoding	ASCII text	Code Set A	
Symbol size	16x16	23 digits	
Standard	IEC24720 and IEC16022	IEC8859-1	
Code content	Content	Digit	Example
	Module serial number	1 - 5	71549
	Module material number	6 - 11	142846
	Production order number	12 - 19	55054991
	Date code (production year)	20 - 21	15
	Date code (production week)	22 - 23	30
Example	 		
	71549142846550549911530		71549142846550549911530

Figure 3

Revision history

Document revision	Date of release	Description of changes
V1.0	2013-12-05	Target datasheet
V1.1	2014-08-25	Target datasheet
V1.2	2015-01-22	Target datasheet
V1.3	2015-10-16	Target datasheet
V1.4	2015-10-16	Target datasheet
V2.0	2016-05-18	Preliminary datasheet
V2.1	2016-09-02	Preliminary datasheet
V2.2	2016-12-23	Preliminary datasheet
V2.3	2018-02-14	Preliminary datasheet
V3.0	2018-12-12	Final datasheet
V3.1	2018-12-13	Final datasheet
V3.2	2020-01-27	Final datasheet
n/a	2020-09-01	Datasheet migrated to a new system with a new layout and new revision number schema: target or preliminary datasheet = 0.xy; final datasheet = 1.xy
1.10	2021-11-04	Final datasheet