

**SURFACE MOUNT GLASS PASSIVATED
FAST RECOVERY SILICON RECTIFIER**
VOLTAGE RANGE 50 to 1000 Volts CURRENT 3.0 Amperes

FEATURES

- * Glass passivated device
- * Ideal for surface mounted applications
- * Low leakage current
- * Metallurgically bonded construction
- * P/N suffix V means AEC-Q101 qualified
- * P/N suffix V means Halogen-free

MECHANICAL DATA

- * Epoxy : Device has UL flammability classification 94V-0
- * Mounting position: Any
- * Weight: 0.24 gram

MAXIMUM RATINGS AND ELECTRICAL CHARACTERISTICS

Ratings at 25 °C ambient temperature unless otherwise specified.
Single phase, half wave, 60 Hz, resistive or inductive load.
For capacitive load, derate current by 20%.



DO-214AB

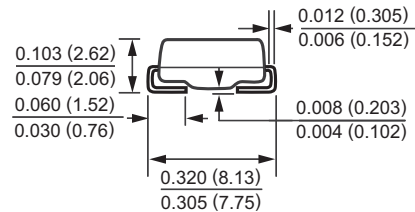
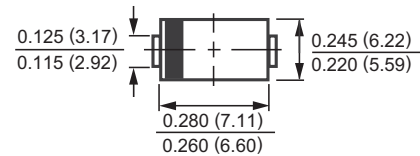

Dimensions in inches and (millimeters)

MAXIMUM RATINGS (At TA = 25°C unless otherwise noted)

RATINGS	SYMBOL	FFM301	FFM302	FFM303	FFM304	FFM305	FFM306	FFM307	UNITS
Maximum Recurrent Peak Reverse Voltage	VRRM	50	100	200	400	600	800	1000	Volts
Maximum RMS Voltage	VRMS	35	70	140	280	420	560	700	Volts
Maximum DC Blocking Voltage	Vdc	50	100	200	400	600	800	1000	Volts
Maximum Average Forward Rectified Current at TA = 55°C	Io	3.0							Amps
Peak Forward Surge Current 8.3 ms single half sine-wave superimposed on rated load (JEDEC method)	IFSM	200							Amps
Typical Current Squared Time	i ² t	166							A ² /Sec
Maximum Thermal Resistance	(Note 2) RθJL	15							°C/W
	(Note 3) RθJA	50							°C/W
Typical Junction Capacitance (Note 1)	CJ	60							pF
Operating and Storage Temperature Range	TJ, TSTG	-65 to + 175							°C

ELECTRICAL CHARACTERISTICS (At TA = 25°C unless otherwise noted)

CHARACTERISTICS	SYMBOL	FFM301	FFM302	FFM303	FFM304	FFM305	FFM306	FFM307	UNITS
Maximum Forward Voltage at 3.0A DC	VF	1.3							Volts
Maximum Full Load Reverse Current, Full cycle Average at TA=55°C	IR	50							uAmps
Maximum DC Reverse Current at @TA = 25°C		10							uAmps
Rated DC Blocking Voltage @TA = 150°C		5.0							mAmps
Maximum Reverse Recovery Time (Note 4)	trr	150			250		500		nSec

- NOTES : 1. Measured at 1.0 MHz and applied average voltage of 4.0VDC
 2. Thermal resistance junction to terminal 6.0mm² copper pads to each terminal.
 3. Thermal resistance junction to ambient, 6.0mm² copper pads to each terminal.
 4. Test Conditions: IF = 0.5A, IR = -1.0A, IRR = -0.25A

RATING AND CHARACTERISTIC CURVES (FFM301 THRU FFM307)

FIG. 1 - TYPICAL FORWARD CURRENT DERATING CURVE

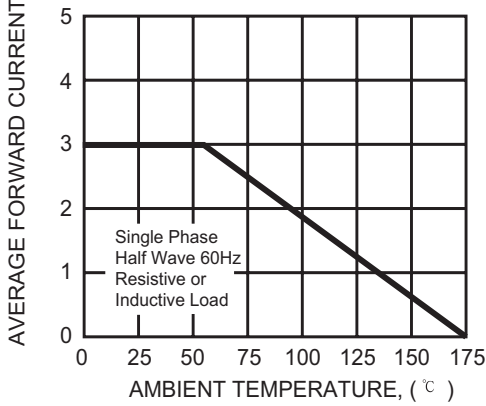

FIG. 2 - MAXIMUM NON-REPETITIVE FORWARD SURGE CURRENT

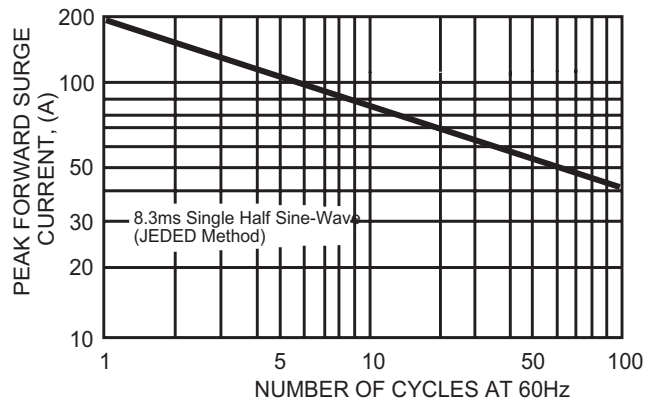

FIG. 3 - TYPICAL INSTANTANEOUS FORWARD CHARACTERISTICS

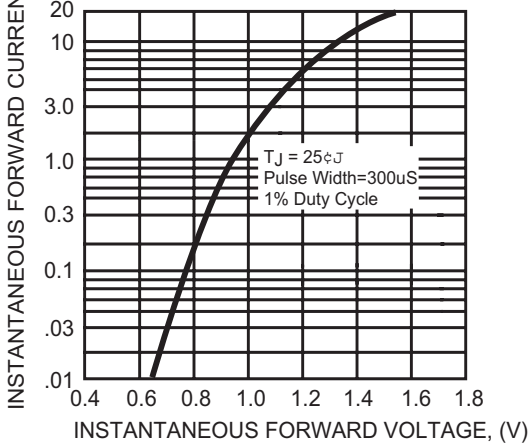

FIG. 4 - TYPICAL JUNCTION CAPACITANCE

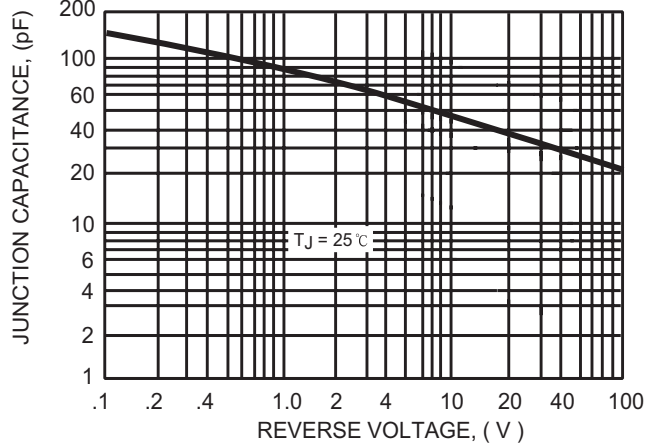
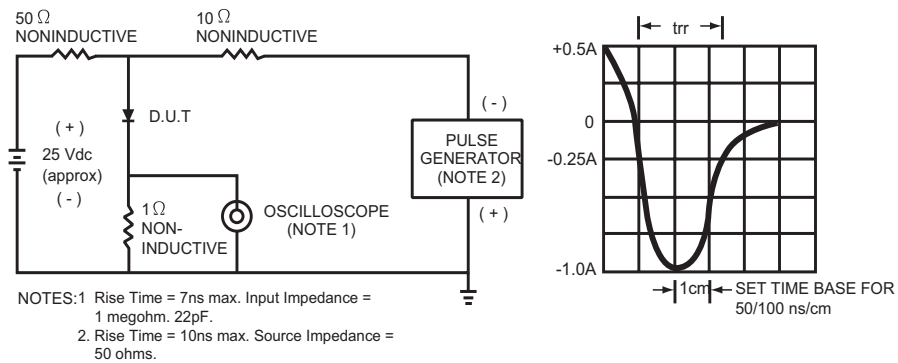
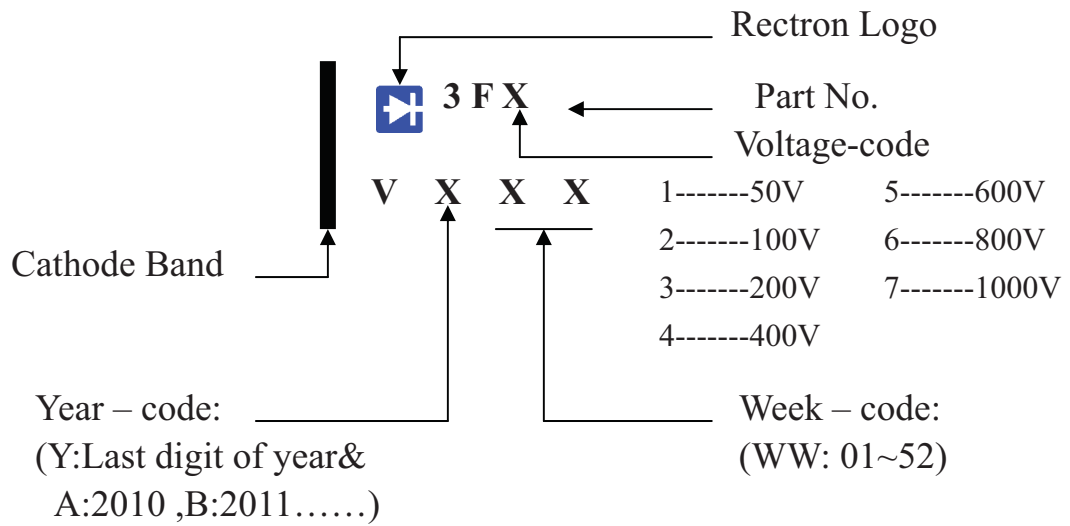

FIG. 5 - TEST CIRCUIT DIAGRAM AND REVERSE RECOVERY TIME CHARACTERISTIC



Marking Description



PACKAGING OF DIODE AND BRIDGE RECTIFIERS

REEL PACK

PACKAGE	PACKING CODE	EA PER REEL	EA PER INNER BOX	COMPONENT SPACE (mm)	TAPE SPACE (mm)	REEL DIA (mm)	CARTON SIZE (mm)	EA PER CARTON	GROSS WEIGHT(Kg)
SMC	-T	500	1,500	---	---	178	390*205*310	12,000	6.65
SMC	-W	3,000	3,000	---	---	330	360*355*360	24,000	11.50