

SURFACE MOUNT SCHOTTKY BARRIER RECTIFIER

VOLTAGE RANG 20 to 100 Volts CURRENT 2.0 Ampere

FEATURES

- * Low switching noise
- * Low forward voltage drop
- * High current capability
- * High speed switching
- * High surge capability
- * High reliability

MECHANICAL DATA

- * Case: Molded plastic
- * Epoxy: Device has UL flammability classification 94V-0
- * Lead: MIL-STD-202E method 208C guaranteed
- * Mounting position: Any
- * Weight: 0.09gram

MAXIMUM RATINGS AND ELECTRICAL CHARACTERISTICS

Ratings at 25 °C ambient temperature unless otherwise specified.
Single phase, half wave, 60 Hz, resistive or inductive load.
For capacitive load, derate current by 20%.

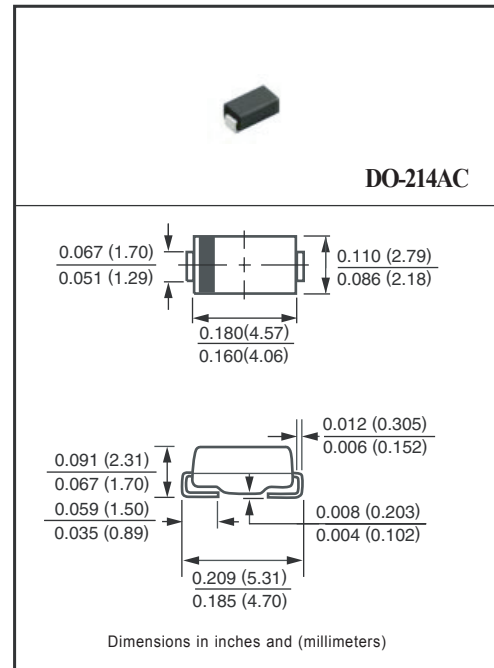

MAXIMUM RATINGS (@ TA=25 °C unless otherwise noted)

| RATINGS | SYMBOL | FM220A | FM230A | FM240A | FM250A | FM260A | FM280A | FM290A | FM2100A | UNITS |
|---|------------------|--------------|--------|--------|--------|--------|--------|--------|---------|-------|
| Maximum Recurrent Peak Reverse Voltage | V _{RRM} | 20 | 30 | 40 | 50 | 60 | 80 | 90 | 100 | Volts |
| Maximum RMS Voltage | V _{RMS} | 14 | 21 | 28 | 35 | 42 | 56 | 63 | 70 | Volts |
| Maximum DC Blocking Voltage | V _{DC} | 20 | 30 | 40 | 50 | 60 | 80 | 90 | 100 | Volts |
| Maximum Average Forward Rectified Current @ T _T =120°C | I _O | 2.0 | | | | | | | | Amps |
| Peak Forward Surge Current 8.3 ms single half sine-wave superimposed on rated load (JEDEC method) | I _{FSM} | 60 | | | | | | | | Amps |
| Thermal Resistance Junction to Ambient | R _{θJA} | 40 | | | | | | | | °C/W |
| Total Capacitance | C _J | 130 | | | | | | | | pF |
| Operating Temperature Range | T _J | -55 to + 125 | | | | | | | | °C |
| Storage Temperature Range | T _{STG} | -55 to + 150 | | | | | | | | °C |

ELECTRICAL CHARACTERISTICS (@TA=25 °C unless otherwise noted)

| CHARACTERISTICS | SYMBOL | FM220A | FM230A | FM240A | FM250A | FM260A | FM280A | FM290A | FM2100A | UNITS |
|--|----------------|--------|--------|--------|--------|--------|--------|--------|---------|-------|
| Maximum Instantaneous Forward Voltage at 2.0A DC | V _F | 0.55 | | | 0.70 | | 0.85 | | | Volts |
| Maximum Average Reverse Current | I _R | 0.2 | | | | | | | | mAmps |
| at Rated DC Blocking Voltage | | 2.0 | | | | | | | | mAmps |

NOTES : 1. Measured at 1 MHz and applied reverse voltage of 10 volts.
2. "Fully ROHS compliant", "100% Sn plating (Pb-free)".

RATING AND CHARACTERISTICS CURVES (FM220A THRU FM2100A)

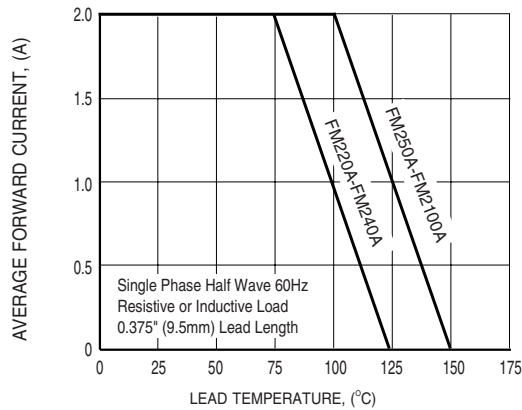

FIG.1 TYPICAL FORWARD CURRENT DERATING CURVE

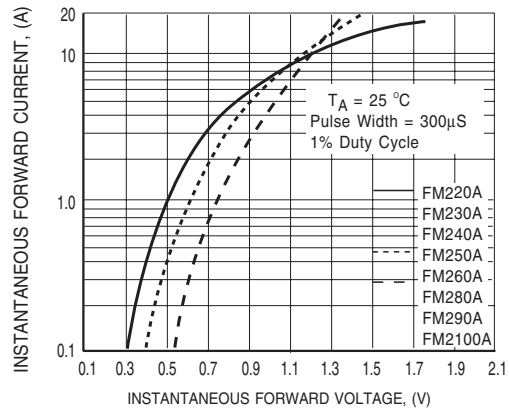

FIG.2 TYPICAL INSTANTANEOUS FORWARD CHARACTERISTICS

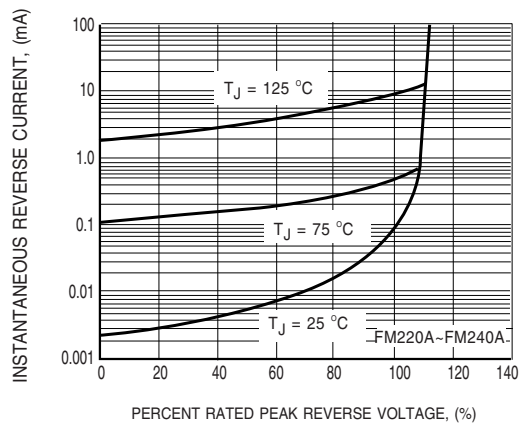

FIG.3 TYPICAL REVERSE CHARACTERISTICS

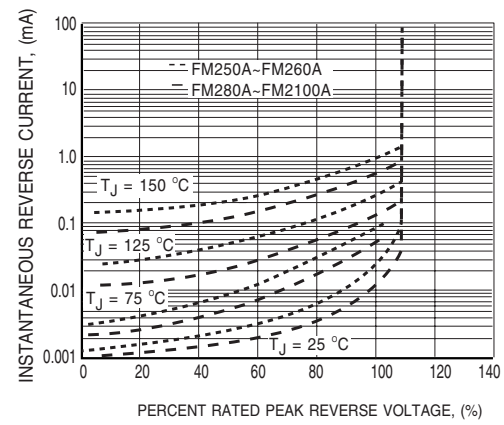

FIG.4 TYPICAL REVERSE CHARACTERISTICS

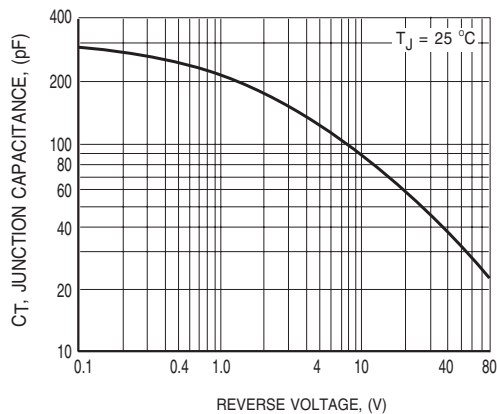

FIG.5 TYPICAL JUNCTION CAPACITANCE

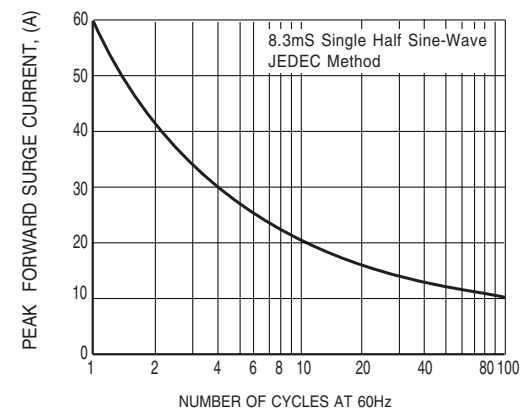

FIG.6 MAXIMUM NON-REPETITIVE FORWARD SURGE CURRENT