

Overview

FM Series Supercapacitors, also known as Electric Double-Layer Capacitors (EDLCs), are intended for high energy storage applications.

Applications

Supercapacitors have characteristics ranging from traditional capacitors and batteries. As a result, supercapacitors can be used like a secondary battery when applied in a DC circuit. These devices are best suited for use in low voltage DC hold-up applications such as embedded microprocessor systems with flash memory.

Benefits

- Rectangular case
- Wide range of temperature from -25°C to +70°C (all types except FMR) and -40°C to +85°C (FMR type)
- Maintenance free
- Maximum operating voltages of 3.5, 3.6, 5.5, and 6.5 VDC
- Highly reliable against liquid leakage
- Lead-free and RoHS compliant
- Leads can be transverse mounted

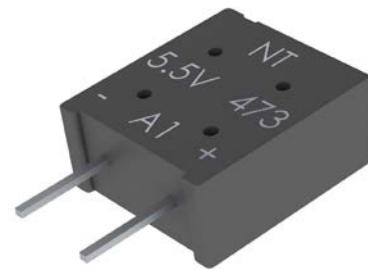

Part Number System

| FM | OH | 223 | Z | F | TP | 16 |
|-------------------------|----------------------------------------------|---------------------------------------------------------------------------------------------------------------------|-----------------------|---------------|-------------------------------------------------------|----------------------------|
| Series | Maximum Operating Voltage | Capacitance Code | Capacitance Tolerance | Environmental | Tape Type | Height (excluding lead) |
| FM FME FMR FMC | OV = 3.5 VDC OH = 5.5 VDC OJ = 6.5 VDC | First two digits represent significant figures. Third digit specifies number of zeros to follow μF code. | Z = -20/+80% | F = Lead-free | TP = AMMO L1 = Transverse mounting Blank = Bulk | 18 = 18 mm Blank = Bulk |

Dimensions – Millimeters

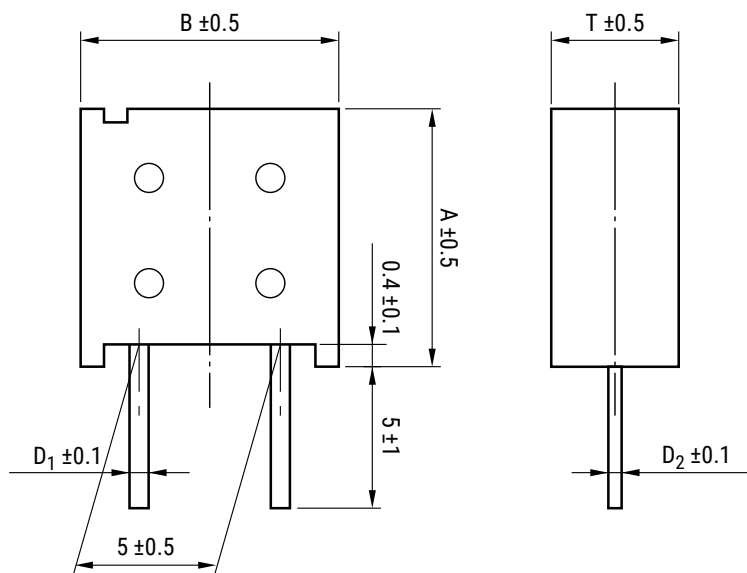

| Part Number | A | B | T | D ₁ | D ₂ |
|-------------|------|------|-----|----------------|----------------|
| FM0H103ZF | 11.5 | 10.5 | 5.0 | 0.5 | 0.4 |
| FM0H223ZF | 11.5 | 10.5 | 5.0 | 0.5 | 0.4 |
| FM0H473ZF | 11.5 | 10.5 | 5.0 | 0.5 | 0.4 |
| FM0H104ZF | 11.5 | 10.5 | 6.5 | 0.5 | 0.4 |
| FM0H224ZF | 11.5 | 10.5 | 6.5 | 0.5 | 0.4 |
| FM0V473ZF | 11.5 | 10.5 | 5.0 | 0.5 | 0.4 |
| FM0V104ZF | 11.5 | 10.5 | 5.0 | 0.5 | 0.4 |
| FM0V224ZF | 11.5 | 10.5 | 6.5 | 0.5 | 0.4 |
| FM0J473ZF | 11.5 | 10.5 | 6.5 | 0.5 | 0.4 |
| FME0H223ZF | 11.5 | 10.5 | 5.0 | 0.5 | 0.4 |
| FME0H473ZF | 11.5 | 10.5 | 5.0 | 0.5 | 0.4 |
| FMR0H473ZF | 11.5 | 10.5 | 6.5 | 0.5 | 0.4 |
| FMR0H104ZF | 11.5 | 10.5 | 6.5 | 0.5 | 0.4 |
| FMR0V104ZF | 11.5 | 10.5 | 6.5 | 0.5 | 0.4 |
| FMR0V334ZF | 11.5 | 10.5 | 6.5 | 0.5 | 0.4 |
| FMR0V474ZF | 15.0 | 14.0 | 9.0 | 0.6 | 0.6 |
| FMC0H473ZF | 11.5 | 10.5 | 5.0 | 0.5 | 0.4 |
| FMC0H104ZF | 11.5 | 10.5 | 6.5 | 0.5 | 0.4 |
| FMC0H334ZF | 15.0 | 14.0 | 9.0 | 0.6 | 0.6 |

Lead Terminal Forming



Add "L1" to the end of bulk part number for transverse mounting option

Performance Characteristics

Supercapacitors should not be used for applications such as ripple absorption because of their high internal resistance (several hundred mΩ to a hundred Ω) compared to aluminum electrolytic capacitors. Thus, its main use would be similar to that of secondary battery such as power back-up in DC circuit. The following list shows the characteristics of supercapacitors as compared to aluminum electrolytic capacitors for power back-up and secondary batteries.

| | Secondary Battery | | Capacitor | |
|----------------------------------|-------------------------|------------------------------------------|-----------------------|------------------------------------|
| | NiCd | Lithium Ion | Aluminum Electrolytic | Supercapacitor |
| Back-up ability | - | - | - | - |
| Eco-hazard | Cd | - | - | - |
| Operating Temperature Range | -20 to +60°C | -20 to +50°C | -55 to +105°C | -40 to +85°C (FR, FT, FMR Type) |
| Charge Time | Few hours | Few hours | Few seconds | Few seconds |
| Charge/Discharge Life Time | Approximately 500 times | Approximately 500 to 1,000 times | Limitless (*1) | Limitless (*1) |
| Restrictions on Charge/Discharge | Yes | Yes | None | None |
| Flow Soldering | Not applicable | Not applicable | Applicable | Applicable |
| Automatic Mounting | Not applicable | Not applicable | Applicable | Applicable (FM and FC series) |
| Safety Risks | Leakage, explosion | Leakage, combustion, explosion, ignition | Heat-up, explosion | Gas emission (*2) |

(*1) Aluminum electrolytic capacitors and supercapacitors have limited lifetime. However, when used under proper conditions, both can operate within a predetermined lifetime.

(*2) There is no harm as it is a mere leak of water vapor which transitioned from water contained in the electrolyte (diluted sulfuric acid). However, application of abnormal voltage surge exceeding maximum operating voltage may result in leakage and explosion.

Typical Applications

| Intended Use (Guideline) | Power Supply (Guideline) | Application | Examples of Equipment | Series |
|--------------------------|--------------------------|-----------------------------------|------------------------------------------------------------|-----------|
| Long time back-up | 500 μA and below | CMOS microcomputer, IC for clocks | CMOS microcomputer, static RAM/DTS (digital tuning system) | FM series |

Environmental Compliance

All KEMET supercapacitors are RoHS compliant.



Table 1 – Ratings & Part Number Reference

| Part Number | Maximum Operating Voltage (VDC) | Nominal Capacitance | | Maximum ESR at 1 kHz (Ω) | Maximum Current at 30 Minutes (mA) | Voltage Holding Characteristic Minimum (V) | Weight (g) |
|-------------|---------------------------------|---------------------|----------------------|-----------------------------------|------------------------------------|--------------------------------------------|------------|
| | | Charge System (F) | Discharge System (F) | | | | |
| FM0V473ZF | 3.5 | 0.047 | 0.06 | 200 | 0.042 | - | 1.3 |
| FMR0V104ZF | 3.5 | 0.10 | - | 50 | 0.090 | - | 1.6 |
| FM0V104ZF | 3.5 | 0.10 | 0.13 | 100 | 0.090 | - | 1.3 |
| FM0V224ZF | 3.5 | 0.22 | 0.30 | 100 | 0.20 | - | 1.6 |
| FM0H103ZF | 5.5 | 0.01 | 0.014 | 300 | 0.015 | 4.2 | 1.3 |
| FME0H223ZF | 5.5 | 0.022 | 0.028 | 40 | 0.033 | - | 1.3 |
| FM0H223ZF | 5.5 | 0.022 | 0.028 | 200 | 0.033 | 4.2 | 1.3 |
| FME0H473ZF | 5.5 | 0.047 | 0.06 | 20 | 0.071 | - | 1.3 |
| FMC0H473ZF | 5.5 | 0.047 | 0.06 | 100 | 0.071 | 4.2 | 1.3 |
| FM0H473ZF | 5.5 | 0.047 | 0.06 | 200 | 0.071 | 4.2 | 1.3 |
| FMR0H473ZF | 5.5 | 0.047 | 0.062 | 200 | 0.071 | 4.2 | 1.6 |
| FMR0H104ZF | 5.5 | 0.10 | - | 50 | 0.15 | 4.2 | 1.6 |
| FMR0V334ZF | 3.6 | - | 0.33 | 50 | 0.3 | - | 1.6 |
| FMR0V474ZF | 3.6 | - | 0.47 | 25 | 0.42 | - | 3.5 |
| FMC0H104ZF | 5.5 | 0.10 | 0.13 | 50 | 0.15 | 4.2 | 1.6 |
| FM0H104ZF | 5.5 | 0.10 | 0.13 | 100 | 0.15 | 4.2 | 1.6 |
| FM0H224ZF | 5.5 | - | 0.22 | 100 | 0.33 | 4.2 | 1.6 |
| FMC0H334ZF | 5.5 | - | 0.33 | 25 | 0.50 | 4.2 | 3.5 |
| FM0J473ZF | 6.5 | 0.047 | 0.062 | 200 | 0.071 | - | 1.6 |

Specifications – All Types Except FMR

| Item | FM 5.5 V Type, 3.5 V Type, 6.5 V Type, FMC Type | FME Type | Test Conditions (conforming to JIS C 5160-1) | |
|--------------------------------------------------------------------------------------------------------------------------------------------------------------------------------------------------------------------------------------------------------------------------------------------------------------------------------------------------------------|--------------------------------------------------------------|--------------------------------------------------------------|----------------------------------------------------------------------------------------------------------------------|----------------------------------------------------------------------------------------------------------------------|
| Category Temperature Range | -25°C to +70°C | -25°C to +70°C | | |
| Maximum Operating Voltage | 5.5 VDC, 3.5 VDC, 6.5 VDC | 5.5 VDC | | |
| Capacitance | Refer to Table 1 | Refer to Table 1 | Refer to "Measurement Conditions" | |
| Capacitance Allowance | +80%, -20% | +80%, -20% | Refer to "Measurement Conditions" | |
| ESR | Refer to Table 1 | Refer to Table 1 | Measured at 1 kHz, 10 mA; See also "Measurement Conditions" | |
| Current (30 minutes value) | Refer to Table 1 | Refer to Table 1 | Refer to "Measurement Conditions" | |
| Surge | Capacitance | > 90% of initial ratings | > 90% of initial ratings | |
| | ESR | ≤ 120% of initial ratings | ≤ 120% of initial ratings | |
| | Current (30 minutes value) | ≤ 120% of initial ratings | ≤ 120% of initial ratings | |
| | Appearance | No obvious abnormality | No obvious abnormality | |
| Surge voltage: 4.0 V (3.5 V type) 6.3 V (5.5 V type) 7.4 V (6.5 V type) Charge: 30 seconds Discharge: 9 minutes 30 seconds Number of cycles: 1,000 Series resistance: 0.010 F 1,500 Ω 0.022 F 560 Ω 0.047 F 300 Ω 0.068 F 240 Ω 0.10 F 150 Ω 0.22 F 56 Ω 0.33 F 51 Ω Discharge resistance: 0 Ω Temperature: 70±2°C | | | | |
| Characteristics in Different Temperature | Capacitance | Phase 2 | ≥ 50% of initial value | Conforms to 4.17 Phase 1: +25±2°C Phase 2: -25±2°C Phase 4: +25±2°C Phase 5: +70±2°C Phase 6: +25±2°C |
| | ESR | Phase 2 | ≤ 400% of initial value | |
| | Capacitance | Phase 3 | | |
| | ESR | Phase 3 | | |
| | Capacitance | Phase 5 | ≤ 200% of initial value | |
| | ESR | Phase 5 | Satisfy initial ratings | |
| | Current (30 minutes value) | Phase 5 | ≤ 1.5 CV (mA) | |
| | Capacitance | Phase 6 | Within ±20% of initial value | |
| ESR | Phase 6 | Satisfy initial ratings | | |
| Current (30 minutes value) | Phase 6 | Satisfy initial ratings | | |
| Vibration Resistance | Capacitance | Satisfy initial ratings | Satisfy initial ratings | Conforms to 4.13 Frequency: 10 to 55 Hz Testing Time: 6 hours |
| | ESR | | | |
| | Current (30 minutes value) | | | |
| | Appearance | | | |
| Solderability | Over 3/4 of the terminal should be covered by the new solder | Over 3/4 of the terminal should be covered by the new solder | Conforms to 4.11 Solder temp: +245±5°C Dipping time: 5±0.5 seconds 1.6 mm from the bottom should be dipped. | |

Specifications – All Types Except FMR cont.

| Item | | FM 5.5 V Type, 3.5 V Type, 6.5 V Type, FMC Type | FME Type | Test Conditions (conforming to JIS C 5160-1) |
|---------------------------------------------------------------------|-------------------------------------------------------------------------------------------------------------------------------------------------------------------------------------------------------------------|----------------------------------------------------|------------------------------|-----------------------------------------------------------------------------------------------------------------------------------------------------------------------|
| Solder Heat Resistance | Capacitance | Satisfy initial ratings | Satisfy initial ratings | Conforms to 4.10 Solder temp: +260±10°C Dipping time: 10±1 seconds 1.6 mm from the bottom should be dipped. |
| | ESR | | | |
| | Current (30 minutes value) | | | |
| | Appearance | | | |
| Temperature Cycle | Capacitance | Satisfy initial ratings | Satisfy initial ratings | Conforms to 4.12 Temperature Condition: -25°C » Room temperature » +70°C » Room temperature Number of cycles: 5 cycles |
| | ESR | | | |
| | Current (30 minutes value) | | | |
| | Appearance | | | |
| High Temperature and High Humidity Resistance | Capacitance | Within ±20% of initial value | Within ±20% of initial value | Conforms to 4.14 Temperature: +40±2°C Relative humidity: 90 to 95% RH Testing time: 240±8 hours |
| | ESR | ≤ 120% of initial ratings | ≤ 120% of initial ratings | |
| | Current (30 minutes value) | ≤ 120% of initial ratings | ≤ 120% of initial ratings | |
| | Appearance | No obvious abnormality | No obvious abnormality | |
| High Temperature Load | Capacitance | Within ±30% of initial value | Within ±30% of initial value | Conforms to 4.15 Temperature: +70±2°C Voltage applied: Maximum operating voltage Series protection resistance: 0 Ω Testing time: 1,000 +48 (+48/-0) hours |
| | ESR | < 200% of initial ratings | < 200% of initial ratings | |
| | Current (30 minutes value) | < 200% of initial ratings | < 200% of initial ratings | |
| | Appearance | No obvious abnormality | No obvious abnormality | |
| Self Discharge Characteristics (Voltage Holding Characteristics) | 5.5 V type: Voltage between terminal leads > 4.2 V Not specified 3.5 V type: Not specified 6.5 V type: Not specified | | / | Charging condition Voltage applied: 5.0 VDC (Terminal at the case side must be negative) Series resistance: 0 Ω Charging time: 24 hours |
| | | | | Storage Let stand for 24 hours in condition described below with terminals opened. Ambient temperature: < 25°C Relative humidity: < 70% RH |

Specifications – FMR Type

| Item | | FMR Type | | Test Conditions (conforming to JIS C 5160-1) |
|------------------------------------------|----------------------------|--------------------------------------------------------------|----------------------------------|-------------------------------------------------------------------------------------------------------------------------------------------------------------------------------------------------------------------------------------------------------------------------------------------------------------|
| Category Temperature Range | | -40°C to +85°C | | |
| Maximum Operating Voltage | | 5.5 VDC, 3.5 VDC, 3.6 VDC | | |
| Capacitance | | Refer to Table 1 | | Refer to "Measurement Conditions" |
| Capacitance Allowance | | +80%, -20% | | Refer to "Measurement Conditions" |
| ESR | | Refer to Table 1 | | Measured at 1 kHz, 10 mA; See also "Measurement Conditions" |
| Current (30 minutes value) | | Refer to Table 1 | | Refer to "Measurement Conditions" |
| Surge | Capacitance | More than 90% of initial ratings | | Surge voltage: 4.0 V (3.5 & 3.6 V type) 6.3 V (5.5 V type) Charge: 30 seconds Discharge: 9 minutes 30 seconds Number of cycles: 1,000 Series resistance: 0.047 F 300 Ω 0.10 F 150 Ω 0.33 F 56 Ω 0.47 F 30 Ω Discharge resistance: 0 Ω Temperature: 85±2°C |
| | ESR | Not to exceed 120% of initial ratings | | |
| | Current (30 minutes value) | Not to exceed 120% of initial ratings | | |
| | Appearance | No obvious abnormality | | |
| Characteristics in Different Temperature | Capacitance | Phase 2 | 50% higher than initial value | Conforms to 4.17 Phase 1: +25±2°C Phase 2: -25 ±2°C Phase 3: -40 ±2°C Phase 4: +25 ±2°C Phase 5: +85 ±2°C Phase 6: +25 ±2°C |
| | ESR | | 400% or less than initial value | |
| | Capacitance | Phase 3 | 30% or higher than initial value | |
| | ESR | | 700% or less than initial value | |
| | Capacitance | Phase 5 | 200% or less than initial value | |
| | ESR | | Satisfy initial ratings | |
| | Current (30 minutes value) | | 1.5 CV (mA) or below | |
| | Capacitance | Phase 6 | Within ±20% of initial value | |
| | ESR | | Satisfy initial ratings | |
| | Current (30 minutes value) | | Satisfy initial ratings | |
| Lead Strength (tensile) | | No terminal damage | | Conforms to 4.9 |
| Vibration Resistance | Capacitance | Satisfy initial ratings | | Conforms to 4.13 Frequency: 10 to 55 Hz Testing Time: 6 hours |
| | ESR | | | |
| | Current (30 minutes value) | | | |
| | Appearance | No obvious abnormality | | |
| Solderability | | Over 3/4 of the terminal should be covered by the new solder | | Conforms to 4.11 Solder temp: +245 ±5°C Dipping time: 5±0.5 seconds 1.6 mm from the bottom should be dipped. |
| Solder Heat Resistance | Capacitance | Satisfy initial ratings | | Conforms to 4.10 Solder temp: +260 ±10°C Dipping time: 10±1 seconds 1.6 mm from the bottom should be dipped. |
| | ESR | | | |
| | Current (30 minutes value) | | | |
| | Appearance | No obvious abnormality | | |
| Temperature Cycle | Capacitance | Satisfy initial ratings | | Conforms to 4.12 Temperature Condition: -40°C » Room temperature » +85°C » Room temperature Number of cycles: 5 cycles |
| | ESR | | | |
| | Current (30 minutes value) | | | |
| | Appearance | No obvious abnormality | | |

Specifications – FMR Type cont.

| Item | | FMR Type | Test Conditions (conforming to JIS C 5160-1) | |
|---------------------------------------------------------------------|----------------------------|---------------------------------------|------------------------------------------------------------------------------------------------------------------------------------------------------------------------------------------------|-------------------------------------------------------------------------------------------------------------------------------------------------------------------------------------|
| High Temperature and High Humidity Resistance | Capacitance | Within $\pm 20\%$ of initial value | Conforms to 4.14 Temperature: $+40 \pm 2^\circ\text{C}$ Relative humidity: 90 to 95% RH Testing time: 240 ± 8 hours | |
| | ESR | Not to exceed 120% of initial ratings | | |
| | Current (30 minutes value) | Not to exceed 120% of initial ratings | | |
| | Appearance | No obvious abnormality | | |
| High Temperature Load | Capacitance | Within $\pm 30\%$ of initial value | Conforms to 4.15 Temperature: $+85 \pm 2^\circ\text{C}$ Voltage applied: Maximum operating voltage Series protection resistance: 0Ω Testing time: 1,000 +48 (+48/-0) hours | |
| | ESR | Below 200% of initial ratings | | |
| | Current (30 minutes value) | Below 200% of initial ratings | | |
| | Appearance | No obvious abnormality | | |
| Self Discharge Characteristics (Voltage Holding Characteristics) | | 5.5 V type: | Voltage between terminal leads higher than 4.2 V | Charging condition Voltage applied: 5.0 VDC (Terminal at the case side must be negative) Series resistance: 0Ω Charging time: 24 hours |
| | | 3.5 V type: 3.6 V type: | Not specified | Storage Let stand for 24 hours in condition described below with terminals opened. Ambient temperature: Lower than 25°C Relative humidity: Lower than 70% RH |

Construction

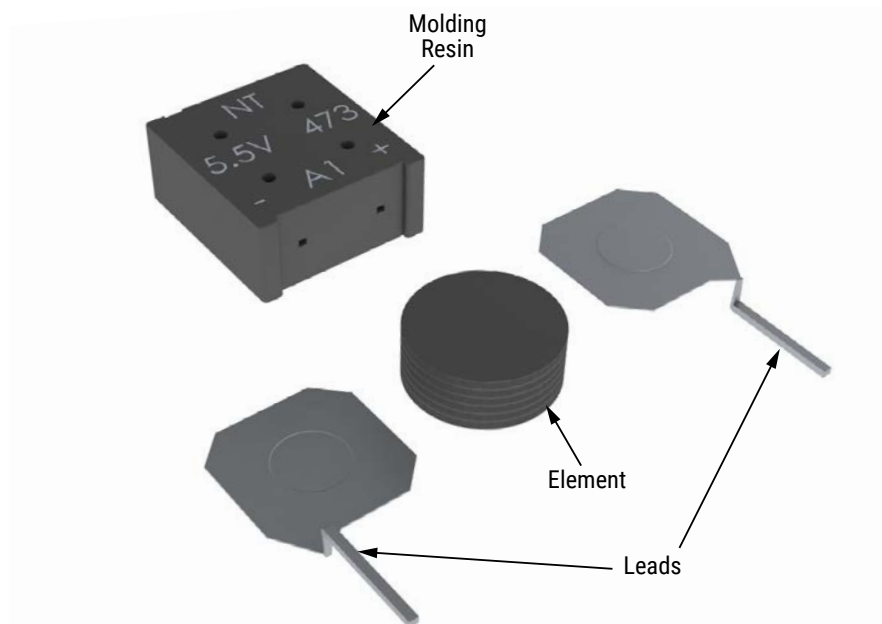

Marking

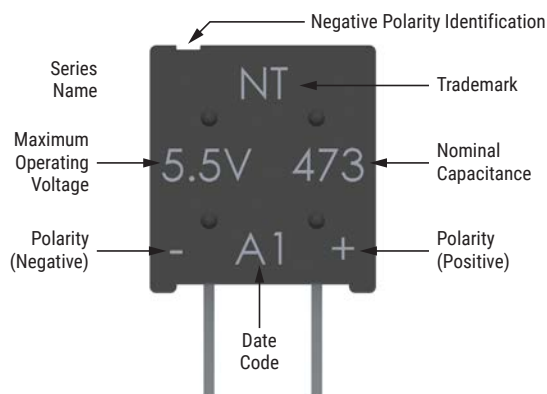

Packaging Quantities

| Part Number | Bulk Quantity per Box Straight Lead | Bulk Quantity per Box L1 Lead Option | Ammo Pack Quantity |
|-------------|----------------------------------------|-----------------------------------------|--------------------|
| FM0H103ZF | 1,000 pieces | 1,000 pieces | 1,000 pieces |
| FM0H223ZF | 1,000 pieces | 1,000 pieces | 1,000 pieces |
| FM0H473ZF | 1,000 pieces | 1,000 pieces | 1,000 pieces |
| FM0H104ZF | 1,000 pieces | 800 pieces | 1,000 pieces |
| FM0H224ZF | 1,000 pieces | 800 pieces | 1,000 pieces |
| FM0V473ZF | 1,000 pieces | 1,000 pieces | 1,000 pieces |
| FM0V104ZF | 1,000 pieces | 1,000 pieces | 1,000 pieces |
| FM0V224ZF | 1,000 pieces | 800 pieces | 1,000 pieces |
| FM0J473ZF | 1,000 pieces | 800 pieces | 1,000 pieces |
| FME0H223ZF | 1,000 pieces | 1,000 pieces | 1,000 pieces |
| FME0H473ZF | 1,000 pieces | 1,000 pieces | 1,000 pieces |
| FMR0H473ZF | 1,000 pieces | 1,000 pieces | 1,000 pieces |
| FMR0H104ZF | 1,000 pieces | 1,000 pieces | 1,000 pieces |
| FMR0V104ZF | 1,000 pieces | 800 pieces | 1,000 pieces |
| FMR0V334ZF | 1,000 pieces | 800 pieces | 1,000 pieces |
| FMR0V474ZF | 400 pieces | 300 pieces | 400 pieces |
| FMC0H473ZF | 1,000 pieces | 1,000 pieces | 1,000 pieces |
| FMC0H104ZF | 1,000 pieces | 1,000 pieces | 1,000 pieces |
| FMC0H334ZF | 400 pieces | 300 pieces | 400 pieces |

Ammo Pack Taping Format (Except FMC0H334ZFTP, FMR0V474ZFTP)

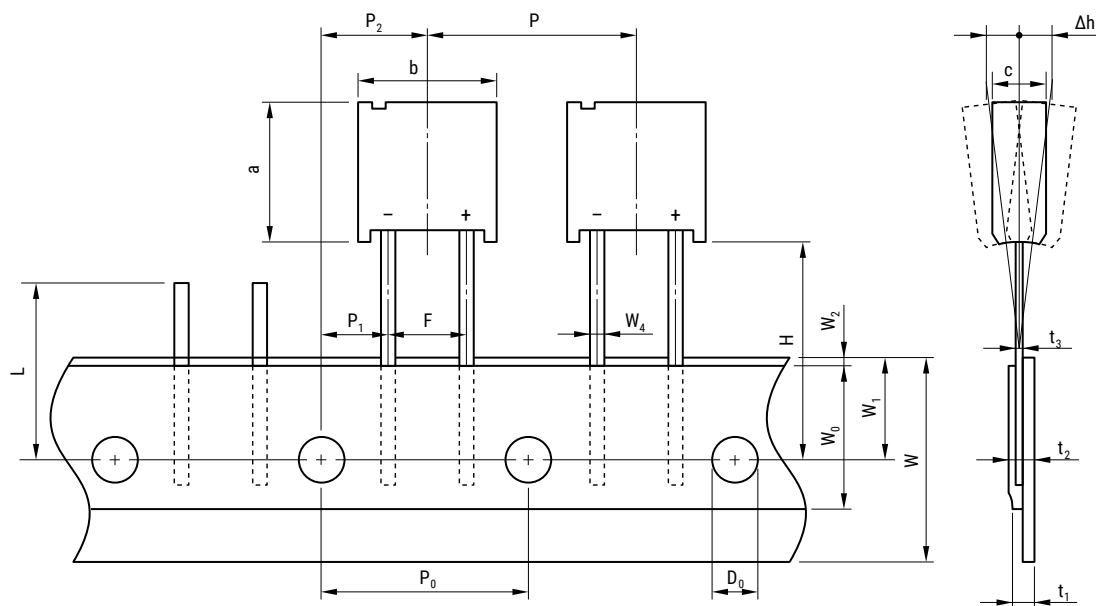

Ammo Pack Taping Specifications (Except FMC0H334ZFTP, FMR0V474ZFTP)

| Item | Symbol | Dimensions (mm) |
|---------------------------------------------------------|------------|-----------------------------|
| Component Height | a | 11.5±0.5 |
| Component Width | b | 10.5±0.5 |
| Component Thickness | c | Refer to "Dimensions" table |
| Lead-Wire Width | W_4 | 0.5±0.1 |
| Lead-Wire Thickness | t_3 | 0.4±0.1 |
| Component Pitch | P | 12.7±1.0 |
| Sprocket Hole Pitch | P_0 | 12.7±0.3 |
| Sprocket Hole Center to Lead Center | P_1 | 3.85±0.7 |
| Sprocket Hole Center to Component Center | P_2 | 6.35±0.7 |
| Lead Spacing | F | 5.0±0.5 |
| Component Alignment (side/side) | Δh | 2.0 Maximum |
| Carrier Tape Width | W | 18.0+1.0/-0.5 |
| Hold-Down Tape Width | W_0 | 12.5 Minimum |
| Sprocket Hole Position | W_1 | 9.0±0.5 |
| Hold-Down Tape Position | W_2 | 3.0 Maximum |
| Height to Seating Plane (lead length) | H | 16.0±0.5/18.0±0.5 |
| Sprocket Hole Diameter | D_0 | ∅ 4.0±0.2 |
| Carrier Tape Thickness | t_1 | 0.7±0.2 |
| Total Thickness (Carrier Tape, Hold-Down Tape and Lead) | t_2 | 1.5 Maximum |
| Cut Out Length | L | 11.0 Maximum |

Ammo Pack Taping Format (FMC0H334ZFTP, FMR0V474ZFTP)

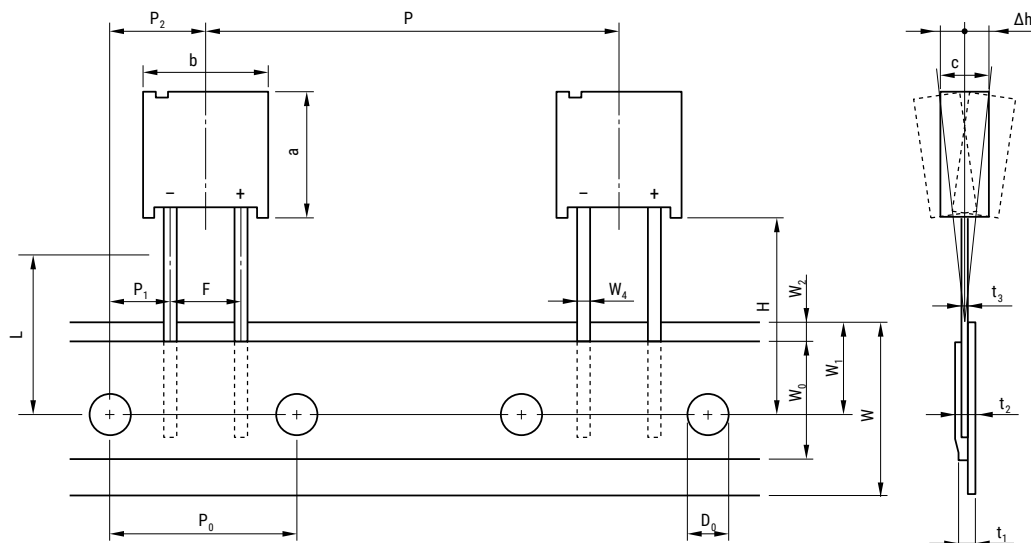

Ammo Pack Taping Specifications (FMC0H334ZFTP, FMR0V474ZFTP)

| Item | Symbol | Dimensions (mm) |
|---------------------------------------------------------|------------|-------------------|
| Component Height | a | 15.0±0.5 |
| Component Width | b | 14.0±0.5 |
| Component Thickness | c | 9.0±0.5 |
| Lead-Wire Width | W_4 | 0.6±0.1 |
| Lead-Wire Thickness | t_3 | 0.6±0.1 |
| Component Pitch | P | 25.4±1.0 |
| Sprocket Hole Pitch | P_0 | 12.7±0.3 |
| Sprocket Hole Center to Lead Center | P_1 | 3.85±0.7 |
| Sprocket Hole Center to Component Center | P_2 | 6.35±0.7 |
| Lead Spacing | F | 5.0±0.5 |
| Component Alignment (side/side) | Δh | 2.0 Maximum |
| Carrier Tape Width | W | 18.0+1.0/-0.5 |
| Hold-Down Tape Width | W_0 | 12.5 Minimum |
| Sprocket Hole Position | W_1 | 9.0±0.5 |
| Hold-Down Tape Position | W_2 | 3.0 Maximum |
| Height to Seating Plane (lead length) | H | 16.0±0.5/18.0±0.5 |
| Sprocket Hole Diameter | D_0 | ∅ 4.0±0.2 |
| Carrier Tape Thickness | t_1 | 0.67±0.2 |
| Total Thickness (Carrier Tape, Hold-Down Tape and Lead) | t_2 | 1.7 Maximum |
| Cut Out Length | L | 11.0 Maximum |

Measurement Conditions

Capacitance (Charge System)

Capacitance is calculated from expression (9) by measuring the charge time constant (τ) of the capacitor (C). Prior to measurement, the capacitor is discharged by shorting both pins of the device for at least 30 minutes. In addition, use the polarity indicator on the device to determine correct orientation of capacitor for charging.

$$\text{Capacitance: } C = \frac{\tau}{R_c} \text{ (F) (9)}$$

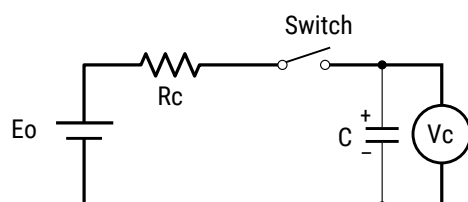

Eo: 3.0 (V) Product with maximum operating voltage of 3.5 V
 5.0 (V) Product with maximum operating voltage of 5.5 V
 6.0 (V) Product with maximum operating voltage of 6.5 V
 10.0 (V) Product with maximum operating voltage of 11 V
 12.0 (V) Product with maximum operating voltage of 12 V
 τ : Time from start of charging until V_c becomes 0.632 E_o (V)
 (seconds)
 R_c : See table below (Ω).

Charge Resistor Selection Guide

| Cap | FA | FE | FS | FY | | FR | FM, FME FMR | FMC | FG, FGR | FGH | FT | FC, FCS | HV |
|---------|----------------|----------------|----------------|----------------|----------------|----------------|------------------------------------|----------------|----------------|-----------|--------------|-----------|-----------|
| | | | | FYD | FYH | | | | | | | | |
| 0.010 F | - | - | - | - | - | - | 5,000 Ω | - | 5,000 Ω | - | - | - | - |
| 0.022 F | 1,000 Ω | - | 1,000 Ω | 2,000 Ω | 2,000 Ω | 2,000 Ω | 2,000 Ω | - | 2,000 Ω | - | - | Discharge | - |
| 0.033 F | - | - | - | - | - | - | Discharge | - | - | - | - | - | - |
| 0.047 F | 1,000 Ω | 1,000 Ω | 1,000 Ω | 2,000 Ω | 1,000 Ω | 1,000 Ω | 2000 Ω | 1,000 Ω | 2,000 Ω | - | - | - | - |
| 0.10 F | 510 Ω | 510 Ω | 510 Ω | 1,000 Ω | 510 Ω | 1,000 Ω | 1000 Ω | 1,000 Ω | 1,000 Ω | Discharge | 510 Ω | Discharge | - |
| 0.22 F | 200 Ω | 200 Ω | 200 Ω | 510 Ω | 510 Ω | 510 Ω | 0H: Discharge 0V: 1000 Ω | - | 1,000 Ω | Discharge | 200 Ω | Discharge | - |
| 0.33 F | - | - | - | - | - | - | - | Discharge | - | - | - | - | - |
| 0.47 F | 100 Ω | 100 Ω | 100 Ω | 200 Ω | 200 Ω | 200 Ω | - | - | 1,000 Ω | Discharge | 100 Ω | Discharge | - |
| 1.0 F | 51 Ω | 51 Ω | 100 Ω | 100 Ω | 100 Ω | 100 Ω | - | - | 510 Ω | Discharge | 100 Ω | Discharge | Discharge |
| 1.4 F | - | - | - | 200 Ω | - | - | - | - | - | - | - | - | - |
| 1.5 F | - | 51 Ω | - | - | - | - | - | - | 510 Ω | - | - | - | - |
| 2.2 F | - | - | - | 100 Ω | - | - | - | - | 200 Ω | - | 51 Ω | - | - |
| 2.7 F | - | - | - | - | - | - | - | - | - | - | - | - | Discharge |
| 3.3 F | - | - | - | - | - | - | - | - | - | - | 51 Ω | - | - |
| 4.7 F | - | - | - | - | - | - | - | - | 100 Ω | - | - | - | Discharge |
| 5.0 F | - | - | 100 Ω | - | - | - | - | - | - | - | - | - | - |
| 5.6 F | - | - | - | - | - | - | - | - | - | - | 20 Ω | - | - |
| 10.0 F | - | - | - | - | - | - | - | - | - | - | - | - | Discharge |
| 22.0 F | - | - | - | - | - | - | - | - | - | - | - | - | Discharge |
| 50.0 F | - | - | - | - | - | - | - | - | - | - | - | - | Discharge |
| 100.0 F | - | - | - | - | - | - | - | - | - | - | - | - | Discharge |
| 200.0 F | - | - | - | - | - | - | - | - | - | - | - | - | Discharge |

*Capacitance values according to the constant current discharge method.

*HV Series capacitance is measured by discharge system.

Measurement Conditions cont.

Capacitance (Discharge System)

As shown in the diagram below, charging is performed for a duration of 30 minutes once the voltage of the capacitor terminal reaches 5.5 V. Then, use a constant current load device and measure the time for the terminal voltage to drop from 3.0 to 2.5 V upon discharge at 0.22 mA per 0.22 F, for example, and calculate the static capacitance according to the equation shown below.

Note: The current value is 1 mA discharged per 1 F.

$$C = \frac{I \times (T_2 - T_1)}{V_1 - V_2} \text{ (F)}$$

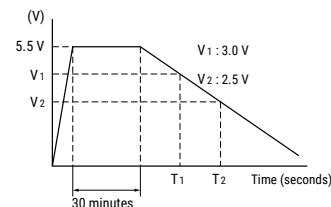
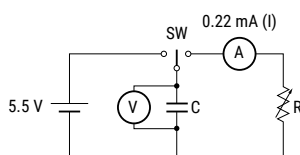

Capacitance (Discharge System – 3.5 V, 3.6 V)

As shown in the diagram below, charging is performed for a duration of 30 minutes once the voltage of the capacitor terminal reaches 3.5 V (3.6 V). Then, use a constant current load device and measure the time for the terminal voltage to drop from 1.8 to 1.5 V upon discharge at 1.0 mA per 1.0 F, for example, and calculate the static capacitance according to the equation shown below.

$$C = \frac{I \times (T_2 - T_1)}{V_1 - V_2} \text{ (F)}$$

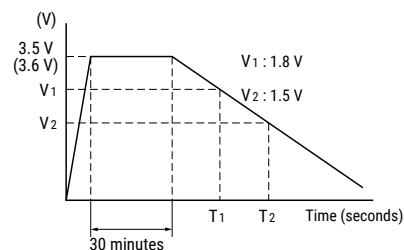
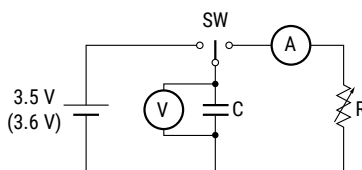

Capacitance (Discharge System – HV Series)

As shown in the diagram below, charging is performed for a duration of 30 minutes once the voltage of the capacitor terminal reaches maximum operating voltage. Then, use a constant current load device and measure the time for the terminal voltage to drop from 2.0 to 1.5 V upon discharge at 1.0 mA per 1.0 F, and calculate the static capacitance according to the equation shown below.

$$C = \frac{I \times (T_2 - T_1)}{V_1 - V_2} \text{ (F)}$$

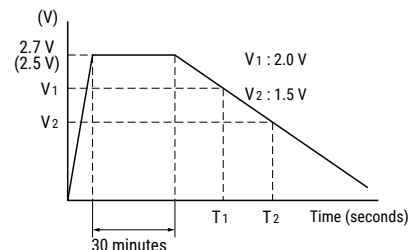
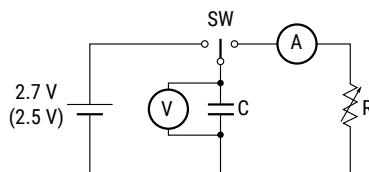

Measurement Conditions cont.

Equivalent Series Resistance (ESR)

ESR shall be calculated from the equation below.

$$ESR = \frac{V_C}{0.01} (\Omega)$$

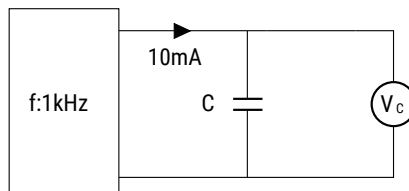

Current (at 30 minutes after charging)

Current shall be calculated from the equation below. Prior to measurement, both lead terminals must be short-circuited for a minimum of 30 minutes. The lead terminal connected to the metal can case is connected to the negative side of the power supply.

- Eo: 2.5 VDC (HV Series 50 F)
- 2.7 VDC (HV Series except 50 F)
- 3.0 VDC (3.5 V type)
- 3.6 VDC (3.6 V type)
- 5.0 VDC (5.5 V type)
- 6.0 VDC (6.5 V type)
- 10.0 VDC (11 V type)
- 12.0 VDC (12 V type)

$$Current = \frac{V_R}{R_C} (A)$$

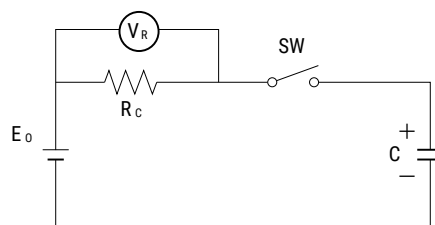

- Rc: 1,000 Ω (0.01 F, 0.022 F, 0.047 F)
- 100 Ω (0.10 F, 0.22 F, 0.33 F, 0.47 F)
- 10 Ω (1.0 F, 1.4 F, 1.5 F, 2.2 F, 3.3 F, 4.7 F, 5.6 F)
- 2.2 Ω (HV Series)
- However, FS Series 11 V type and 12 V type
- 100 Ω 0.47 F, 1.0 F
- 10 Ω 5.0 F

Self-Discharge Characteristic (0H – 5.5 V Products)

The self-discharge characteristic is measured by charging a voltage of 5.0 VDC (charge protection resistance: 0 Ω) according to the capacitor polarity for 24 hours, then releasing between the pins for 24 hours and measuring the pin-to-pin voltage. The test should be carried out in an environment with an ambient temperature of 25° C or below and relative humidity of 70% RH or below. The soldering is checked.

4. Dismantling

There is a small amount of electrolyte stored within the capacitor. Do not attempt to dismantle as direct skin contact with the electrolyte will cause burning. This product should be treated as industrial waste and not is not to be disposed of by fire.

Notes on Using Supercapacitors or Electric Double-Layer Capacitors (EDLCs)

1. Circuitry Design

1.1 Useful life

The FC Series Supercapacitor (EDLC) uses an electrolyte in a sealed container. Water in the electrolyte can evaporate while in use over long periods of time at high temperatures, thus reducing electrostatic capacity which in turn will create greater internal resistance. The characteristics of the supercapacitor can vary greatly depending on the environment in which it is used. Basic breakdown mode is an open mode due to increased internal resistance.

1.2 Fail rate in the field

Based on field data, the fail rate is calculated at approximately 0.006 Fit. We estimate that unreported failures are ten times this amount. Therefore, we assume that the fail rate is below 0.06 Fit.

1.3 Exceeding maximum usable voltage

Performance may be compromised and in some cases leakage or damage may occur if applied voltage exceeds maximum working voltage.

1.4 Use of capacitor as a smoothing capacitor (ripple absorption)

As supercapacitors contain a high level of internal resistance, they are not recommended for use as smoothing capacitors in electrical circuits. Performance may be compromised and, in some cases, leakage or damage may occur if a supercapacitor is used in ripple absorption.

1.5 Series connections

As applied voltage balance to each supercapacitor is lost when used in series connection, excess voltage may be applied to some supercapacitors, which will not only negatively affect its performance but may also cause leakage and/or damage. Allow ample margin for maximum voltage or attach a circuit for applying equal voltage to each supercapacitor (partial pressure resistor/voltage divider) when using supercapacitors in series connection. Also, arrange supercapacitors so that the temperature between each capacitor will not vary.

1.6 Case Polarity

The supercapacitor is manufactured so that the terminal on the outer case is negative (-). Align the (-) symbol during use. Even though discharging has been carried out prior to shipping, any residual electrical charge may negatively affect other parts.

1.7 Use next to heat emitters

Useful life of the supercapacitor will be significantly affected if used near heat emitting items (coils, power transistors and posistors, etc.) where the supercapacitor itself may become heated.

1.8 Usage environment

This device cannot be used in any acidic, alkaline or similar type of environment.

Notes on Using Supercapacitors or Electric Double-Layer Capacitors (EDLCs) cont.

2. Mounting

2.1 Mounting onto a reflow furnace

Except for the FC series, it is not possible to mount this capacitor onto an IR / VPS reflow furnace. Do not immerse the capacitor into a soldering dip tank.

2.2 Flow soldering conditions

Keep solder under 260°C and soldering time to within 10 seconds when using the flow automatic soldering method. (Except for the FC and HV series)

2.3 Installation using a soldering iron

Care must be taken to prevent the soldering iron from touching other parts when soldering. Keep the tip of the soldering iron under 400°C and soldering time to within 3 seconds. Always make sure that the temperature of the tip is controlled. Internal capacitor resistance is likely to increase if the terminals are overheated.

2.4 Lead terminal processing

Do not attempt to bend or polish the capacitor terminals with sand paper, etc. Soldering may not be possible if the metallic plating is removed from the top of the terminals.

2.5 Cleaning, Coating, and Potting

Except for the FM series, cleaning, coating and potting must not be carried out. Consult KEMET if this type of procedure is necessary. Terminals should be dried at less than the maximum operating temperature after cleaning.

3. Storage

3.1 Temperature and humidity

Make sure that the supercapacitor is stored according to the following conditions: Temperature: 5 – 35°C (Standard 25°C), Humidity: 20 – 70% (Standard: 50%). Do not allow the build up of condensation through sudden temperature change.

3.2 Environment conditions

Make sure there are no corrosive gasses such as sulfur dioxide, as penetration of the lead terminals is possible. Always store this item in an area with low dust and dirt levels. Make sure that the packaging will not be deformed through heavy loading, movement and/or knocks. Keep out of direct sunlight and away from radiation, static electricity and magnetic fields.

3.3 Maximum storage period

This item may be stored up to one year from the date of delivery if stored at the conditions stated above.