

General Purpose AC/DC EMI Filter

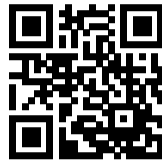

- Rated currents from 1 to 60 A
- High differential-mode attenuation
- Optional medical version (B type)
- Optional safety version (A type)



Performance indicators

Attenuation performance



Rated current [A]



Approvals & Compliances



Features and Benefits

- FN 2020 filters are designed for easy and fast chassis mounting
- FN 2020 B versions without capacitors to earth comply to 1MOP for ME (medical equipment) acc. IEC 60601-1
- FN 2020 A versions with low capacitance to earth for safety critical applications with necessity for low leakage currents
- All filters provide a general purpose conducted attenuation performance, based on chokes with high saturation resistance and excellent thermal behavior
- FN 2020 filters can be used to cover a broad range of usage and they offer a good size/ amperage ratio
- FN 2020 filters are also available as two- stage filters (FN 2060, FN 2070 series) for more noisy environment
- Various terminal options allow you to select the desired connection style

Technical Specifications

Rated voltage*	250 VAC, 50/60 Hz 250 VDC
Operating frequency	DC to 400 Hz
Rated currents	1 to 60 A @ 40°C max
High potential test voltage	P → N 1100 VDC for 2 sec (30 and 60 A types) P → PE 2000 VAC for 2 sec P → PE 2500 VAC for 2 sec (B types) P → N 760 VAC for 2 sec (1 to 20 A types)
Temperature range (operation and storage)	-25°C to +100°C (25/100/21)**
Certified to	UL 1283, CSA 22.2 No. 8 1986, IEC/EN 60939 (applies to AC and DC applications)
Flammability corresponding to	Laces for -07 version: UL 94 VW-1 Terminal plastic for -06/-08 version: UL 94 V-0 Grommet for -07 version: UL 94 V-0
Design corresponding to	UL 1283, CSA 22.2 No. 8 1986, IEC/EN 60939
Overvoltage category	II acc. IEC 60664-1
Pollution degree	2 acc. IEC 60664-1
Altitude	2000m (above derating applies)**

* maximum RMS operating voltage at rated frequency or the maximum DC operating voltage
 ** for dedicated requests exceeding this specification (e.g. -40 °C or higher altitude) please contact your local Schaffner Sales office







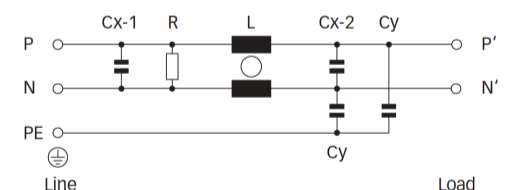























Typical Applications

- Electrical and electronic equipment
- Consumer goods
- Household equipment
- Medical equipment
- Office automation equipment
- Datacom equipment

Typical electrical schematic



Filter Selection Table

Filter*	Buy	Rated current @ 40°C (25°C)	Leakage current** @ 250 VAC/50 Hz (@ 120 VAC/60 Hz)	Power Loss @25°C/DC	Inductance*** L	Capacitance***		Resistance*** R	Input/Output connections			Weight [g]
						Cx	Cy					
		[A]	[mA]	[W]	[mH]	[µF]	[nF]	[kΩ]				
FN2020-1-..		1 (1.15)	0.66 (0.38)	0.8	12	0.15	4.7	1000	-06	-07		80
FN2020-3-..		3 (3.45)	0.66 (0.38)	1.2	2.5	0.15	4.7	1000	-06	-07		80
FN2020-6-..		6 (6.9)	0.66 (0.38)	1.5	1	0.15	4.7	1000	-06	-07		80
FN2020-10-..		10 (11.5)	0.66 (0.38)	2.9	0.8	0.15	4.7	1000	-06	-07		85
FN2020-12-..		12 (13.8)	0.66 (0.38)	3.6	0.7	0.15	4.7	1000	-06	-07		85
FN2020-16-..		16 (18.4)	0.66 (0.38)	2.5	0.65	0.15	4.7	1000	-06	-07	-08	140
FN2020-20-..		20 (23)	0.66 (0.38)	3.8	0.6	0.15	4.7	1000	-06		-08	210
FN2020-30-08		30 (34.5)	0.79 (0.45)	6.3	0.67	0.47	10	470			-08	470
FN2020-60-24		60 (69)	0.79 (0.45)	14.7	1	1.5	10	220			-24	1100
FN2020A-1-..		1 (1.15)	0.07 (0.04)	0.8	12	0.15	0.47	1000	-06	-07		80
FN2020A-3-..		3 (3.45)	0.07 (0.04)	1.2	2.5	0.15	0.47	1000	-06	-07		80
FN2020A-6-..		6 (6.9)	0.07 (0.04)	1.5	1	0.15	0.47	1000	-06	-07		80
FN2020A-10-..		10 (11.5)	0.07 (0.04)	2.9	0.8	0.15	0.47	1000	-06	-07		85
FN2020A-12-..		12 (13.8)	0.07 (0.04)	3.6	0.7	0.15	0.47	1000	-06	-07		85
FN2020A-16-..		16 (18.4)	0.07 (0.04)	2.5	0.65	0.15	0.47	1000	-06	-07	-08	140
FN2020A-20-..		20 (23)	0.07 (0.04)	3.8	0.6	0.15	0.47	1000	-06		-08	210
FN2020A-30-08		30 (34.5)	0.07 (0.04)	6.3	0.67	0.47	0.47	470			-08	470
FN2020A-60-24		60 (69)	0.07 (0.04)	14.7	1	1.5	0.47	220			-24	1100
FN2020B-1-..		1 (1.15)	0.00	0.8	12	0.15		1000	-06	-07		80
FN2020B-3-..		3 (3.45)	0.00	1.2	2.5	0.15		1000	-06	-07		80
FN2020B-6-..		6 (6.9)	0.00	1.5	1	0.15		1000	-06	-07		80
FN2020B-10-..		10 (11.5)	0.00	2.9	0.8	0.15		1000	-06	-07		85
FN2020B-12-..		12 (13.8)	0.00	3.6	0.7	0.15		1000	-06	-07		85
FN2020B-16-..		16 (18.4)	0.00	2.5	0.65	0.15		1000	-06	-07	-08	140
FN2020B-20-..		20 (23)	0.00	3.8	0.6	0.15		1000	-06		-08	210
FN2020B-30-08		30 (34.5)	0.00	6.3	0.67	0.47		470			-08	470
FN2020B-60-24		60 (69)	0.00	14.7	1	1.5		220			-24	1100

* To compile a complete part number, please replace the -.. with the required I/O connection style (e.g. FN 2020-30-08, FN 2020B-10-06).

** Maximum leakage under usual AC operating conditions (acc. IEC60939-3). Note: if the neutral line is interrupted, worst case leakage could reach twice this level.

*** Tolerances apply: Inductance: -30/+50%, Capacitance: ±20%, Resistance: ±10%

Typical Filter Attenuation

Per CISPR 17: symmetrical 50 Ω/50 Ω -> Differential Mode (DM); asymmetrical 50 Ω/50 Ω -> Common Mode (CM)

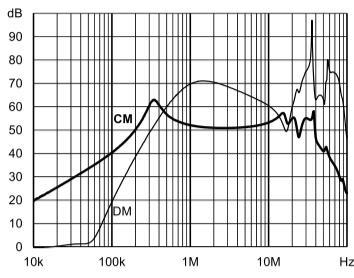

1 A: Standard type

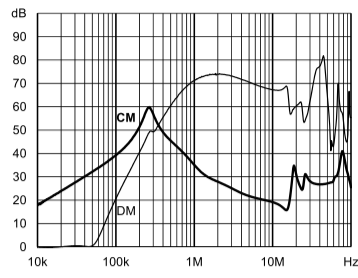

A type

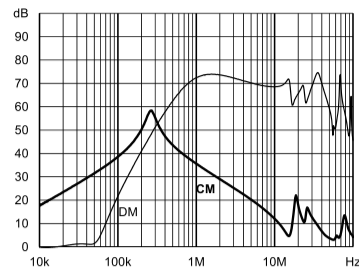

B type

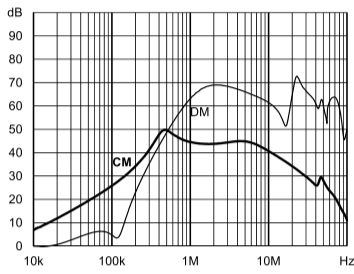

3 A: Standard type

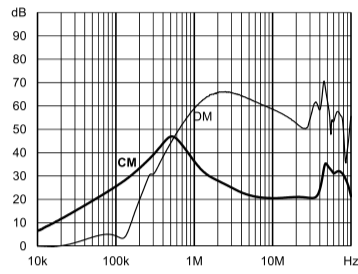

A type

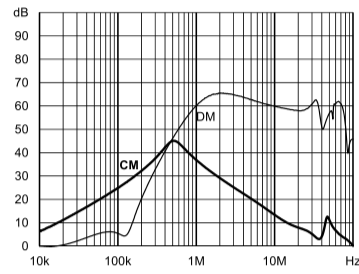

B type

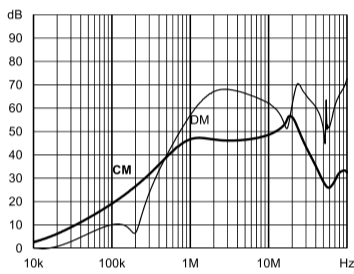

6 A: Standard type

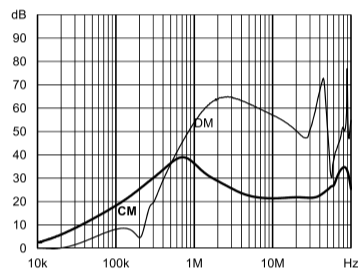

A type

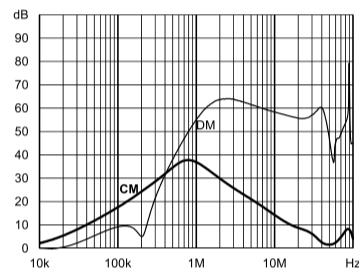

B type

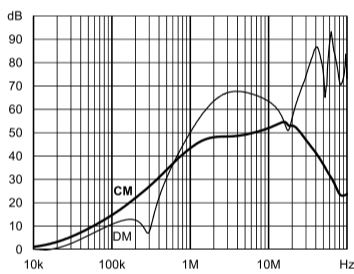

10 A: Standard type

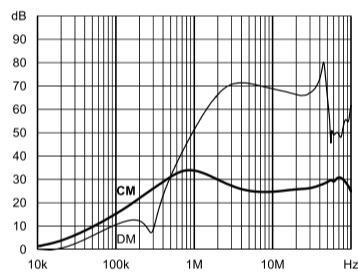

A type

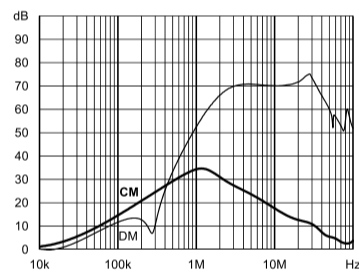

B type

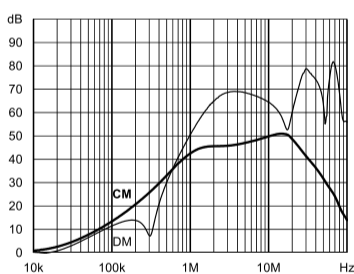

12 A: Standard type

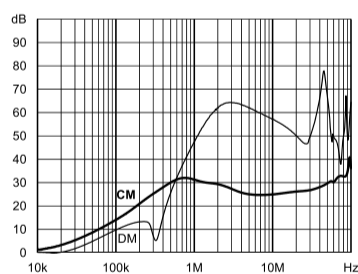

A type

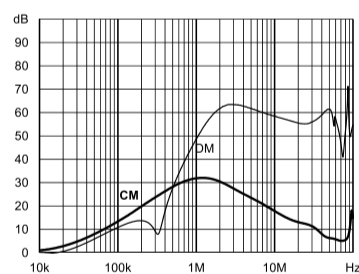

B type

Product selector		
	06	Faston 6.3 × 0.8 mm (spade/soldering)
	07	Wire leads
	08	Studs (M4 screws)
	24	Studs (M6 screws)
	1 to 60	Rated current
	Blank	Standard version
	A	Safety version
	B	Medical version

Mechanical Data

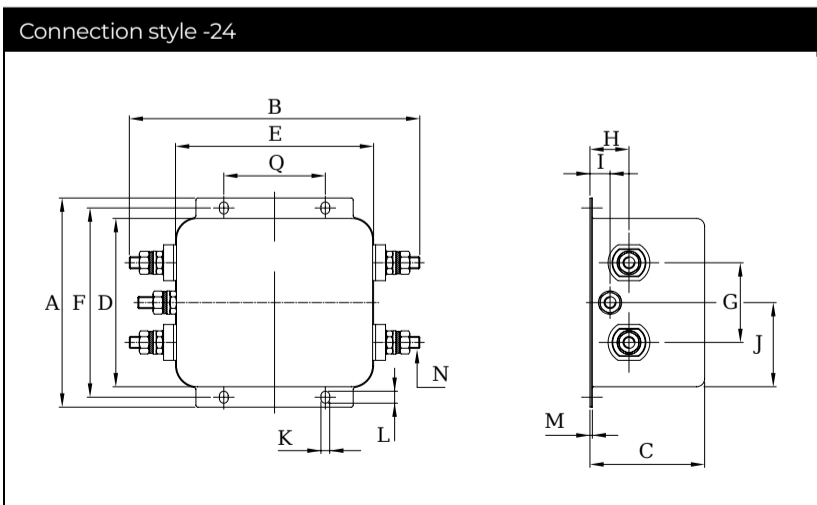
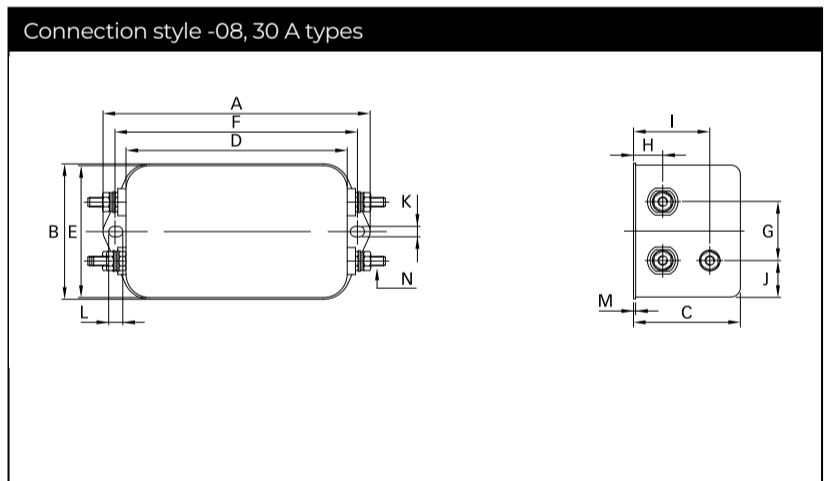
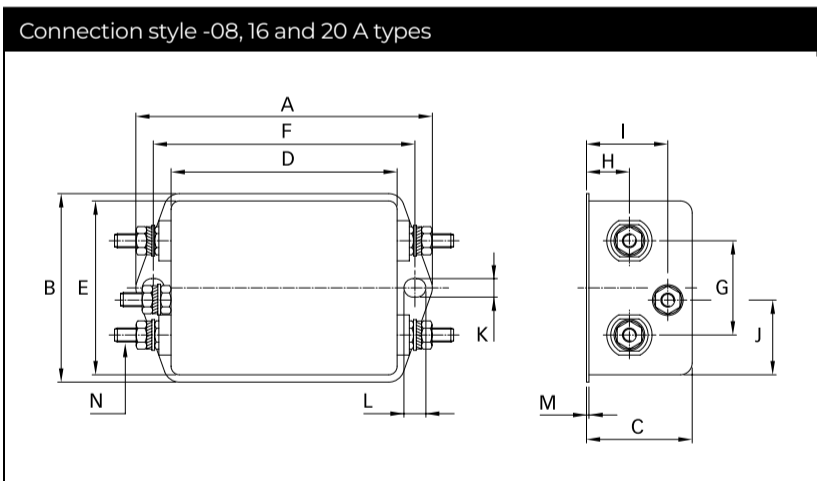
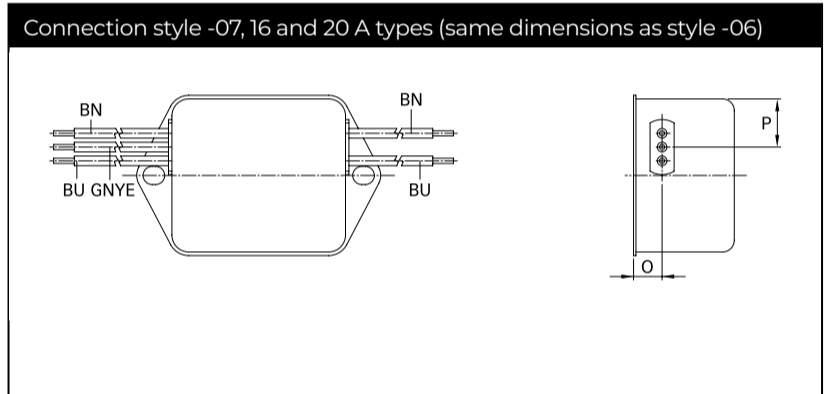
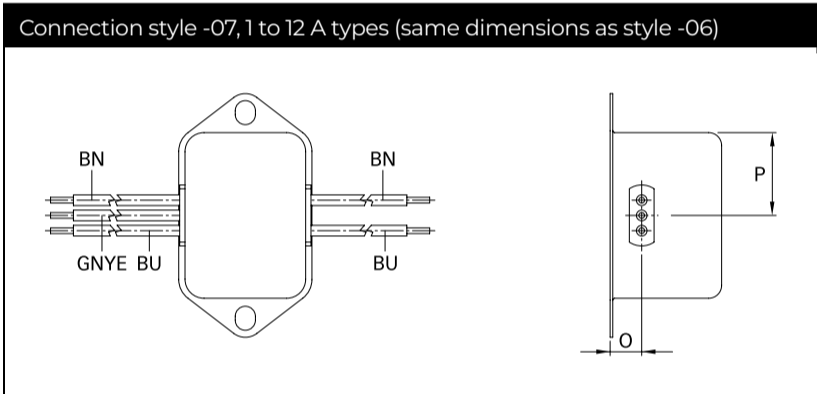
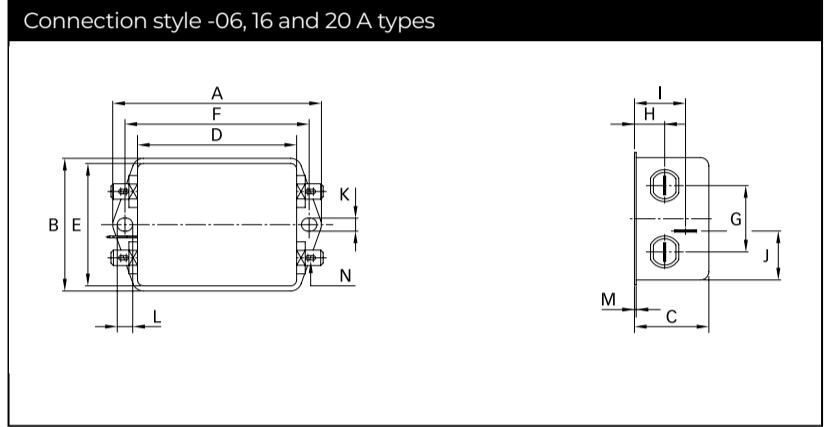
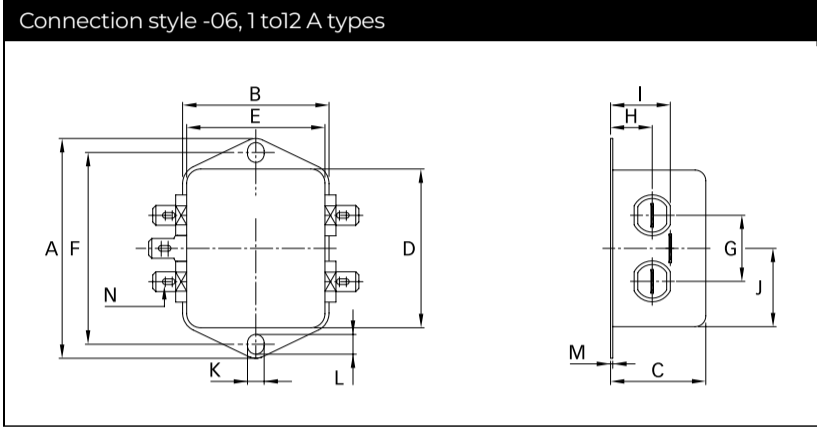

Dimensions

	1 A	3 A	6 A	10 A	12 A	16 A	20 A	30 A	60 A	Tolerances
A	64	64	64	64	64	71	85	113.5 ±1	105 ±1	±0.5
B	35	35	35	35	35	46.6	54	57.5 ±1	145.9 ±1	±0.5
C	29.3	29.3	29.3	29.3	29.3	29.3	30.3	45.4 ±1	57.6 ±1	±0.5
D	43.5	43.5	43.5	43.5	43.5	50.5	64.8	94 ±1	84.5 ±1	±0.5
E	32.5	32.5	32.5	32.5	32.5	44.5	49.8	56	99.5	±0.5
F	54	54	54	54	54	61	75	103	95	±0.3
G	21	21	21	21	21	21	27	25	40	±0.2
H	9.3	9.3	9.3	9.3	9.3	10.8	12.3	12.4	19.6	±0.5
I	15.3	15.3	15.3	15.3	15.3	19.3	20.8	32.4	10.1	±0.5
J	21.8	21.8	21.8	21.8	21.8	20.1	19.9	15.5	42.25	±0.5
K	5.3	5.3	5.3	5.3	5.3	5.3	5.3	4.4	4.4	
L	6.3	6.3	6.3	6.3	6.3	6.3	6.3	6	6	
M	0.7	0.7	0.7	0.7	0.7	0.7	0.7	1	1.2	±0.3
Connection style -06										
N	6.3 x 0.8	6.3 x 0.8	6.3 x 0.8	6.3 x 0.8	6.3 x 0.8	6.3 x 0.8	6.3 x 0.8			
Connection style -07										
O	8.3	8.3	8.3	8.3	8.3	8.3				±0.5
P	21.8	21.8	21.8	21.8	21.8	14				±0.5
AWG type wire	AWG 20	AWG 20	AWG 18	AWG 18	AWG 16	AWG 16				
Wire length	140	140	140	140	140	140				+5
Connection style -08										
N						M4	M4	M4		
Recommended torque (Nm)						1.2 - 1.3	1.2 - 1.3	1.2 - 1.3		
Earth Terminal						1.5 - 1.7	1.5 - 1.7	1.5 - 1.7		
Connection style -24										
N									M6	
Q									51	±0.2
Recommended torque (Nm)									3.5 - 4	
Earth Terminal									3.5 - 4	

All dimensions in mm; 1 inch = 25.4 mm

Tolerances according: ISO 2768-m/EN 22768-m

Please visit www.schaffner.com to find more details on filter connections.