

General Purpose AC/DC EMI Filter with High Attenuation Performance

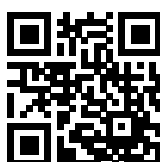

- Rated currents from 1 to 30 A
- High performance filter attenuation
- High differential-mode attenuation
- Optional medical versions (B type)
- Optional safety versions (A type)
- Optional enhanced performance versions
- Optional overvoltage protection (Z type)



Performance indicators

Attenuation performance



Rated current [A]

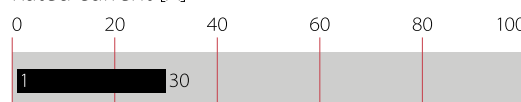

Approvals & Compliances



Features and Benefits

- FN 2030 filters are designed for easy and fast chassis mounting
- FN 2030 B versions without capacitors to earth comply to 1MOP for ME (medical equipment) acc. IEC 60601-1
- FN 2030 A versions with low capacitance to earth for safety critical applications with a requirement for low leakage currents
- FN 2030 filters offer an optimized filter range for high performance AC and DC applications, in same compact size (M, N1 types)
- All filters provide an exceptional conducted attenuation performance, based on chokes with high permeable core material and excellent thermal behavior
- The higher inductivity versus amperage offers increased attenuation performance with same form factor compared to FN 2010 and FN 2020 filter series
- All FN 2030 filters can be delivered with optional surge pulse protection (Z type).
- Various terminal options allow you to select the desired connection style

Technical Specifications

Rated voltage*	250 VAC, 50/60 Hz 250 VDC
Operating frequency	DC to 400 Hz
Surge pulse protection (Z type)	Helps compliance to IEC61000-4-5 (Differential Mode only)
High potential test voltage	P → N 1100 VDC for 2 sec P → PE 2000 VAC for 2 sec (equiv. cap <88 nF) P → PE 2550 VDC for 2 sec (equiv. cap >88 nF) P → PE 2500 VAC for 2 sec (B types)
Temperature range (operation and storage)	-25°C to +100°C (25/100/21)**
Certified to	UL 1283, CSA 22.2 No. 8 1986, IEC/EN 60939 (applies to AC and DC applications)
Flammability corresponding to	Laces for -07 version: UL 94 VW-1 Terminal plastic for -06/-08 version: UL 94 V-0 Grommet for -07 version: UL 94 V-0
Overvoltage category	II acc. IEC 60664-1
Pollution degree	2 acc. IEC 60664-1
Altitude	2000m (above derating applies)**
Rated currents	1 to 30 A @ 40°C max

* maximum RMS operating voltage at rated frequency or the maximum DC operating voltage
 ** for dedicated requests exceeding this specification (e.g. -40 °C or higher altitude) please contact your local Schaffner Sales office



Typical Applications

- Electrical and electronic equipment
- Consumer goods
- Household equipment
- Medical equipment
- Electronic data processing equipment
- Office automation and datacom equipment
- Various noisy applications requiring high filter performance

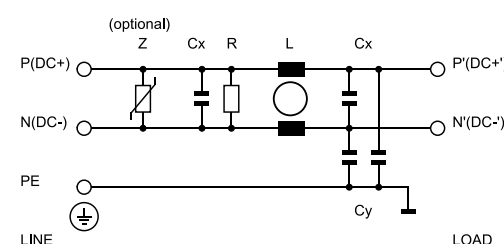
Typical electrical schematic



Filter Selection Table

Filter*	Buy	Rated current @ 40°C (25°C) [A]	Leakage current** @ 250 VAC/50 Hz (@ 120 VAC/60 Hz) [mA]	Power Loss @25°C/DC [W]	Inductance*** L [mH]	Capacitance***		Resistance*** R [kΩ]	Input/Output connections			Weight [g]
						Cx [μF]	Cy [nF]					
FN2030-1-..		1 (1.1)	0.31 (0.18)	0.9	20	0.22	2.2	1000	-06	-07		58
FN2030-3-..		3 (3.4)	0.47 (0.27)	2.2	14	0.33	3.3	1000	-06	-07		87
FN2030-4-..		4 (4.5)	0.47 (0.27)	2.9	14	0.33	3.3	1000	-06	-07		92
FN2030-6-..		6 (6.7)	0.66 (0.38)	3.2	8	0.47	4.7	680	-06	-07		100
FN2030-8-..		8 (8.9)	0.66 (0.38)	3.1	8	0.47	4.7	680	-06	-07		170
FN2030-10-..		10 (11.2)	0.66 (0.38)	5.3	8	0.47	4.7	680	-06	-07		196
FN2030-12-..		12 (13.4)	0.79 (0.45)	7.6	4	1.0	10	330	-06	-07		185
FN2030-16-..		16 (17.9)	0.79 (0.45)	6.1	4	1.0	10	330	-06	-07	-08	225
FN2030-20-..		20 (22.4)	0.79 (0.45)	4.6	4	1.0	10	330	-06		-08	285
FN2030-30-08		30 (33.5)	0.79 (0.45)	6.0	2	1.0	10	330			-08	326
Enhanced performance												
FN2030A-1-..		1 (1.1)	0.07 (0.04)	0.9	20	0.22	0.47	1000	-06	-07		58
FN2030A-3-..		3 (3.4)	0.07 (0.04)	2.2	14	0.33	0.47	1000	-06	-07		87
FN2030A-4-..		4 (4.5)	0.07 (0.04)	2.9	14	0.33	0.47	1000	-06	-07		92
FN2030A-6-..		6 (6.7)	0.07 (0.04)	3.2	8	0.47	0.47	680	-06	-07		100
FN2030A-8-..		8 (8.9)	0.07 (0.04)	3.1	8	0.47	0.47	680	-06	-07		170
FN2030A-10-..		10 (11.2)	0.07 (0.04)	5.3	8	0.47	0.47	680	-06	-07		196
FN2030A-12-..		12 (13.4)	0.07 (0.04)	7.6	4	1.0	0.47	330	-06	-07		185
FN2030A-16-..		16 (17.9)	0.07 (0.04)	6.1	4	1.0	0.47	330	-06	-07	-08	225
FN2030A-20-..		20 (22.4)	0.07 (0.04)	4.6	4	1.0	0.47	330	-06		-08	285
FN2030A-30-08		30 (33.5)	0.07 (0.04)	6.0	2	1.0	0.47	330			-08	326
FN2030B-1-..		1 (1.1)	0.00	0.9	20	0.22		1000	-06	-07		58
FN2030B-3-..		3 (3.4)	0.00	2.2	14	0.33		1000	-06	-07		87
FN2030B-4-..		4 (4.5)	0.00	2.9	14	0.33		1000	-06	-07		92
FN2030B-6-..		6 (6.7)	0.00	3.2	8	0.47		680	-06	-07		100
FN2030B-8-..		8 (8.9)	0.00	3.1	8	0.47		680	-06	-07		170
FN2030B-10-..		10 (11.2)	0.00	5.3	8.45	0.47		680	-06	-07		196
FN2030B-12-..		12 (13.4)	0.00	7.6	4	1.0		330	-06	-07		185
FN2030B-16-..		16 (17.9)	0.00	6.1	4	1.0		330	-06	-07	-08	225
FN2030B-20-..		20 (22.4)	0.00	4.6	4	1.0		330	-06		-08	285
FN2030B-30-08		30 (33.5)	0.00	6.0	2	1.0		330			-08	326
FN2030N1-06		1 (1.1)	5.34 (3.08)	0.9	20	0.22	68	1000	-06			65
FN2030M-3-06		3 (3.4)	3.69 (2.28)	2.2	14	0.33	47	1000	-06			110
FN2030M-4-06		4 (4.5)	3.69 (2.28)	2.9	14	0.33	47	1000	-06			110
FN2030M-6-06		6 (6.7)	3.69 (2.28)	3.2	8	0.47	47	680	-06			120
FN2030N1-8-06		8 (8.9)	5.34 (3.08)	3.1	8	0.47	68	3680	-06			200
FN2030N1-10-06		10 (11.2)	5.34 (3.08)	5.3	8	0.47	68	680	-06			200
FN2030N1-12-06		12 (13.4)	5.34 (3.08)	7.6	4	1.0	68	330	-06			210
FN2030M-16-..		16 (17.9)	3.69 (2.28)	6.1	4	1.0	47	330	-06		-08	265
FN2030M-20-..		20 (22.4)	3.69 (2.28)	4.6	4	1.0	47	330	-06		-08	326
FN2030M-30-08		30 (33.5)	3.69 (2.28)	6.0	2	1.0	47	330			-08	346

* To compile a complete part number, please replace the .. with the required I/O connection style. For surge pulse protection, please add Z (e.g. FN 2030Z-10-06, FN 2030BZ-20-08).

** Maximum leakage under usual AC operating conditions (acc. IEC60939-3). Note: if the neutral line is interrupted, worst case leakage could reach twice this level.

*** Tolerances apply: Inductance: -30/+50%, Capacitance: ±20%, Resistance: ±10%

Typical Filter Attenuation

Per CISPR 17: symmetrical 50 Ω/50 Ω -> Differential Mode (DM); asymmetrical 50 Ω/50 Ω -> Common Mode (CM)

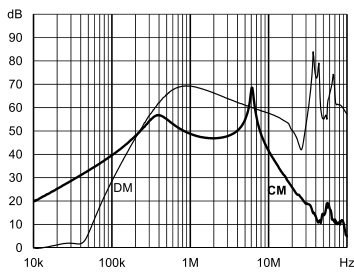

1 A: Standard type

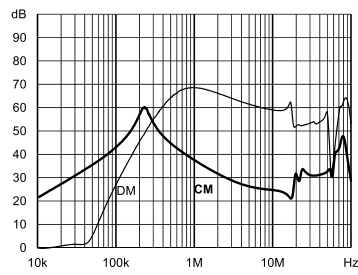

A type

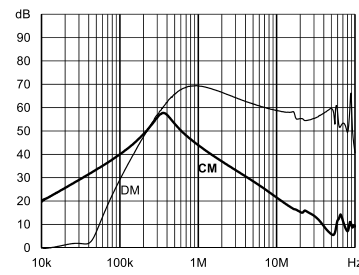

B type

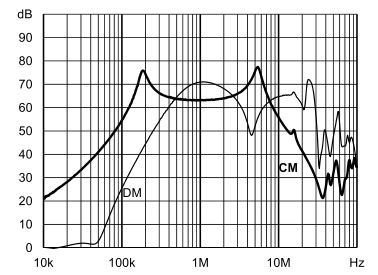

Enhanced performance

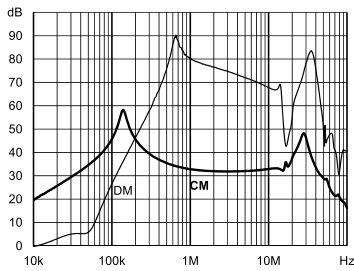

3 A: Standard type

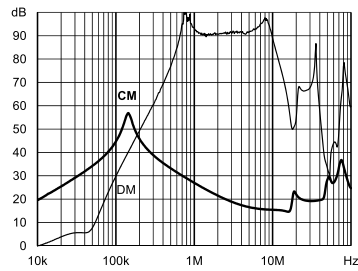

A type

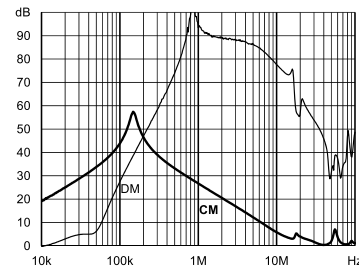

B type

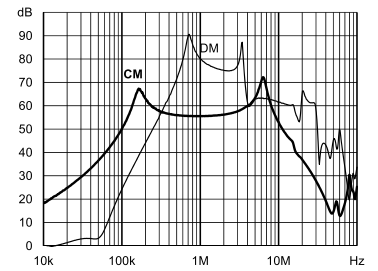

Enhanced performance

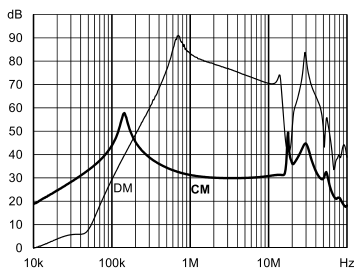

4 A: Standard type

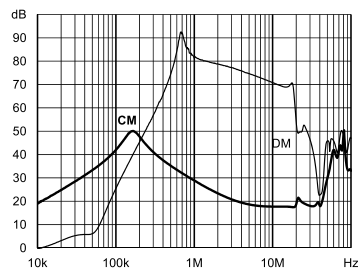

A type

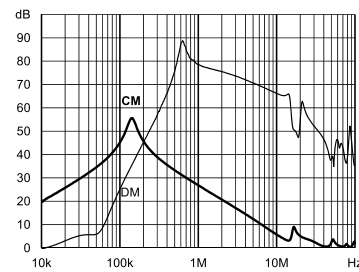

B type

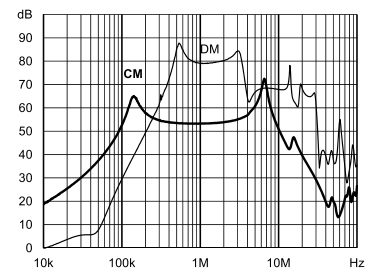

Enhanced performance

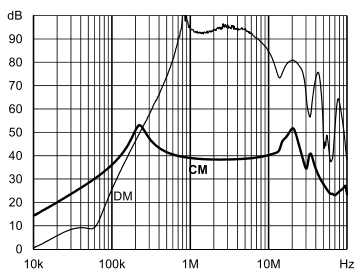

6 A: Standard type

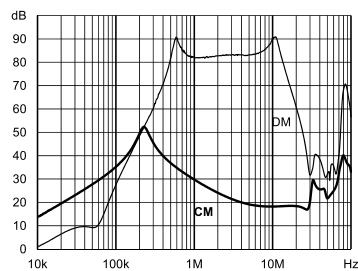

A type

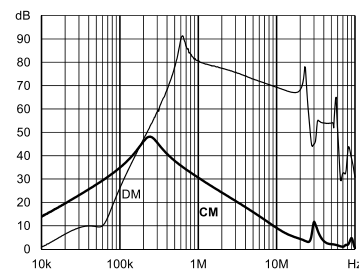

B type

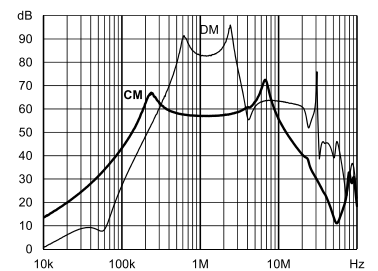

Enhanced performance

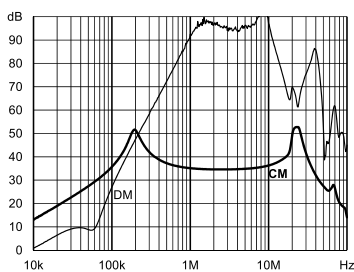

8 A: Standard type

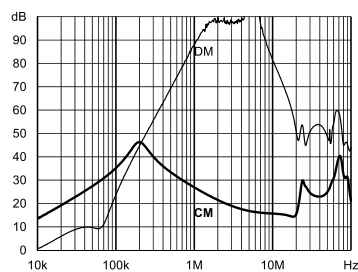

A type

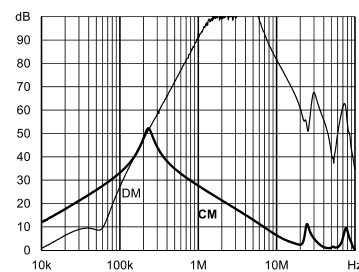

B type

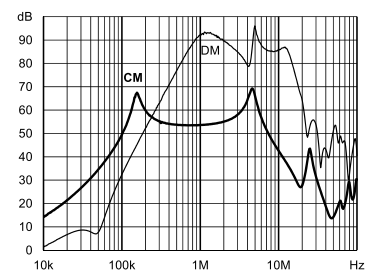

Enhanced performance

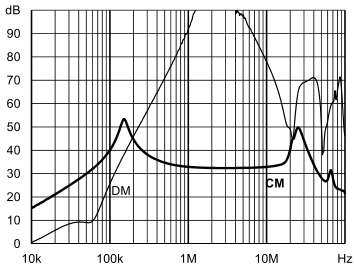

10 A: Standard type

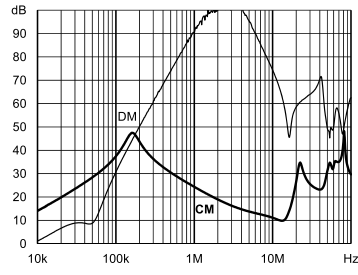

A type

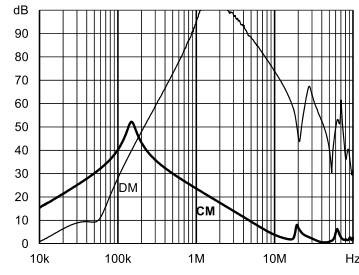

B type

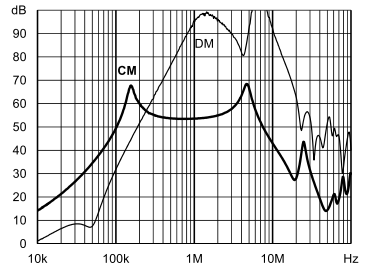

Enhanced performance

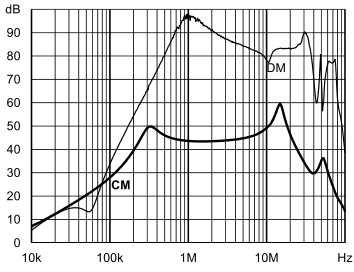

12 A: Standard type

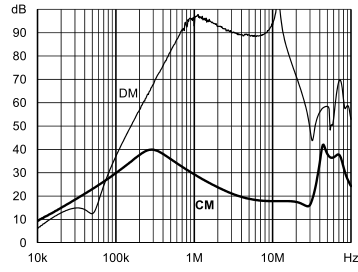

A type

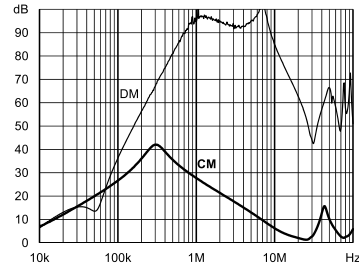

B type

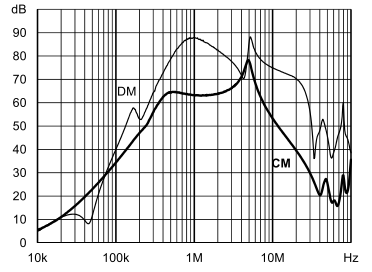

Enhanced performance

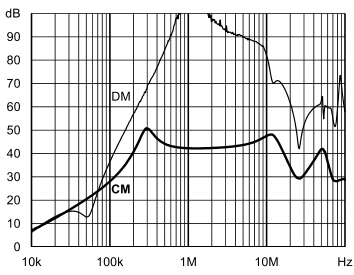

16 A: Standard type

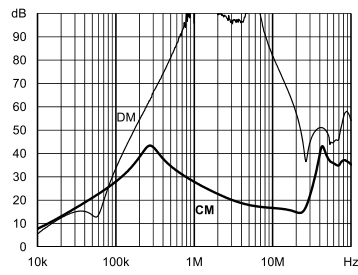

A type

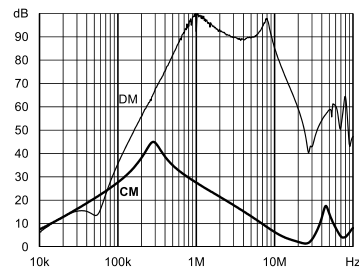

B type

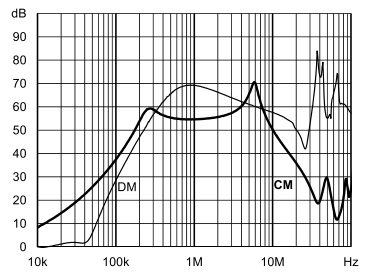

Enhanced performance

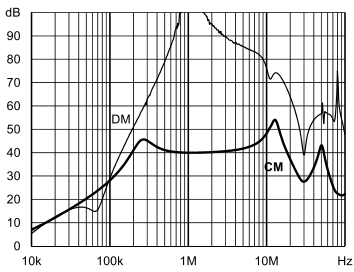

20 A: Standard type

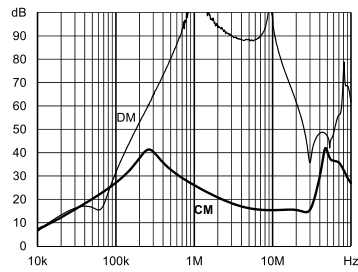

A type

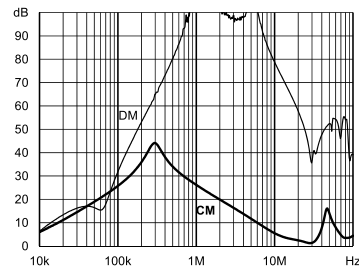

B type

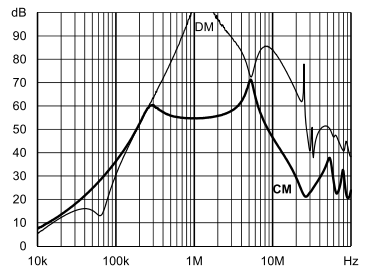

Enhanced performance

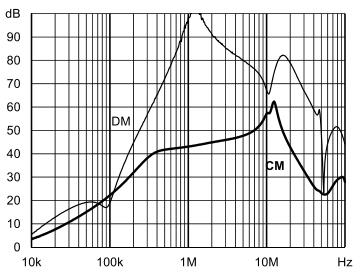

30 A: Standard type

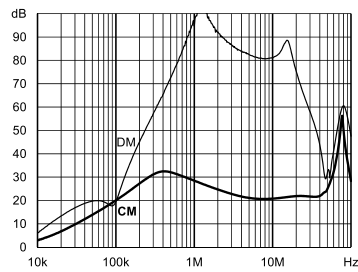

A type

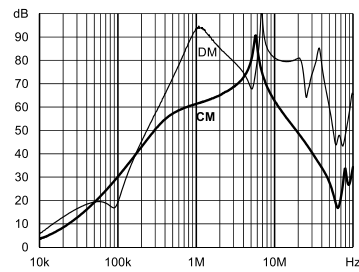

B type

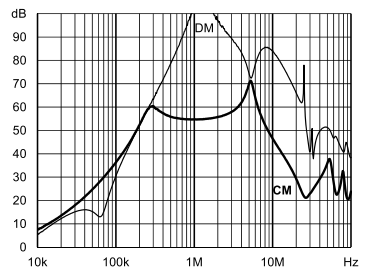

Enhanced performance

Product Selector

FN 2030 xy-xx-yy

06	Faston 6.3 × 0.8 mm (spade/soldering)
07	Wire leads
08	Studs (M4 screws)
1 to 60	Rated current
Blank	Standard version
Z	With surge protection
Blank	Standard version
A	Safety version
B	Medical version
N1/M	High performance version

Mechanical data

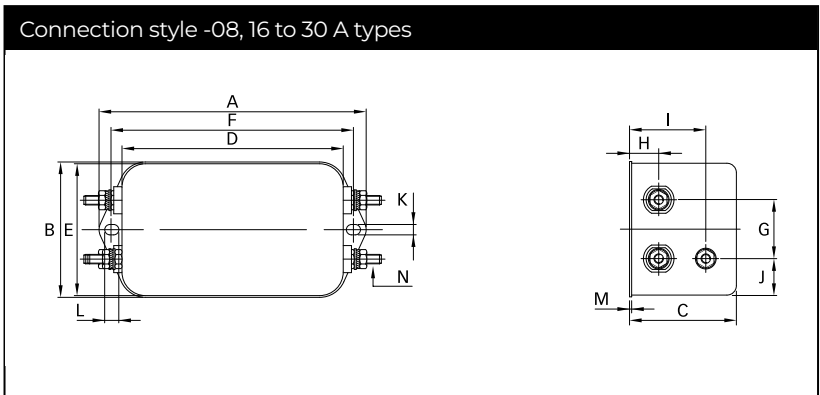
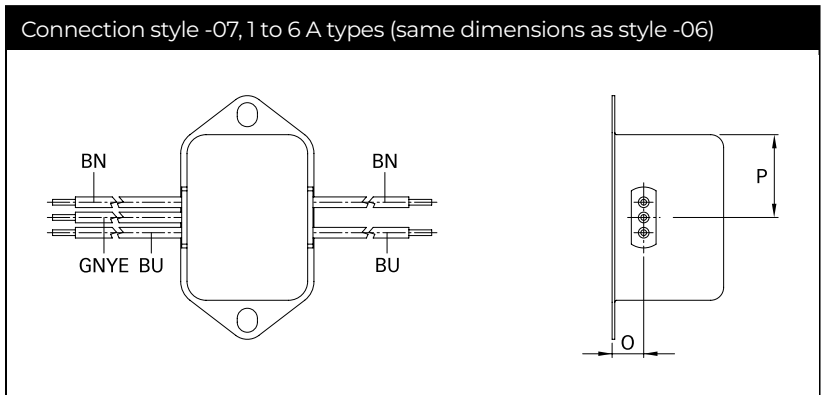
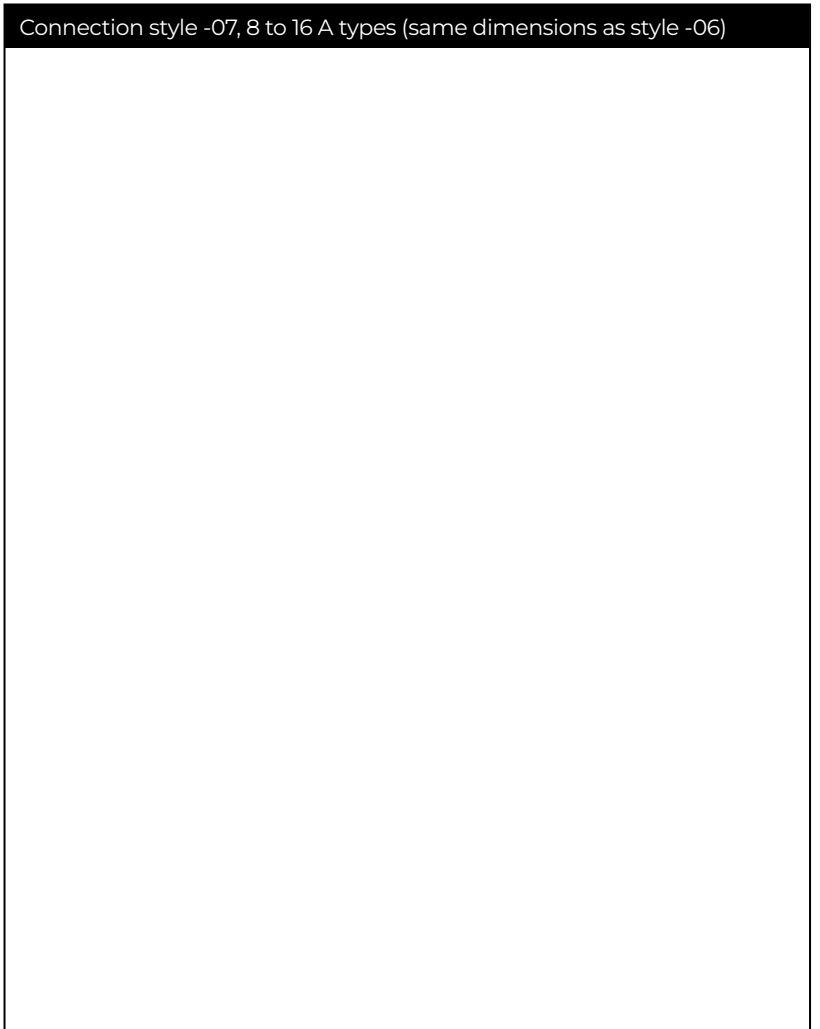
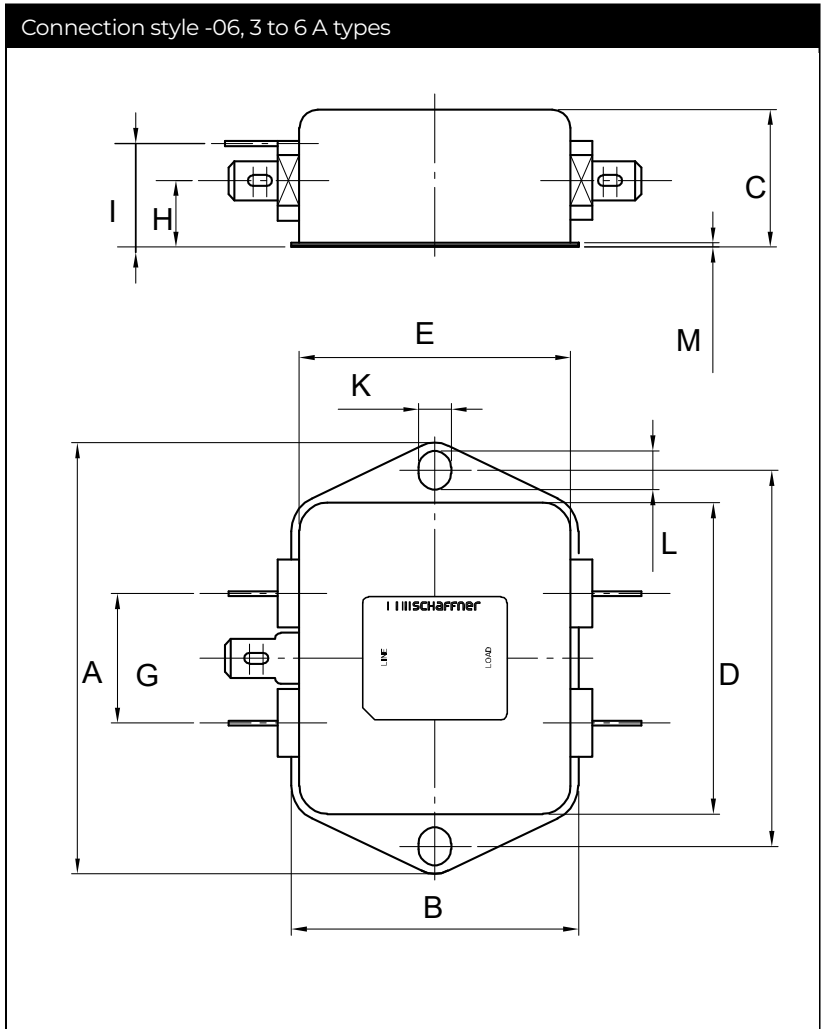
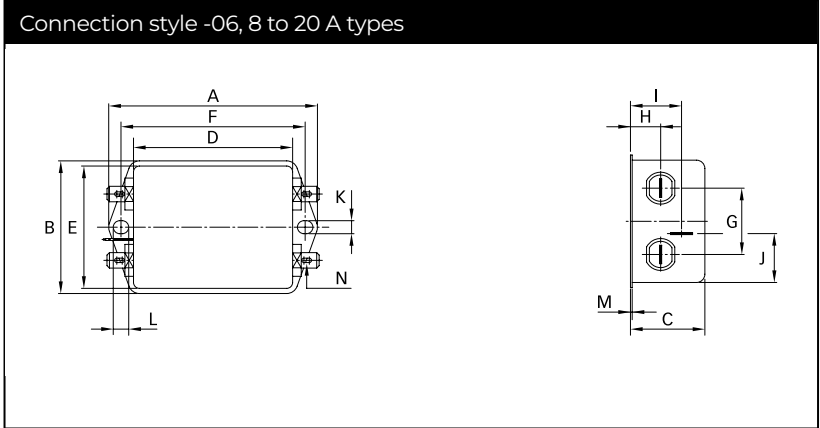
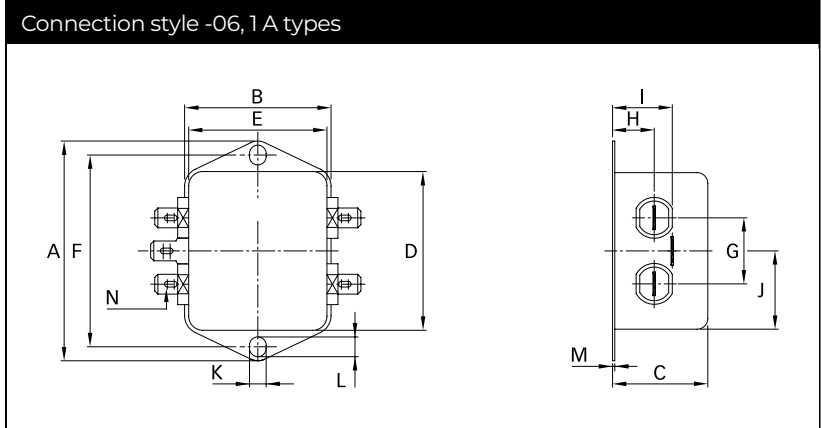

Dimensions

	1 A	3 A	4 A	6 A	8 A	10 A	12 A	16 A	20 A	30 A	Tolerances
A	64	71	71	71	85	85	85	85	85	85	±0.5
B	35	46.6	46.6	46.6	54	54	54	54	54	54	±0.5
C	24.3	22.3	22.3	22.3	30.3	30.3	30.3	40.3	40.3	40.3	±0.5
D	43.5	50.5	50.5	50.5	64.8	64.8	64.8	64.8	64.8	64.8	±0.5
E	32.5	44.5	44.5	44.5	49.8	49.8	49.8	49.8	49.8	49.8	±0.5
F	54	61	61	61	75	75	75	75	75	75	±0.3
G	21	21	21	21	27	27	27	27	27	27	±0.2
H	9.3	10.8	10.8	10.8	12.3	12.3	12.3	12.3	12.3	12.3	±0.5
I	15.3	16.8	16.8	16.8	20.8	20.8	20.8	29.8	29.8	29.8	±0.5
J	21.8	25.25	25.25	25.25	19.9	19.9	19.9	11.4	11.4	11.4	±0.5
K	5.3	5.3	5.3	5.3	5.3	5.3	5.3	5.3	5.3	5.3	
L	6.3	6.3	6.3	6.3	6.3	6.3	6.3	6.3	6.3	6.3	
M	0.7	0.7	0.7	0.7	0.7	0.7	0.7	0.7	0.7	0.7	
Connection style -06											
N	6.3 x 0.8	6.3 x 0.8	6.3 x 0.8	6.3 x 0.8	6.3 x 0.8	6.3 x 0.8	6.3 x 0.8	6.3 x 0.8	6.3 x 0.8	6.3 x 0.8	
Connection style -07											
O	8.3	8.3	8.3	8.3	8.3	8.3	8.3	8.3			±0.5
P	21.8	14	14	14	14.9	14.9	14.9	14.9			±0.5
AWG type wire	AWG 20	AWG 20	AWG 20	AWG 18	AWG 18	AWG 18	AWG 16	AWG 16			
Wire length	140	140	140	140	140	140	140	140			+5
Connection style -08											
N								M4	M4	M4	
Recommended torque (Nm)								1.2 - 1.3	1.2 - 1.3	1.2 - 1.3	
Earth terminal								1.5 - 1.7	1.5 - 1.7	1.5 - 1.7	

All dimensions in mm; 1 inch = 25.4 mm

Tolerances according: ISO 2768-m/EN 22768-m