

# Smallest book-style EMC/RFI Filter for Inverter and Power Drive Systems

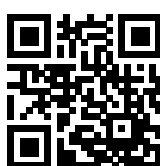

- Standard and high performance EMC solution
- Footprint space-saving book-style housing
- Solid safety connector blocks
- Standard attenuation performance FN3287
- High attenuation performance FN3288
- HV versions for 690 VAC applications
- HVIT- and IT versions for IT distribution networks
- Versions with low leakage current



### Performance indicators

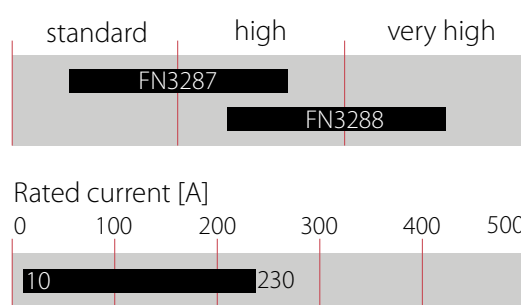

### Approvals & Compliances



600 VAC

### Features and Benefits

- The FN3287 and FN3288 filter series provides state-of-the-art EMI attenuation based on an innovative filter topology. They help to ensure compliance with Class C2 or even C1 limits.
- The slim book-style shape allows a convenient and space-saving installation next to inverters, converters or motor drives.
- The compact FN3287 and FN3288 filter from 10 to 230A are designed for the most diverse applications worldwide, including machinery and machine tools.
- FN3288HV filters up to 230 A are applicable for 690 VAC distribution networks.
- FN 3288IT and FN 3288HVIT filters up to 230 A meet the special requirements for IT distribution networks.
- Low leakage current filter versions help to fulfill tough requirements (e.g. 0.1 mA) in respect of leakage current limitation.

## Technical Specifications

<b>Maximum continuous operating voltage</b>	3x 530/305 VAC (FN 3287, FN 3288) 3x 530 VAC (FN 3288 IT) 3x 760/440 VAC (FN 3288 HV) 3x 760 VAC (FN 3288 HVIT)
<b>Rated currents</b>	10 to 230 A @50°C
<b>Operating frequency</b>	DC to 60 Hz
<b>High potential test voltage</b>	P -> E 2260 VDC for 2 s (FN 3287, FN 3288) P -> E 2900 VDC for 2 s (FN 3288 IT) P -> P 2280 VDC for 2 s (FN 3287, FN 3288, FN 3288 IT) P -> E 2650 VDC for 2 s (FN 3288 HV) P -> E 3530 VDC for 2 s (FN 3288 HVIT) P -> P 3270 VDC for 2 s (FN 3288 HV)
<b>Pollution degree</b>	3 acc. IEC 60664-1
<b>Overload capability</b>	6x rated current for 1 sec, once per hour 1.5x rated current for 1 minute, once per hour
<b>Temperature range (operation and storage)</b>	-40°C to +100°C (with current derating >50°C)
<b>Climatic class</b>	40/100/21 acc. to IEC 60068-1
<b>Protection category</b>	IP 20 acc. to IEC 60529
<b>Vibration and shock</b>	3M4 (operation); 2M2 (transport) acc. to IEC 60721-3-3; IEC 60721-3-2
<b>Flammability according to</b>	UL 94 V-0
<b>Compliance with insulation requirement</b>	> 1MΩ acc. to IEC 60204-1
<b>Design corresponding to</b>	UL 60939-3, IEC 60939-3
<b>MTBF</b>	> 200,000 hours
<b>SCCR*</b>	100kA acc. to UL508 - high fault current
<b>Overvoltage category</b>	III acc. IEC 60664-1

### Typical Applications

- Three-phase variable speed drives and power drive systems (PDS)
- Machine tool and machinery equipment
- IT power distribution networks (FN3288IT and FN3288 HVIT)
- General energy conversion devices (inverters, converters)
- Process automation equipment
- Three-phase power supplies
- Low-leakage current requirements



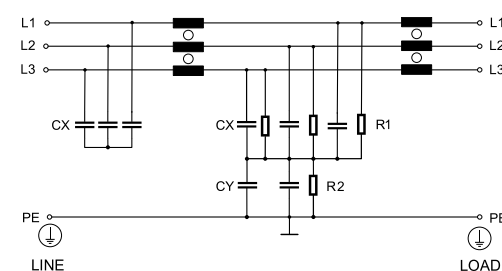

































### Typical electrical schematic



Note: IT and HVIT versions without discharge resistor to ground.

\* SCCR (High Fault Current acc UL508): 100kA, with overcurrent protection of J-Type current limiting fuses. Fuse rating shall not exceed 150% of filter current rating.

## Filter Selection Table

Filter	Buy	Rated current @ 50°C (40°C) [A]	Typical drive Power rating** [kW]	Leakage current***									Power loss @ 25°C [W]	Terminal Type	Weight [kg]	Frame	
				@ 530 VAC/50 Hz [mA]													
				C35	C34	C33	C28	C27	C26	C21	C17	C13					
<b>Capacitor option *C..</b>																	
<b>Standard performance:</b>																	
FN3287-10-44-C..-R65		10 (11)	6				3.7			2.2	0.4			7.5	-44	0.7	Q
FN3287-16-44-C..-R65		16 (17)	9			4.3				2.4	0.4			9.5	-44	0.8	R
FN3287-20-33-C..-R65		20 (22)	12			4.9				2.5	0.4			10.0	-33	0.9	S
FN3287-25-33-C..-R65		25 (27)	15			4.9				2.5	0.4			11.4	-33	1.0	S
FN3287-40-33-C..-R65		40 (44)	24			4.9				2.5	0.4			22.6	-33	1.5	T
FN3287-50-53-C..-R65		50 (55)	29			4.9				2.5	0.4			25.5	-53	2.1	U
FN3287-63-53-C..-R65		63 (69)	38			4.9				2.5	0.4			32.1	-53	2.2	U
FN3287-80-34-C..-R65		80 (88)	47			5.6				2.7	0.4			32.6	-34	3.4	F
FN3287-100-35-C..-R65		100 (110)	59			5.6				2.7	0.4			33.0	-35	4.2	G
FN3287-125-35-C..-R65		125 (137)	74			5.6				2.7	0.4			37.5	-35	4.6	G
FN3287-160-40-C..-R65		160 (175)	94			5.6				2.7	0.4			38.4	-40	6.0	H
FN3287-230-40-C..-R65		230 (230)	135			5.9				2.7	0.4			47.6	-40	8.8	V
<b>High performance:</b>																	
FN3288-10-44-C..-R65		10 (11)	6		5.9					2.5	0.4	0.1		7.1	-44	0.8	A
FN3288-16-44-C..-R65		16 (17)	9	6.0						2.5	0.4	0.1		10.5	-44	1.0	B
FN3288-20-33-C..-R65		20 (22)	12	6.0						2.5	0.4	0.1		10.7	-33	1.2	C
FN3288-25-33-C..-R65		25 (27)	15	6.0						2.5	0.4	0.1		17.8	-33	1.2	C
FN3288-40-33-C..-R65		40 (44)	24	6.0				3.5		0.4	0.1			21.6	-33	1.8	D
FN3288-50-53-C..-R65		50 (55)	29	6.6						2.6	0.4	0.1		29.3	-53	2.5	E
FN3288-63-53-C..-R65		63 (69)	38	6.6						2.6	0.4	0.1		34.5	-53	2.7	E
FN3288-80-34-C..-R65		80 (88)	47	7.1						2.7	0.4	0.1		28.8	-34	4.3	F
FN3288-100-35-C..-R65		100 (110)	59	7.1						2.7	0.4	0.1		36.0	-35	5.1	G
FN3288-125-35-C..-R65		125 (137)	74	7.1						2.7	0.4	0.1		42.2	-35	5.0	G
FN3288-160-40-C..-R65		160 (175)	94	7.1						2.7	0.4	0.1		46.1	-40	6.6	H
FN3288-230-40-C..-R65		230 (230)	135	7.5						2.7	0.4	0.1		47.6	-40	9.3	V
<b>HP for IT power networks****:</b>																	
FN3288IT-10-44-C..-R60		10 (11)	11		5.9									6.2	-44	1.1	I
FN3288IT-16-44-C..-R60		16 (17)	17		5.9									9.7	-44	1.3	J
FN3288IT-20-33-C..-R60		20 (22)	22		5.9									13.2	-33	1.6	K
FN3288IT-25-33-C..-R60		25 (27)	27		5.9									15.6	-33	1.6	K
FN3288IT-40-33-C..-R60		40 (44)	45		5.9									18.7	-33	2.8	L
FN3288IT-50-53-C..-R60		50 (55)	56		6.5									24.0	-53	2.8	M
FN3288IT-63-53-C..-R60		63 (69)	70		6.5									29.8	-53	2.9	M
FN3288IT-80-34-C..-R60		80 (88)	89		7.0									28.8	-34	4.6	N
FN3288IT-100-35-C..-R60		100 (110)	112		7.0									33.0	-35	5.4	O
FN3288IT-125-35-C..-R60		125 (137)	139		7.0									42.2	-35	5.3	O
FN3288IT-160-40-C..-R60		160 (175)	178		7.0									46.1	-40	6.9	P
FN3288IT-230-40-C..-R60		230 (230)	135		7.0							0.02		47.6	-40	9.3	V

\* Replace C.. with corresponding listed C35, C34, C33, C28, C27, C26, C21, C17 or C13.

\*\* Typical power rating at 400 VAC for FN3287 and FN3288 with  $\cos \phi = 0.85$ . The exact value depends upon the efficiency of the drive, the motor and the entire application.

\*\*\* Standardized calculated leakage current acc. IEC 60939 under normal operating conditions (FN3287, FN3288 and FN3288 IT at 530 VAC).

\*\*\*\* These filters may be operated in IT system as long as the operation conditions and possible short circuit/fault (earth connection of one conductor) occurs between the supply (line side) and the filter. The filters are not designed for short circuit/faults occurring between converter and motor.

### Filter Selection Table

Filter	Buy	Rated current @ 50°C (40°C) [A]	Typical drive Power rating** [kW]	Leakage current*** @ 760 VAC/50 Hz [mA]								Power loss @ 25°C [W]	Terminal Type	Weight [kg]	Frame
				C44	C43	C42	C36	C34	C26	C25	C24				
<b>Capacitor option * C..</b>															
<b>High voltage versions:</b>															
FN3288HV-10-44-C..-R65	🛒	10 (11)	10					8.4			1.8	7.0	-44	1.2	I
FN3288HV-16-44-C..-R65	🛒	16 (17)	13					8.4		2.5		10.8	-44	1.5	J
FN3288HV-20-33-C..-R65	🛒	20 (22)	17				10.9			2.5		12.6	-33	1.8	K
FN3288HV-25-33-C..-R65	🛒	25 (27)	21				10.9			2.5		14.6	-33	1.9	K
FN3288HV-40-33-C..-R65	🛒	40 (44)	35				12.4			2.6		19.2	-33	2.9	L
FN3288HV-50-53-C..-R65	🛒	50 (55)	43				12.4			2.6		26.3	-53	3.3	M
FN3288HV-63-53-C..-R65	🛒	63 (69)	55				12.4			2.6		33.3	-53	3.5	M
FN3288HV-80-34-C..-R65	🛒	80 (88)	70				12.4			2.6		28.8	-34	4.9	N
FN3288HV-100-35-C..-R65	🛒	100 (110)	100				12.4			2.6		33.0	-35	5.8	O
FN3288HV-125-35-C..-R65	🛒	125 (137)	110				12.4			2.6		42.0	-35	5.9	O
FN3288HV-160-40-C..-R65	🛒	160 (175)	140				12.4			2.6		46.1	-40	7.2	P
FN3288HV-230-40-C..-R65	🛒	230 (230)	200				12.4			2.6	0.1	47.6	-40	9.3	V
<b>HV for IT power networks****:</b>															
FN3288HVIT-10-44-C..-R60	🛒	10 (11)	10		4.6					3.6		7.0	-44	1.2	I
FN3288HVIT-16-44-C..-R60	🛒	16 (17)	13		6.8					3.7		10.8	-44	1.5	J
FN3288HVIT-20-33-C..-R60	🛒	20 (22)	17		6.8					3.7		12.6	-33	1.8	K
FN3288HVIT-25-33-C..-R60	🛒	25 (27)	21		6.8					3.7		14.6	-33	1.9	K
FN3288HVIT-40-33-C..-R60	🛒	40 (44)	35		6.8					3.7		19.2	-33	2.9	L
FN3288HVIT-50-53-C..-R60	🛒	50 (55)	43		6.8					3.7		26.3	-53	3.3	M
FN3288HVIT-63-53-C..-R60	🛒	63 (69)	55		6.8					3.7		33.3	-53	3.5	M
FN3288HVIT-80-34-C..-R60	🛒	80 (88)	70		6.8					3.7		28.8	-34	4.9	N
FN3288HVIT-100-35-C..-R60	🛒	100 (110)	100		6.8					3.7		33.0	-35	5.8	O
FN3288HVIT-125-35-C..-R60	🛒	125 (137)	110	5.9						3.7		42.2	-35	5.9	O
FN3288HVIT-160-40-C..-R60	🛒	160 (175)	140		6.8					3.7		46.1	-40	7.2	P
FN3288HVIT-230-40-C..-R60	🛒	230 (230)	200					12.4	3.7			47.1	-40	9.3	V

\* Replace C.. with corresponding listed C44, C43, C42, C36, C34, C26, C25, C24 or C17.

\*\* Typical power rating (400 VAC for FN3287 and FN3288 / 690 VAC for FN3288 HV and FN3288 HVIT) with cos phi=0.85. The exact value depends upon the efficiency of the drive, the motor and the entire application.

\*\*\* Standardized calculated leakage current acc. IEC 60939 under normal operating conditions (FN3288 HV and FN3288 HVIT at 760 VAC).

\*\*\*\*These filters may be operated in IT system as long as the operation conditions and possible short circuit/fault (earth connection of one conductor) occurs between the supply (line side) and the filter. The filters are not designed for short circuit/faults occurring between converter and motor.

### Distribution Inventory

Up-to-date inventory levels for global distributors is available at

<https://products.schaffner.com/stock>









## Mechanical Data

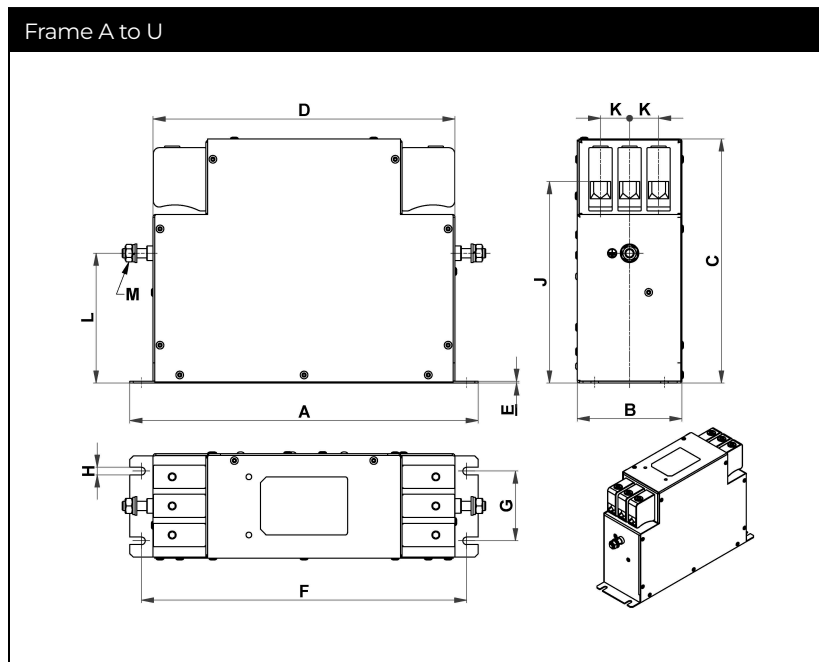

## Dimensions\*

Frame	A	B	C	D	E	F	G	H	J+/-2	K	L+/-1	M**
A	185	40	120	157	0.8	175	20	4.5	102	11	76	M5
B	195	45	140	164	0.8	180	25	5.4	122	11	93	M5
C	210	45	145	174	0.8	195	25	5.4	126	13	96	M5
D	235	50	168	207	1.0	220	30	5.4	149	13	115	M6
E	255	65	180	226	1.0	240	45	5.4	156	16	120	M6
F	290	80	205	250	1.2	270	50	6.5	172	22	110	M6
G	300	90	210	260	1.5	280	60	6.5	173	25	112	M8
H	310	100	225	270	1.5	290	70	6.5	183	28	110	M10
I	230	50	132	203	0.8	220	30	4.5	114	12.5	88	M5
J	230	55	159	198	0.8	215	35	5.4	141	13	112	M5
K	245	55	167	212	0.8	230	35	5.4	148	13	118	M5
L	265	60	191	237	1.0	250	40	5.4	172	13	135	M6
M	265	70	194	237	1.0	250	50	5.4	170	16	133	M6
N	310	95	220	270	1.2	290	65	6.5	187	22	125	M6
O	320	95	230	280	1.5	300	65	6.5	192	25	127	M8
P	330	100	240	290	1.5	310	70	6.5	198	30	127	M10
Q	180	40	112	153	0.8	170	20	4.5	94	11	68	M5
R	200	45	120	170	0.8	185	25	5.4	102	11	76	M5
S	205	45	132	173	0.8	190	25	5.4	113	13	83	M5
T	215	50	147	185	1.0	200	30	5.4	128	13	95	M6
U	220	65	180	186	1.0	205	45	5.4	156	16	120	M6
V	350	105	240	310	1.5	330	70	6.5	190	30.5	125	M10

\* All dimensions in mm. For dimensions without stated tolerances: ISO 2768-m/EN 22768-m

\*\* Earth screw torque: M5 2.0-2.2 Nm; M6 3.5-4.0 Nm; M8 8.0-9.0 Nm; M10 15-17 Nm

## Filter Input/Output Connector Cross Sections

	-44	-33	-53	-34	-35	-40
<b>Solid wire</b>	0.5-10 mm <sup>2</sup>	0.5-16 mm <sup>2</sup>	0.5-16 mm <sup>2</sup>	6-35 mm <sup>2</sup>	10-50 mm <sup>2</sup>	25-95 mm <sup>2</sup>
<b>Flex wire</b>	0.5-6 mm <sup>2</sup>	0.5-10 mm <sup>2</sup>	0.5-16 mm <sup>2</sup>	6-25 mm <sup>2</sup>	16-50 mm <sup>2</sup>	25-95 mm <sup>2</sup>
<b>Flex wire AWG</b>	AWG 20-8	AWG 22-6	AWG 20-4	AWG 6-2	AWG 6-1/0	AWG 0-4/0
<b>Recommended torque</b>	1.0-1.2 Nm	1.5-1.8 Nm	2.0-2.3 Nm	4.0-4.5 Nm	7.0-8.0 Nm	17-20 Nm

Please visit [www.schaffner.com](http://www.schaffner.com) to find more details on filter connectors.

## Accessories

### Surge Protection Devices



SPD with a fail safe function to prevent short-circuit (separation of circuit and element is visually confirmable)

Compliance with IEC 61643-1 that meets the new JIS standards

Against indirect lightning surge for single phase / three phase power supplies Quick response for surge

Impulse current capacity 8/20 $\mu$ s-5,000A

Impulse test category: Class II (Type II)

Every pathway consists of same elements. Between line and line/between lines and ground can protect as the same level.

[Technical Data Sheet >](#)