

Versatile Filtered Power Entry Module

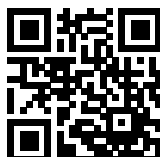

- Rated currents up to 6 A
- Single or dual-fuse holder
- Fuses Ø6.3 x 32 mm or Ø5 x 20 mm
- Voltage selector 100/120/230/240 V
- General purpose application
- Optional medical versions (B type)



Performance indicators

Attenuation performance



Rated current [A]



Technical Specifications

| | |
|--|--|
| Maximum continuous operating voltage | 250 VOLT, 50/60 Hz |
| Operating frequency | DC to 400 Hz |
| Rated currents | 2 to 6 A @ 40°C max. |
| High potential test voltage | P → PE 2000 VAC for 2 sec (standard types) P → PE 2500 VAC for 2 sec (B types) P → N 760 VAC for 2 sec |
| Protection category | IP 40 according to IEC 60529 |
| Temperature range (operation and storage) | -25°C to +85°C (25/85/21) |
| Design corresponding to | UL 1283, CSA 22.2 No. 8 1986, IEC/EN 60939 |
| Flammability corresponding to | UL 94 V-2 or better |
| MTBF @ 40°C/230 V (Mil-HB-217F) | 550,000 hours |
| Voltage selector description | VOL-SE 4SP-4 |
| Function | Series/parallel |
| Voltage marking | |
| 1st | 100 |
| 2nd | 120 |
| 3rd | 230 |
| 4st | 240 |
| Closed internal contact corresponding to | |
| 1st | a, c, e |
| 2st | b, c, e |
| 3st | 3st a, d |
| 4st | b, d |

* Other selected voltage marking on request.

Approvals & Compliances



The FN 370 power entry module combines an IEC inlet, a mains filter with a single or dual-fuse holder and a voltage selector. Choosing FN 370 product line brings you the rapid availability of a standard filter associated with the necessary safety acceptances. Standard IEC connector filters are a practical solution helping you to pass EMI system approval in a short time. A wide selection on amperage ratings, fuse options, mounting possibilities and filters for medical applications are designed to offer you the desired solution.

Features and Benefits

- Good conducted attenuation performance, based on chokes with high saturation resistance and excellent thermal behavior
- Rear/front or snap-in mounting
- Single or dual-fuse holder
- USA Ø6.3 x 32 mm or EU Ø5 x 20 mm fuses
- Two attenuation performance ranges
- Voltage selector 100/120/230/240 V
- Custom-specific versions are available on request

Typical Applications

- Portable electrical and electronic equipment
- Consumer goods
- EDP and office equipment
- Single-phase power supplies, switch-mode power supplies
- Test and measurement equipment
- Medical equipment

Typical electrical schematic

FN 370 / FN 376

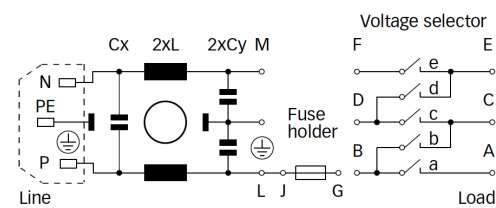

FN 372 / FN 378 / FN 379

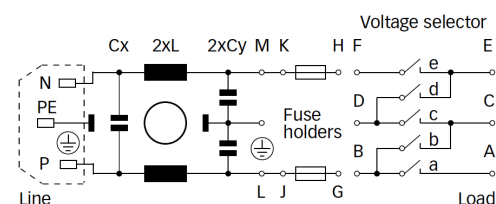

Filter Selection Table

| Filter* | Rated current @ 40°C (25°C) [A] | Leakage current** @ 230 VAC/50 Hz [µA] | Inductance L [mH] | Capacitance | | Resistance R [kΩ] | Output connections | Fuses*** [Qty] | Weight [g] |
|-----------------------|---------------------------------------|--|-------------------------|-------------|------------|-------------------------|-----------------------|-------------------|---------------|
| | | | | Cx [nF] | Cy [nF] | | | | |
| FN 370-2-2 z | 2 (2.4) | 373 | 0.70 | 47 | 2.2 | | 13 | 1 | 55 |
| FN 370-4-2 z | 4 (4.8) | 373 | 0.30 | 47 | 2.2 | | 13 | 1 | 55 |
| FN 370-6-2 z | 6 (7.2) | 373 | 0.18 | 47 | 2.2 | | 13 | 1 | 55 |
| FN 372-2-2 z | 2 (2.4) | 373 | 0.70 | 47 | 2.2 | | 13 | 2 | 55 |
| FN 372-4-2 z | 4 (4.8) | 373 | 0.30 | 47 | 2.2 | | 13 | 2 | 55 |
| FN 372-6-2 z | 6 (7.2) | 373 | 0.18 | 47 | 2.2 | | 13 | 2 | 55 |
| FN 378-2-2 z | 2 (2.4) | 373 | 0.70 | 47 | 2.2 | | 13 | 2 | 60 |
| FN 378-4-2 z | 4 (4.8) | 373 | 0.30 | 47 | 2.2 | | 13 | 2 | 60 |
| FN 378-6-2 z | 6 (7.2) | 373 | 0.18 | 47 | 2.2 | | 13 | 2 | 60 |
| FN 379-2-2 z | 2 (2.4) | 373 | 2.00 | 47 | 2.2 | | 13 | 2 | 70 |
| FN 379-4-2 z | 4 (4.8) | 373 | 0.80 | 47 | 2.2 | | 13 | 2 | 70 |
| FN 379-6-2 z | 6 (7.2) | 373 | 0.50 | 47 | 2.2 | | 13 | 2 | 70 |
| FN 379 B-2-2 z | 2 (2.4) | 2 | 2.00 | 47 | | 1000 | 13 | 2 | 70 |
| FN 379 B-4-2 z | 4 (4.8) | 2 | 0.80 | 47 | | 1000 | 13 | 2 | 70 |
| FN 379 B-6-2 z | 6 (7.2) | 2 | 0.50 | 47 | | 1000 | 13 | 2 | 70 |

* Select the requested fuse holder for fuse EUR-1 or USA-1 (z).





** Maximum leakage under normal operating conditions. Note: if the neutral line is interrupted, worst case leakage could reach twice this level.

*** Filters are delivered without fuse.

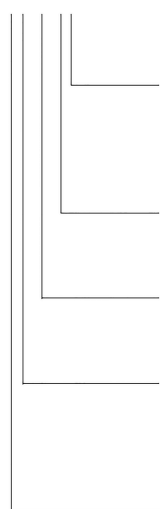
Product selector

FN 37xx-y-zz



- 1: Fuse Ø5 x 20mm (FUSE-H EUR-1)
- 2: Fuse Ø6.3 x 32mm (FUSE-H USA-1)
- 2: Voltage selector, series / parallel 100/120/230/240V
- 2 to 6: Rated current
- Blank: Standard version
- B: Medical version (with bleed resistor and without Y2-capacitor)
- 0:  Snap-in version, single-fuse, standard performance
- 2:  Snap-in version, dual-fuse, standard performance
- 8:  Flange mounting version, dual-fuse, standard performance
- 9:  Flange mounting version, dual-fuse, high performance

For example: FN 370-6-21, FN 378-4-22, FN 379 B-2-22

Typical Filter Attenuation

Per CISPR 17; A=50 Ω/50 Ω sym; B=50 Ω/50 Ω asym; C=0.1 Ω/100 Ω sym; D=100 Ω/0.1 Ω sym

FN 370/FN 372/FN 378

FN 379

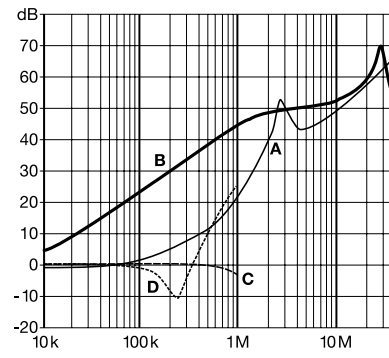
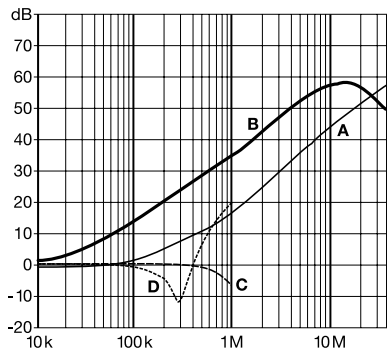

Mechanical Data

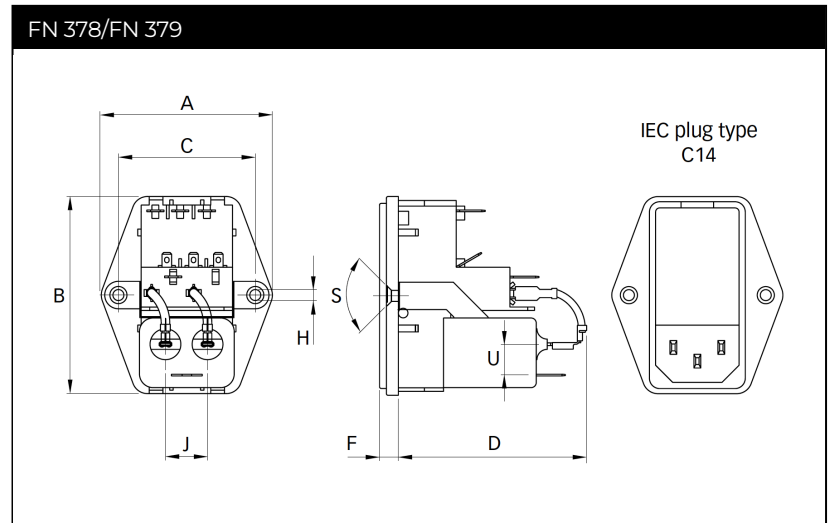
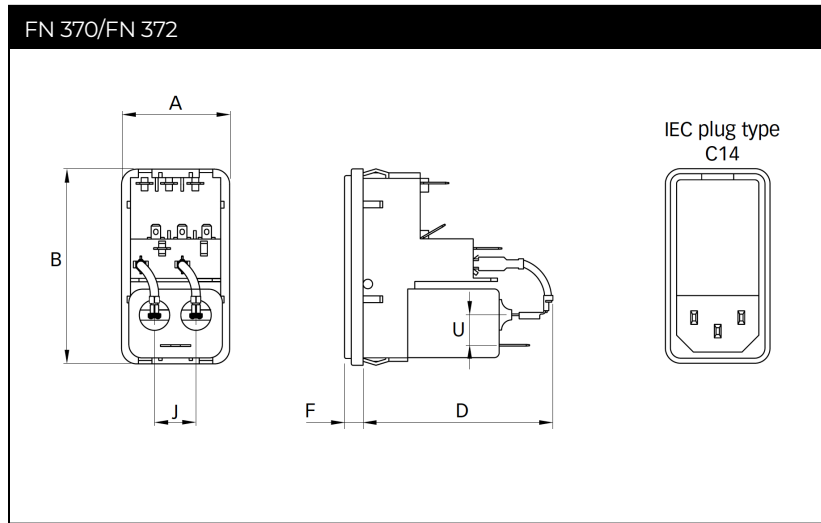

Connection designation

Panel cut out

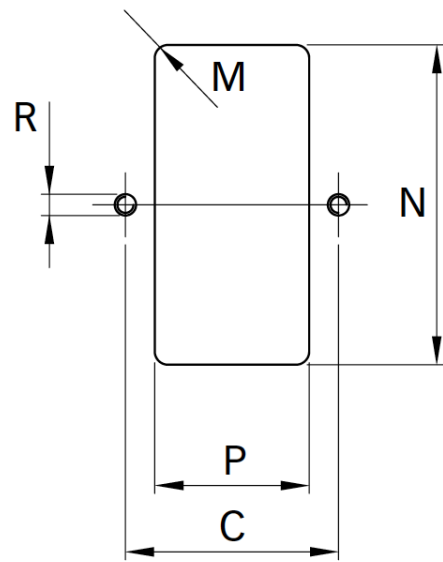
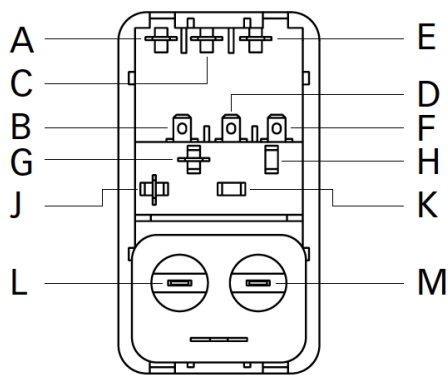

Dimensions

| | FN 370 | FN 372 | FN 378 | FN 379 | Tolerances |
|----------|--------------|--------------|--------------|--------------|------------|
| A | 32 | 32 | 50 | 50 | ±0.3 |
| B | 58 | 58 | 58 | 58 | ±0.3 |
| C | | | 40 | 40 | ±0.1 |
| D | 54 | 54 | 54 | 64.5 | |
| F | 5.5 | 5.5 | 5.5 | 5.5 | |
| H | | | Ø3.3 | Ø3.3 | |
| J | 12.5 | 12.5 | 12.5 | 12.5 | |
| M | R ≤2 | R ≤2 | R ≤2 | R ≤2 | ±0.1 |
| N | 55.9*/56.2** | 55.9*/56.2** | 55.9*/56.2** | 55.9*/56.2** | +0.2/-0 |
| P | 28.5 | 28.5 | 28.5 | 28.5 | +0.2/-0 |
| R | | | M3 | M3 | |
| S | | | 90° | 90° | |
| U | 9 | 9 | 9 | 9 | |

* For a panel thickness between 0.8 and 3 mm

** For a back panel thickness between 2.1 and 3.2 mm

All dimensions in mm; 1 inch = 25.4 mm

Tolerances according: ISO 2768-m/EN 22768-m

Please visit www.schaffner.com to find more details on filter connectors.