

Versatile Filtered Power Entry Module

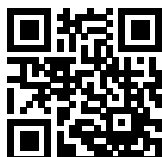

- Rated currents up to 10 A
- For one or two fuses
- Fuses Ø6.3 x 32 mm or Ø5 x 20 mm
- 2-pole rocker switch
- Voltage selector
- Optional earth line choke (E type)



Performance indicators

Attenuation performance



Rated current [A]



Approvals & Compliances



The FN 390 power entry module combines an IEC inlet, mains filter with single or dual-fuse holder, voltage selector and 2-pole rocker switch. Choosing FN 390 product line brings you the rapid availability of a standard filter associated with the necessary safety acceptances. Standard IEC connector filters are a practical solution helping you to pass EMI system approval in a short time. Multiple options designed to offer you the desired solution.

Features and Benefits

- High conducted attenuation performance, based on chokes with high saturation resistance and excellent thermal behavior
- Rear or front mounting
- Single or dual-fuse holder
- USA Ø6.3 x 32 mm or EU Ø5 x 20 mm fuses
- 2-pole rocker switch
- Voltage selector 110-120 V/220-240 V
- Custom-specific versions are available on request

Technical Specifications

Maximum continuous operating voltage	250 VAC, 50/60 Hz
Operating frequency	DC to 400 Hz
Rated currents	1 to 10 A @ 40°C max.
High potential test voltage	P → PE 2000 VAC for 2 sec P → N 760 VAC for 2 sec
Protection category	IP 40 according to IEC 60529
Temperature range (operation and storage)	-25°C to +85°C (25/85/21)
Design corresponding to	UL 1283, CSA 22.2 No. 8 1986, IEC/EN 60939
Flammability corresponding to	UL 94V-2 or better
MTBF @ 40°C/230 V (Mil-HB-217F)	2,200,000 hours
Voltage selector description	
Function	Series/parallel
Voltage marking	
Series	110-120 V
Parallel	220-240 V
Rocker switch description	
Fuse holder	1 or 2 fuses (Ø5 x 20 mm) (certified to IEC 60127-6), power acceptance 1.6W @ Ta 23°C per pole for 2 fuses. 2.5W, if only 1 pole is used.
Function	2-pole, dark not illuminated Marking I - 0
Electrical specifications	Inrush current 51 A 6,000 on-off operations according to UL 1054, TV 5 10,000 on-off operations according to ENEC
Mechanical life	50,000 cycles
Switch ratings	
USA (UL) and Canada (C-UL)	10 A, 125 VAC; 10 A, 250 VAC; 1/3 HP
Europe (ENEC)	10 A (4 A), 250 VAC*

Typical Applications

- Portable electrical and electronic equipment
- Consumer goods
- EDP and office equipment
- Single-phase power supplies, switch-mode power supplies
- Test and measurement equipment

Typical electrical schematic

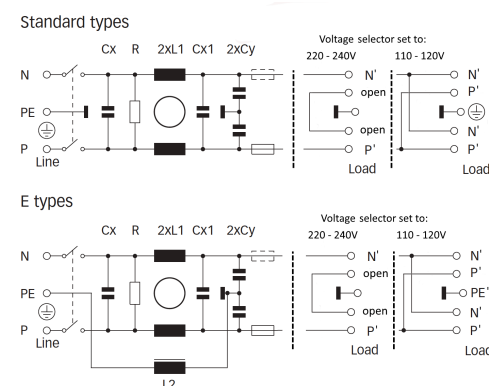

* Value in () relates to the inductive current charge: $\cos \varphi = 0.65$

Filter Selection Table

Filter	Rated current	Leakage current*	Inductance		Capacitance			Resistance	Output	Fuses**	Weight
	@ 40°C (25°C)	@ 230 VAC/50 Hz	L1	L2	Cx	Cx1	Cy	R	connections	[Qty]	[g]
	[A]	[µA]	[mH]	[mH]	[nF]	[nF]	[nF]	[kΩ]			
FN 393-1-05-11	1 (1.2)	560	7.5		220		3.3	1000	05-11	1	200
FN 393-2.5-05-11	2.5 (3)	560	2		220		3.3	1000	05-11	1	200
FN 393-6-05-11	6 (7.2)	560	0.45		220		3.3	1000	05-11	1	200
FN 394-1-05-11	1 (1.2)	560	7.5		220		3.3	1000	05-11	2	200
FN 394-2.5-05-11	2.5 (3)	560	2		220		3.3	1000	05-11	2	200
FN 394-6-05-11	6 (7.2)	560	0.45		220		3.3	1000	05-11	2	200
FN 393 E-1-05-11	1 (1.2)	560	7.5	0.4	220		3.3	1000	05-11	1	205
FN 393 E-2.5-05-11	2.5 (3)	560	2	0.4	220		3.3	1000	05-11	1	205
FN 393 E-6-05-11	6 (7.2)	560	0.45	0.4	220		3.3	1000	05-11	1	205
FN 394 E-1-05-11	1 (1.2)	560	7.5	0.4	220		3.3	1000	05-11	2	205
FN 394 E-2.5-05-11	2.5 (3)	560	2	0.4	220		3.3	1000	05-11	2	205
FN 394 E-6-05-11	6 (7.2)	560	0.45	0.4	220		3.3	1000	05-11	2	205
FN 1393-1-05-11	1 (1.2)	797	16		220	100	4.7	470	05-11	1	210
FN 1393-2.5-05-11	2.5 (3)	797	8		220	100	4.7	470	05-11	1	210
FN 1393-6-05-11	6 (7.2)	797	2.5		220	100	4.7	470	05-11	1	210
FN 1393-10-05-11	10 (12)	797	0.6		220	100	4.7	470	05-11	1	210
FN 1394-1-05-11	1 (1.2)	797	16		220	100	4.7	470	05-11	2	210
FN 1394-2.5-05-11	2.5 (3)	797	8		220	100	4.7	470	05-11	2	210
FN 1394-6-05-11	6 (7.2)	797	2.5		220	100	4.7	470	05-11	2	210
FN 1394-10-05-11	10 (12)	797	0.6		220	100	4.7	470	05-11	2	210

* Maximum leakage under normal operating conditions. Note: if the neutral line is interrupted, worst case leakage could reach twice this level.

** Filters are delivered without fuse.

Note: for medical versions please contact your local partner within Schaffner's global network.

Product selector

FN (1)39xx-y-zz

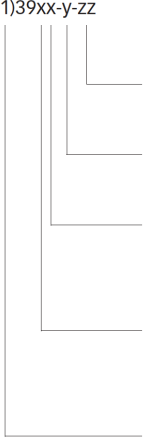

- 05-11: Faston 6.3 x 0.8mm
- 1 to 10: Rated current
- Blank: Standard version
- E: Optional earth line choke
- 3: 1 fuse (Ø5 x 20mm or Ø6.3 x 32mm)
- 4: 2 fuses (Ø5 x 20mm or Ø6.3 x 32mm)
- Blank: Standard version
- 1: Additional Cx1 capacitor and higher inductivity

For example: FN 393-1-05-11, FN 394 E-2.5-05-11, FN 1394-10-05-11

Typical Filter Attenuation

Per CISPR 17; A=50 Ω/50 Ω sym; B=50 Ω/50 Ω asym; C=0.1 Ω/100 Ω sym; D=100 Ω/0.1 Ω sym

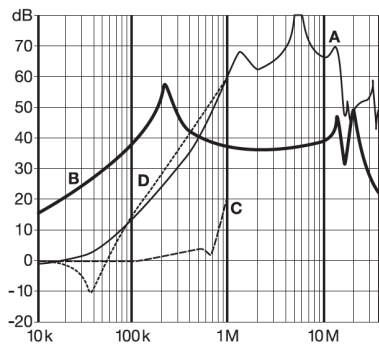

FN 39x: 1 A types

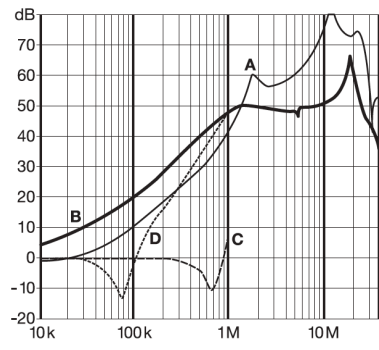

FN 39x: 2.5 A types

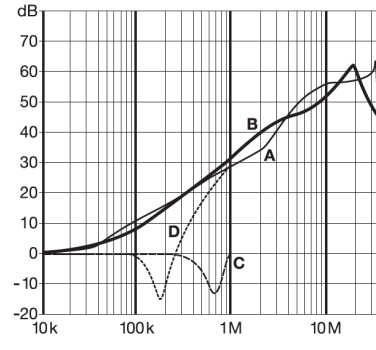

FN 39x: 6 A types

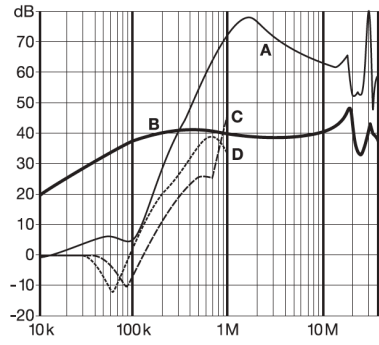

FN 139x: 1 A types

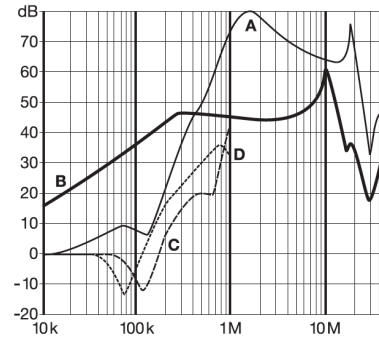

FN 139x: 2.5 A types

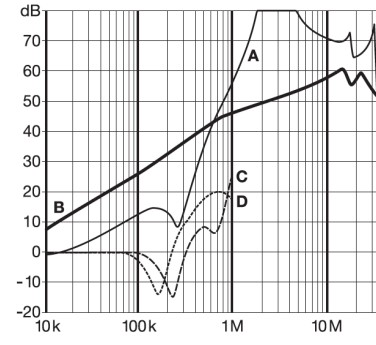

FN 139x: 6 and 10 A types

Mechanical Data

1 to 10 A types

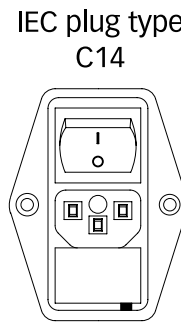
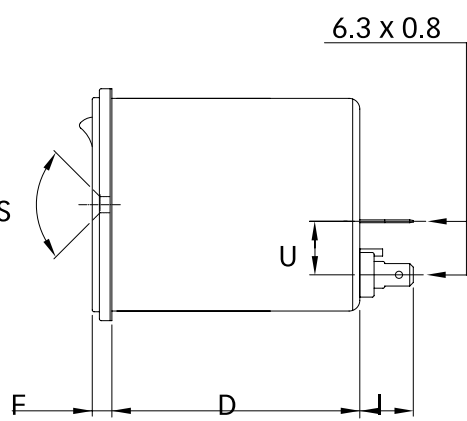
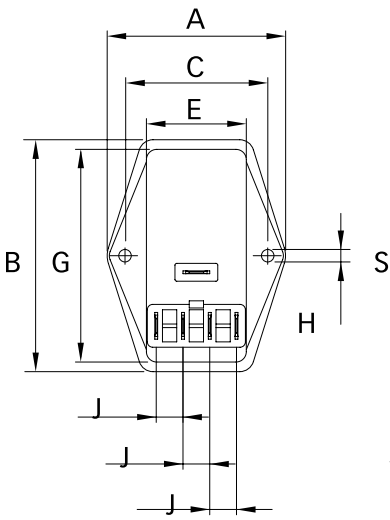

Panel cut out

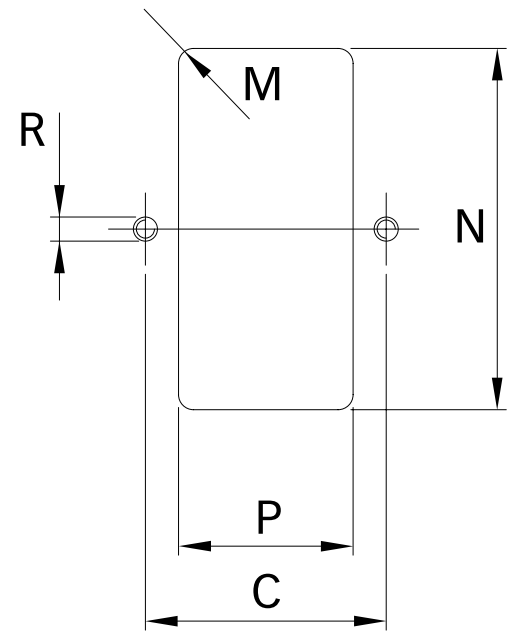

Dimensions

	1 to 10 A	Tolerances
A	50	±0.3
B	65	±0.3
C	40	±0.1
D	70	±0.5
E	28.5	±0.3
F	5.5	±0.3
G	59.8	±0.2
H	Ø 3.3	
I	13.5	±0.5
J	7.5	
M	R ≤ 2.5	
N	60	+0.5/-0
P	29	+0.5/-0
R	M3	
S	90°	
U	15	±0.3

All dimensions in mm; 1 inch=25.4 mm

Tolerances according: ISO 2768-m/EN 22768-m

Please visit www.schaffner.com to find more details on filter connections.