

High Performance IEC Inlet Filter

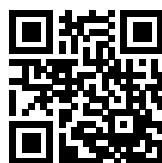

- Rated currents up to 20 A
- Optional medical versions (B type)
- Rear mounting
- Excellent attenuation in the lower frequency range



Performance indicators

Attenuation performance



Rated current [A]



Approvals & Compliances



The FN 9246 IEC inlet filter combines an IEC inlet and mains filter with excellent filter attenuation in a small form factor. Choosing the FN 9246 product line brings you the rapid availability of a standard filter associated with the necessary safety acceptances. Standard IEC connector filters are a practical solution helping you to pass EMI system approval in a short time. A wide selection on current ratings and low leakage versions for medical applications are designed to offer you the desired solution.

Features and Benefits

- Excellent conducted attenuation performance, based on chokes with high saturation resistance and excellent thermal behavior
- Rear mounting
- FN 9246 B versions comply with the requirements of 1MOP acc. to IEC/EN 60601-1 for creepage and clearance, leakage current and high potential testing
- Rated currents up to 20 A
- Custom-specific versions are available on request

Technical Specifications

Maximum continuous operating voltage	250 VAC, 50/60 Hz
Operating frequency	DC to 400 Hz
Rated currents	1 to 20 A @ 50°C
Approvals by rated current	1 to 10 A (Semko) 16 A (Semko) for 16 and 20 A types 1 to 20 A (UL, CSA)
High potential test voltage	P → N 1100 VDC for 2 sec (16 and 20 A types) P → PE 2000 VAC for 2 sec (standard types) P → PE 2500 VAC for 2 sec (B types) P → N 1100 VAC for 2 sec (1 to 10 A types)
Protection category	IP 40 according to IEC 60529
Temperature range (operation and storage)	-25°C to +85°C (25/85/21)
Design corresponding to	UL 1283, CSA 22.2 No. 8 1986, IEC/EN 60939
Flammability corresponding to	UL 94 V-2 or better
MTBF @ 40°C/230 V (Mil-HB-217F)	1,600,000 hours

Typical Applications

- Electrical and electronic equipment
- Small to medium-sized machines and household equipment
- Single-phase power supplies, switch-mode power supplies
- Test and measurement equipment
- Building automation
- Medical equipment
- Lighting application

Typical electrical schematic

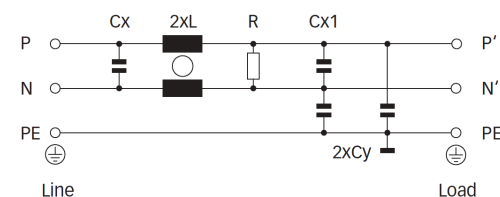

Filter Selection Table

Filter	Rated current @ 40°C (25°C) [A]	Leakage current* @ 250 VAC/50 Hz (@ 120 VAC/60 Hz) [mA]	Inductance L [mH]	Capacitance		Resistance R [kΩ]	Output connections 	Weight [g]
				Cx [μF]	Cy [nF]			
FN 9246-1-06	1 (1.2)	0.31 (0.18)	50	1.22	2.2	470	-06	140
FN 9246-3-06	3 (3.5)	0.31 (0.18)	14	1.22	2.2	470	-06	140
FN 9246-6-06	6 (7.2)	0.31 (0.18)	7	1.22	2.2	470	-06	140
FN 9246-10-06	10 (12)	0.31 (0.18)	3	1.22	2.2	470	-06	140
FN 9246-12-06	12 (14)	0.31 (0.18)	1.85	1.22	2.2	470	-06	140
FN 9246-15-06	15 (18)	0.31 (0.18)	0.89	1.22	2.2	470	-06	140
FN 9246-16-06	16 (18.5)	0.66 (0.38)	2.5	1.22	4.7	470	-06	275
FN 9246-20-06	20 (23)	0.66 (0.38)	1.5	1.22	4.7	470	-06	275
FN 9246 B-1-06	1 (1.2)	0.00	50	1.22		470	-06	140
FN 9246 B-3-06	3 (3.5)	0.00	14	1.22		470	-06	140
FN 9246 B-6-06	6 (7.2)	0.00	7	1.22		470	-06	140
FN 9246 B-10-06	10 (11.6)	0.00	3	1.22		470	-06	140
FN 9246 B-12-06	12 (14)	0.00	1.85	1.22		470	-06	140
FN 9246 B-15-06	15 (18)	0.00	0.89	1.22		470	-06	140
FN 9246 B-16-06	16 (18.5)	0.00	2.5	1.22		470	-06	275
FN 9246 B-20-06	20 (23)	0.00	1.5	1.22		470	-06	275

* Maximum leakage under normal operating conditions (acc. to IEC60939-3). Note: if the neutral line is interrupted, worst case leakage could reach twice this level.

Typical Filter Attenuation

Per CISPR 17; A=50 Ω/50 Ω sym; B=50 Ω/50 Ω asym; C=0.1 Ω/100 Ω sym; D=100 Ω/0.1 Ω sym

1 and 3 A types

6 to 10 A types

12 and 15 A types

16 and 20 A types

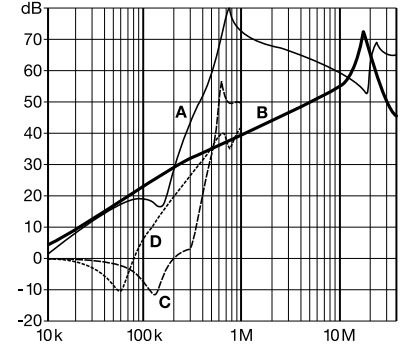
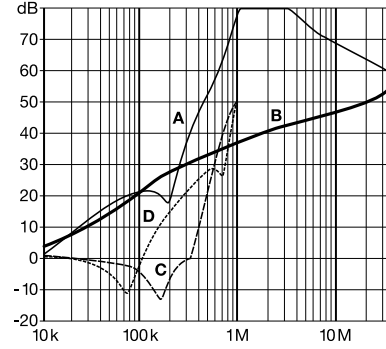
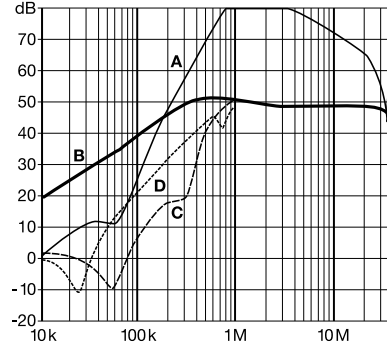
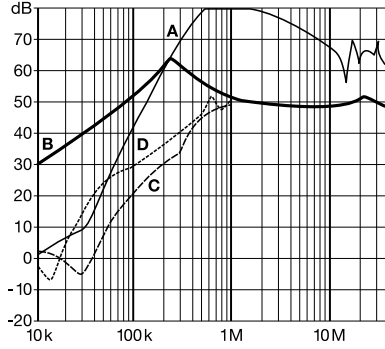

Product selector

FN 9246x-yy-..

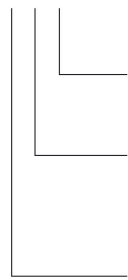

- 06: Faston 6.3 x 0.8mm (spade/soldering)
- 1 to 20: Rated current
Standard IEC inlet type C14 (1 to 15A types), C20 (16 and 20A types)
- Blank: Standard version
- B: Medical version (with bleed resistor and without Y2-capacitor)

For example: FN 9246-6-06, FN 9246 B-10-06

Mechanical Data

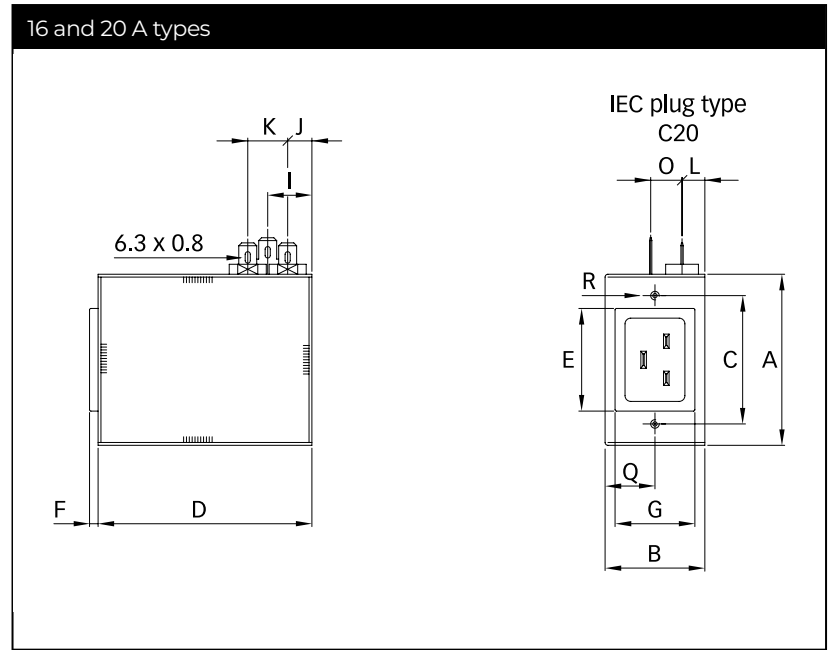
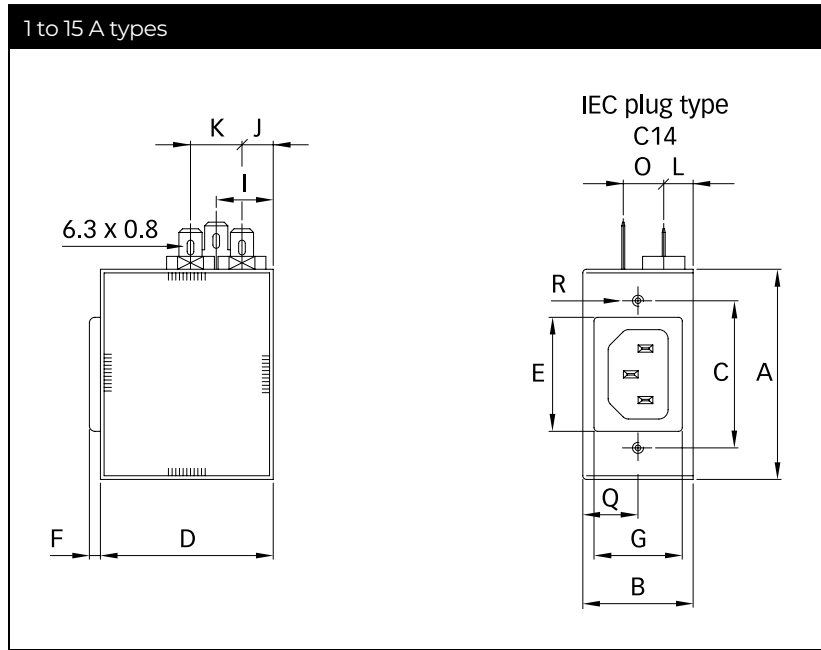

Panel cut out

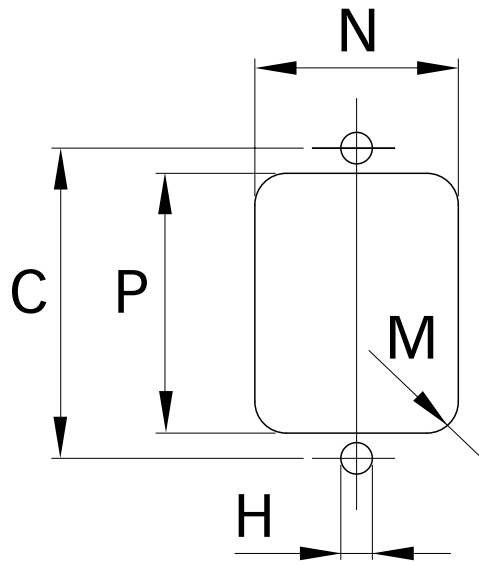

	1 A	3 A	6 A	10 A	12 A	15 A	16 A	20 A	
A	57.15	57.15	57.15	57.15	57.15	57.15	60	60	
B	30	30	30	30	30	30	35	35	
C	40	40	40	40	40	40	45	45	
D	47	47	47	47	47	47	75	75	
E	31	31	31	31	31	31	36	36	
F	3	3	3	3	3	3	3	3	
G	24	24	24	24	24	24	28	28	
H	Ø3.5	Ø3.5	Ø3.5	Ø3.5	Ø3.5	Ø3.5	Ø3.5	Ø3.5	
I	15.5	15.5	15.5	15.5	15.5	15.5	15.5	15.5	
J	8.5	8.5	8.5	8.5	8.5	8.5	8.5	8.5	
K	14	14	14	14	14	14	14	14	
L	8	8	8	8	8	8	8	8	
M	R ≤ 1.5	R ≤ 1.5	R ≤ 1.5	R ≤ 1.5	R ≤ 1.5	R ≤ 1.5	R ≤ 1.5	R ≤ 1.5	
N	25	25	25	25	25	25	29	29	
O	11	11	11	11	11	11	11	11	
P	32	32	32	32	32	32	37	37	
Q	15	15	15	15	15	15	17.5	17.5	
R				M3 x 10 max.					

All dimensions in mm; 1 inch = 25.4 mm
 Tolerances according: ISO 2768-m/EN 22768-m

Accessories

Power Cord with angled Locking System C13



- Protects appliances that are vulnerable to vibration
- Connector cannot be accidentally pulled or vibrated out of the inlet
- Space availability/constraints
- Different angles for ease of access
- Space saving
- Release locking mechanism
- Prevents accidental disconnection

[Technical Data Sheet >](#)

IL 13P IEC C13 Rewireable Angled Connectors with Locking System



- Protects appliances that are vulnerable to vibration
- Connector cannot be accidentally pulled or vibrated out of the inlet
- Space availability/constraints
- Different angles for ease of access
- Space saving
- Release locking mechanism
- Prevents accidental disconnection

[Technical Data Sheet >](#)

IL 13P IEC C13 Rewireable Connectors with Locking System

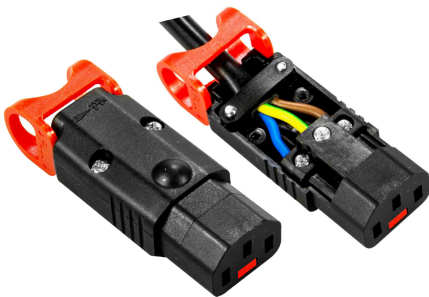

The locking system has a tensile force of typical 300N. It is recommended to use it with flange mount filters. For details refer to our Application Note "Using IEC Lock Power Cords with IEC Inlets and Filters".

Schaffner power connector with IEC lock guard against accidental disconnection of all electrical appliances with an IEC inlet. No exchange or modification of the IEC inlet or IEC inlet filter system is needed. Easy retrofit for all electronic equipments and devices

[Technical Data Sheet >](#)