

High performance dual-stage IEC C14 and C20 inlet filter



- Rated currents up to 20 A
- Excellent performance/size ratio
- IEC C14 or C20 inlet acc. IEC 60320-1
- Medical versions (B type) acc. to IEC/EN 60601-1
- Snap-in and rear mount versions (S and M type)
- Earth line choke version (Refer to FN9255E)
- Safe voltage discharge version (R-type)



Performance indicators

Attenuation performance



Rated current [A]

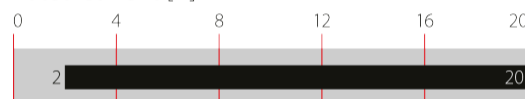

Approvals & Compliances



The FN9255 IEC inlet filter incorporates a dual stage filter into an IEC inlet that offers excellent filter attenuation in a compact housing. Using an IEC inlet, at the point of entry offers an optimized position and practical solution for integrating an EMC filter into any system. A wide selection of current ratings, output connections and mounting possibilities are available. The filter family also offers options that comply to medical application requirements and the entire family complies to all necessary safety approvals.

Features and Benefits

- Exceptional attenuation performance from 150kHz to 300MHz due to dual-stage design
- High saturation resistance and excellent thermal behavior
- Rear and Front flange or snap-in mounting options
- FN 9255 B versions comply with the requirements of 1MOP acc. to IEC/EN 60601-1 for creepage and clearance, leakage current and high potential testing
- Optional earth line choke see FN 9255 E versions
- All versions according IEC/EN 62368-1

Technical Specifications



| | |
|------------------------------------------------------|------------------------------------------------------------------------------------------------------------------------------------------------|
| Maximum continuous operating voltage | 250 VAC, 50/60 Hz |
| Rated currents | 2 to 20 A @ 40°C max |
| Operating frequency | DC to 400 Hz |
| Approvals by rated current | ENEC and CQC: IEC C14 Inlet - 2 to 10 A ENEC and CQC: IEC C20 Inlet - 16 A UL: IEC C14 Inlet - 2 to 15A UL: IEC C20 Inlet - 16 to 20A |
| High potential test voltage | P → PE 2000 VAC for 2 sec (standard types) P → PE 2500 VAC for 2 sec (B types) P → N 760 VAC for 2 sec |
| Protection category | IP 40 according to IEC 60529 |
| Temperature range (operation and storage) | -25°C to +85°C (25/85/21) |
| Design corresponding to | UL 60939-3, CSA Std C22.2 No. 8, IEC/EN 60939-3, GB/T 15287, GB/T 15288 |
| Surge pulse protection (Z type) | Helps compliance to IEC61000-4-5 (Differential Mode only) |
| Flammability according to | UL 94 V-0 |
| MTBF @ Rated amb. Temp./Voltage (Mil-HB-217F) | > 1,000,000 hours |

Typical Applications

- Medical devices (MDD)
- In-vitro diagnostic medical devices (IVDD)
- Computing & accessories
- LCD and OLED Displays
- Test and measurement equipment
- Household and similar products as per IEC/EN55014
- Portable electrical and electronic equipment
- Small to medium-sized machines
- Single-phase power supplies, switch-mode power supplies (SMPS)

For electrical schematic refer to page 3

Filter Selection Table

| Filter | Rated current @ 40°C | Leakage current* @ 250 VAC/50 Hz (@ 120 VAC/60 Hz) | Inductance | | Capacitance | | | Resistor R | Input connections | Output connections | | Weight |
|------------------|-------------------------|----------------------------------------------------------|------------|------|-------------|------|------|---------------|----------------------|-------------------------------------------------------------------------------------|-------------------------------------------------------------------------------------|--------|
| | | | L1 | L2 | Cx | Cy1 | Cy2 | | | ** | ** | |
| - | - | - | - | - | - | - | - | - | - | - | - | |
| - | [A] | [mA] | [mH] | [μH] | [μF] | [nF] | [nF] | [kΩ] | |  |  | [g] |
| FN 9255 x-2-.. | 2 | 0.45 (0.26) | 4.8 | 18 | 0.1 | 2.2 | 1 | - | C14 | -06 | -07 | 52 |
| FN 9255 x-4-.. | 4 | 0.45 (0.26) | 2.1 | 18 | 0.1 | 2.2 | 1 | - | C14 | -06 | -07 | 52 |
| FN 9255 x-6-.. | 6 | 0.45 (0.26) | 0.9 | 18 | 0.1 | 2.2 | 1 | - | C14 | -06 | -07 | 52 |
| FN 9255 x-10-.. | 10 | 0.45 (0.26) | 0.2 | 18 | 0.1 | 2.2 | 1 | - | C14 | -06 | -07 | 54 |
| FN 9255 x-15-.. | 15 | 0.45 (0.26) | 0.13 | 8 | 0.1 | 2.2 | 1 | - | C14 | -06 | -07 | 54 |
| FN 9255 x-16-.. | 16 | 0.45 (0.26) | 0.3 | 0.7 | 0.1 | 2.2 | 1 | - | C20 | -06 | -07 | 130 |
| FN 9255 x-20-.. | 20 | 0.45 (0.26) | 0.3 | 0.7 | 0.1 | 2.2 | 1 | - | C20 | -06 | -07 | 130 |
| FN 9255 xB-2-.. | 2 | - | 4.8 | 18 | 0.1 | - | - | 1000 | C14 | -06 | -07 | 52 |
| FN 9255 xB-4-.. | 4 | - | 2.1 | 18 | 0.1 | - | - | 1000 | C14 | -06 | -07 | 52 |
| FN 9255 xB-6-.. | 6 | - | 0.9 | 18 | 0.1 | - | - | 1000 | C14 | -06 | -07 | 52 |
| FN 9255 xB-10-.. | 10 | - | 0.2 | 18 | 0.1 | - | - | 1000 | C14 | -06 | -07 | 54 |
| FN 9255 xB-15-.. | 15 | - | 0.13 | 8 | 0.1 | - | - | 1000 | C14 | -06 | -07 | 54 |
| FN 9255 xB-16-.. | 16 | - | 0.3 | 0.7 | 0.1 | - | - | 1000 | C20 | -06 | -07 | 130 |
| FN 9255 xB-20-.. | 20 | - | 0.3 | 0.7 | 0.1 | - | - | 1000 | C20 | -06 | -07 | 130 |
| FN 9255 xR-2-.. | 2 | 0.45 (0.26) | 4.8 | 18 | 0.1 | - | - | 1000 | C14 | -06 | -07 | 52 |
| FN 9255 xR-4-.. | 4 | 0.45 (0.26) | 2.1 | 18 | 0.1 | - | - | 1000 | C14 | -06 | -07 | 52 |
| FN 9255 xR-6-.. | 6 | 0.45 (0.26) | 0.9 | 18 | 0.1 | - | - | 1000 | C14 | -06 | -07 | 52 |
| FN 9255 xR-10-.. | 10 | 0.45 (0.26) | 0.2 | 18 | 0.1 | - | - | 1000 | C14 | -06 | -07 | 54 |
| FN 9255 xR-15-.. | 15 | 0.45 (0.26) | 0.13 | 8 | 0.1 | - | - | 1000 | C14 | -06 | -07 | 54 |
| FN 9255 xR-16-.. | 16 | 0.45 (0.26) | 0.3 | 0.7 | 0.1 | - | - | 1000 | C20 | -06 | -07 | 130 |
| FN 9255 xR-20-.. | 20 | 0.45 (0.26) | 0.3 | 0.7 | 0.1 | - | - | 1000 | C20 | -06 | -07 | 130 |

Test conditions: 25°C±2°C; Measuring frequency for Inductance: 1 kHz; 50 mV;

Tolerances: Inductance: +50%, -30%; Capacitance: ±25%; Resistor: ±15%; For mechanical tolerances refer to mechanical data section.

* Maximum leakage under normal operating conditions (acc. to IEC60939-3). Note: if the neutral line is interrupted, worst case leakage could reach twice this level.

** Standard length is 100 mm

Product selector

FN9255 wx -yy-...-(zz)

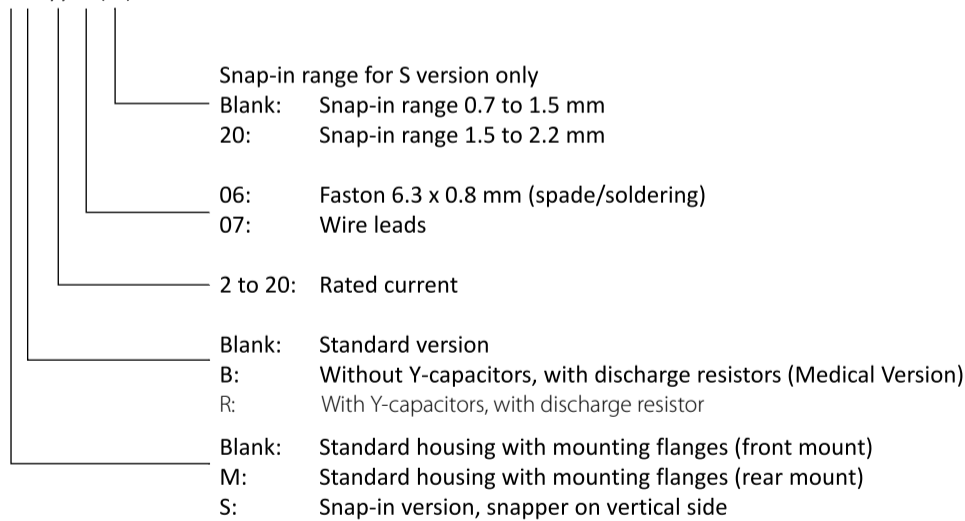

For example: FN 9255 MB-15-06 - FN 9255 dual stage IEC inlet with rear mount flanges, medical version, 15A rated current and fast-on terminals

Detailed Electrical Schematic

Schematic standard version (2 to 15A)

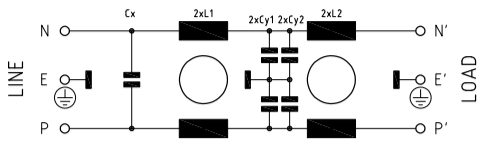

Schematic standard version (16 to 20A)

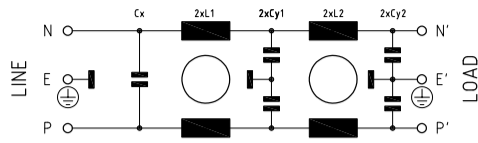

Schematic B version (2 to 20A)

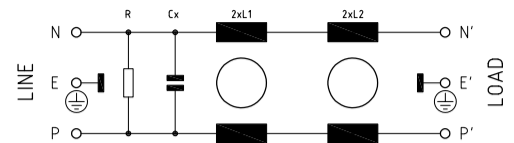

Schematic standard R version (2 to 15A)

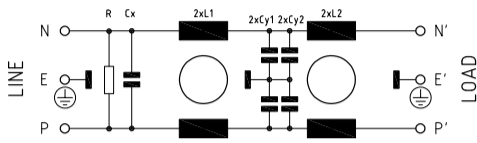

Schematic standard R version (16 to 20A)

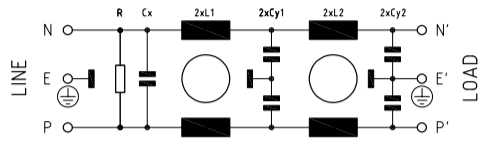

Typical Filter Attenuation

Per CISPR 17 - symmetrical 50 Ω/50 Ω - Differential Mode (DM) - asymmetrical 50 Ω/50 Ω - Common Mode (CM)

2 A (Standard Type)

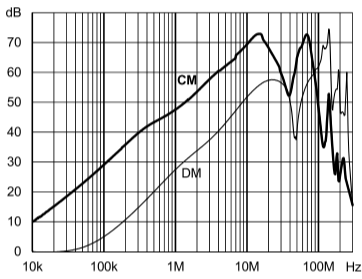

2 A (B Type)

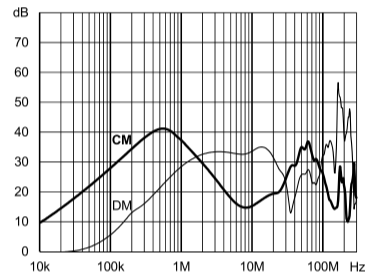

4 A (Standard Type)

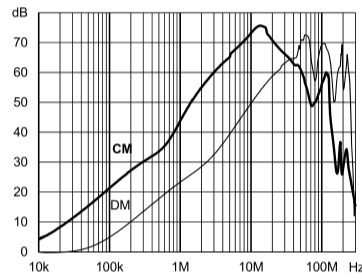

4 A (B Type)

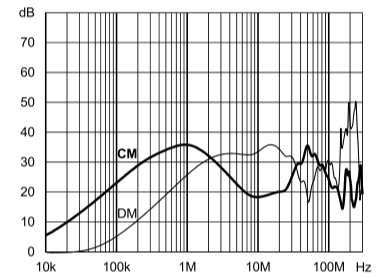

6 A (Standard Type)

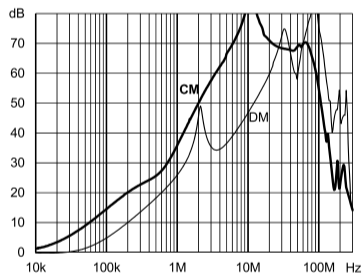

6 A (B Type)

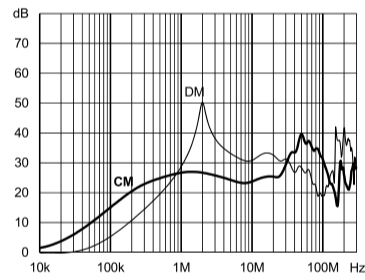

10 A (Standard Type)

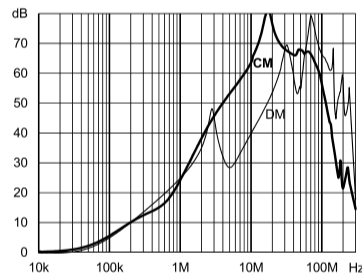

10 A (B Type)

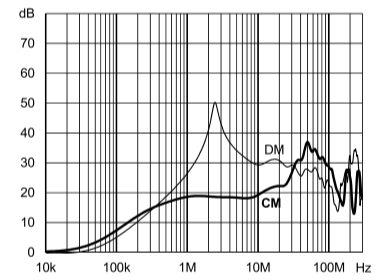

15 A (Standard Type)

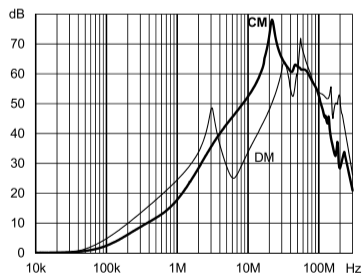

15 A (B Type)

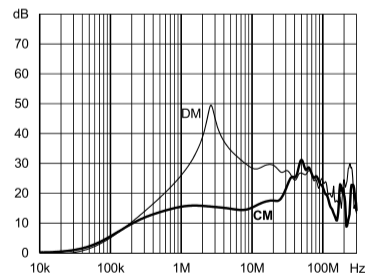

16 A (Standard Type)

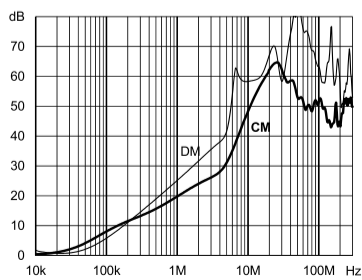

16 A (B Type)

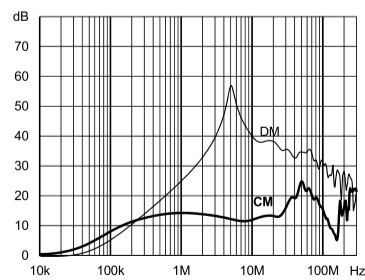

20 A (Standard Type)

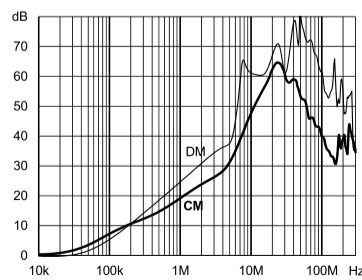

20 A (B Type)

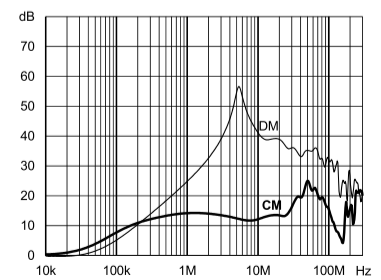

Mechanical Data

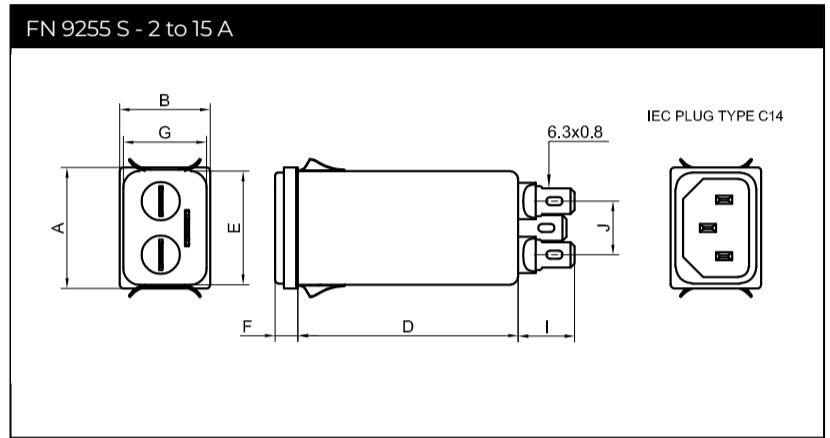
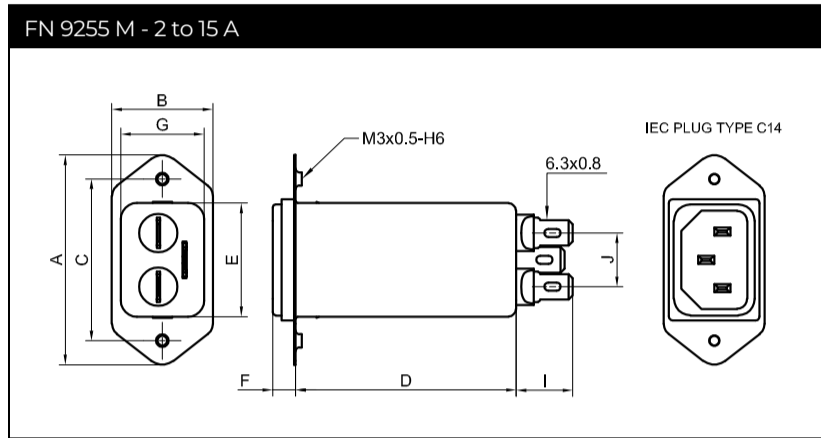
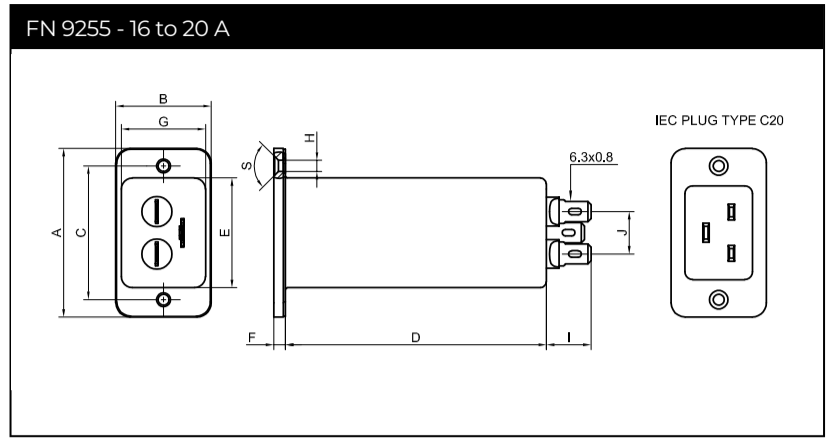
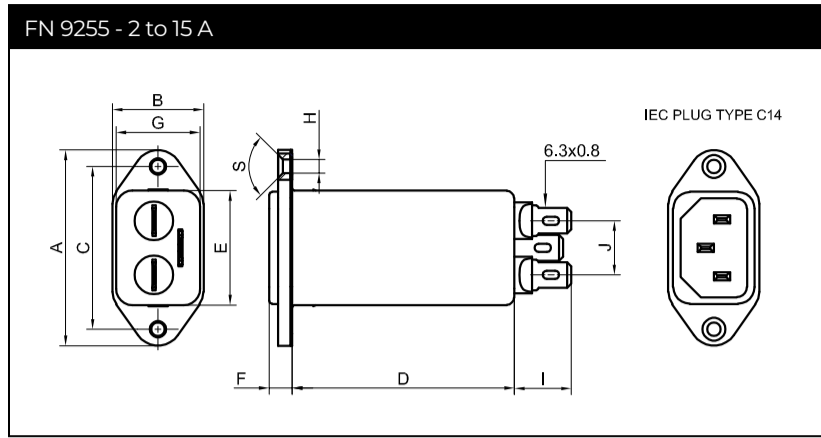

Panel cut out

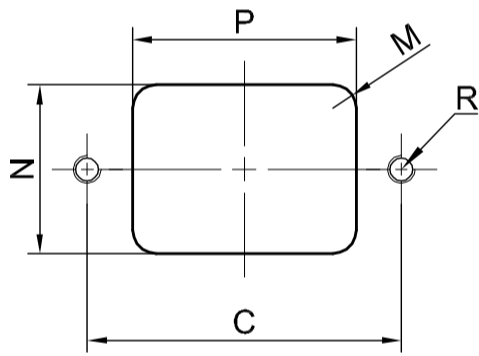

-07 connection style

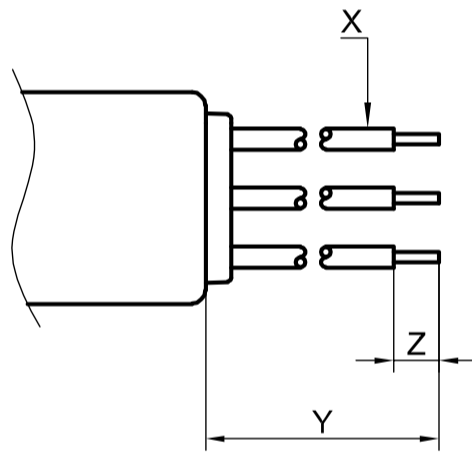

Installation

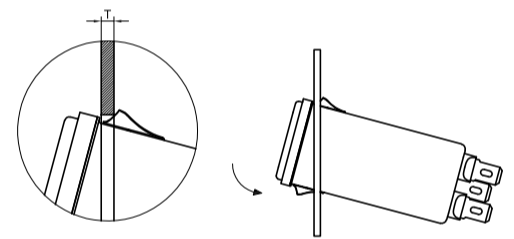

Dimensions

| | | FN 9255 | FN 9255 M | FN 9255 S |
|-----------|-------------------------|----------------|-------------------------|-------------------------|
| | 2 to 15A | 16 to 20A | | |
| A | 48 | 53 | 51.85 | 29.9 |
| B | 22.4 | 30 | 25 | 22.4 |
| C | 40±0.2 | 42±0.2 | 40±0.2 | - |
| D | -06: 54.5, -07: 52.5 | 82 | -06: 54.5, -07: 52.5 | -06: 54.5, -07: 52.5 |
| E | 28.1±0.3 | 34.6±0.3 | 28.1±0.3 | 28.1±0.3 |
| F | 5.8±0.2 | 3.9±0.2 | 5.8±0.2 | 5.8±0.2 |
| G | 20.6±0.3 | 26.7±0.3 | 20.6±0.3 | 20.6±0.3 |
| H | Ø3.3 | Ø3.5 | M3 | M3 |
| I | 14±0.5 | 14±0.5 | 14±0.5 | 14±0.5 |
| J | 13.3 | 13.3 | 13.3 | 13.3 |
| M | R ≤ 3 | R ≤ 3 | R ≤ 1 | R ≤ 1 |
| N | 21.5 +0.5/-0 | 27.1 +0.2/-0 | 22.9 +0.2/-0 | 21.0 +0.1/-0 |
| P | 28.5 +0.5/-0 | 34.9 +0.2/-0 | 30.4 +0.2/-0 | 29.5 +0.1/-0 |
| R* | M3 | M3 | Ø3.4 | Ø3.4 |
| S | 90° | 90° | | |
| T | | | | 1.5 - 2.2 |
| X | AWG 18 (>6A: AWG 16) | AWG 14 | AWG 18 (>6A: AWG 16) | AWG 18 (>6A: AWG 16) |
| Y | 100±5 | 100±5 | 100±5 | 100±5 |
| Z | 6 | 6 | 6 | 6 |

**Recommended torque for M3 (90° countersunk flat head) is 0.5 Nm

All dimensions in mm; 1 inch = 25.4 mm

For values without dedicated tolerances ISO 2768-m/EN 22768-m applies.

Please visit www.schaffner.com to find more details on connectors.

Accessories

Power Cord with Locking System



- Locking system for standardized IEC C14/C20 inlet filter
- No accidental disconnection
- Rated current up to 10 A (C13 plug), up to 15 A (C13P plug), and up to 20 A (C19 plug)
- Fits any Schaffner IEC C14/C20 inlet filter
- Retrofit for any IEC C14/C20 inlet
- Various power line plugs for international usage

[Technical Data Sheet >](#)

IL 13P IEC C13 Rewireable Angled Connectors with Locking System



- Protects appliances that are vulnerable to vibration
- Connector cannot be accidentally pulled or vibrated out of the inlet
- Space availability/constraints
- Different angles for ease of access
- Space saving
- Release locking mechanism
- Prevents accidental disconnection

[Technical Data Sheet >](#)

Power Cord with angled Locking System C13



- Protects appliances that are vulnerable to vibration
- Connector cannot be accidentally pulled or vibrated out of the inlet
- Space availability/constraints
- Different angles for ease of access
- Space saving
- Release locking mechanism
- Prevents accidental disconnection

[Technical Data Sheet >](#)