

High performance dual-stage IEC C14 and C20 inlet filter

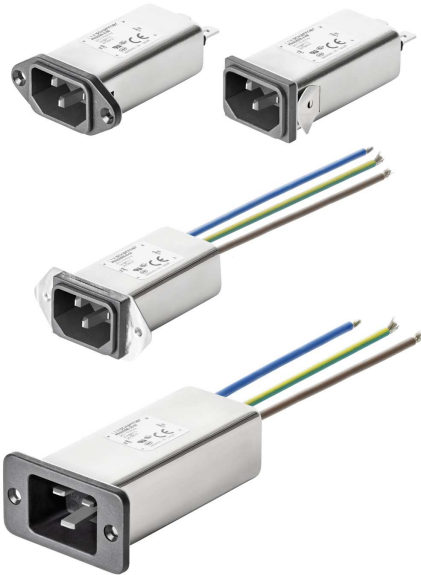

- Rated currents up to 20 A
- Excellent performance/size ratio
- IEC C14 or C20 inlet acc. IEC 60320-1
- Medical versions (B type) acc. to IEC/EN 60601-1
- Snap-in and rear mount versions (S and M type)
- Earth line choke version (Refer to FN9255E)
- Safe voltage discharge version (R-type)



Performance indicators

Attenuation performance

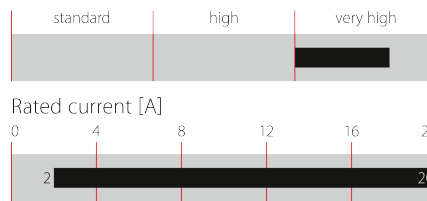

Approvals & Compliances



The FN9255 IEC inlet filter incorporates a dual stage filter into an IEC inlet that offers excellent filter attenuation in a compact housing. Using an IEC inlet, at the point of entry offers an optimized position and practical solution for integrating an EMC filter into any system. A wide selection of current ratings, output connections and mounting possibilities are available. The filter family also offers options that comply to medical application requirements and the entire family complies to all necessary safety approvals.

{GPvar:L}

Features and benefits

- Exceptional attenuation performance from 150kHz to 300MHz due to dual-stage design
- High saturation resistance and excellent thermal behavior
- Rear and Front flange or snap-in mounting options
- FN 9255 B versions comply with the requirements of 1MOP acc. to IEC/EN 60601-1 for creepage and clearance, leakage current and high potential testing
- Optional earth line choke see FN 9255 E versions
- All versions according IEC/EN 62368-1

Technical specifications



Maximum continuous operating voltage	250 VAC, 50/60 Hz
Rated currents	2 to 20 A @ 40°C max.
Operating frequency	DC to 400 Hz
Approvals by rated current	ENEC and CQC: IEC C14 Inlet - 2 to 10 A ENEC and CQC: IEC C20 Inlet - 16 A UL: IEC C14 Inlet - 2 to 15A UL: IEC C20 Inlet - 16 to 20A
High potential test voltage	P → PE 2000 VAC for 2 sec (standard types) P → N 760 VAC for 2 sec P → PE 2500 VAC for 2 sec (B types)
Protection category	IP 40 according to IEC 60529
Temperature range (operation and storage)	-25°C to +85°C (25/85/21)
Design corresponding to	UL 60939-3, CSA Std C22.2 No. 8, IEC/EN 60939-3, GB/T 15287, GB/T 15288
Flammability according to	UL 94 V-0
MTBF @ Rated amb. Temp./Voltage (Mil-HB-217F)	> 1,000,000 hours

Typical applications

- Medical devices (MDD)
- In-vitro diagnostic medical devices (IVDD)
- Computing & accessories
- LCD and OLED Displays
- Test and measurement equipment
- Household and similar products as per IEC/EN55014
- Portable electrical and electronic equipment
- Small to medium-sized machines
- Single-phase power supplies, switch-mode power supplies (SMPS)

For electrical schematic refer to page 3

Filter selection table

Filter	Rated current @ 40°C	Leakage current* @ 250 VAC/50 Hz (@ 120 VAC/60 Hz)	Inductance		Capacitance			Resistor R	Input connections	Output connections		Weight
			L1	L2	Cx	Cy1	Cy2			-	**	
-	[A]	[mA]	[mH]	[µH]	[µF]	[nF]	[nF]	[kΩ]				[g]
-	-	-	-	-	-	-	-	-	-	-	-	-
FN 9255 x-2-..	2	0.45 (0.26)	4.8	18	0.1	2.2	1	-	C14	-06	-07	52
FN 9255 x-4-..	4	0.45 (0.26)	2.1	18	0.1	2.2	1	-	C14	-06	-07	52
FN 9255 x-6-..	6	0.45 (0.26)	0.9	18	0.1	2.2	1	-	C14	-06	-07	52
FN 9255 x-10-..	10	0.45 (0.26)	0.2	18	0.1	2.2	1	-	C14	-06	-07	54
FN 9255 x-15-..	15	0.45 (0.26)	0.13	8	0.1	2.2	1	-	C14	-06	-07	54
FN 9255 x-16-..	16	0.45 (0.26)	0.3	0.7	0.1	2.2	1	-	C20	-06	-07	130
FN 9255 x-20-..	20	0.45 (0.26)	0.3	0.7	0.1	2.2	1	-	C20	-06	-07	130
FN 9255 xB-2-..	2	-	4.8	18	0.1	-	-	1000	C14	-06	-07	52
FN 9255 xB-4-..	4	-	2.1	18	0.1	-	-	1000	C14	-06	-07	52
FN 9255 xB-6-..	6	-	0.9	18	0.1	-	-	1000	C14	-06	-07	52
FN 9255 xB-10-..	10	-	0.2	18	0.1	-	-	1000	C14	-06	-07	54
FN 9255 xB-15-..	15	-	0.13	8	0.1	-	-	1000	C14	-06	-07	54
FN 9255 xB-16-..	16	-	0.3	0.7	0.1	-	-	1000	C20	-06	-07	130
FN 9255 xB-20-..	20	-	0.3	0.7	0.1	-	-	1000	C20	-06	-07	130
FN 9255 xR-2-..	2	0.45 (0.26)	4.8	18	0.1	-	-	1000	C14	-06	-07	52
FN 9255 xR-4-..	4	0.45 (0.26)	2.1	18	0.1	-	-	1000	C14	-06	-07	52
FN 9255 xR-6-..	6	0.45 (0.26)	0.9	18	0.1	-	-	1000	C14	-06	-07	52
FN 9255 xR-10-..	10	0.45 (0.26)	0.2	18	0.1	-	-	1000	C14	-06	-07	54
FN 9255 xR-15-..	15	0.45 (0.26)	0.13	8	0.1	-	-	1000	C14	-06	-07	54
FN 9255 xR-16-..	16	0.45 (0.26)	0.3	0.7	0.1	-	-	1000	C20	-06	-07	130
FN 9255 xR-20-..	20	0.45 (0.26)	0.3	0.7	0.1	-	-	1000	C20	-06	-07	130

Test conditions: 25°C±2°C; Measuring frequency for Inductance: 1 kHz; 50 mV;

Tolerances: Inductance: +50%, -30%; Capacitance: ±25%; Resistor: ±15%; For mechanical tolerances refer to mechanical data section.

** Maximum leakage under normal operating conditions (acc. to IEC60939-3). Note: if the neutral line is interrupted, worst case leakage could reach twice this level.

** Standard length is 100 mm

Product selector	
FN9255 wx -yy-..-(zz)	
Blank:	Snap-in range for S version only
20:	Snap-in range 0.7 to 1.5 mm
06:	Snap-in range 1.5 to 2.2 mm
07:	Faston 6.3 x 0.8 mm (spade/soldering)
07:	Wire leads
2 to 20:	Rated current
Blank:	Standard version
B:	Without Y-capacitors, with discharge resistors (Medical Version)
R:	With Y-capacitors, with discharge resistor
Blank:	Standard housing with mounting flanges (front mount)
M:	Standard housing with mounting flanges (rear mount)
S:	Snap-in version, snapper on vertical side

For example: FN 9255 MB-15-06 - FN 9255 dual stage IEC inlet with rear mount flanges, medical version, 15A rated current and fast-on terminals

Detailed electrical schematic

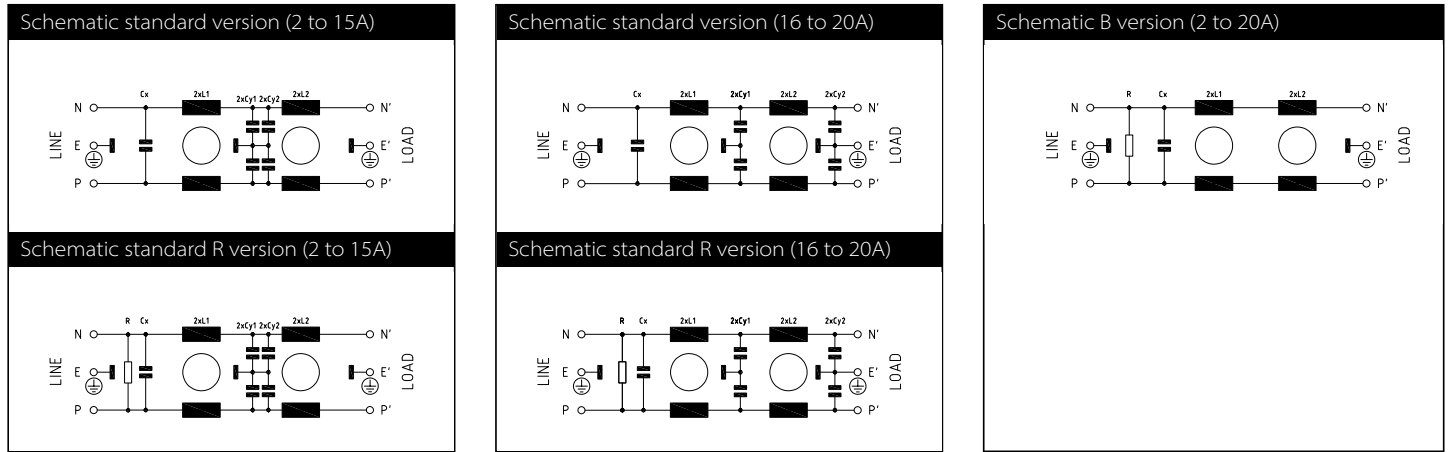

Typical filter attenuation

Per CISPR 17 - symmetrical 50 Ω/50 Ω - Differential Mode (DM) - asymmetrical 50 Ω/50 Ω - Common Mode (CM)

2 A (Standard Type)

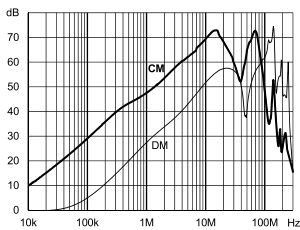

2 A (B Type)

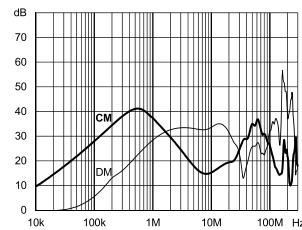

4 A (Standard Type)

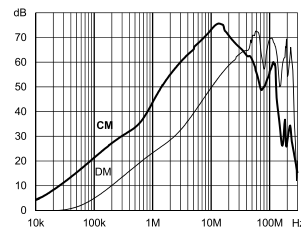

4 A (B Type)

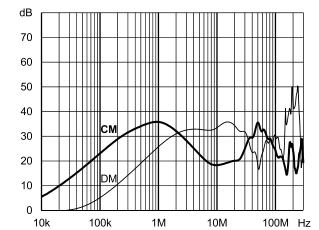

6 A (Standard Type)

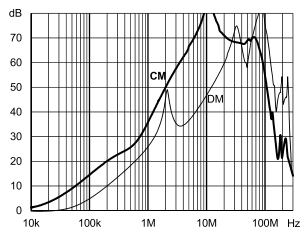

6 A (B Type)

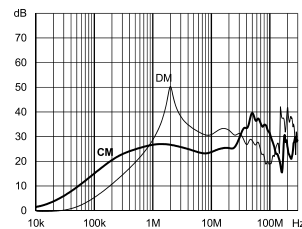

10 A (Standard Type)

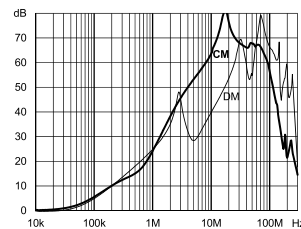

10 A (B Type)

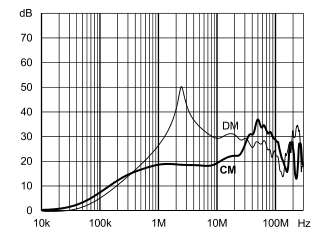

15 A (Standard Type)

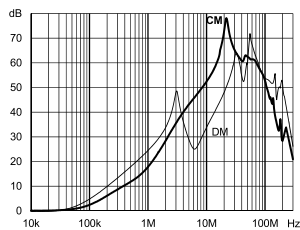

15 A (B Type)

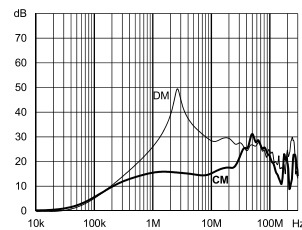

16 A (Standard Type)

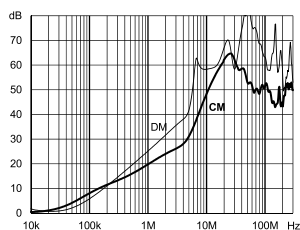

16 A (B Type)

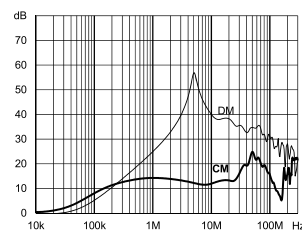

20 A (Standard Type)

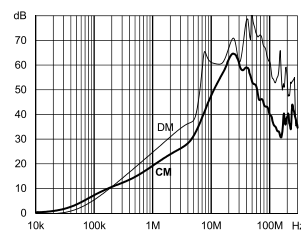

20 A (B Type)

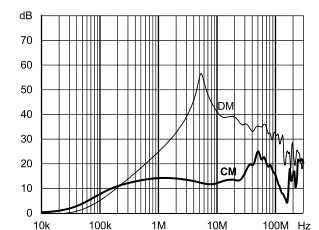

Mechanical data

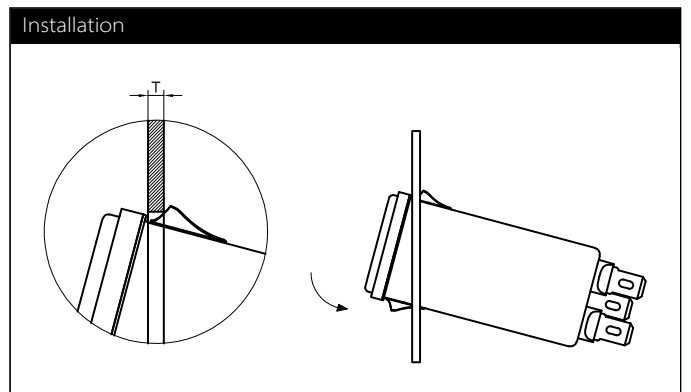
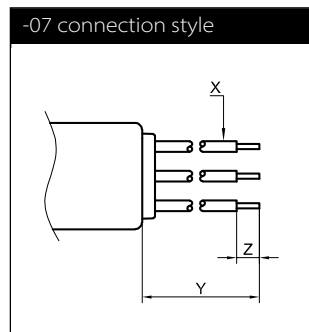
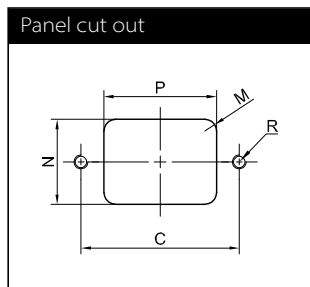
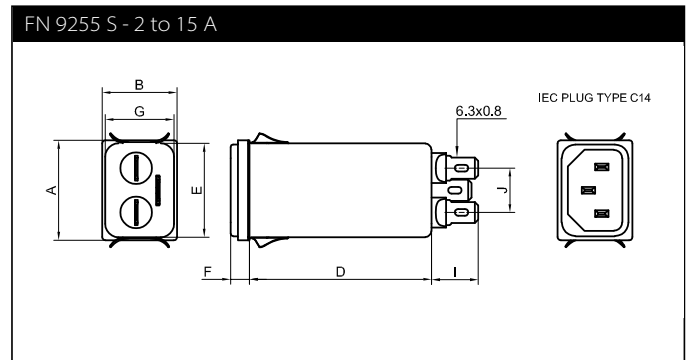
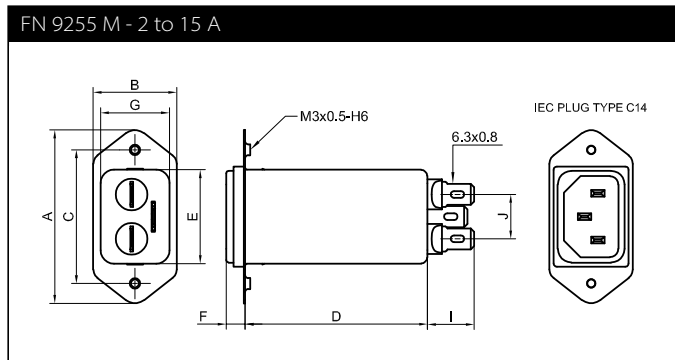
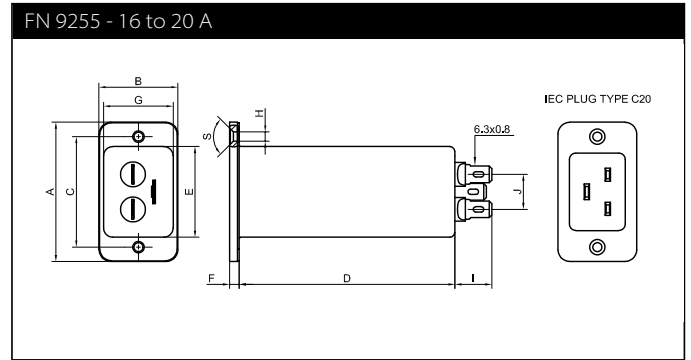
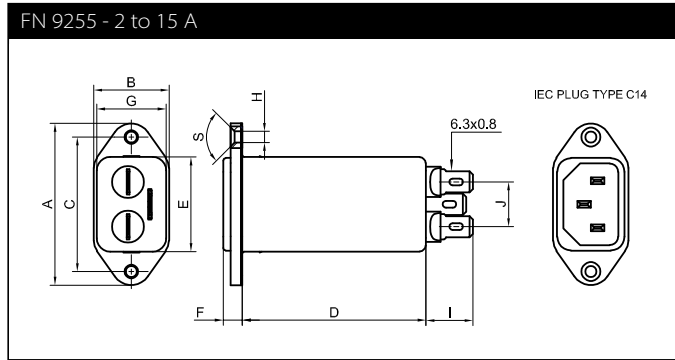

Dimensions

	FN 9255		FN 9255 M		FN 9255 S
	2 to 15A	16 to 20A			
A	48	53	51.85		29.9
B	22.4	30	25		22.4
C	40±0.2	42±0.2	40±0.2		-
D	-06: 54.5, -07: 52.5	82	-06: 54.5, -07: 52.5		-06: 54.5, -07: 52.5
E	28.1±0.3	34.6±0.3	28.1±0.3		28.1±0.3
F	5.8±0.2	3.9±0.2	5.8±0.2		5.8±0.2
G	20.6±0.3	26.7±0.3	20.6±0.3		20.6±0.3
H	Ø3.3	Ø3.5	M3		M3
I	14±0.5	14±0.5	14±0.5		14±0.5
J	13.3	13.3	13.3		13.3
M	R ≤ 3	R ≤ 3	R ≤ 1		R ≤ 1
N	21.5 +0.5/-0	27.1 +0.2/-0	22.9 +0.2/-0		21.0 +0.1/-0
P	28.5 +0.5/-0	34.9 +0.2/-0	30.4 +0.2/-0		29.5 +0.1/-0
R*	M3	M3	Ø3.4		Ø3.4
S	90°	90°			
T					1.5 - 2.2
X	AWG 18 (>6A: AWG 16)	AWG 14	AWG 18 (>6A: AWG 16)		AWG 18 (>6A: AWG 16)
Y	100±5	100±5	100±5		100±5
Z	6	6	6		6

* Recommended torque for M3 (90° countersunk flat head) is 0.5 Nm

All dimensions in mm; 1 inch = 25.4 mm

For values without dedicated tolerances ISO 2768-m/EN 22768-m applies.

Please visit www.schaffner.com to find more details on connectors.

Accessories

Power Cord with Locking System



- | Locking system for standardized IEC C14/C20 inlet filter

- | No accidental disconnection

- | Rated current up to 10 A (C13 plug), up to 15 A (C13P plug), and up to 16 A (C19 plug)

- | Fits any Schaffner IEC C14/C20 inlet filter

- | Retrofit for any IEC C14/C20 inlet

- | Various power line plugs for international usage

[Datasheet PDF >](#)

IL 13P IEC C13 Rewireable Angled Connectors with Locking System



- | Locking system for standardized IEC C14 inlet filter

- | No accidental disconnection

- | Rated current up to 15 A

- | Fits any Schaffner IEC C14 inlet filter

- | Retrofit for any IEC C14 inlet

- | Various power line plugs for international usage

[Datasheet PDF >](#)

Power Cord with angled Locking System C13



- | Locking system for standardized IEC C14 inlet filter

- | No accidental disconnection

- | Rated current up to 15 A

- | Fits any Schaffner IEC C14 inlet filter

- | Retrofit for any IEC C14 inlet

- | Various power line plugs for international usage

[Datasheet PDF >](#)