

High Performance Power Entry Module with Switch

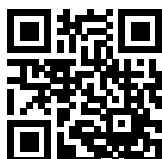

- Rated currents up to 10 A
- High quality 2-pole rocker switch
- Optional reduced leakage current versions (A/B type)
- Complies with IEC/EN 60601-1
- Snap-in versions (S type)
- High attenuation performance



Performance indicators

Attenuation performance



Rated current [A]

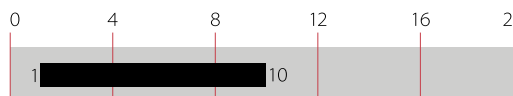

Approvals & Compliances



The FN 9266 power entry module combines an IEC inlet, mains filter with very high filter attenuation based on nano crystalline material selection and a switch in a small form factor. Choosing FN 9266 product line brings you rapid availability of a standard filter associated with the necessary safety acceptances. Standard IEC connector filters are a practical solution helping you to pass EMI system approval in a short time. A wide selection on amperage ratings, mounting possibilities and filters for medical applications (acc. to IEC 60601-1 with low leakage current and high performance) are designed to offer you the desired solution.

Features and Benefits

- Excellent conducted attenuation performance, based on chokes with high saturation resistance and good thermal behavior
- High quality 2-pole rocker switch for all-pole disconnection
- Faston terminals for easy assembly
- FN 9266 B versions comply with the requirements of 1MOP acc. to IEC/EN 60601-1 for creepage and clearance, leakage current and high potential testing
- As flange mount and snap-in types available

Technical Specifications

Operating voltage	250 VAC, 50/60 Hz
Operating frequency	DC to 400 Hz
Rated currents	1 to 10 A @ 40°C max.
High potential test voltage	P → PE 2000 VAC for 2 sec (Standard) P → PE 2500 VAC for 2 sec (B-types) P → N 760 VAC for 2 sec
Protection category	IP 40 according to IEC 60529
Temperature range (operation and storage)	-25°C to +85°C (25/85/21)
Design corresponding to	UL 60939-3, CSA Std C22.2 No. 8, IEC/EN 60939-3, GB/T 15287, GB/T 15288
Flammability corresponding to	Inlet plastic: UL 94 V-0 Switch plastic: UL 94 V-0
MTBF @ Rated amb. Temp./Voltage (Mil-HB-217F)	2,100,000 hours
Rocker switch description	
Function	2-pole, dark not illuminated Marking I – 0
Electrical specifications	Inrush current 100 A 50,000 on-off operations for 10 A according to EN 610581-1
Switch ratings	
Europe (ENEC)	10 A (4 A), 250 VAC* 5E4 16 A (4 A), 250 VAC* 1E4
USA (UL)	20 A, 125 VAC 1 HP; 250 VAC 2 HP;

Typical Applications

- Medical electrical devices (MD) and In-Vitro Diagnostic (IVD) medical devices
- Portable electrical and electronic equipment
- EDP and office equipment
- Single-phase power supplies
- Switch-mode power supplies
- Test and measurement equipment





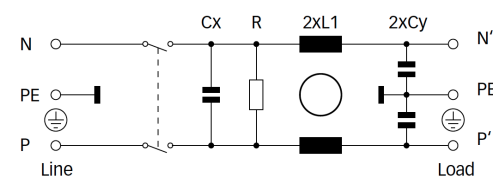











Typical electrical schematic

FN 9266 (B types without Y-capacitors)



* Value in () relates to the inductive current charge: $\cos\phi = 0.65$

Filter Selection Table

Filter	Buy	Rated current @ 40°C [A]	Leakage current* @ 250 VAC/50 Hz (@ 120 VAC/60 Hz) [mA]	Inductance** L [mH]	Capacitance**		Resistor** R [kΩ]	Output connections 	Weight [g]
					Cx [μF]	Cy [nF]			
FN9266-1-06		1	0.31 (0.18)	40	0.15	2.2	1000	-06	55
FN9266-2-06		2	0.31 (0.18)	20	0.15	2.2	1000	-06	55
FN9266-4-06		4	0.31 (0.18)	7	0.15	2.2	1000	-06	55
FN9266-6-06		6	0.31 (0.18)	3	0.15	2.2	1000	-06	55
FN9266-10-06		10	0.31 (0.18)	1.15	0.15	2.2	1000	-06	55
FN9266A-1-06		1	0.07 (0.04)	40	0.15	0.47	1000	-06	55
FN9266A-2-06		2	0.07 (0.04)	20	0.15	0.47	1000	-06	55
FN9266A-4-06		4	0.07 (0.04)	7	0.15	0.47	1000	-06	55
FN9266A-6-06		6	0.07 (0.04)	3	0.15	0.47	1000	-06	55
FN9266A-10-06		10	0.07 (0.04)	1.15	0.15	0.47	1000	-06	55
FN9266B-1-06		1	0.00	40	0.15		1000	-06	55
FN9266B-2-06		2	0.00	20	0.15		1000	-06	55
FN9266B-4-06		4	0.00	7	0.15		1000	-06	55
FN9266B-6-06		6	0.00	3	0.15		1000	-06	55
FN9266B-10-06		10	0.00	1.15	0.15		1000	-06	55

* Leakage current under normal operating conditions (acc. to IEC60939-3). Note: if the neutral line is interrupted, worst case leakage could reach twice this level.

** Tolerances apply: Inductance: -30/+50%, Capacitance: ±20%, Resistance: ±10%

Product selector

FN 9266xx-yy-yy-y

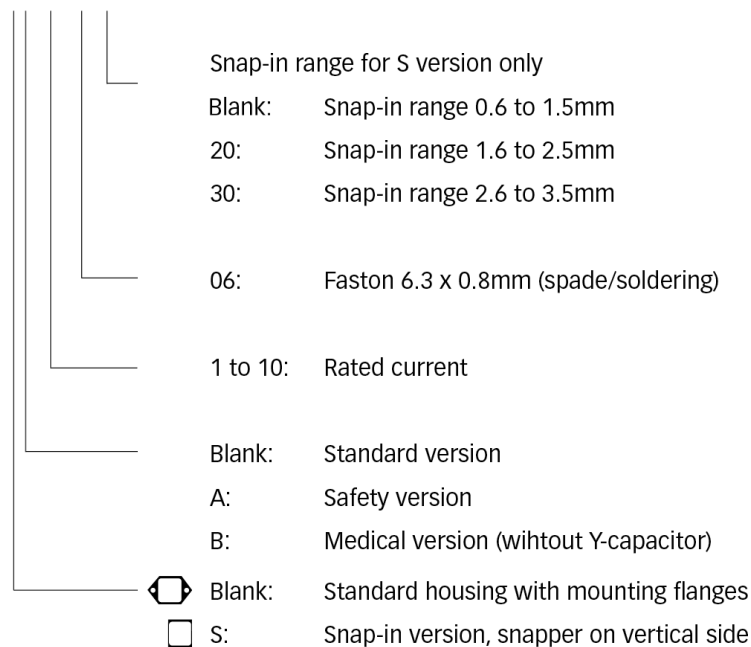

For example: FN 9266-1-06, FN 9266 SB-10-06

Typical Filter Attenuation

Per CISPR 17; DM (differential mode)=50 Ω/50 Ω sym; CM (common mode)=50 Ω/50 Ω asym

FN 9266 Standard Type 1 A

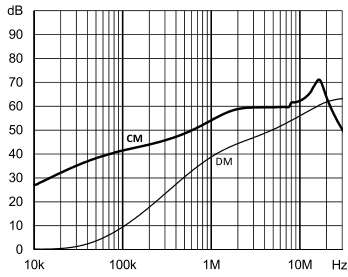

FN 9266 A Type 1 A

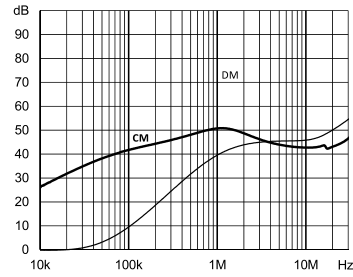

FN 9266 B Type 1 A

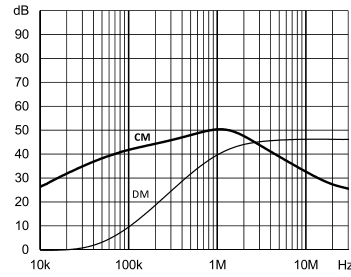

FN 9266 Standard Type 2 A

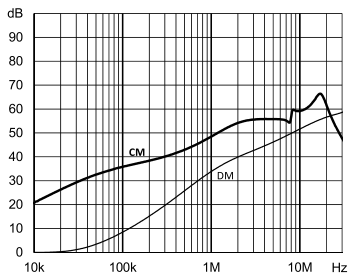

FN 9266 A Type 2 A

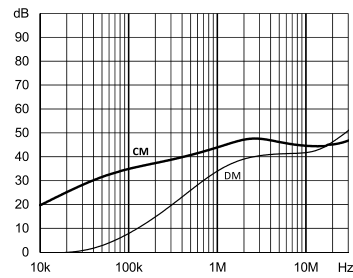

FN 9266 B Type 2 A

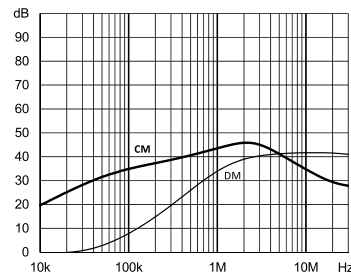

FN 9266 Standard Type 4 A

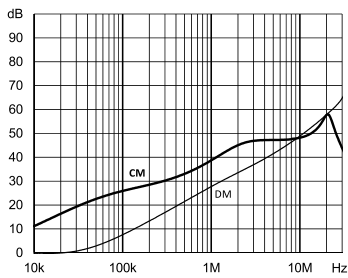

FN 9266 A Type 4 A

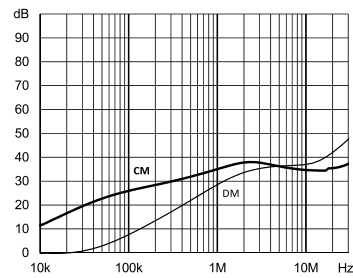

FN 9266 B Type 4 A

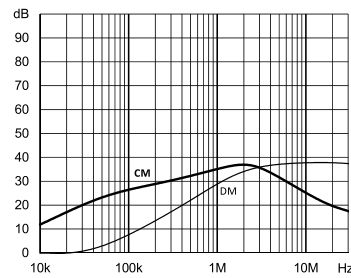

FN 9266 Standard Type 6 A

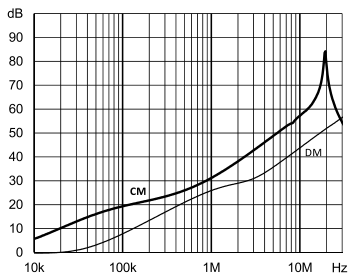

FN 9266 A Type 6 A

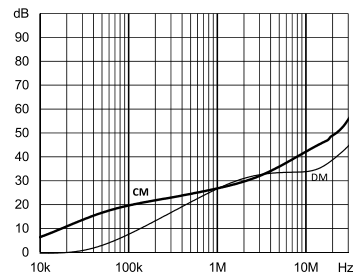

FN 9266 B Type 6 A

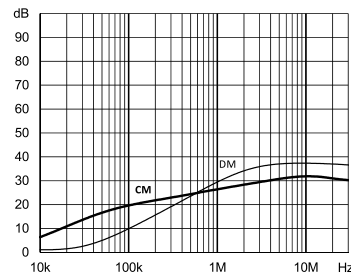

FN 9266 Standard Type 10 A

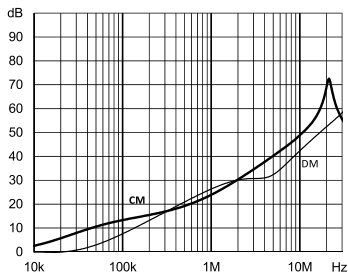

FN 9266 A Type 10 A

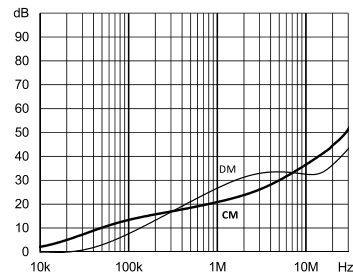

FN 9266 B Type 10 A

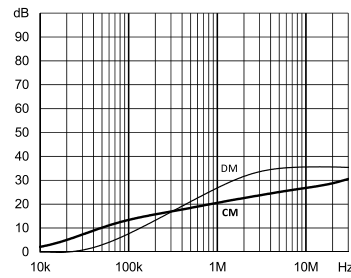

Mechanical Data

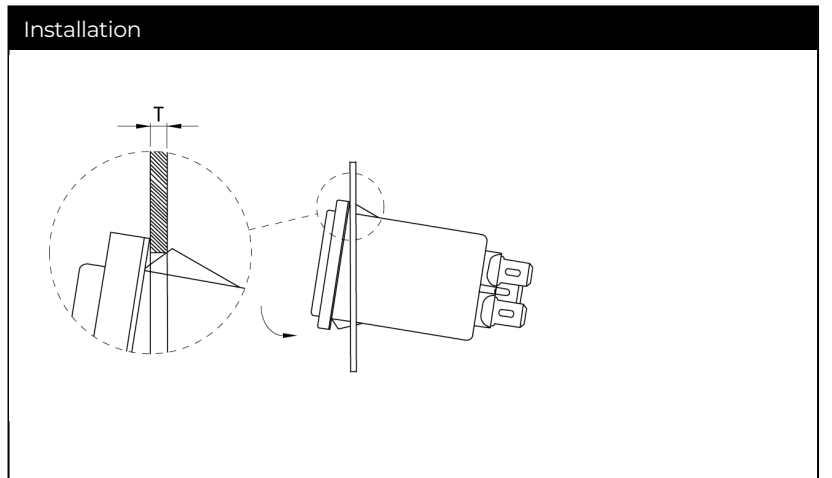
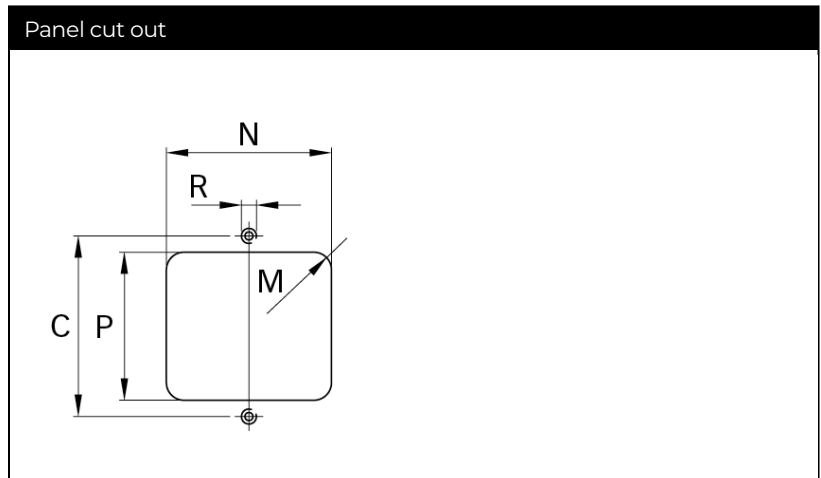
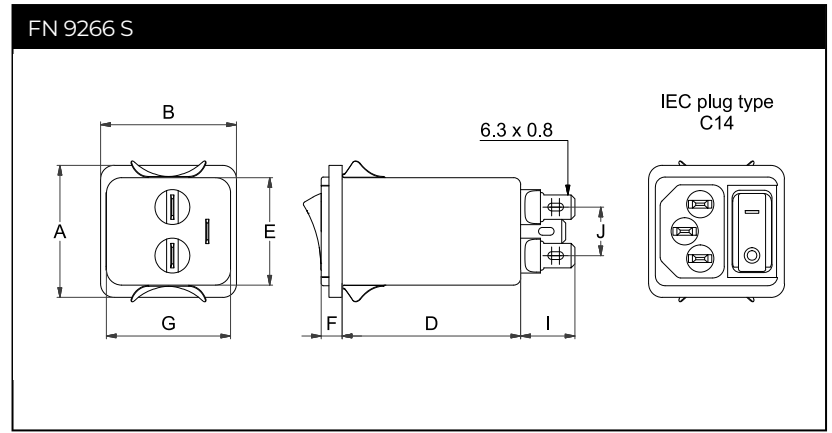
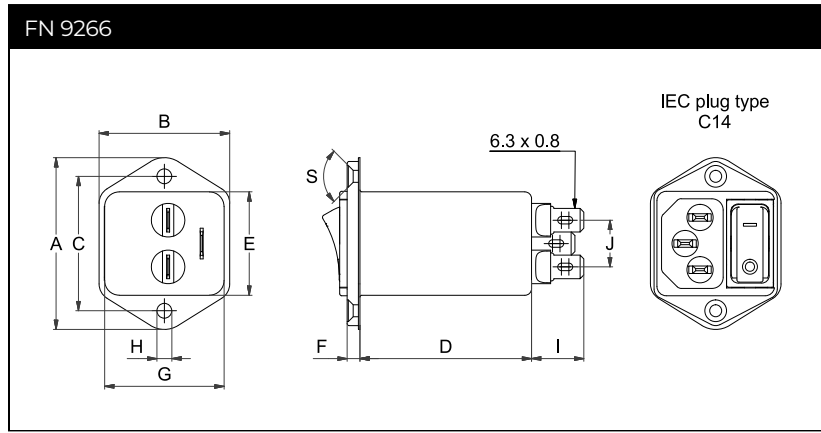

Dimensions

	FN 9266	FN 9266 S	Tolerances
A	46	34	±0.3
B	35	35	±0.3
C	36		±0.3
D	46	46	±0.3
E	27.8	27.8	+0.3/-0
F	5.5	5.5	±0.3
G	32	32	+0.3/-0
H	Ø3.2		±0.1
I	14	14	±0.5
J	12.5	12.5	±0.3
M	R ≤3.5	R ≤3.5	
N	33 +0.3/-0	33 +0.2/-0	
P	29 ±0.3	29.5 ±0.2	
R*	M3		
S	90°		
T**		0.6-1.5	
T**		1.6-2.5	
T**		2.6-3.5	

* Recommended torque for M3 (90° countersunk flat head) is 0.5 Nm

** For selecting the panel thickness, please refer to the filter selector table.

All dimensions in mm; 1 inch = 25.4 mm

Tolerances according: ISO 2768-m/EN 22768-m

Please visit www.schaffner.com to find more details on filter connections.

Accessories

IL 13P IEC C13 Rewireable Angled Connectors with Locking System



- Protects appliances that are vulnerable to vibration
- Connector cannot be accidentally pulled or vibrated out of the inlet
- Space availability/constraints
- Different angles for ease of access
- Space saving
- Release locking mechanism
- Prevents accidental disconnection

[Technical Data Sheet >](#)

IL 13P IEC C13 Rewireable Connectors with Locking System



The locking system has a tensile force of typical 300N. It is recommended to use it with flange mount filters. For details refer to our Application Note "Using IEC Lock Power Cords with IEC Inlets and Filters".

Schaffner power connector with IEC lock guard against accidental disconnection of all electrical appliances with an IEC inlet. No exchange or modification of the IEC inlet or IEC inlet filter system is needed. Easy retrofit for all electronic equipments and devices

[Technical Data Sheet >](#)

Power Cord with angled Locking System C13



- Protects appliances that are vulnerable to vibration
- Connector cannot be accidentally pulled or vibrated out of the inlet
- Space availability/constraints
- Different angles for ease of access
- Space saving
- Release locking mechanism
- Prevents accidental disconnection

[Technical Data Sheet >](#)