

# 6-Pin DIP High dv/dt Random Phase Triac Drivers

## FOD420, FOD4208, FOD4216, FOD4218

### Description

The FOD420, FOD4208, FOD4216 and FOD4218 devices consist of an infrared emitting diode coupled to a hybrid random phase triac formed with two inverse parallel SCRs which form the triac function capable of driving discrete triacs. The FOD4216 and FOD4218 utilize a high efficiency infrared emitting diode which offers an improved trigger sensitivity. These devices are housed in a standard 6-pin dual in-line (DIP) package.

### Features

- 300 mA<sub>peak</sub> On-State Current
- High Blocking Voltage
  - ◆ 600 V (FOD420, FOD4216)
  - ◆ 800 V (FOD4208, FOD4218)
- High Trigger Sensitivity
  - ◆ 1.3 mA (FOD4216, FOD4218)
  - ◆ 2 mA (FOD420, FOD4208)
- High Static dv/dt (10,000 V/μs)
- Safety and Regulatory Approvals:
  - ◆ UL1577, 5,000 VAC<sub>RMS</sub> for 1 Minute
  - ◆ DIN-EN/IEC60747-5-5
- These Devices are Pb-Free and are RoHS Compliant

### Applications

- Solid-State Relays
- Industrial Controls
- Lighting Controls
- Static Power Switches
- AC Motor Starters



**ON Semiconductor®**

[www.onsemi.com](http://www.onsemi.com)



**PDIP6 GW**  
CASE 709AG

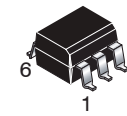

**PDIP6 7.3x6.5, 2.54P**  
CASE 646CE

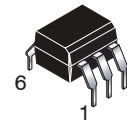

**PDIP6 7.3x6.5, 2.54P**  
CASE 646CF

### MARKING DIAGRAM



- ON = ON Semiconductor Logo
- FOD420 = Device Number
- V = VDE mark. DIN EN/IEC60747-5-5 Option (only appears on component ordered with this option)
- X = One-Digit Year Code
- YY = Digit Work Week
- D = Assembly Package Code

### FUNCTIONAL SCHEMATIC



### ORDERING INFORMATION

See detailed ordering and shipping information on page 8 of this data sheet.

**SAFETY AND INSULATION RATINGS**

Parameter		Characteristics
Installation Classifications per DIN VDE 0110/1.89 Table 1, For Rated Mains Voltage	< 150 V <sub>RMS</sub>	I-IV
	< 300 V <sub>RMS</sub>	I-IV
Climatic Classification		55/100/21
Pollution Degree (DIN VDE 0110/1.89)		2
Comparative Tracking Index		175

Symbol	Parameter	Value	Unit
V <sub>PR</sub>	Input-to-Output Test Voltage, Method A, V <sub>IORM</sub> × 1.6 = V <sub>PR</sub> , Type and Sample Test with t <sub>m</sub> = 10 s, Partial Discharge < 5 pC	1360	V <sub>peak</sub>
	Input-to-Output Test Voltage, Method B, V <sub>IORM</sub> × 1.875 = V <sub>PR</sub> , 100% Production Test with t <sub>m</sub> = 1 s, Partial Discharge < 5 pC	1594	V <sub>peak</sub>
V <sub>IORM</sub>	Maximum Working Insulation Voltage	850	V <sub>peak</sub>
V <sub>IOTM</sub>	Highest Allowable Over-Voltage	6000	V <sub>peak</sub>
	External Creepage	≥7	mm
	External Clearance	≥7	mm
DTI	Distance Through Insulation (Insulation Thickness)	≥0.4	mm
T <sub>S</sub>	Case Temperature (Note 1)	175	°C
I <sub>S,INPUT</sub>	Input Current (Note 1)	400	mA
P <sub>S,OUTPUT</sub>	Output Power (Note 1)	700	mW
R <sub>IO</sub>	Insulation Resistance at T <sub>S</sub> , V <sub>IO</sub> = 500 V (Note 1)	>10 <sup>9</sup>	Ω

As per DIN EN/IEC 60747-5-5, this optocoupler is suitable for “safe electrical insulation” only within the safety limit data. Compliance with the safety ratings shall be ensured by means of protective circuits.

1. Safety limit values – maximum values allowed in the event of a failure.

# FOD420, FOD4208, FOD4216, FOD4218

## ABSOLUTE MAXIMUM RATINGS (T<sub>A</sub> = 25°C, unless otherwise specified)

Symbol	Parameter	Device	Value	Unit
T <sub>STG</sub>	Storage Temperature	All	-55 to +150	°C
T <sub>OPR</sub>	Operating Temperature	All	-55 to +100	°C
T <sub>J</sub>	Junction Temperature	All	-55 to +125	°C
T <sub>SOL</sub>	Lead Solder Temperature	All	260 for 10 sec	°C
P <sub>D(TOTAL)</sub>	Total Device Power Dissipation @ 25°C	All	500	mW
	Derate Above 25°C	All	6.6	mW/°C

### EMITTER

I <sub>F</sub>	Continuous Forward Current	All	30	mA
V <sub>R</sub>	Reverse Voltage	All	6	V
P <sub>D(EMITTER)</sub>	Total Power Dissipation 25°C Ambient	All	50	mW
	Derate Above 25°C	All	0.71	mW/°C

### DETECTOR

V <sub>DRM</sub>	Off-State Output Terminal Voltage	FOD420, FOD4216	600	V
		FOD4208, FOD4218	800	
I <sub>TSM</sub>	Peak Non-Repetitive Surge Current (single cycle 60 Hz sine wave)	All	3	A <sub>peak</sub>
I <sub>TM</sub>	Peak On-State Current	All	300	mA <sub>peak</sub>
P <sub>D(DETECTOR)</sub>	Total Power Dissipation @ 25°C Ambient	All	450	mW
P <sub>D(DETECTOR)</sub>	Derate Above 25°C	All	5.9	mW/°C

Stresses exceeding those listed in the Maximum Ratings table may damage the device. If any of these limits are exceeded, device functionality should not be assumed, damage may occur and reliability may be affected.

# FOD420, FOD4208, FOD4216, FOD4218

## ELECTRICAL CHARACTERISTICS ( $T_A = 25^\circ\text{C}$ unless otherwise specified)

Symbol	Parameter	Test Condition	Device	Min	Typ	Max	Unit
--------	-----------	----------------	--------	-----	-----	-----	------

### INDIVIDUAL COMPONENT CHARACTERISTICS

Emitter								
$V_F$	Input Forward Voltage	$I_F = 20\text{ mA}$	All	–	1.28	1.50	V	
$I_R$	Reverse Leakage Current	$V_R = 6\text{ V}$	All	–	0.01	10	$\mu\text{A}$	
Detector								
$I_{D(RMS)}$	Peak Blocking Current, Either Direction	$I_F = 0$ , $T_A = 100^\circ\text{C}$ (Note 2)	$V_D = 600\text{ V}$	FOD420, FOD4216	–	3	100	$\mu\text{A}$
			$V_D = 800\text{ V}$	FOD4208, FOD4218				
$I_{R(RMS)}$	Reverse Current	$T_A = 100^\circ\text{C}$	$V_D = 600\text{ V}$	FOD420, FOD4216	–	3	100	$\mu\text{A}$
			$V_D = 800\text{ V}$	FOD4208, FOD4218				
dv/dt	Critical Rate of Rise of Off-State Voltage	$I_F = 0\text{ A}$ (Note 3)	$V_D = V_{DRM}$	All	10,000	–	–	V/ $\mu\text{s}$

### TRANSFER CHARACTERISTICS

$I_{FT}$	LED Trigger Current	Main Terminal Voltage = 5 V (Note 4)		FOD420, FOD4208	–	0.75	2.0	mA
				FOD4216, FOD4218				
$V_{TM}$	Peak On-State Voltage, Either Direction	$I_{TM} = 300\text{ mA peak}$ , $I_F = \text{Rated } I_{FT}$		All	–	2.2	3	V
$I_H$	Holding Current, Either Direction	$V_T = 3\text{ V}$		All	–	200	500	$\mu\text{A}$
$I_L$	Latching Current	$V_T = 2.2\text{ V}$		All	–	5	–	mA
$t_{ON}$	Turn-On Time	PF = 1.0, $I_T = 300\text{ mA}$	$V_{RM} = V_{DM} = 424\text{ VAC}$	FOD420, FOD4216, FOD4218	–	60	–	$\mu\text{s}$
			$V_{RM} = V_{DM} = 565\text{ VAC}$	FOD4208				
$t_{OFF}$	Turn-Off Time		$V_{RM} = V_{DM} = 424\text{ VAC}$	FOD420, FOD4216, FOD4218	–	52	–	$\mu\text{s}$
			$V_{RM} = V_{DM} = 565\text{ VAC}$	FOD4208				
dv/dt <sub>C</sub>	Critical Rate of Rise of Voltage at Current Commutation	$V_D = 230\text{ V}_{RMS}$ , $I_D = 300\text{ mA}_{PK}$		All	–	10	–	V/ $\mu\text{s}$
di/dt <sub>C</sub>	Critical Rate of Rise of On-State Current Commutation	$V_D = 230\text{ V}_{RMS}$ , $I_D = 300\text{ mA}_{PK}$		All	–	9	–	A/ms
dv(I <sub>O</sub> )/dt	Critical Rate of Rise of Coupled Input / Output Voltage	$I_T = 0\text{ A}$ , $V_{RM} = V_{DM} = 424\text{ VAC}$		All	10,000	–	–	V/ $\mu\text{s}$

### ISOLATION CHARACTERISTICS

$V_{ISO}$	Steady State Isolation Voltage	f = 60 Hz, t = 1 Minute (Note 5)	All	5,000	–	–	$\text{VAC}_{RMS}$
-----------	--------------------------------	----------------------------------	-----	-------	---	---	--------------------

Product parametric performance is indicated in the Electrical Characteristics for the listed test conditions, unless otherwise noted. Product performance may not be indicated by the Electrical Characteristics if operated under different conditions.

- Test voltage must be applied within dv/dt rating.
- This is static dv/dt. Commutating dv/dt is a function of the load-driving thyristor(s) only.
- All devices are guaranteed to trigger at an  $I_F$  value less than or equal to max  $I_{FT}$ . Therefore, recommended operating  $I_F$  lies between max  $I_{FT}$  (2 mA for FOD420 and FOD4208 and 1.3 mA for FOD4216 and FOD4218) and the absolute max  $I_F$  (30 mA).
- Isolation voltage,  $V_{ISO}$ , is an internal device dielectric breakdown rating. For this test, pins 1, 2 and 3 are common, and pins 4, 5 and 6 are common. 5,000  $\text{VAC}_{RMS}$  for 1 minute duration is equivalent to 6,000  $\text{VAC}_{RMS}$  for 1 second duration.

# FOD420, FOD4208, FOD4216, FOD4218

## TYPICAL APPLICATION

Figure 1 shows a typical circuit for when hot line switching is required. In this circuit the “hot” side of the line is switched and the load connected to the cold or neutral side. The load may be connected to either the neutral or hot line.

$R_{in}$  is calculated so that IF is equal to the rated IFT of the

part, 2 mA for FOD420 and FOD4208, 1.3 mA for FOD4216 and FOD4218. The 39  $\Omega$  resistor and 0.01  $\mu F$  capacitor are for snubbing of the triac and may or may not be necessary depending upon the particular triac and load use.



\*For highly inductive loads (power factor < 0.5), change this value to 360  $\Omega$ .

**Figure 1. Hot-Line Switching Application Circuit**



**Figure 2. Inverse-Parallel SCR Driver Circuit**

Suggested method of firing two, back-to-back SCR's with On Semiconductor triac driver. Diodes can be 1N4001; resistors, R1 and R2, are optional 330  $\Omega$ .

**NOTE:** This optoisolator should not be used to drive a load directly. It is intended to be a discrete triac driver device only.

TYPICAL CHARACTERISTICS

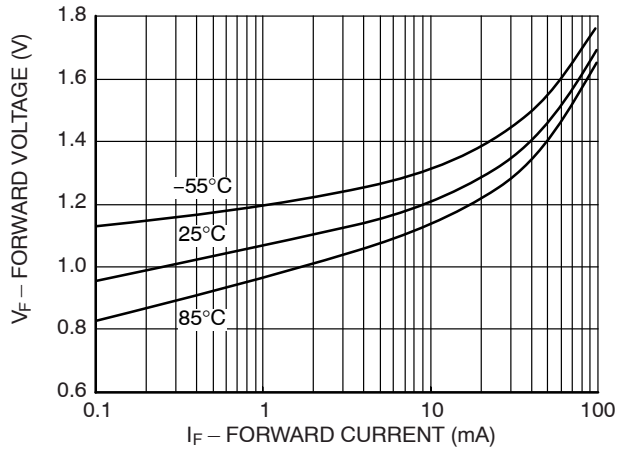

Figure 3. Forward Voltage ( $V_F$ ) vs. Forward Current ( $I_F$ )

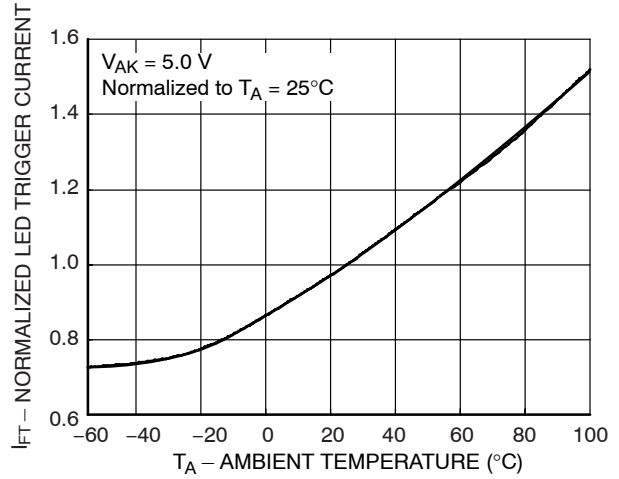

Figure 4. Normalized LED Trigger Current ( $I_{FT}$ ) vs. Ambient Temperature ( $T_A$ )

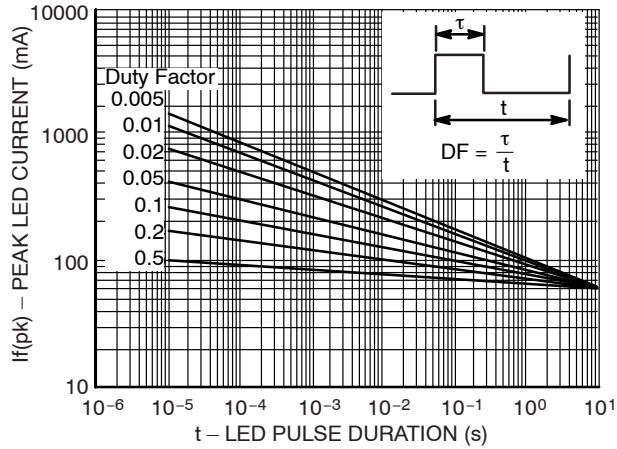

Figure 5. Peak LED Current vs. Duty Factor, Tau

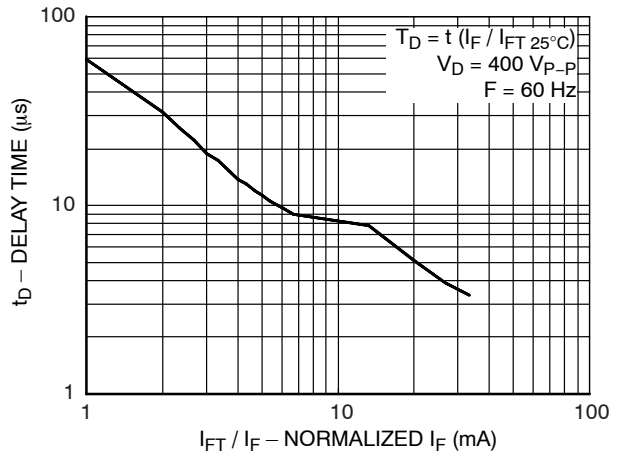

Figure 6. Trigger Delay Time

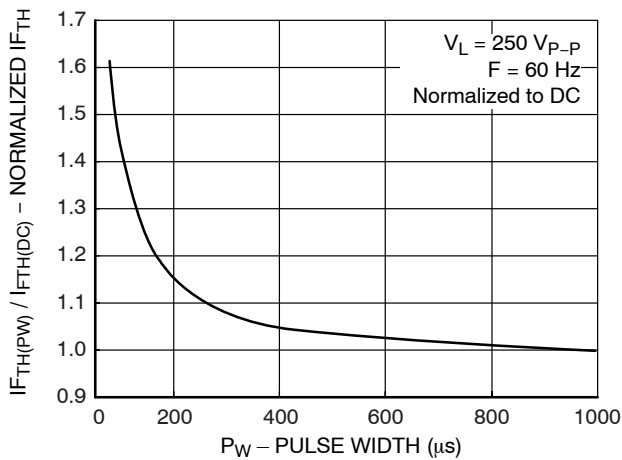

Figure 7. Pulse Trigger Current

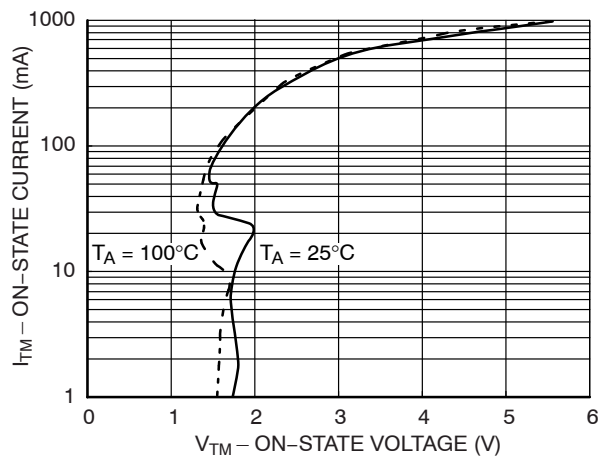

Figure 8. On-State Voltage ( $V_{TM}$ ) vs. On-State Current ( $I_{TM}$ )

TYPICAL CHARACTERISTICS (continued)



Figure 9. Normalized Holding Current ( $I_H$ ) vs. Ambient Temperature ( $T_A$ )

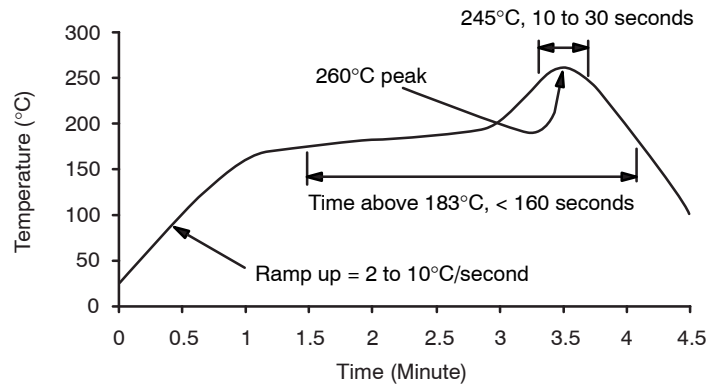

Figure 10. Normalized Off-State Current ( $I_{DRM}$ ) vs. Ambient Temperature ( $T_A$ )



Figure 11. Current Reduction

REFLOW PROFILE



- Peak reflow temperature: 262°C (package surface temperature)
- Time of temperature higher than 183°C for 160 seconds or less
- One time soldering reflow is recommended

Figure 12. Reflow Profile

ORDERING INFORMATION

Part Number	Package	Shipping†
FOD420	DIP 6-Pin	50 Units / Tube
FOD420S	SMT 6-Pin (Lead Bend)	50 Units / Tube
FOD420SD	SMT 6-Pin (Lead Bend)	1000 / Tape & Reel
FOD420V	DIP 6-Pin, DIN EN/IEC60747-5-5 Option	50 Units / Tube
FOD420SV	SMT 6-Pin (Lead Bend), DIN EN/IEC60747-5-5 Option	50 Units / Tube
FOD420SDV	SMT 6-Pin (Lead Bend), DIN EN/IEC60747-5-5 Option	1000 / Tape & Reel
FOD420TV	DIP 6-Pin, 0.4" Lead Spacing, DIN EN/IEC60747-5-5 Option	50 Units / Tube

†For information on tape and reel specifications, including part orientation and tape sizes, please refer to our Tape and Reel Packaging Specifications Brochure, BRD8011/D.

6. The product orderable part number system listed in this table also applies to the FOD4208, FOD4216, and FOD4218 product families.



**MECHANICAL CASE OUTLINE**  
**PACKAGE DIMENSIONS**

ON Semiconductor®



**PDIP6 7.3x6.5, 2.54P**  
CASE 646CE  
ISSUE O

DATE 31 JUL 2016

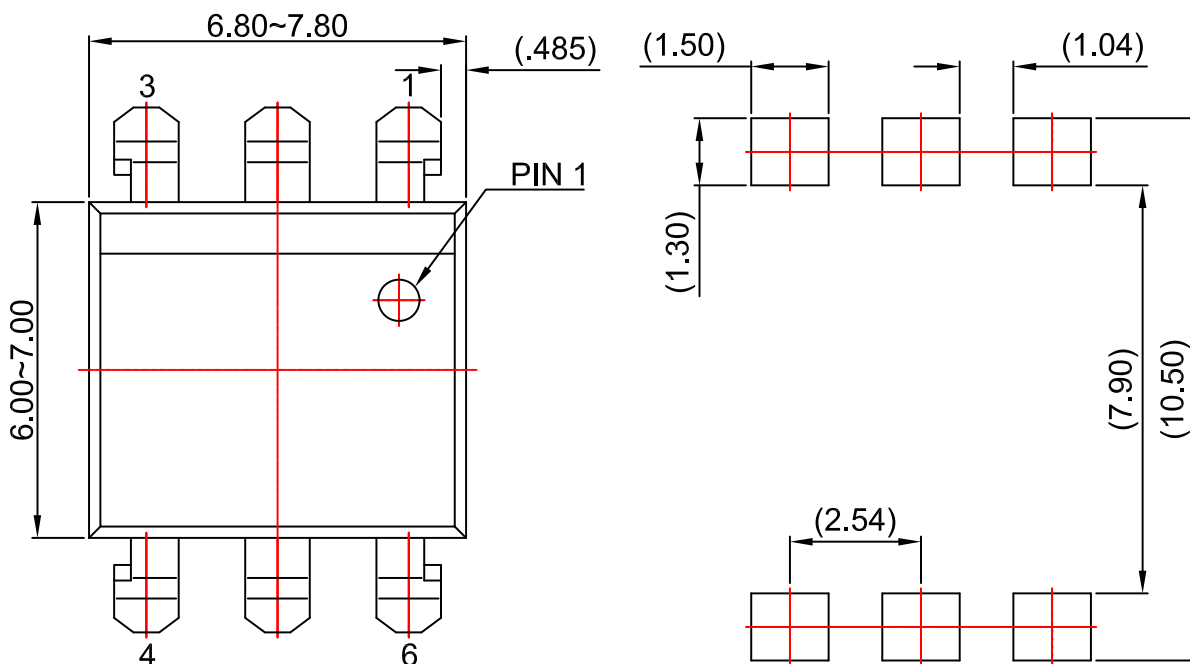

**LAND PATTERN RECOMMENDATION**

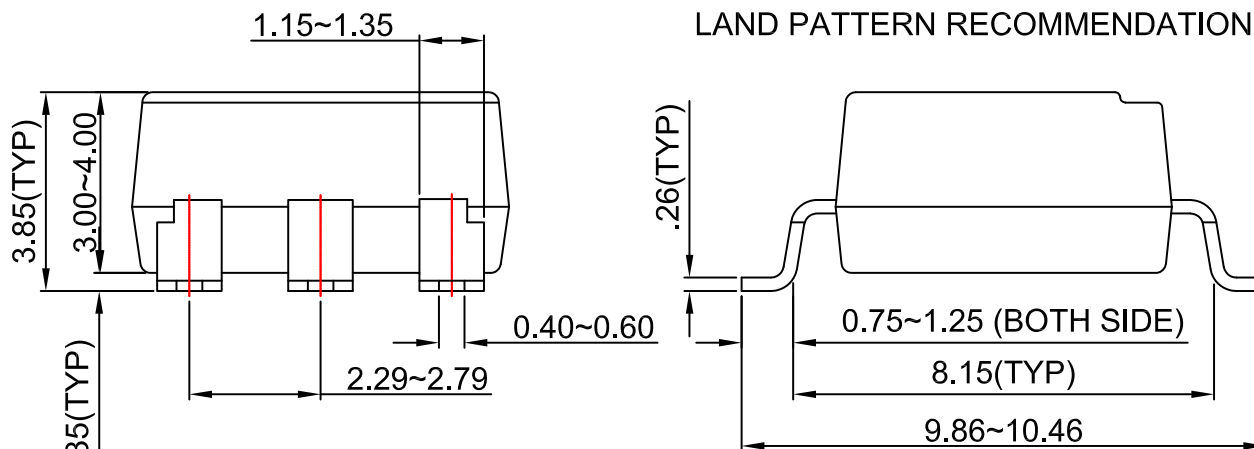

**NOTES:**

- A) NO STANDARD APPLIES TO THIS PACKAGE.
- B) ALL DIMENSIONS ARE IN MILLIMETERS.
- C) DIMENSIONS ARE EXCLUSIVE OF BURRS, MOLD FLASH, AND TIE BAR EXTRUSION

<b>DOCUMENT NUMBER:</b>	<b>98AON13456G</b>	Electronic versions are uncontrolled except when accessed directly from the Document Repository. Printed versions are uncontrolled except when stamped "CONTROLLED COPY" in red.
<b>DESCRIPTION:</b>	<b>PDIP6 7.3X6.5, 2.54P</b>	<b>PAGE 1 OF 1</b>

ON Semiconductor and are trademarks of Semiconductor Components Industries, LLC dba ON Semiconductor or its subsidiaries in the United States and/or other countries. ON Semiconductor reserves the right to make changes without further notice to any products herein. ON Semiconductor makes no warranty, representation or guarantee regarding the suitability of its products for any particular purpose, nor does ON Semiconductor assume any liability arising out of the application or use of any product or circuit, and specifically disclaims any and all liability, including without limitation special, consequential or incidental damages. ON Semiconductor does not convey any license under its patent rights nor the rights of others.

# MECHANICAL CASE OUTLINE

## PACKAGE DIMENSIONS

ON Semiconductor®



**PDIP6 7.3x6.5, 2.54P**  
CASE 646CF  
ISSUE O

DATE 31 JUL 2016



**NOTES:**

- A) NO STANDARD APPLIES TO THIS PACKAGE.
- B) ALL DIMENSIONS ARE IN MILLIMETERS.
- C) DIMENSIONS ARE EXCLUSIVE OF BURRS, MOLD FLASH, AND TIE BAR EXTRUSION

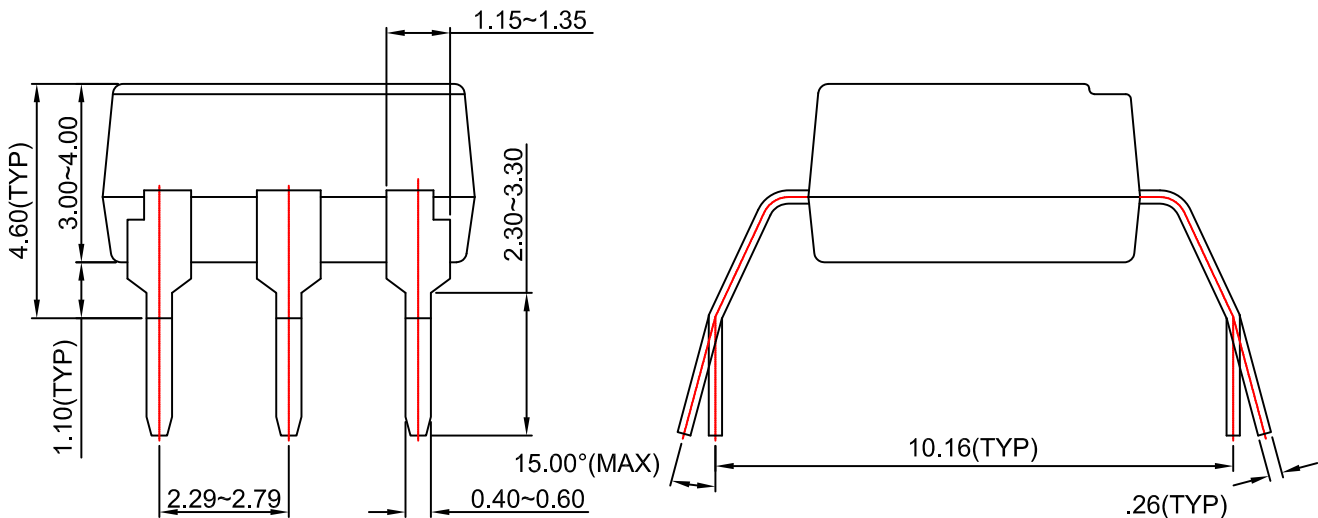

<b>DOCUMENT NUMBER:</b>	<b>98AON13457G</b>	Electronic versions are uncontrolled except when accessed directly from the Document Repository. Printed versions are uncontrolled except when stamped "CONTROLLED COPY" in red.
<b>DESCRIPTION:</b>	<b>PDIP6 7.3X6.5, 2.54P</b>	<b>PAGE 1 OF 1</b>

ON Semiconductor and are trademarks of Semiconductor Components Industries, LLC dba ON Semiconductor or its subsidiaries in the United States and/or other countries. ON Semiconductor reserves the right to make changes without further notice to any products herein. ON Semiconductor makes no warranty, representation or guarantee regarding the suitability of its products for any particular purpose, nor does ON Semiconductor assume any liability arising out of the application or use of any product or circuit, and specifically disclaims any and all liability, including without limitation special, consequential or incidental damages. ON Semiconductor does not convey any license under its patent rights nor the rights of others.

# MECHANICAL CASE OUTLINE

## PACKAGE DIMENSIONS

ON Semiconductor®



**PDIP6 GW**  
CASE 709AG  
ISSUE A

DATE 31 JUL 2016

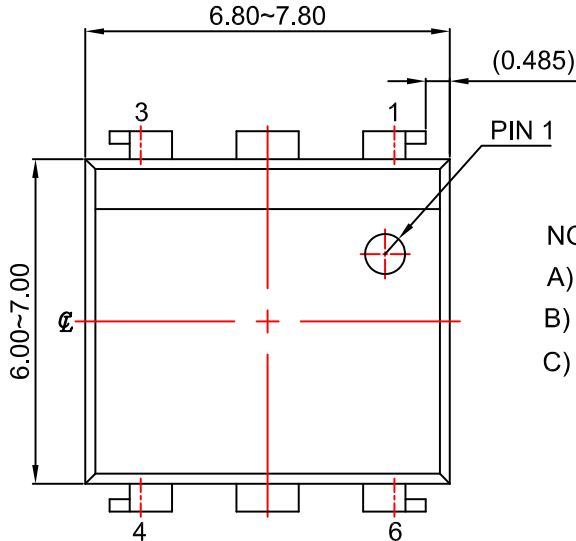

**NOTES:**

- A) NO STANDARD APPLIES TO THIS PACKAGE.
- B) ALL DIMENSIONS ARE IN MILLIMETERS.
- C) DIMENSIONS ARE EXCLUSIVE OF BURRS, MOLD FLASH, AND TIE BAR EXTRUSION

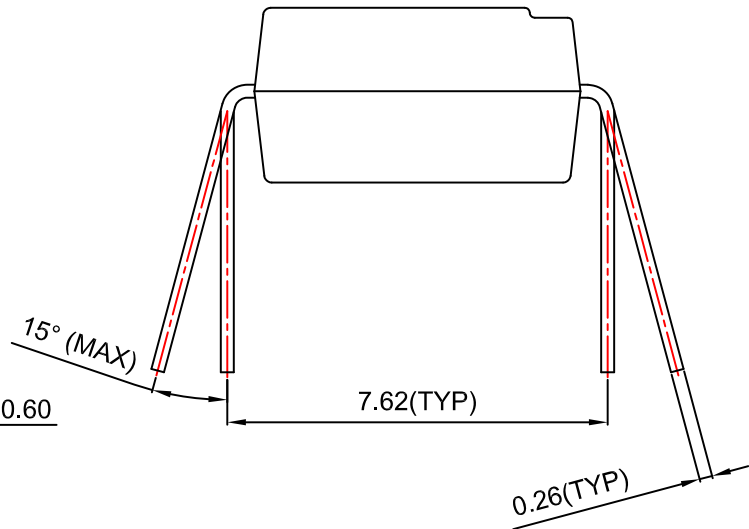
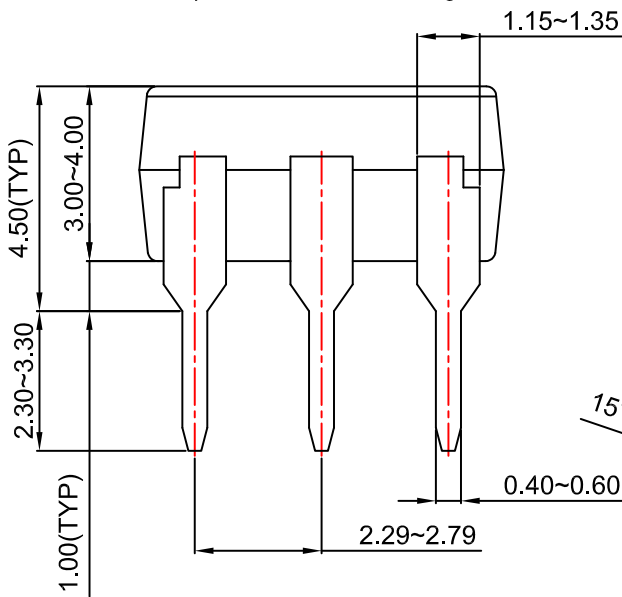

<b>DOCUMENT NUMBER:</b>	<b>98AON13455G</b>	Electronic versions are uncontrolled except when accessed directly from the Document Repository. Printed versions are uncontrolled except when stamped "CONTROLLED COPY" in red.
<b>DESCRIPTION:</b>	<b>PDIP6 GW</b>	<b>PAGE 1 OF 1</b>

ON Semiconductor and are trademarks of Semiconductor Components Industries, LLC dba ON Semiconductor or its subsidiaries in the United States and/or other countries. ON Semiconductor reserves the right to make changes without further notice to any products herein. ON Semiconductor makes no warranty, representation or guarantee regarding the suitability of its products for any particular purpose, nor does ON Semiconductor assume any liability arising out of the application or use of any product or circuit, and specifically disclaims any and all liability, including without limitation special, consequential or incidental damages. ON Semiconductor does not convey any license under its patent rights nor the rights of others.