

# FOD8480, FOD8482

## Optically Isolated Intelligent Power Module (IPM) Driver in Stretched Body SOP 6-Pin

### Description

The FOD8480 and FOD8482 are low power optocouplers, which support isolated interface to Intelligent Power Module (IPM) communicating digital control signals from the controller to the IPM, without conducting ground loops or hazardous voltages.

The FOD848x Series, packaged in a stretched body 6-pin small outline plastic package, consists of an aluminum gallium arsenide (AlGaAs) light emitting diode and an integrated high gain photo detector. The detector has a detector threshold with hysteresis. The hysteresis provides differential mode noise immunity and eliminates the potential for output signal chatter. Its non-inverting output is designed as totem pole, which does not require any pull-up resistor.

The FOD8482 has a lower threshold input current,  $I_{FLH}$ , at 3.0 mA maximum. For the complete FOD848x Series, the Electrical and Switching Characteristics are guaranteed over the extended industrial temperature range of  $-40^{\circ}\text{C}$  to  $100^{\circ}\text{C}$  and a  $V_{DD}$  range of 4.5 V to 30 V. Low  $I_F$  and wide  $V_{DD}$  range allow compatibility with TTL, LSTTL, and CMOS logic and result in lower power consumption compared to other high speed optocouplers.

### Features

- Maximum Threshold Input Current,  $I_{FLH}$ 
  - ◆ FOD8480 – 5.5 mA
  - ◆ FOD8482 – 3.0 mA
- FOD8480T and FOD8482T – 8 mm Creepage and Clearance Distance, and 0.4 mm Insulation Distance to Achieve Reliable and High Voltage Insulation
- High Noise Immunity Characterized by Common Mode Transient Immunity (CMTI)
- 20 kV/ $\mu\text{s}$  Minimum CMTI
- Wide Operating Voltage Range, 4.5 V to 30 V
- Specifications Guaranteed Over Extended Industrial Temperature Range,  $-40$  to  $100^{\circ}\text{C}$
- Safety and Regulatory Approvals
  - ◆ UL1577, 5,000 VAC<sub>RMS</sub> for 1 Min.
  - ◆ DIN-EN/IEC60747-5-5, 1,140 V Peak Working Insulation Voltage

### Typical Applications

- Isolating Intelligent Power Module
- Isolating Industrial Communication Interface



ON Semiconductor®

[www.onsemi.com](http://www.onsemi.com)

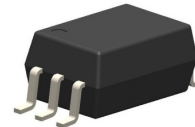

SOIC6  
SUFFIX  
CASE 751EL

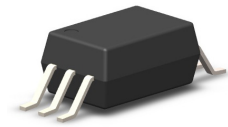

SOIC6 W  
SUFFIX  
CASE 751EM

### MARKING DIAGRAM

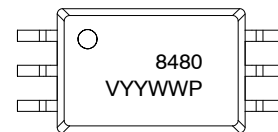

8480 or 8482 = Specific Device Number  
V = DIN EN/IEC60747-5-5 Option  
YY = Two Digit Year Code  
WW = Two Digit Work Week  
P = Assembly Package Code

### PIN CONNECTIONS

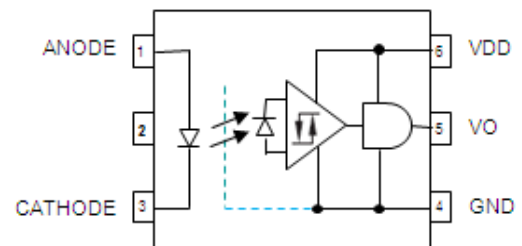

### TRUTH TABLE

LED	$V_o$
Off	Low
On	High

### ORDERING INFORMATION

See detailed ordering, marking and shipping information in the package dimensions section on page 10 of this data sheet.

## FOD8480, FOD8482

**Table 1. SAFETY AND INSULATION RATINGS for Stretched Body SOP 6-Pin**

As per DIN EN/IEC60747-5-5. This optocoupler is suitable for "safe electrical insulation" only within the safety limit data. Compliance with the safety ratings shall be ensured by means of protective circuits.

Parameter	Symbol	FOD8480 FOD8482	FOD8480T FOD8482T	Unit
Installation Classifications per DIN VDE 0110/1.89 Table 1, for rated main voltage <150 Vrms		I-IV	I-IV	
for rated main voltage <300 Vrms		I-IV	I-IV	
for rated main voltage <450 Vrms		I-III	I-IV	
for rated main voltage <600 Vrms		I-III	I-III	
Climatic Classification		40/100/21	40/100/21	
Pollution Degree (DIN VDE 0110/1.89)		2	2	
Comparative Tracking Index	CTI	175	175	
Input to Output Test Voltage, Method b, VIORM*1.875=VPR, 100% Production Test with tm=1 sec, Partial Discharge <5 pC	VPR	1,671	2,137	Vpeak
Input to Output Test Voltage, Method a, VIORM*1.6 = VPR, Type and Sample Test with tm = 10 sec, Partial Discharge <5 pC	VPR	1,426	1,824	Vpeak
Max Working Insulation Voltage	VIORM	891	1,140	Vpeak
Highest Allowable Over Voltage	VIOTM	6,000	8,000	Vpeak
External Clearance		7.0	8.0	mm
External Creepage		8.0	8.0	mm
Insulation thickness		0.4	0.4	mm
Insulation Resistance at Ts, VIO = 500 V	RIO	10 <sup>9</sup>	10 <sup>9</sup>	Ω
Safety Limit Values- Maximum Values allowed in the event of a failure,				
Case Temperature	Ts	150	150	°C
Input Current	IS,INPUT	200	200	mA
Output Power	PS,OUTPUT	600	600	mW

# FOD8480, FOD8482

**Table 2. ABSOLUTE MAXIMUM RATINGS** ( $T_A = 25^\circ\text{C}$  unless otherwise specified)

Symbol	Parameter	Value	Units
$T_{STG}$	Storage Temperature	-40 to +125	$^\circ\text{C}$
$T_{OPR}$	Operating Temperature	-40 to +100	$^\circ\text{C}$
$T_J$	Junction Temperature	-40 to +125	$^\circ\text{C}$
$T_{SOL}$	Lead Solder Temperature (Refer to Reflow Temperature Profile)	260 for 10 sec	$^\circ\text{C}$

## INPUT CHARACTERISTICS

$I_F$	Average Forward Input Current	20	mA
$V_R$	Reverse Input Voltage	5.0	V
$PD_I$	Input Power Dissipation (Notes 1, 3)	35	mW

## OUTPUT CHARACTERISTICS

$V_{DD}$	Supply Voltage	0 to 35	V
$V_O$	Output Voltage	-0.5 to $V_{DD}$	V
$I_O$	Average Output Current	25	mA
$PD_O$	Output Power Dissipation (Notes 2, 3)	300	mW

Stresses exceeding those listed in the Maximum Ratings table may damage the device. If any of these limits are exceeded, device functionality should not be assumed, damage may occur and reliability may be affected.

**Table 3. RECOMMENDED OPERATING CONDITIONS**

Symbol	Parameter	Min	Max	Unit
$T_A$	Ambient Operating Temperature	-40	+100	$^\circ\text{C}$
$V_{DD}$	Supply Voltages (Note 4)	4.5	30	V
$V_{F(OFF)}$	Forward Input Voltage (OFF)	0	0.8	V
$I_{F(ON)}$	Forward Input Current (ON) (Note 5)	6.6	10	mA
		3.6	7.5	mA

Functional operation above the stresses listed in the Recommended Operating Ranges is not implied. Extended exposure to stresses beyond the Recommended Operating Ranges limits may affect device reliability.

1. No derating required across operating temperature range.
2. Derate linearly from  $25^\circ\text{C}$  at a rate of  $2.87\text{ mW}/^\circ\text{C}$ .
3. Functional operation under these conditions is not implied. Permanent damage may occur if the device is subjected to conditions outside these ratings.
4.  $0.1\ \mu\text{F}$  bypass capacitor must be connected between Pin 4 and 6.
5. For FOD8480, the initial switching threshold is 5.5 mA or less. It is recommended that 6.6 mA be used to permit at least a 20% CTR degradation guard band. For FOD8482, the initial switching threshold is 3.0 mA or less. It is recommended that 3.6 mA be used to permit at least a 20% CTR degradation guard band.

**Table 4. ISOLATION CHARACTERISTICS** (Apply over all recommended conditions, typical value is measured at  $T_A = 25^\circ\text{C}$ )

Symbol	Parameter	Conditions	Min	Typ	Max	Units
$V_{ISO}$	Input-Output Isolation Voltage	$T_A = 25^\circ\text{C}$ , R.H. < 50%, $t = 1.0\text{ min}$ , $I_{I-O} \leq 2\ \mu\text{A}$ (Notes 6, 7)	5,000			VAC <sub>RMS</sub>
$R_{ISO}$	Isolation Resistance	$V_{I-O} = 500\text{ V}$ (Note 6)		$10^{11}$		$\Omega$
$C_{ISO}$	Isolation Capacitance	$V_{I-O} = 0\text{ V}$ , freq = 1.0 MHz (Note 6)		1.0		pF

6. Device is considered a two terminal device: Pins 1, 2 and 3 are shorted together and Pins 4, 5, and 6 are shorted together.
7. 5,000 VAC<sub>RMS</sub> for 1 minute duration is equivalent to 6,000 VAC<sub>RMS</sub> for 1 second duration.

## FOD8480, FOD8482

**Table 5. ELECTRICAL CHARACTERISTICS** (Apply over all recommended conditions,  $T_A = -40^{\circ}\text{C}$  to  $+100^{\circ}\text{C}$ ,  $4.5\text{ V} \leq V_{DD} \leq 30\text{ V}$ , FOD8480:  $I_{F(ON)} = 6\text{ mA}$  to  $10\text{ mA}$ , FOD8482:  $I_{F(ON)} = 4\text{ mA}$  to  $7\text{ mA}$ ,  $V_{F(OFF)} = 0$  to  $0.8\text{ V}$ , unless otherwise specified. Typical value is measured at  $T_A = 25^{\circ}\text{C}$  and  $V_{DD} = 5\text{ V}$ .)

Symbol	Parameter	Conditions	Min	Typ	Max	Units
<b>INPUT CHARACTERISTICS</b>						
$V_F$	Forward Voltage	$I_F = 6\text{ mA}$		1.4	1.75	V
$BV_R$	Reverse Breakdown Voltage	$I_R = 10\text{ }\mu\text{A}$	5.0			V
$C_{IN}$	Input Capacitance	$V_F = 0$ , $f = 1\text{ MHz}$		60		pF
$\Delta V_F/\Delta T_A$	Input Diode Temperature Coefficient	$I_F = 6\text{ mA}$		-1.4		mV/ $^{\circ}\text{C}$
$I_{FLH}$	Threshold Input Current Low to High	FOD8480		2.2	5.5	mA
		FOD8482		1.45	3.0	mA
$I_{HYS}$	Input Current Hysteresis	$V_{DD} = 5\text{ V}$		0.3		mA

### OUTPUT CHARACTERISTICS

$I_{DDH}$	Logic High Output Supply Current	$V_{DD} = 5\text{ V}$ , $I_F = 10\text{ mA}$		1.6	2.5	mA
		$V_{DD} = 30\text{ V}$ , $I_F = 10\text{ mA}$		1.8	2.5	mA
$I_{DDL}$	Logic Low Output Supply Current	$V_{DD} = 5\text{ V}$ , $I_F = 0\text{ mA}$		1.6	2.5	mA
		$V_{DD} = 30\text{ V}$ , $I_F = 0\text{ mA}$		1.8	2.5	mA
$I_{OSH}$	Logic High Short Circuit Output Current	$V_{DD} = 5.5\text{ V}$ , $I_F = 10\text{ mA}$ , $V_O = \text{GND}$			-80	mA
		$V_{DD} = 30\text{ V}$ , $I_F = 10\text{ mA}$ , $V_O = \text{GND}$			-80	mA
$I_{OSL}$	Logic Low Short Circuit Output Current	$V_{DD} = V_O = 5.5\text{ V}$ , $V_F = 0\text{ V}$	80			mA
		$V_{DD} = V_O = 30\text{ V}$ , $V_F = 0\text{ V}$	80			mA
$V_{OH}$	Logic High Output Voltage	$I_{OH} = -2.6\text{ mA}$	$V_{DD} - 0.1$	$V_{DD} - 0.04$		V
		$I_{OH} = -0.4\text{ mA}$	$V_{DD} - 0.1$	$V_{DD} - 0.01$		V
$V_{OL}$	Logic Low Output Voltage	$I_{OL} = 6.4\text{ mA}$ , $V_F = 0\text{ V}$			0.5	V

Product parametric performance is indicated in the Electrical Characteristics for the listed test conditions, unless otherwise noted. Product performance may not be indicated by the Electrical Characteristics if operated under different conditions.

**Table 6. SWITCHING CHARACTERISTICS** (Apply over all recommended conditions,  $T_A = -40^{\circ}\text{C}$  to  $+100^{\circ}\text{C}$ ,  $4.5\text{ V} \leq V_{DD} \leq 30\text{ V}$ , FOD8480:  $I_{F(ON)} = 6\text{ mA}$  to  $10\text{ mA}$ , FOD8482:  $I_{F(ON)} = 4\text{ mA}$  to  $7\text{ mA}$ ,  $V_{F(OFF)} = 0$  to  $0.8\text{ V}$ , unless otherwise specified. Typical value is measured at  $T_A = 25^{\circ}\text{C}$  and  $V_{DD} = 5\text{ V}$ .)

Symbol	Parameter	Conditions	Min	Typ	Max	Units
Date Rate					1	Mbit/s
$t_{PHL}$	Propagation Delay Time to Logic Low Output	With peaking capacitor, $C_L = 15\text{ pF}$		130	300	ns
$t_{PLH}$	Propagation Delay Time to Logic High Output	With peaking capacitor, $C_L = 15\text{ pF}$		100	300	ns
PWD	Pulse Width Distortion, $ t_{PHL} - t_{PLH} $	With peaking capacitor, $C_L = 15\text{ pF}$			250	ns
$t_{PSK}$	Propagation Delay Skew (Note 8)	With peaking capacitor, $C_L = 15\text{ pF}$			150	ns
$t_R$	Output Rise Time (10% – 90%)			15		ns
$t_F$	Output Fall Time (90% – 10%)			10		ns
$ CM_H $	Common Mode Transient Immunity at Output High	$I_F = I_{F(ON)}$ , $V_O > 2.0\text{ V}$ , $V_{CM} = 1000\text{ V}$ , $T_A = 25^{\circ}\text{C}$ (Note 9)	20	40		kV/ $\mu\text{s}$
$ CM_L $	Common Mode Transient Immunity at Output Low	$I_F = 0\text{ mA}$ , $V_O < 0.8\text{ V}$ , $V_{CM} = 1000\text{ V}$ , $T_A = 25^{\circ}\text{C}$ (Note 9)	20	40		kV/ $\mu\text{s}$

8.  $t_{PSK}$  is equal to the magnitude of the worst case difference in  $t_{PHL}$  and/or  $t_{PLH}$  that will be seen between any two units from the same manufacturing date code that are operated at same case temperature ( $\pm 5^{\circ}\text{C}$ ), at same operating conditions, with equal loads ( $C_L = 15\text{ pF}$ ), and with an input rise time less than 5 ns.
9. Common mode transient immunity at output high is the maximum tolerable negative  $dV_{cm}/dt$  on the trailing edge of the common mode impulse signal,  $V_{cm}$ , to assure that the output will remain high. Common mode transient immunity at output low is the maximum tolerable positive  $dV_{cm}/dt$  on the leading edge of the common pulse signal,  $V_{cm}$ , to assure that the output will remain low.

# FOD8480, FOD8482

## TYPICAL CHARACTERISTICS

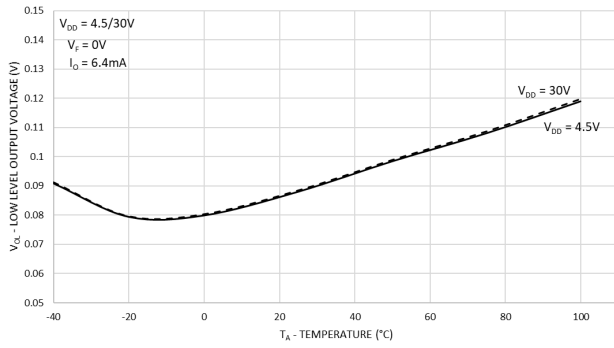

**Figure 1. Typical Logic Low Output Voltage vs. Temperature**



**Figure 2. Typical Logic High Output Current vs. Temperature**

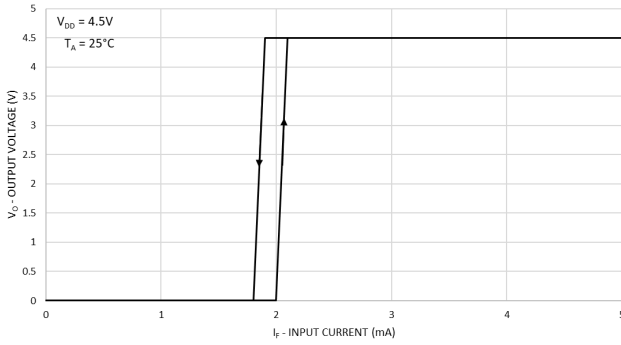

**Figure 3. Typical Output Voltage vs. Forward Input Current (FOD8480)**



**Figure 4. Typical Output Voltage vs. Forward Input Current (FOD8482)**

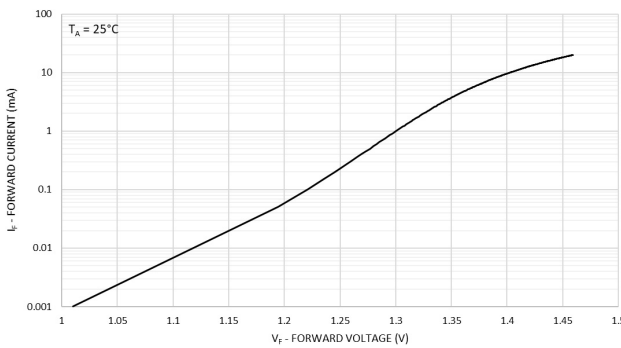

**Figure 5. Typical Input Diode Forward Characteristic**

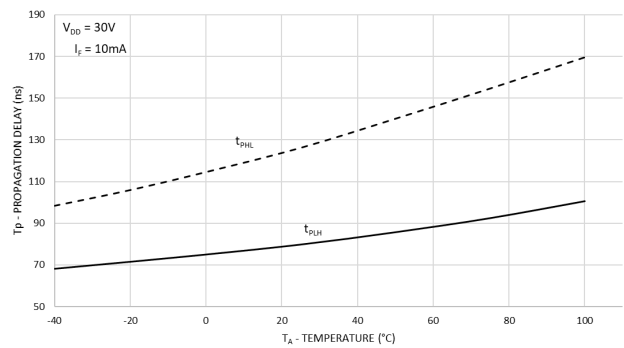

**Figure 6. Typical Propagation Delay vs. Temperature**

# FOD8480, FOD8482

## TYPICAL CHARACTERISTICS

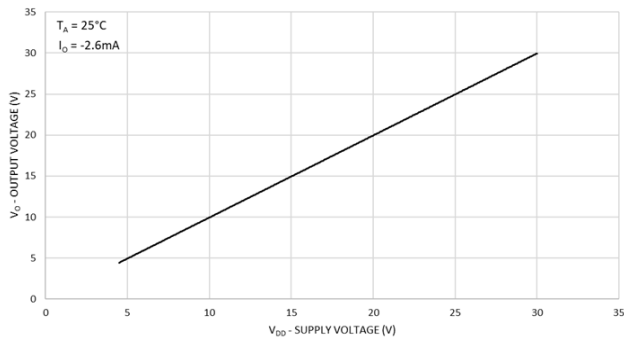

**Figure 7. Typical Logic High Output Voltage vs. Supply Voltage**



**Figure 8. Typical Propagation Delay vs. Supply Voltage**

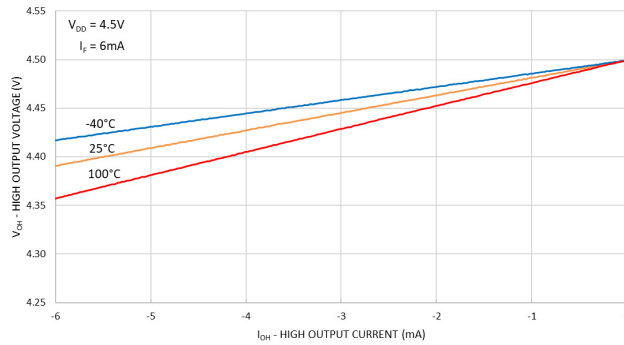

**Figure 9.  $V_{OH}$  vs.  $I_{OH}$  Across Temperatures**

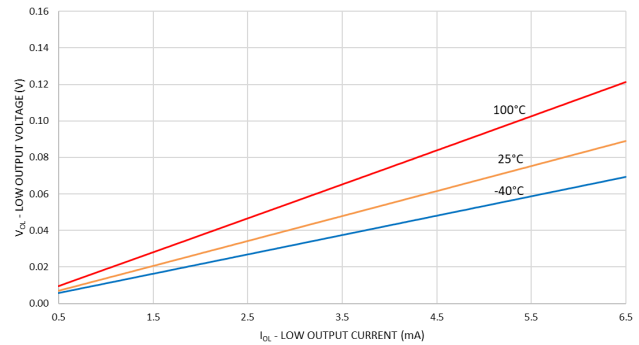

**Figure 10.  $V_{OL}$  vs.  $I_{OL}$  Across Temperatures**

# FOD8480, FOD8482



Figure 11. Test Circuit for Propagation Delay, Rise Time and Fall Time

# FOD8480, FOD8482

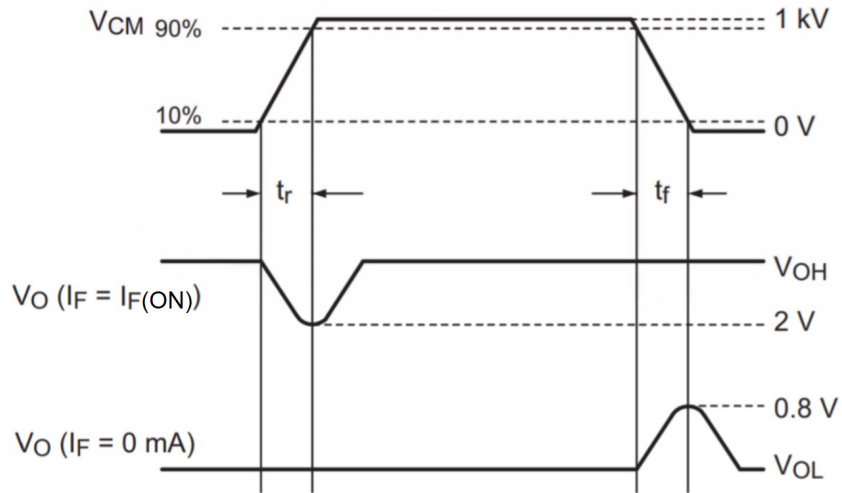
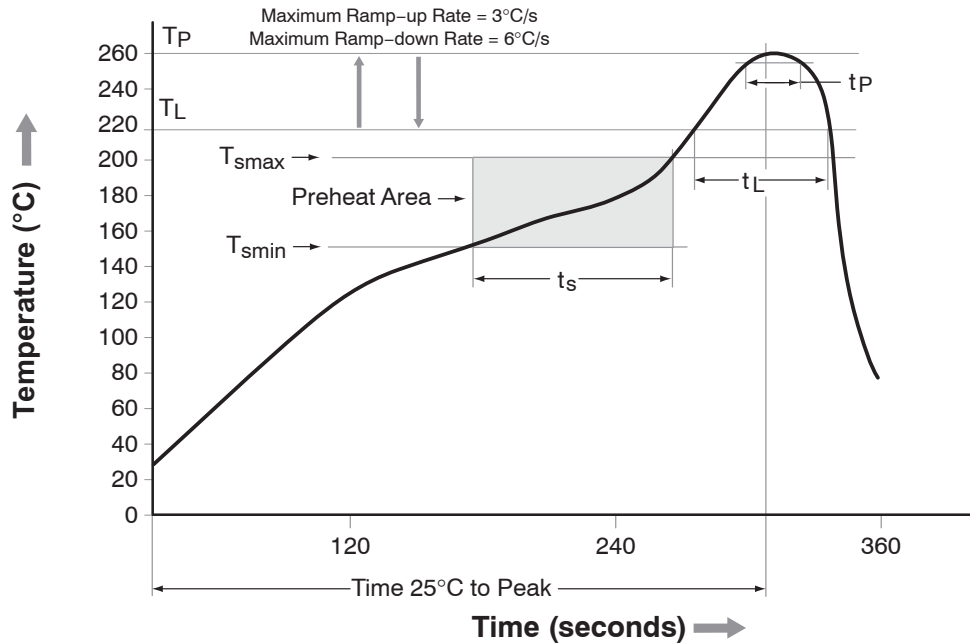

Figure 12. Test Circuit for Instantaneous Common-Mode Rejection Voltage



Reflow Profile



Profile Feature	Pb-Free Assembly Profile
Temperature Minimum ( $T_{smin}$ )	150°C
Temperature Maximum ( $T_{smax}$ )	200°C
Time ( $t_s$ ) from ( $T_{smin}$ to $T_{smax}$ )	60 s to 120 s
Ramp-up Rate ( $t_L$ to $t_P$ )	3°C/second maximum
Liquidous Temperature ( $T_L$ )	217°C
Time ( $t_L$ ) Maintained Above ( $T_L$ )	60 s to 150 s
Peak Body Package Temperature	260°C +0°C / -5°C
Time ( $t_p$ ) within 5°C of 260°C	30 s
Ramp-Down Rate ( $T_P$ to $T_L$ )	6°C/s maximum
Time 25°C to Peak Temperature	8 minutes maximum

Figure 13. Reflow Profile

## FOD8480, FOD8482

### ORDERING INFORMATION

Part Number	Package	Packing Method
FOD8480	Stretched Body SOP 6-Pin	Tube (100 units per tube)
FOD8480R2	Stretched Body SOP 6-Pin	Tape and Reel (1,000 units per reel)
FOD8480V	Stretched Body SOP 6-Pin, DIN EN/IEC60747-5-5 Option	Tube (100 units per tube)
FOD8480R2V	Stretched Body SOP 6-Pin, DIN EN/ IEC60747-5-5 Option	Tape and Reel (1,000 units per reel)
FOD8480T	Stretched Body SOP 6-Pin, Wide Lead	Tube (100 units per tube)
FOD8480TR2	Stretched Body SOP 6-Pin, Wide Lead	Tape and Reel (1,000 units per reel)
FOD8480TV	Stretched Body SOP 6-Pin, Wide Lead, DIN EN/IEC60747-5-5 Option	Tube (100 units per tube)
FOD8480TR2V	Stretched Body SOP 6-Pin, Wide Lead, DIN EN/ IEC60747-5-5 Option	Tape and Reel (1,000 units per reel)

\*All packages are lead free per JEDEC: J-STD-020B standard.

**MECHANICAL CASE OUTLINE**  
**PACKAGE DIMENSIONS**

ON Semiconductor®



**SOIC6**  
**CASE 751EL**  
**ISSUE O**

DATE 30 SEP 2016



**RECOMMENDED LAND PATTERN**



**NOTES: UNLESS OTHERWISE SPECIFIED**

- A) NO STANDARD APPLIES TO THIS PACKAGE
- B) ALL DIMENSIONS ARE IN MILLIMETERS.
- C) DIMENSIONS DO NOT INCLUDE BURRS OR MOLD FLASH, AND TIE BAR EXTRUSION.
- D) DIMENSIONING AND TOLERANCING PER ASME Y14.5M-2009.

<b>DOCUMENT NUMBER:</b>	<b>98AON13745G</b>	Electronic versions are uncontrolled except when accessed directly from the Document Repository. Printed versions are uncontrolled except when stamped "CONTROLLED COPY" in red.
<b>DESCRIPTION:</b>	<b>SOIC6</b>	<b>PAGE 1 OF 1</b>

ON Semiconductor and are trademarks of Semiconductor Components Industries, LLC dba ON Semiconductor or its subsidiaries in the United States and/or other countries. ON Semiconductor reserves the right to make changes without further notice to any products herein. ON Semiconductor makes no warranty, representation or guarantee regarding the suitability of its products for any particular purpose, nor does ON Semiconductor assume any liability arising out of the application or use of any product or circuit, and specifically disclaims any and all liability, including without limitation special, consequential or incidental damages. ON Semiconductor does not convey any license under its patent rights nor the rights of others.

**MECHANICAL CASE OUTLINE**  
**PACKAGE DIMENSIONS**

ON Semiconductor®



**SOIC6 W**  
**CASE 751EM**  
**ISSUE O**

DATE 30 SEP 2016

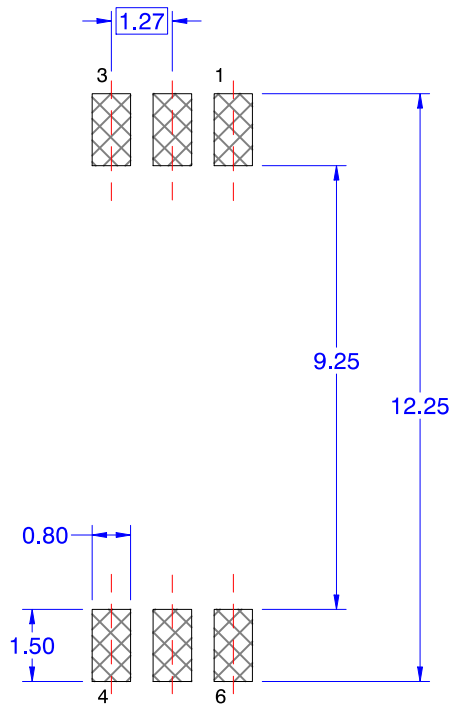

**RECOMMENDED LAND PATTERN**

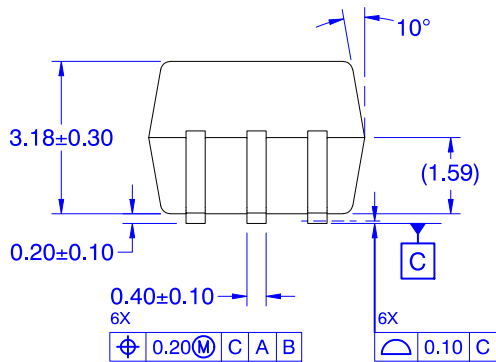

- NOTES: UNLESS OTHERWISE SPECIFIED**
- A) NO STANDARD APPLIES TO THIS PACKAGE
  - B) ALL DIMENSIONS ARE IN MILLIMETERS.
  - C) DIMENSIONS DO NOT INCLUDE BURRS OR MOLD FLASH, AND TIE BAR EXTRUSION.
  - D) DIMENSIONING AND TOLERANCING PER ASME Y14.5M-2009.

<b>DOCUMENT NUMBER:</b>	<b>98AON13749G</b>	Electronic versions are uncontrolled except when accessed directly from the Document Repository. Printed versions are uncontrolled except when stamped "CONTROLLED COPY" in red.
<b>DESCRIPTION:</b>	<b>SOIC6 W</b>	<b>PAGE 1 OF 1</b>

ON Semiconductor and are trademarks of Semiconductor Components Industries, LLC dba ON Semiconductor or its subsidiaries in the United States and/or other countries. ON Semiconductor reserves the right to make changes without further notice to any products herein. ON Semiconductor makes no warranty, representation or guarantee regarding the suitability of its products for any particular purpose, nor does ON Semiconductor assume any liability arising out of the application or use of any product or circuit, and specifically disclaims any and all liability, including without limitation special, consequential or incidental damages. ON Semiconductor does not convey any license under its patent rights nor the rights of others.