

Preliminary datasheet

EconoPIM™2 模块采用第七代沟槽栅/场终止 IGBT7 和第七代发射极控制二极管 带有 PressFIT 压接管脚和温度检测 NTC

特性

- 电气特性
 - $V_{CES} = 1200\text{ V}$
 - $I_{C\text{nom}} = 50\text{ A} / I_{CRM} = 100\text{ A}$
 - 沟槽栅 IGBT7
 - 低 V_{CESat}
 - 过载操作达 175°C
- 机械特性
 - 高功率循环和温度循环能力
 - 集成 NTC 温度传感器
 - 铜基板
 - 低热阻的三氧化二铝 Al_2O_3 衬底
 - PressFIT 压接技术

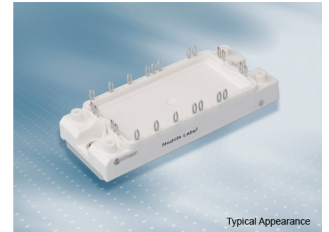

可选应用

- 辅助逆变器
- 电机传动
- 伺服驱动器

产品认证

- 根据 IEC 60747、60749 和 60068 标准的相关测试，符合工业应用的要求。

描述

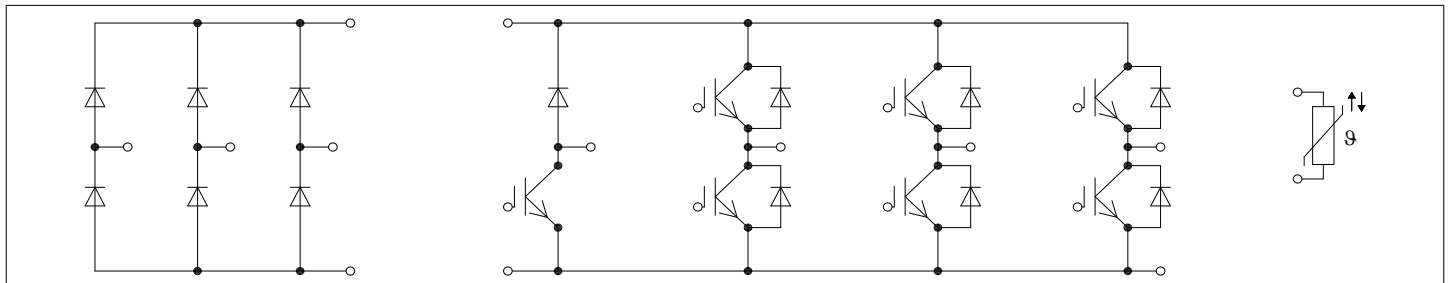

内容

	描述.....	1
	特性.....	1
	可选应用.....	1
	产品认证.....	1
	内容.....	2
1	封装.....	3
2	IGBT, 逆变器	3
3	二极管, 逆变器.....	5
4	二极管, 整流器.....	6
5	IGBT, 斩波器	7
6	Diode-斩波器	8
7	负温度系数热敏电阻.....	9
8	特征参数图表.....	11
9	电路拓扑图.....	17
10	封装尺寸.....	18
11	模块标签代码.....	19
	修订历史.....	20
	免责声明.....	21

1 封装

1 封装

表 1 绝缘参数

特征参数	代号	标注或测试条件	数值	单位
绝缘测试电压	V_{ISOL}	RMS, $f = 50 \text{ Hz}$, $t = 1 \text{ min}$	2.5	kV
模块基板材料			Cu	
内部绝缘		基本绝缘 (class 1, IEC 61140)	Al_2O_3	
爬电距离	d_{Creep}	端子至散热器	10.0	mm
电气间隙	d_{Clear}	端子至散热器	7.5	mm
相对电痕指数	CTI		> 200	
相对温度指数 (电)	RTI	住房	140	°C

表 2 特征值

特征参数	代号	标注或测试条件		数值			单位
				最小值	典型值	最大值	
杂散电感, 模块	L_{SCE}				35		nH
模块引线电阻, 端子-芯片	$R_{AA'+CC'}$	$T_C = 25^\circ\text{C}$, 每个开关			5.5		mΩ
模块引线电阻, 端子-芯片	$R_{CC'+EE'}$	$T_C = 25^\circ\text{C}$, 每个开关			4.8		mΩ
储存温度	T_{stg}			-40		125	°C
模块安装的安装扭矩	M	根据相应的应用手册进行安装	M5, 螺丝	3		6	Nm
重量	G				180		g

2 IGBT, 逆变器

表 3 最大标定值

特征参数	代号	标注或测试条件		数值	单位
集电极-发射极电压	V_{CES}		$T_{vj} = 25^\circ\text{C}$	1200	V
连续集电极直流电流	I_{CDC}	$T_{vj \max} = 175^\circ\text{C}$	$T_C = 100^\circ\text{C}$	50	A
集电极重复峰值电流	I_{CRM}	$t_p = 1 \text{ ms}$		100	A
栅极-发射极峰值电压	V_{GES}			±20	V

表 4 特征值

特征参数	代号	标注或测试条件		数值			单位
				最小值	典型值	最大值	
集电极-发射极饱和电压	$V_{CE\ sat}$	$I_C = 50\ A, V_{GE} = 15\ V$	$T_{vj} = 25\ ^\circ C$		1.50	TBD	V
			$T_{vj} = 125\ ^\circ C$		1.64		
			$T_{vj} = 175\ ^\circ C$		1.72		
栅极阈值电压	V_{GEth}	$I_C = 2\ mA, V_{CE} = V_{GE}, T_{vj} = 25\ ^\circ C$		5.15	5.80	6.45	V
栅极电荷	Q_G	$V_{GE} = \pm 15\ V, V_{CE} = 600\ V$			0.92		μC
内部栅极电阻	R_{Gint}	$T_{vj} = 25\ ^\circ C$			0		Ω
输入电容	C_{ies}	$f = 1000\ kHz, T_{vj} = 25\ ^\circ C, V_{CE} = 25\ V, V_{GE} = 0\ V$			11.1		nF
反向传输电容	C_{res}	$f = 1000\ kHz, T_{vj} = 25\ ^\circ C, V_{CE} = 25\ V, V_{GE} = 0\ V$			0.039		nF
集电极-发射极截止电流	I_{CES}	$V_{CE} = 1200\ V, V_{GE} = 0\ V$	$T_{vj} = 25\ ^\circ C$			0.01	mA
栅极-发射极漏电流	I_{GES}	$V_{CE} = 0\ V, V_{GE} = 20\ V, T_{vj} = 25\ ^\circ C$				100	nA
开通延迟时间(感性负载)	t_{don}	$I_C = 50\ A, V_{CE} = 600\ V, V_{GE} = \pm 15\ V, R_{Gon} = 7.5\ \Omega$	$T_{vj} = 25\ ^\circ C$		0.059		μs
			$T_{vj} = 125\ ^\circ C$		0.061		
			$T_{vj} = 175\ ^\circ C$		0.062		
上升时间(感性负载)	t_r	$I_C = 50\ A, V_{CE} = 600\ V, V_{GE} = \pm 15\ V, R_{Gon} = 7.5\ \Omega$	$T_{vj} = 25\ ^\circ C$		0.043		μs
			$T_{vj} = 125\ ^\circ C$		0.047		
			$T_{vj} = 175\ ^\circ C$		0.049		
关断延迟时间(感性负载)	t_{doff}	$I_C = 50\ A, V_{CE} = 600\ V, V_{GE} = \pm 15\ V, R_{Goff} = 7.5\ \Omega$	$T_{vj} = 25\ ^\circ C$		0.290		μs
			$T_{vj} = 125\ ^\circ C$		0.380		
			$T_{vj} = 175\ ^\circ C$		0.420		
下降时间(感性负载)	t_f	$I_C = 50\ A, V_{CE} = 600\ V, V_{GE} = \pm 15\ V, R_{Goff} = 7.5\ \Omega$	$T_{vj} = 25\ ^\circ C$		0.110		μs
			$T_{vj} = 125\ ^\circ C$		0.200		
			$T_{vj} = 175\ ^\circ C$		0.270		
开通损耗能量(每脉冲)	E_{on}	$I_C = 50\ A, V_{CE} = 600\ V, L_\sigma = 35\ nH, V_{GE} = \pm 15\ V, R_{Gon} = 7.5\ \Omega, di/dt = 900\ A/\mu s (T_{vj} = 175\ ^\circ C)$	$T_{vj} = 25\ ^\circ C$		5.07		mJ
			$T_{vj} = 125\ ^\circ C$		6.76		
			$T_{vj} = 175\ ^\circ C$		7.72		
关断损耗能量(每脉冲)	E_{off}	$I_C = 50\ A, V_{CE} = 600\ V, L_\sigma = 35\ nH, V_{GE} = \pm 15\ V, R_{Goff} = 7.5\ \Omega, dv/dt = 2900\ V/\mu s (T_{vj} = 175\ ^\circ C)$	$T_{vj} = 25\ ^\circ C$		3.37		mJ
			$T_{vj} = 125\ ^\circ C$		5.31		
			$T_{vj} = 175\ ^\circ C$		6.58		

表 4 特征值 (continued)

特征参数	代号	标注或测试条件	数值			单位
			最小值	典型值	最大值	
短路数据	I_{SC}	$V_{GE} \leq 15 \text{ V}, V_{CC} = 800 \text{ V}, V_{CEmax} = V_{CES} - L_{sCE} \cdot di/dt$	$t_p \leq 8 \mu\text{s}, T_{vj} = 150 \text{ }^\circ\text{C}$	190		A
			$t_p \leq 7 \mu\text{s}, T_{vj} = 175 \text{ }^\circ\text{C}$	180		
结—外壳热阻	R_{thJC}	每个 IGBT			0.579	K/W
外壳—散热器热阻	R_{thCH}	每个 IGBT, $\lambda_{grease} = 1 \text{ W}/(\text{m} \cdot \text{K})$		0.147		K/W
允许开关的温度范围	T_{vjop}		-40		175	$^\circ\text{C}$

注: $T_{vjop} > 150^\circ\text{C}$ is allowed for operation at overload conditions. For detailed specifications, please refer to AN 2018-14.

3 二极管,逆变器

表 5 最大标定值

特征参数	代号	标注或测试条件	数值	单位	
反向重复峰值电压	V_{RRM}	$T_{vj} = 25 \text{ }^\circ\text{C}$	1200	V	
连续正向直流电流	I_F		50	A	
正向重复峰值电流	I_{FRM}	$t_p = 1 \text{ ms}$	100	A	
I2t-值	I^2t	$t_p = 10 \text{ ms}, V_R = 0 \text{ V}$	$T_{vj} = 125 \text{ }^\circ\text{C}$	465	A^2s
			$T_{vj} = 175 \text{ }^\circ\text{C}$	420	

表 6 特征值

特征参数	代号	标注或测试条件	数值			单位
			最小值	典型值	最大值	
正向电压	V_F	$I_F = 50 \text{ A}, V_{GE} = 0 \text{ V}$	$T_{vj} = 25 \text{ }^\circ\text{C}$	1.72	TBD	V
			$T_{vj} = 125 \text{ }^\circ\text{C}$	1.59		
			$T_{vj} = 175 \text{ }^\circ\text{C}$	1.52		
反向恢复峰值电流	I_{RM}	$V_R = 600 \text{ V}, I_F = 35 \text{ A}, V_{GE} = -15 \text{ V}, -di_F/dt = 900 \text{ A}/\mu\text{s} (T_{vj} = 175 \text{ }^\circ\text{C})$	$T_{vj} = 25 \text{ }^\circ\text{C}$	31		A
			$T_{vj} = 125 \text{ }^\circ\text{C}$	39		
			$T_{vj} = 175 \text{ }^\circ\text{C}$	45		

4 二极管,整流器

表 6 特征值 (continued)

特征参数	代号	标注或测试条件		数值			单位
				最小值	典型值	最大值	
恢复电荷	Q_r	$V_R = 600\text{ V}, I_F = 50\text{ A}, V_{GE} = -15\text{ V}, -di_F/dt = 900\text{ A}/\mu\text{s} (T_{vj} = 175\text{ }^\circ\text{C})$		$T_{vj} = 25\text{ }^\circ\text{C}$	3.96		μC
				$T_{vj} = 125\text{ }^\circ\text{C}$	7.37		
				$T_{vj} = 175\text{ }^\circ\text{C}$	9.89		
反向恢复损耗 (每脉冲)	E_{rec}	$V_R = 600\text{ V}, I_F = 50\text{ A}, V_{GE} = -15\text{ V}, -di_F/dt = 900\text{ A}/\mu\text{s} (T_{vj} = 175\text{ }^\circ\text{C})$		$T_{vj} = 25\text{ }^\circ\text{C}$	1.31		mJ
				$T_{vj} = 125\text{ }^\circ\text{C}$	2.52		
				$T_{vj} = 175\text{ }^\circ\text{C}$	3.46		
结-外壳热阻	R_{thJC}	每个二极管				0.900	K/W
外壳-散热器热阻	R_{thCH}	每个二极管, $\lambda_{grease} = 1\text{ W}/(\text{m}^*\text{K})$			0.168		K/W
允许开关的温度范围	T_{vjop}			-40		175	$^\circ\text{C}$

注: $T_{vjop} > 150\text{ }^\circ\text{C}$ is allowed for operation at overload conditions. For detailed specifications, please refer to AN 2018-14.

4 二极管,整流器

表 7 最大标定值

特征参数	代号	标注或测试条件		数值	单位
反向重复峰值电压	V_{RRM}	$T_{vj} = 25\text{ }^\circ\text{C}$		1600	V
最大正向均方根电流(每芯片)	I_{FRMSM}	$T_C = 80\text{ }^\circ\text{C}$		70	A
最大整流器输出均方根电流	I_{RMSM}	$T_C = 80\text{ }^\circ\text{C}$		100	A
正向浪涌电流	I_{FSM}	$t_p = 10\text{ ms}$	$T_{vj} = 25\text{ }^\circ\text{C}$	560	A
			$T_{vj} = 150\text{ }^\circ\text{C}$	435	
I2t-值	βt	$t_p = 10\text{ ms}$	$T_{vj} = 25\text{ }^\circ\text{C}$	1570	A^2s
			$T_{vj} = 150\text{ }^\circ\text{C}$	945	

表 8 特征值

特征参数	代号	标注或测试条件		数值			单位
				最小值	典型值	最大值	
正向电压	V_F	$I_F = 50\text{ A}$	$T_{vj} = 150\text{ }^\circ\text{C}$		1.05		V
反向电流	I_r	$T_{vj} = 150\text{ }^\circ\text{C}, V_R = 1600\text{ V}$			1		mA
结-外壳热阻	R_{thJC}	每个二极管				0.870	K/W

表 8 特征值 (continued)

特征参数	代号	标注或测试条件	数值			单位
			最小值	典型值	最大值	
外壳—散热器热阻	R_{thCH}	每个二极管, $\lambda_{grease} = 1 \text{ W}/(\text{m}^2\text{K})$		0.171		K/W
允许开关的温度范围	$T_{vj, op}$		-40		150	°C

5 IGBT, 斩波器

表 9 最大标定值

特征参数	代号	标注或测试条件		数值	单位
集电极—发射极电压	V_{CES}		$T_{vj} = 25 \text{ °C}$	1200	V
连续集电极直流电流	I_{CDC}	$T_{vj max} = 175 \text{ °C}$	$T_C = 100 \text{ °C}$	25	A
集电极重复峰值电流	I_{CRM}	$t_p = 1 \text{ ms}$		50	A
栅极—发射极峰值电压	V_{GES}			±20	V

表 10 特征值

特征参数	代号	标注或测试条件	数值			单位
			最小值	典型值	最大值	
集电极—发射极饱和电压	$V_{CE sat}$	$I_C = 25 \text{ A}, V_{GE} = 15 \text{ V}$	$T_{vj} = 25 \text{ °C}$	1.60	TBD	V
			$T_{vj} = 125 \text{ °C}$	1.74		
			$T_{vj} = 175 \text{ °C}$	1.82		
栅极阈值电压	V_{GEth}	$I_C = 0.525 \text{ mA}, V_{CE} = V_{GE}, T_{vj} = 25 \text{ °C}$	5.15	5.80	6.45	V
栅极电荷	Q_G	$V_{GE} = \pm 15 \text{ V}, V_{CE} = 600 \text{ V}$		0.395		μC
内部栅极电阻	R_{Gint}	$T_{vj} = 25 \text{ °C}$		0		Ω
输入电容	C_{ies}	$f = 1000 \text{ kHz}, T_{vj} = 25 \text{ °C}, V_{CE} = 25 \text{ V}, V_{GE} = 0 \text{ V}$		4.77		nF
反向传输电容	C_{res}	$f = 1000 \text{ kHz}, T_{vj} = 25 \text{ °C}, V_{CE} = 25 \text{ V}, V_{GE} = 0 \text{ V}$		0.017		nF
集电极-发射极截止电流	I_{CES}	$V_{CE} = 1200 \text{ V}, V_{GE} = 0 \text{ V}$	$T_{vj} = 25 \text{ °C}$		0.004	mA
栅极-发射极漏电流	I_{GES}	$V_{CE} = 0 \text{ V}, V_{GE} = 20 \text{ V}, T_{vj} = 25 \text{ °C}$			100	nA
开通延迟时间(感性负载)	t_{don}	$I_C = 25 \text{ A}, V_{CE} = 600 \text{ V}, V_{GE} = \pm 15 \text{ V}, R_{Gon} = 9.1 \text{ } \Omega$	$T_{vj} = 25 \text{ °C}$	0.041		μs
			$T_{vj} = 125 \text{ °C}$	0.043		
			$T_{vj} = 175 \text{ °C}$	0.044		
上升时间(感性负载)	t_r	$I_C = 25 \text{ A}, V_{CE} = 600 \text{ V}, V_{GE} = \pm 15 \text{ V}, R_{Gon} = 9.1 \text{ } \Omega$	$T_{vj} = 25 \text{ °C}$	0.025		μs
			$T_{vj} = 125 \text{ °C}$	0.028		
			$T_{vj} = 175 \text{ °C}$	0.030		

表 10 特征值 (continued)

特征参数	代号	标注或测试条件	数值			单位
			最小值	典型值	最大值	
关断延迟时间(感性负载)	t_{doff}	$I_C = 25\text{ A}, V_{CE} = 600\text{ V}, V_{GE} = \pm 15\text{ V}, R_{Goff} = 9.1\ \Omega$	$T_{vj} = 25\text{ }^\circ\text{C}$	0.230		μs
			$T_{vj} = 125\text{ }^\circ\text{C}$	0.320		
			$T_{vj} = 175\text{ }^\circ\text{C}$	0.350		
下降时间(感性负载)	t_f	$I_C = 25\text{ A}, V_{CE} = 600\text{ V}, V_{GE} = \pm 15\text{ V}, R_{Goff} = 9.1\ \Omega$	$T_{vj} = 25\text{ }^\circ\text{C}$	0.140		μs
			$T_{vj} = 125\text{ }^\circ\text{C}$	0.220		
			$T_{vj} = 175\text{ }^\circ\text{C}$	0.280		
开通损耗能量(每脉冲)	E_{on}	$I_C = 25\text{ A}, V_{CE} = 600\text{ V}, L_\sigma = 35\text{ nH}, V_{GE} = \pm 15\text{ V}, R_{Gon} = 9.1\ \Omega, di/dt = 780\text{ A}/\mu\text{s} (T_{vj} = 175\text{ }^\circ\text{C})$	$T_{vj} = 25\text{ }^\circ\text{C}$	1.47		mJ
			$T_{vj} = 125\text{ }^\circ\text{C}$	2.05		
			$T_{vj} = 175\text{ }^\circ\text{C}$	2.39		
关断损耗能量(每脉冲)	E_{off}	$I_C = 25\text{ A}, V_{CE} = 600\text{ V}, L_\sigma = 35\text{ nH}, V_{GE} = \pm 15\text{ V}, R_{Goff} = 9.1\ \Omega, dv/dt = 3120\text{ V}/\mu\text{s} (T_{vj} = 175\text{ }^\circ\text{C})$	$T_{vj} = 25\text{ }^\circ\text{C}$	1.65		mJ
			$T_{vj} = 125\text{ }^\circ\text{C}$	2.58		
			$T_{vj} = 175\text{ }^\circ\text{C}$	3.13		
短路数据	I_{SC}	$V_{GE} \leq 15\text{ V}, V_{CC} = 800\text{ V}, V_{CEmax} = V_{CES} - L_{sCE} * di/dt$	$t_p \leq 8\ \mu\text{s}, T_{vj} = 150\text{ }^\circ\text{C}$	90		A
			$t_p \leq 7\ \mu\text{s}, T_{vj} = 175\text{ }^\circ\text{C}$	85		
结-外壳热阻	R_{thJC}	每个 IGBT			0.967	K/W
外壳-散热器热阻	R_{thCH}	每个 IGBT, $\lambda_{grease} = 1\text{ W}/(\text{m}^*\text{K})$		0.171		K/W
允许开关的温度范围	$T_{vj\ op}$		-40		175	$^\circ\text{C}$

注: $T_{vj\ op} > 150\text{ }^\circ\text{C}$ is allowed for operation at overload conditions. For detailed specifications, please refer to AN 2018-14.

6 Diode-斩波器

表 11 最大标定值

特征参数	代号	标注或测试条件	数值	单位	
反向重复峰值电压	V_{RRM}	$T_{vj} = 25\text{ }^\circ\text{C}$	1200	V	
连续正向直流电流	I_F		25	A	
正向重复峰值电流	I_{FRM}	$t_p = 1\text{ ms}$	50	A	
I2t-值	I^2t	$t_p = 10\text{ ms}, V_R = 0\text{ V}$	$T_{vj} = 125\text{ }^\circ\text{C}$	125	A^2s
			$T_{vj} = 175\text{ }^\circ\text{C}$	95	

7 负温度系数热敏电阻

表 12 特征值

特征参数	代号	标注或测试条件	数值			单位	
			最小值	典型值	最大值		
正向电压	V_F	$I_F = 25 \text{ A}, V_{GE} = 0 \text{ V}$	$T_{vj} = 25 \text{ }^\circ\text{C}$		1.83	TBD	V
			$T_{vj} = 125 \text{ }^\circ\text{C}$		1.70		
			$T_{vj} = 175 \text{ }^\circ\text{C}$		1.63		
反向恢复峰值电流	I_{RM}	$V_R = 600 \text{ V}, I_F = 25 \text{ A}, V_{GE} = -15 \text{ V}, -di_F/dt = 395 \text{ A}/\mu\text{s} (T_{vj} = 175 \text{ }^\circ\text{C})$	$T_{vj} = 25 \text{ }^\circ\text{C}$		18		A
			$T_{vj} = 125 \text{ }^\circ\text{C}$		25		
			$T_{vj} = 175 \text{ }^\circ\text{C}$		29		
恢复电荷	Q_r	$V_R = 600 \text{ V}, I_F = 25 \text{ A}, V_{GE} = -15 \text{ V}, -di_F/dt = 395 \text{ A}/\mu\text{s} (T_{vj} = 175 \text{ }^\circ\text{C})$	$T_{vj} = 25 \text{ }^\circ\text{C}$		2.79		μC
			$T_{vj} = 125 \text{ }^\circ\text{C}$		3.36		
			$T_{vj} = 175 \text{ }^\circ\text{C}$		4.41		
反向恢复损耗（每脉冲）	E_{rec}	$V_R = 600 \text{ V}, I_F = 25 \text{ A}, V_{GE} = -15 \text{ V}, -di_F/dt = 395 \text{ A}/\mu\text{s} (T_{vj} = 175 \text{ }^\circ\text{C})$	$T_{vj} = 25 \text{ }^\circ\text{C}$		1.36		mJ
			$T_{vj} = 125 \text{ }^\circ\text{C}$		1.54		
			$T_{vj} = 175 \text{ }^\circ\text{C}$		2.03		
结-外壳热阻	R_{thJC}	每个二极管			1.43	K/W	
外壳-散热器热阻	R_{thCH}	每个二极管, $\lambda_{grease} = 1 \text{ W}/(\text{m} \cdot \text{K})$		0.182		K/W	
允许开关的温度范围	$T_{vj op}$		-40		175	$^\circ\text{C}$	

注: $T_{vj op} > 150^\circ\text{C}$ is allowed for operation at overload conditions. For detailed specifications, please refer to AN 2018-14.

7 负温度系数热敏电阻

表 13 特征值

特征参数	代号	标注或测试条件	数值			单位
			最小值	典型值	最大值	
额定电阻值	R_{25}	$T_{NTC} = 25 \text{ }^\circ\text{C}$		5		k Ω
R_{100} 偏差	$\Delta R/R$	$T_{NTC} = 100 \text{ }^\circ\text{C}, R_{100} = 493 \text{ } \Omega$	-5		5	%
耗散功率	P_{25}	$T_{NTC} = 25 \text{ }^\circ\text{C}$			20	mW
B-值	$B_{25/50}$	$R_2 = R_{25} \exp[B_{25/50}(1/T_2 - 1/(298,15 \text{ K}))]$		3375		K
B-值	$B_{25/80}$	$R_2 = R_{25} \exp[B_{25/80}(1/T_2 - 1/(298,15 \text{ K}))]$		3411		K
B-值	$B_{25/100}$	$R_2 = R_{25} \exp[B_{25/100}(1/T_2 - 1/(298,15 \text{ K}))]$		3433		K

注: 根据应用手册标定

8 特征参数图表

输出特性 (典型), IGBT, 逆变器

$I_C = f(V_{CE})$
 $V_{GE} = 15\text{ V}$

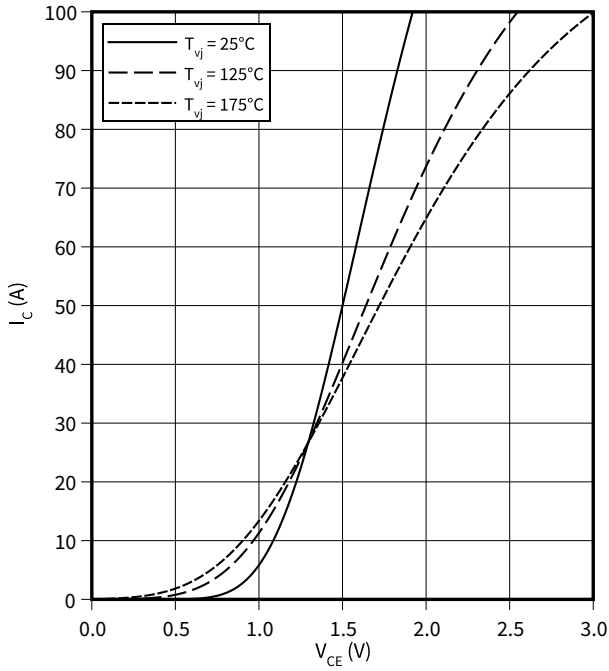

输出特性 (典型), IGBT, 逆变器

$I_C = f(V_{CE})$
 $T_{vj} = 175\text{ °C}$

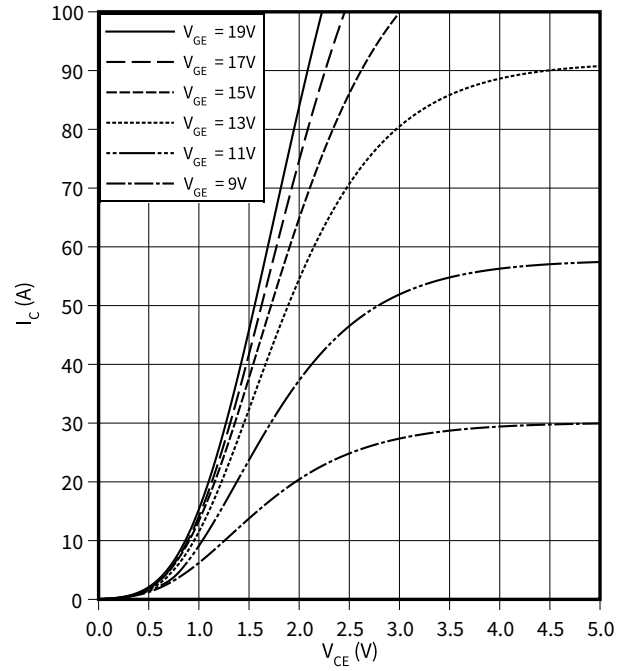

传输特性 (典型), IGBT, 逆变器

$I_C = f(V_{GE})$
 $V_{CE} = 20\text{ V}$

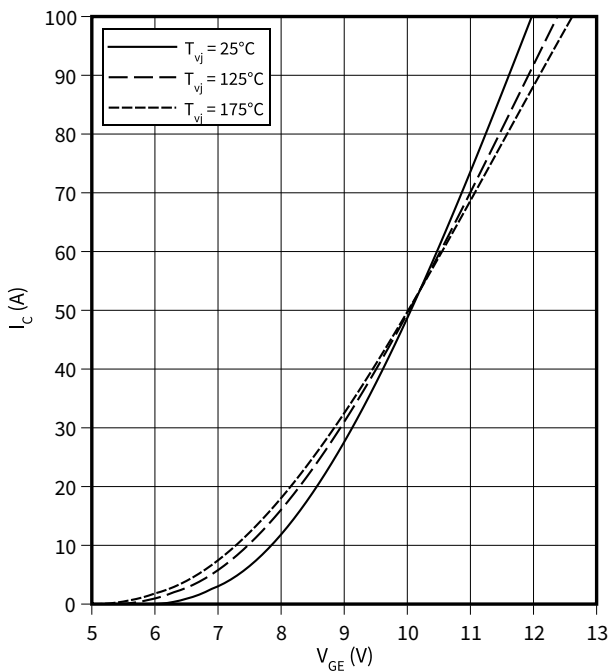

开关损耗 (典型), IGBT, 逆变器

$E = f(I_C)$
 $R_{Goff} = 7.5\ \Omega, R_{Gon} = 7.5\ \Omega, V_{CE} = 600\text{ V}, V_{GE} = \pm 15\text{ V}$

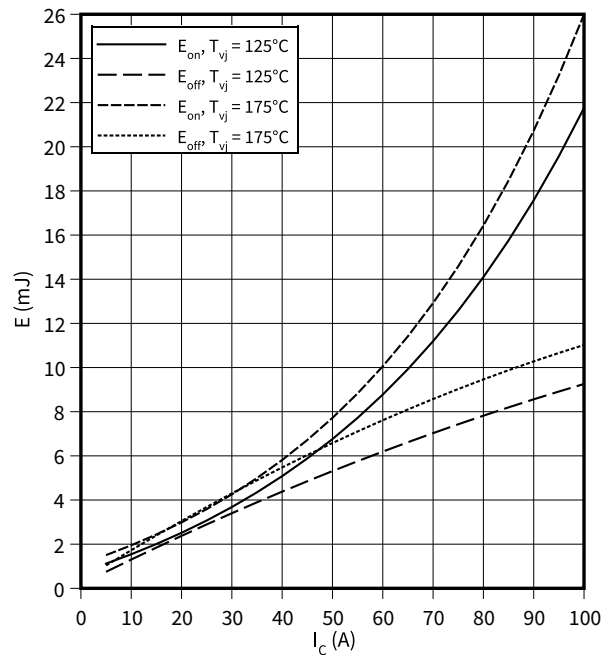

8 特征参数图表

开关损耗 (典型), IGBT, 逆变器

$E = f(R_G)$

$I_C = 50 \text{ A}, V_{CE} = 600 \text{ V}, V_{GE} = \pm 15 \text{ V}$

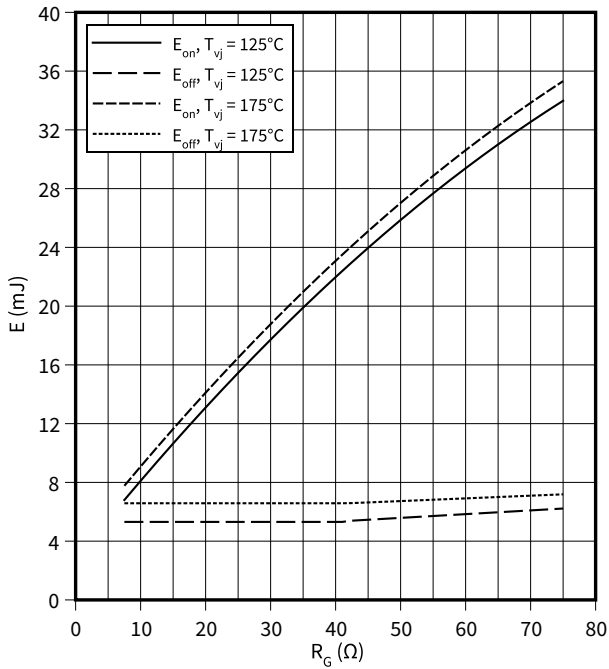

??? (典型), IGBT, 逆变器

$t = f(I_C)$

$R_{Goff} = 7.5 \Omega, R_{Gon} = 7.5 \Omega, V_{CE} = 600 \text{ V}, V_{GE} = \pm 15 \text{ V}, T_{vj} = 175 \text{ °C}$

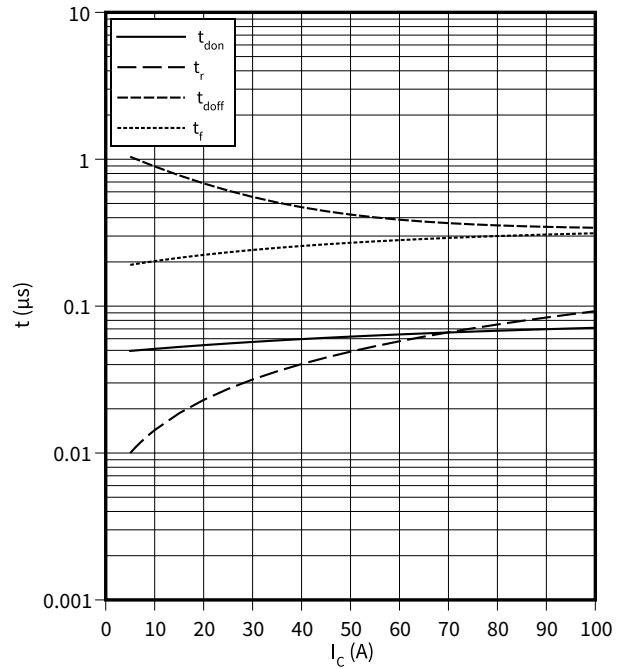

??? (典型), IGBT, 逆变器

$t = f(R_G)$

$I_C = 50 \text{ A}, V_{CE} = 600 \text{ V}, V_{GE} = \pm 15 \text{ V}, T_{vj} = 175 \text{ °C}$

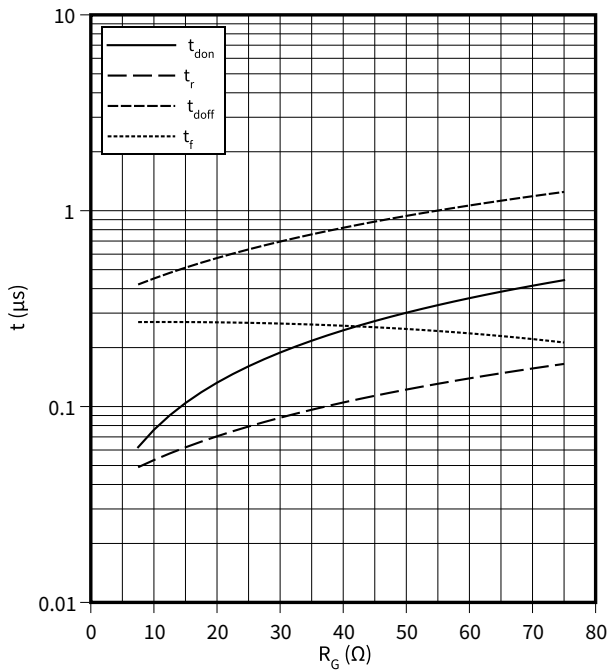

瞬态热阻抗, IGBT, 逆变器

$Z_{th} = f(t)$

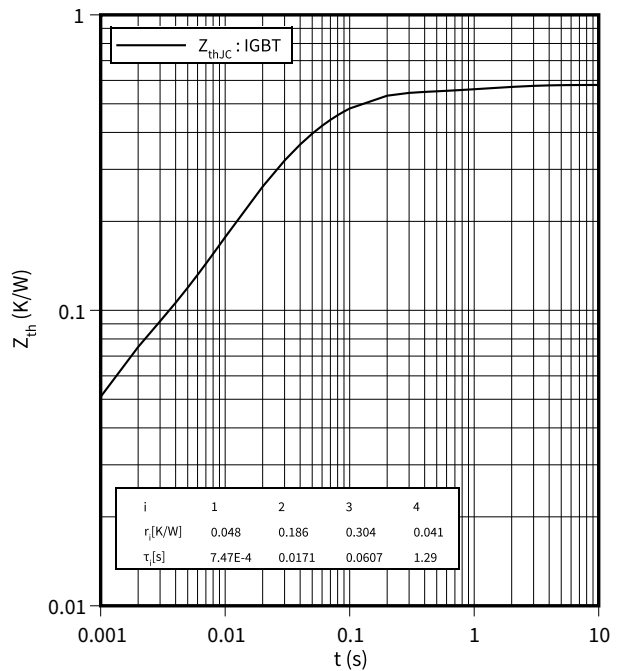

反偏安全工作区 (RBSOA), IGBT, 逆变器

$I_C = f(V_{CE})$

$R_{Goff} = 7.5 \Omega, V_{GE} = \pm 15 V, T_{vj} = 175 \text{ }^\circ\text{C}$

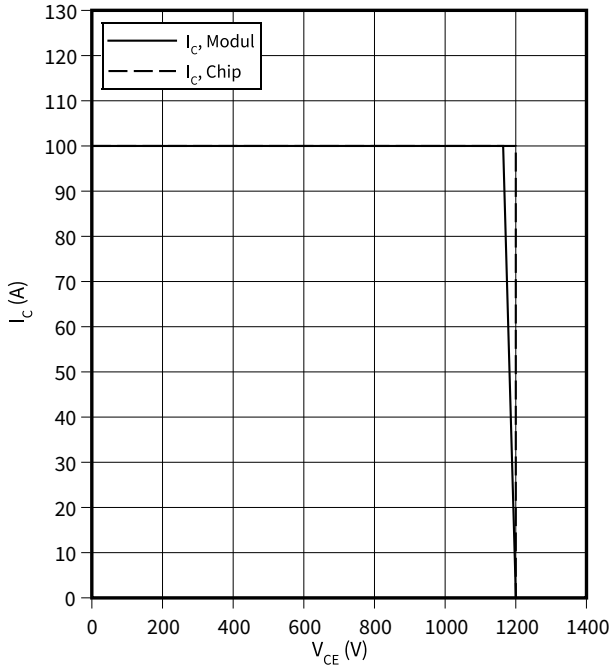

dv/dt (典型), IGBT, 逆变器

$dv/dt = f(R_G)$

$I_C = 50 A, V_{CE} = 600 V, V_{GE} = \pm 15 V, T_{vj} = 25 \text{ }^\circ\text{C}$

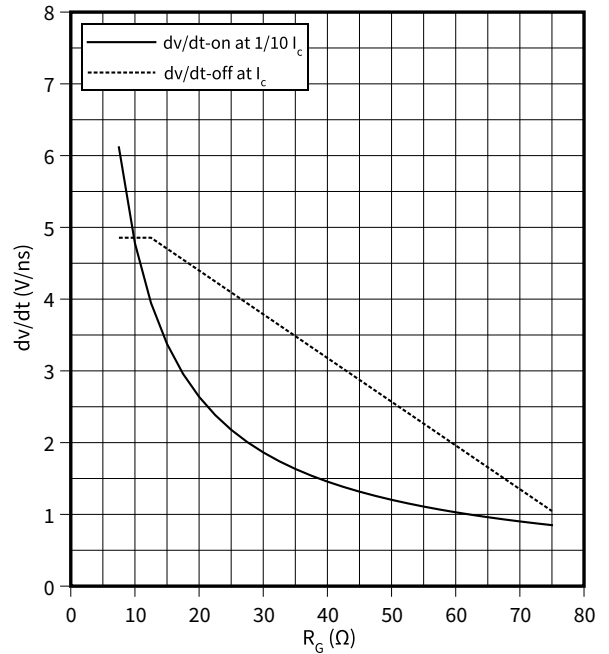

电容特性 (典型), IGBT, 逆变器

$C = f(V_{CE})$

$f = 100 \text{ kHz}, V_{GE} = 0 V, T_{vj} = 25 \text{ }^\circ\text{C}$

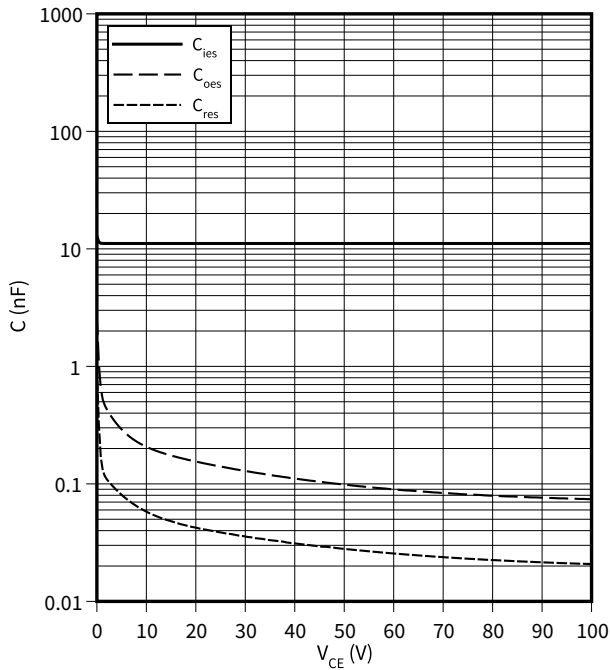

栅极电荷特性 (典型), IGBT, 逆变器

$V_{GE} = f(Q_G)$

$I_C = 50 A, T_{vj} = 25 \text{ }^\circ\text{C}$

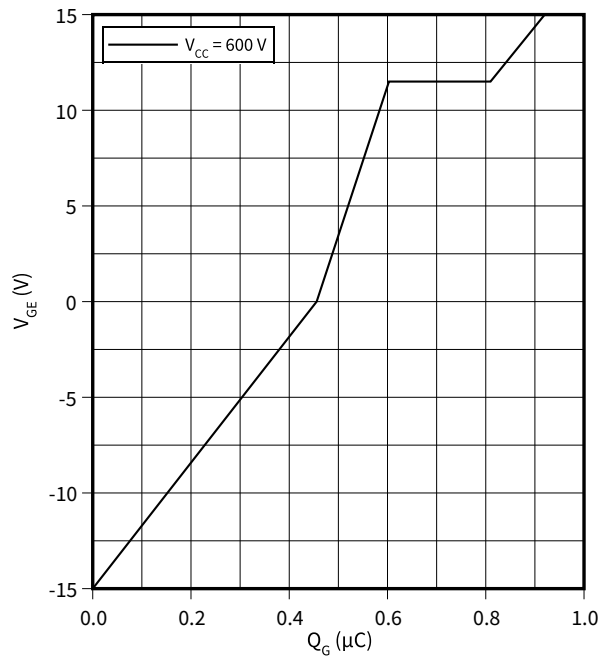

8 特征参数图表

正向偏压特性 (典型), 二极管, 逆变器

$I_F = f(V_F)$

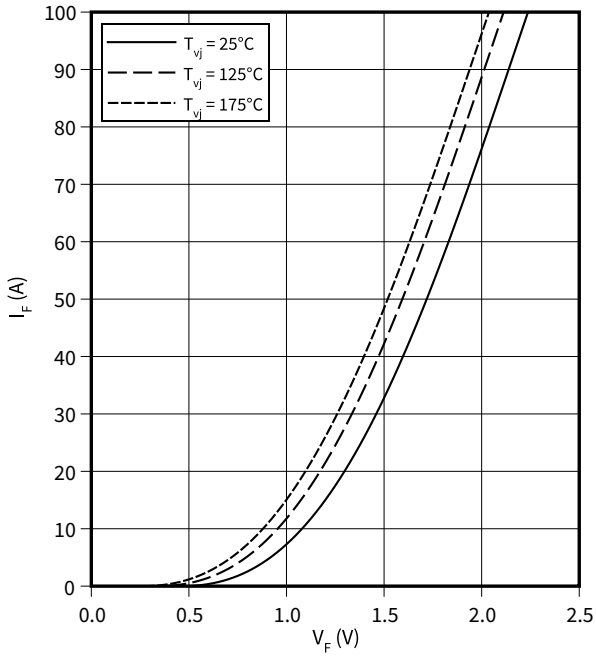

开关损耗 (典型), 二极管, 逆变器

$E_{rec} = f(I_F)$

$R_{Gon} = 7.5 \Omega, V_{CE} = 600 V$

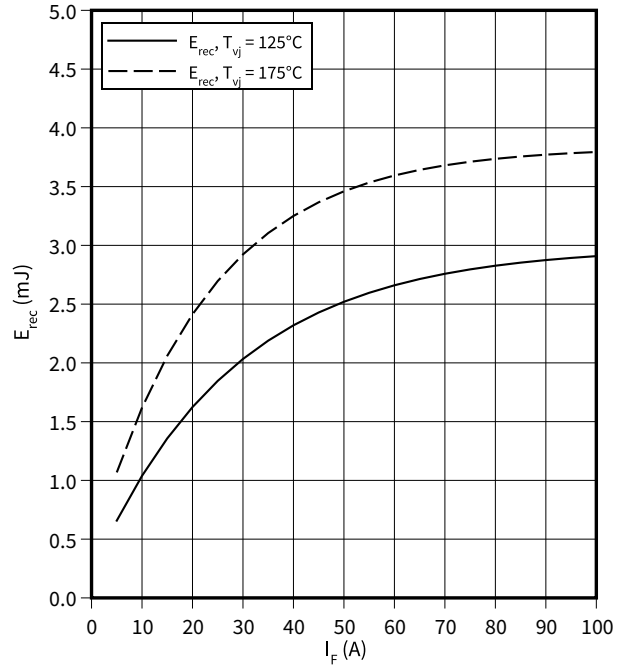

开关损耗 (典型), 二极管, 逆变器

$E_{rec} = f(R_G)$

$V_{CE} = 600 V, I_F = 50 A$

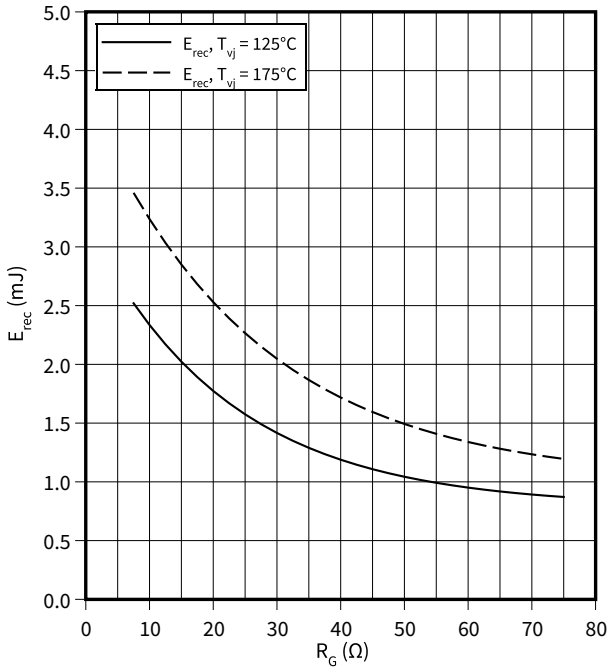

瞬态热阻抗, 二极管, 逆变器

$Z_{th} = f(t)$

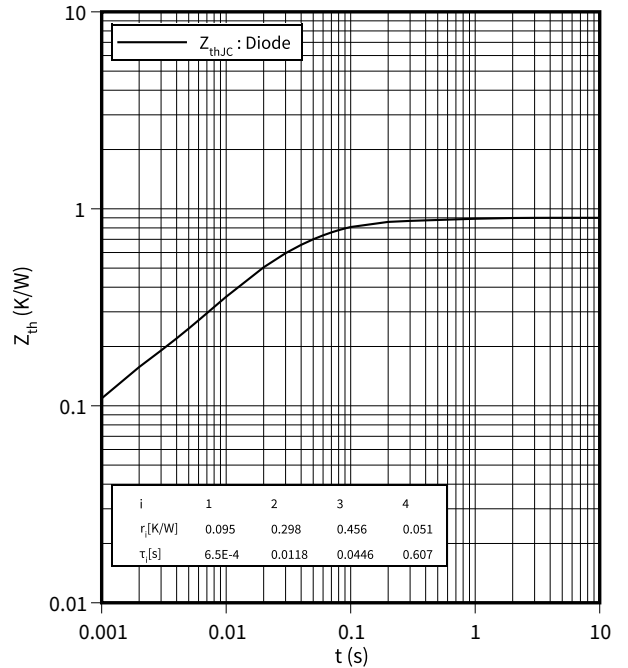

正向偏压特性 (典型), 二极管, 整流器

$$I_F = f(V_F)$$

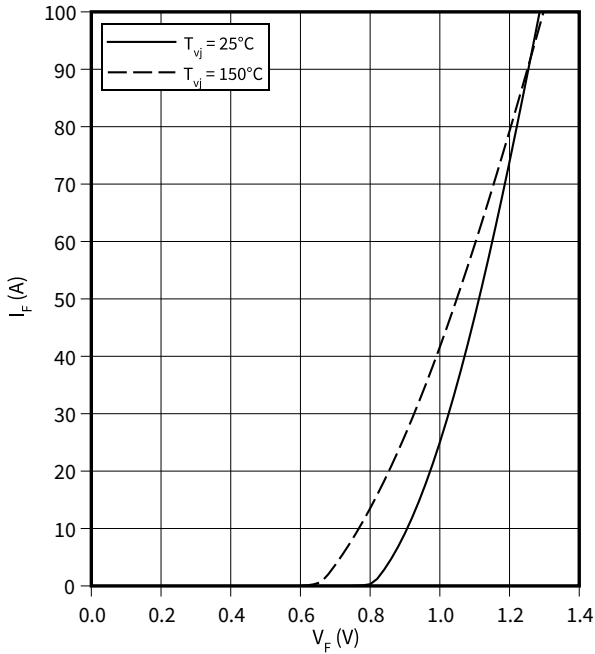

瞬态热阻抗, 二极管, 整流器

$$Z_{th} = f(t)$$

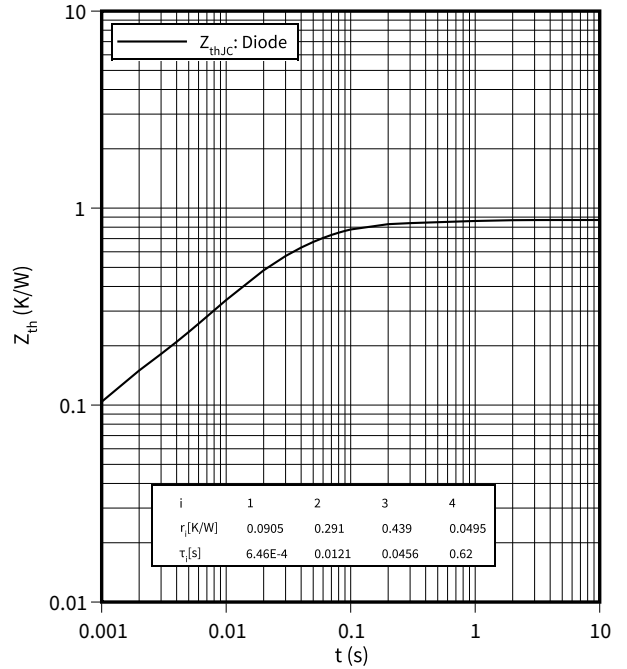

输出特性 (典型), IGBT, 斩波器

$$I_C = f(V_{CE})$$

$$V_{GE} = 15 \text{ V}$$

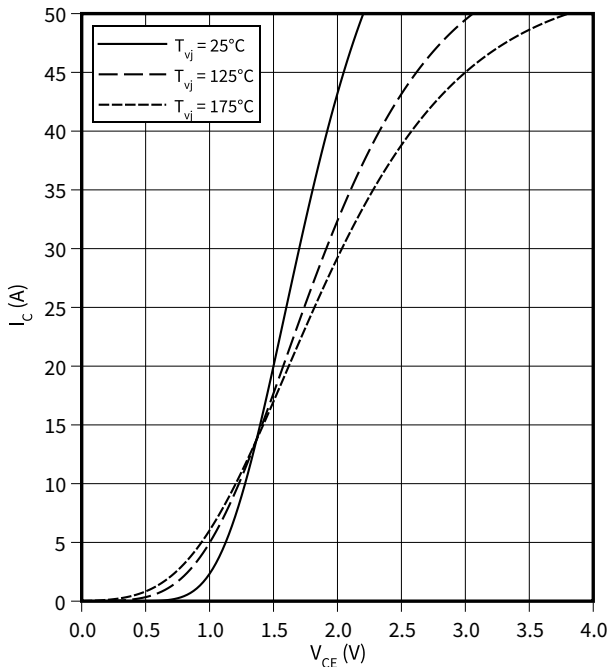

正向偏压特性 (典型), Diode-斩波器

$$I_F = f(V_F)$$

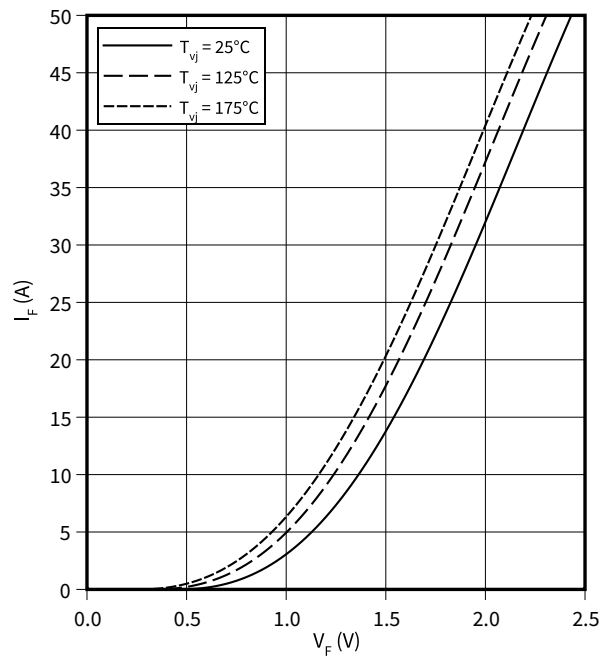

温度特性, 负温度系数热敏电阻

$$R = f(T_{NTC})$$

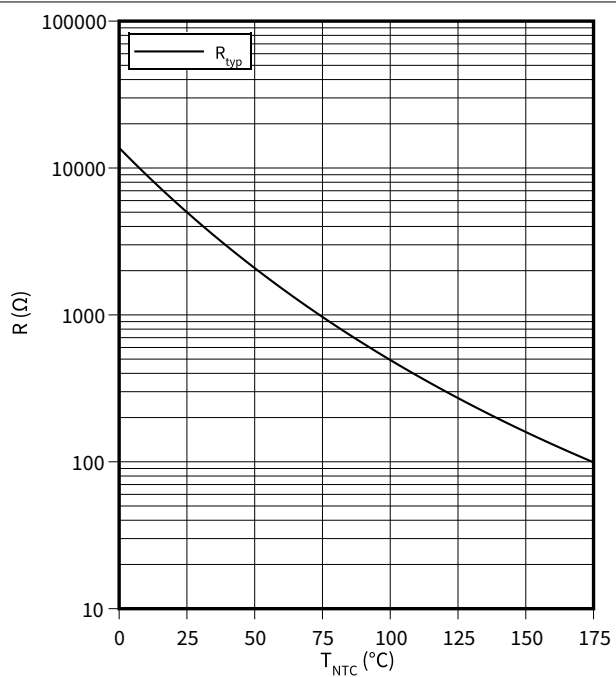

9 电路拓扑图



图 2

10 封装尺寸

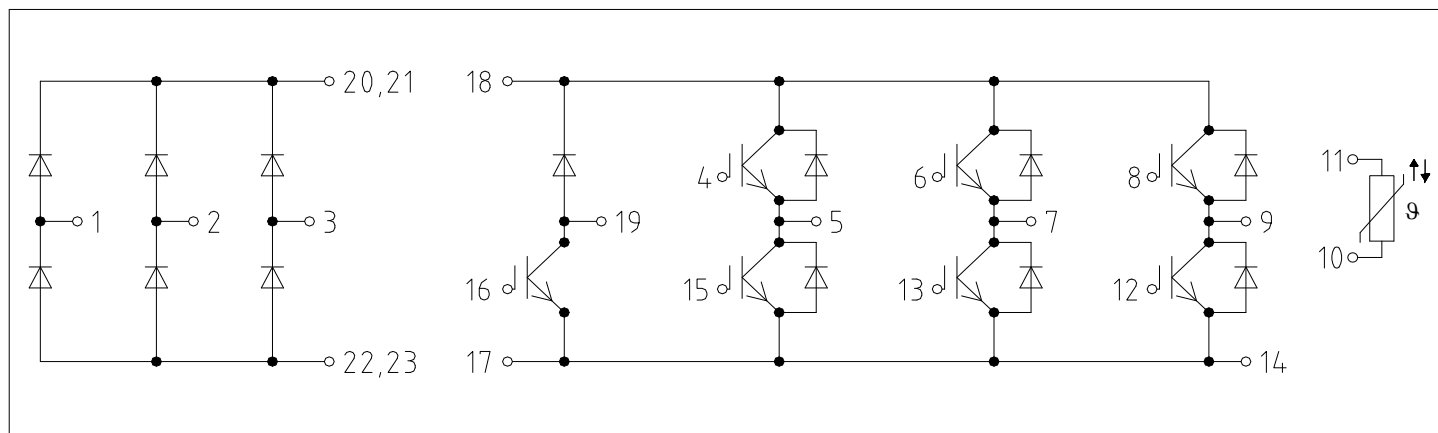

图 3

11 模块标签代码

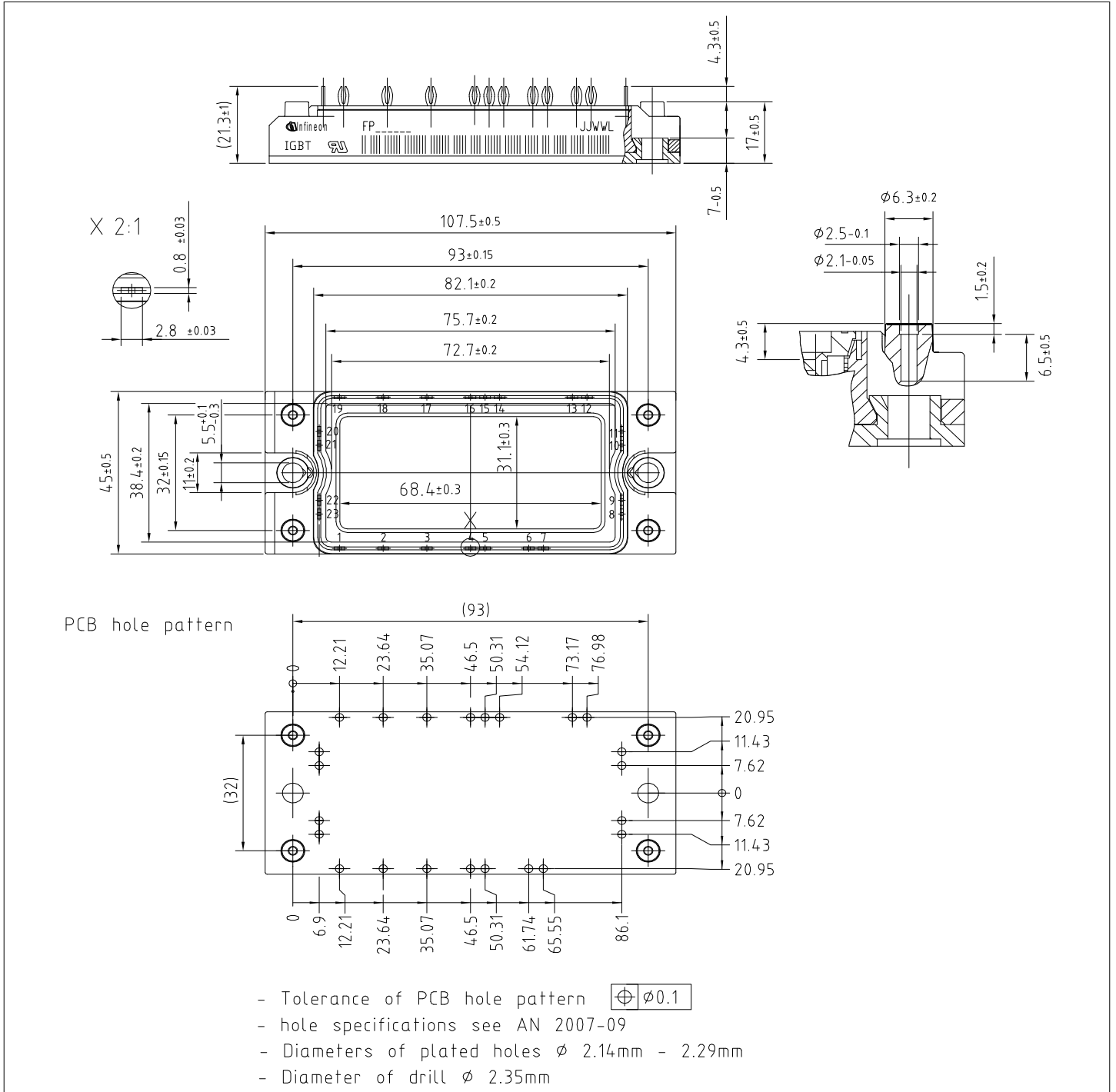

Module label code			
Code format	Data Matrix	Barcode Code128	
Encoding	ASCII text	Code Set A	
Symbol size	16x16	23 digits	
Standard	IEC24720 and IEC16022	IEC8859-1	
Code content	<i>Content</i>	<i>Digit</i>	<i>Example</i>
	Module serial number	1 - 5	71549
	Module material number	6 - 11	142846
	Production order number	12 - 19	55054991
	Date code (production year)	20 - 21	15
	Date code (production week)	22 - 23	30
Example	 		
	71549142846550549911530		71549142846550549911530

图 4

修订历史

修订历史

修订版本	发布日期	变更说明
0.10	2021-06-17	Initial version