

# KTFRDM34933EVBUG

FRDM-34933EVB evaluation board

Rev. 1.0 — 15 March 2017

User guide

## 1 FRDM-34933EVB

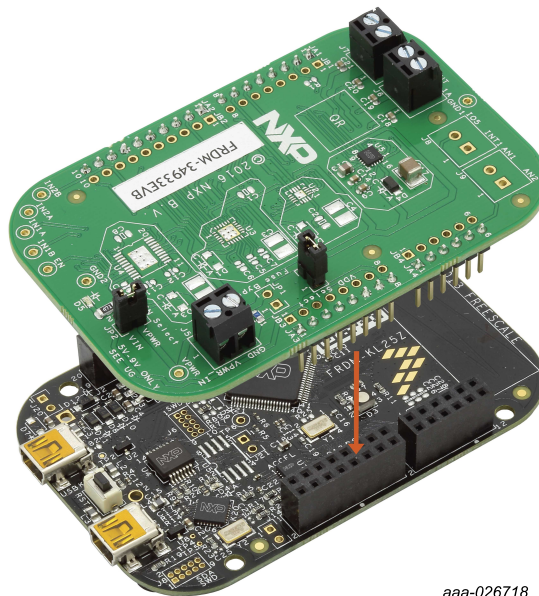

aaa-026718

Figure 1. FRDM-34933EVB with FRDM-KL25Z Freedom Development Platform



## 2 Important notice

---

NXP provides the enclosed product(s) under the following conditions:

This evaluation kit is intended for use of ENGINEERING DEVELOPMENT OR EVALUATION PURPOSES ONLY. It is provided as a sample IC pre-soldered to a printed circuit board to make it easier to access inputs, outputs, and supply terminals. This evaluation board may be used with any development system or other source of I/O signals by simply connecting it to the host MCU or computer board via off-the-shelf cables. This evaluation board is not a Reference Design and is not intended to represent a final design recommendation for any particular application. Final device in an application will be heavily dependent on proper printed circuit board layout and heat sinking design as well as attention to supply filtering, transient suppression, and I/O signal quality.

The goods provided may not be complete in terms of required design, marketing, and or manufacturing related protective considerations, including product safety measures typically found in the end product incorporating the goods. Due to the open construction of the product, it is the user's responsibility to take any and all appropriate precautions with regard to electrostatic discharge. In order to minimize risks associated with the customers applications, adequate design and operating safeguards must be provided by the customer to minimize inherent or procedural hazards. For any safety concerns, contact NXP sales and technical support services.

Should this evaluation kit not meet the specifications indicated in the kit, it may be returned within 30 days from the date of delivery and will be replaced by a new kit.

NXP reserves the right to make changes without further notice to any products herein. NXP makes no warranty, representation or guarantee regarding the suitability of its products for any particular purpose, nor does NXP assume any liability arising out of the application or use of any product or circuit, and specifically disclaims any and all liability, including without limitation consequential or incidental damages. "Typical" parameters can and do vary in different applications and actual performance may vary over time. All operating parameters, including "Typical", must be validated for each customer application by customer's technical experts.

NXP does not convey any license under its patent rights nor the rights of others. NXP products are not designed, intended, or authorized for use as components in systems intended for surgical implant into the body, or other applications intended to support or sustain life, or for any other application in which the failure of the NXP product could create a situation where personal injury or death may occur.

Should the Buyer purchase or use NXP products for any such unintended or unauthorized application, the Buyer shall indemnify and hold NXP and its officers, employees, subsidiaries, affiliates, and distributors harmless against all claims, costs, damages, and expenses, and reasonable attorney fees arising out of, directly or indirectly, any claim of personal injury or death associated with such unintended or unauthorized use, even if such claim alleges NXP was negligent regarding the design or manufacture of the part.

NXP and the NXP logo are trademarks of NXP B.V. All other product or service names are the property of their respective owners. © NXP B.V. 2017.

## 3 Getting started

### 3.1 Kit contents/packing list

The kit contents include:

- Assembled and tested evaluation board/module in an anti-static bag
- Quick Start Guide, Analog Tools
- Warranty card

### 3.2 Jump start

NXP's analog product development boards provide an easy-to-use platform for evaluating NXP products. The boards support a range of analog, mixed-signal and power solutions. They incorporate monolithic ICs and system-in-package devices that use proven high-volume technology. NXP products offer longer battery life, a smaller form factor, reduced component counts, lower cost and improved performance in powering state of the art systems.

1. Go to the tool summary page: <http://www.nxp.com/FRDM-34933EVB>
2. Locate and click:



3. Download the documents, software and other information.

Once the files are downloaded, review the user guide in the bundle. The user guide includes setup instructions, BOM and schematics. Jump start bundles are available on each tool summary page with the most relevant and current information. The information includes everything needed for design.

### 3.3 Required equipment

To use this kit, you need:

- DC power supply (2.0 V to 7.0 V, 0.1 A to 1.0 A, depending on stepper motor requirements)
- USB A to mini-B cable
- Oscilloscope (preferably 4-channel) with current probe(s)
- Digital multimeter
- FRDM-KL25Z Freedom Development Platform
- Typical loads (stepper motor, brushed DC motors, or power resistors)
- 3/16" blade screwdriver
- One 12-pin (PPTC062LFBN-RC), two 16-pin (PPTC082LFBN-RC), and one 20-pin (PPTC102LFBN-RC) female connector, by Sullins Connector Solutions, or equivalent soldered to FRDM-KL25Z

### 3.4 System requirements

The kit requires the following:

- USB-enabled PC with Windows® XP or higher

## 4 Getting to know the hardware

### 4.1 Board overview

The evaluation board features the dual H-bridge ICs, which features the ability to drive either a single two phase stepper motor or two brushed DC motors. The dual H-bridge ICs incorporate internal control logic, a charge pump, gate drive, high current, and low  $R_{DS(on)}$  MOSFET output circuitry.

### 4.2 Board features

The evaluation board is designed to easily evaluate and test the main component, the H-bridge devices. The board's main features are as follows:

- Compatible with Freedom series evaluation boards such as FRDM-KL25Z
- Built in fuse for both part and load protection
- Screw terminals to provide easy connection of power and loads
- Test points to allow probing of signals
- Built-in voltage regulator to supply logic level circuitry
- LED to indicate status of logic power supply of the evaluation board, as well as a general purpose indicator

### 4.3 Device features

The evaluation board feature the following NXP product:

**Table 1. Device features**

| Evaluation board | Device               | Device features   |
|------------------|----------------------|---|
| FRDM-34933EVB    | MC34933 (16-pin QFN) | <p>The NXP MC34933 is a four channel dual H-bridge IC that is ideal for portable electronic applications to control single stepper motor or two Brush DC motors.</p> <ul style="list-style-type: none"> <li>• 2.0 V to 7.0 V dual H-bridge motor driver with enable and tristate bridge control via a parallel MCU interface. Output current 1.0 A continuous, 1.4 A peak.</li> <li>• The IC has low RDS on-resistance of 1.0 Ohm (max.) and the drivers can be PWM-ed up to 200 kHz control frequency.</li> <li>• Contains an integrated charge pump and level shifter (for gate drive voltages), in addition to integrated shoot through current protection and under voltage circuit detector to avoid malfunction</li> <li>• Four output control modes: forward, reverse, brake, tristate (open)</li> </ul> |

**4.4 Board description**

The following sections describe the additional hardware used to support the dual H-bridge driver.

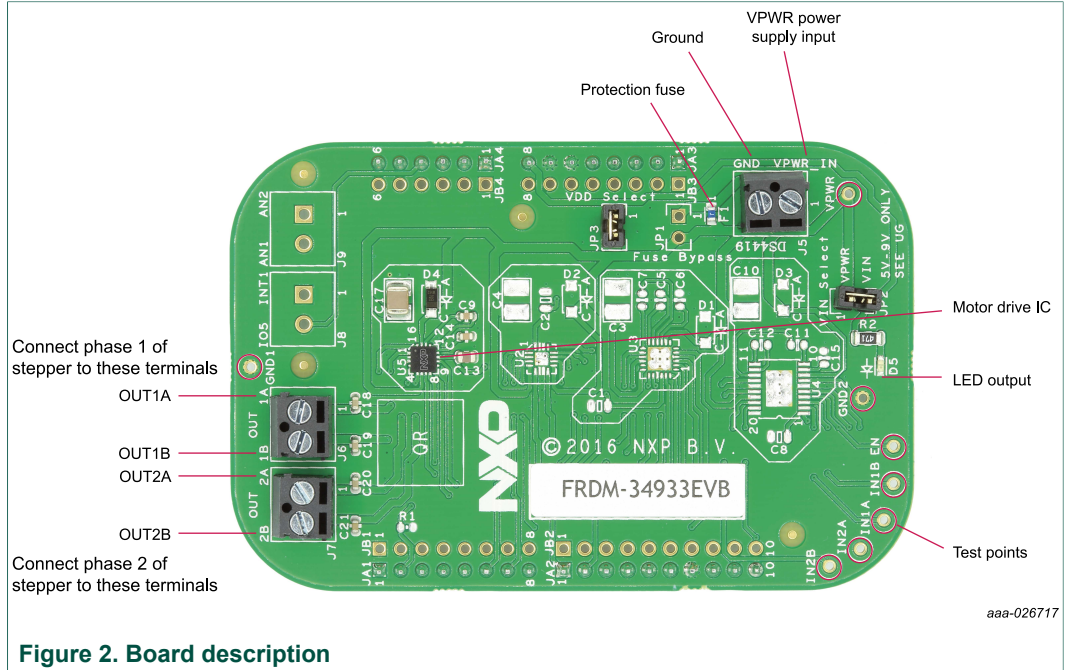

**Figure 2. Board description**

**Table 2. Board description**

| Name  | Description                                  |
|-------|--|
| U5    | 16-pin QFN H-bridge motor drive IC (MC34933) |
| F1    | Overcurrent fuse                             |
| D5    | LED output                                   |
| OUT1A | Connect motor phase 1A to this terminal      |
| OUT1B | Connect motor phase 1B to this terminal      |
| OUT2A | Connect motor phase 2A to this terminal      |
| OUT2B | Connect motor phase 2B to this terminal      |
| VPWR  | Power supply Input terminal                  |
| GND   | Ground terminal                              |
| JA1   | Interface connection to FRDM-KL25Z           |
| JA2   | Interface connection to FRDM-KL25Z           |
| JA3   | Interface connection to FRDM-KL25Z           |
| JA4   | Interface connection to FRDM-KL25Z           |

**4.4.1 LED display**

An LED is provided as a visual output device for the board.

Table 3. LED display

| LED ID | Description   |
|--------|---|
| D5     | Indicates when power is supplied to the board via JP2 |

#### 4.4.2 Test point definitions

The following test points provide access to signals on the board.

Table 4. Test point definitions

| TP# | Signal name | Description                     |
|-----|-------------|---------------------------------|
| TP1 | VPWR        | Power input after fuse          |
| TP2 | EN          | Enable signal                   |
| TP3 | GND1        | Ground                          |
| TP4 | GND2        | Ground                          |
| TP5 | IN1A        | H-bridge Input signal for OUT1A |
| TP6 | IN1B        | H-bridge Input signal for OUT1B |
| TP7 | IN2A        | H-bridge Input signal for OUT2A |
| TP8 | IN2B        | H-bridge Input signal for OUT2B |

#### 4.4.3 Input signal definitions

The motor drive IC has as many as five input signals that are used to control certain outputs or functions inside the circuit.

Table 5. Input signal definitions

| Name on board | Description                               |
|---------------|---|
| IN1A          | Controls OUT1A                            |
| IN1B          | Controls OUT1B                            |
| IN2A          | Controls OUT2A                            |
| IN2B          | Controls OUT2B                            |
| EN            | This signal enables output 1 and output 2 |

#### 4.4.4 Output signal definitions

The motor drive IC has four output signals that are used to drive a single DC stepper motor or two DC brushed motors.

Table 6. Output Signal Definitions

| Name  | Description                       |
|-------|-----------------------------------|
| OUT1A | H-bridge 1 driver output phase 1A |
| OUT1B | H-bridge 1 driver output phase 1B |
| OUT2A | H-bridge 2 driver output phase 2A |
| OUT2B | H-bridge 2 driver output phase 2B |

#### 4.4.5 Screw terminal connections

The board features screw terminal connections to allow easy access to device signals and supply rails.

**Table 7. Screw terminal connections**

| Name | Pin | Signal name | Signal description                                |
|------|-----|-------------|---|
| J5   | 1   | VPWR_IN     | Power input (5.0 V to 9.0 V)                      |
|      | 2   | GND         | Ground  |
| J6   | 1   | OUT1A       | Driver output 1A                                  |
|      | 2   | OUT1B       | Driver output 1B                                  |
| J7   | 1   | OUT2A       | Driver output 2A                                  |
|      | 2   | OUT2B       | Driver output 2B                                  |
| J8   | 1   | INT1        | Auxiliary MCU signal (interrupt)<br>Not populated |
|      | 2   | IO5         | Auxiliary MCU signal (GPIO)<br>Not populated      |
| J9   | 1   | AN2         | Auxiliary MCU signal (analog)<br>Not populated    |
|      | 2   | AN1         | Auxiliary MCU signal (analog)<br>Not populated    |

#### 4.4.6 Jumpers

The board features jumper connections as shown in [Table 8](#).

**Table 8. Jumpers**

| Name | Description   |
|------|---|
| JP1  | Fuse bypass (not populated)                           |
| JP2  | VPWR to VIN   |
| JP3  | VDD select (needs jumper on to power driver IC logic) |

## 5 FRDM-KL25Z Freedom Development Platform

The NXP Freedom development platform is a set of software and hardware tools for evaluation and development. It is ideal for rapid prototyping of microcontroller-based applications. The NXP Freedom KL25Z hardware, FRDM-KL25Z, is a simple, yet sophisticated design featuring a Kinetis L Series microcontroller, the industry's first microcontroller built on the ARM® Cortex®-M0+ core.

### 5.1 Connecting FRDM-KL25Z to the board

The kit may be used with many of the Freedom platform evaluation boards featuring Kinetis processors. The FRDM-KL25Z development platform has been chosen specifically to work with the kit because of its low cost and features. The FRDM-KL25Z

board makes use of the USB, built in LEDs, and I/O ports available with NXP’s Kinetis KL2x family of microcontrollers. The main functions provided by the FRDM-KL25Z are to allow control of a stepper motor using a PC computer over USB, and to drive the necessary inputs on the evaluation kit to operate the motor.

The board is connected to the FRDM-KL25Z using four dual row headers. The connections are shown in [Table 9](#).

**Table 9. Header connections**

| FRDM LV stepper motor |     |          | FRDM-KL25Z |     |             |
|-----------------------|-----|----------|------------|-----|-------------|
| Header                | Pin | Name     | Header     | Pin | Name        |
| JA1                   | 1   | AUX_INT1 | J1         | 2   | PTA1        |
| JA1                   | 2   | EN       | J1         | 4   | PTA2        |
| JA1                   | 3   |          | J1         | 6   | PTD4        |
| JA1                   | 4   |          | J1         | 8   | PTA12       |
| JA1                   | 5   |          | J1         | 10  | PTA4        |
| JA1                   | 6   | IN1A     | J1         | 12  | PTA5        |
| JA1                   | 7   | IN1B     | J1         | 14  | PTC8        |
| JA1                   | 8   |          | J1         | 16  | PTC9        |
|                       |     |          |            |     |             |
| JA2                   | 1   | IN2A     | J2         | 2   | PTA13       |
| JA2                   | 2   | IN2B     | J2         | 4   | PTD5        |
| JA2                   | 3   |          | J2         | 6   | PTD0        |
| JA2                   | 4   |          | J2         | 8   | PTD2        |
| JA2                   | 5   |          | J2         | 10  | PTD3        |
| JA2                   | 6   |          | J2         | 12  | PTD1        |
| JA2                   | 7   | GND      | J2         | 14  | GND         |
| JA2                   | 8   |          | J2         | 16  | VREFH       |
| JA2                   | 9   |          | J2         | 18  | PTE0        |
| JA2                   | 10  |          | J2         | 20  | PTE1        |
|                       |     |          |            |     |             |
| JA3                   | 8   | VIN      | J3         | 16  | P5-9V_VIN   |
| JA3                   | 7   | GND      | J3         | 14  | GND         |
| JA3                   | 6   | GND      | J3         | 12  | GND         |
| JA3                   | 5   |          | J3         | 10  | P5V_USB     |
| JA3                   | 4   | 3V3      | J3         | 8   | P3V3        |
| JA3                   | 3   |          | J3         | 6   | RESET/PTA20 |
| JA3                   | 2   |          | J3         | 4   | P3V3        |
| JA3                   | 1   |          | J3         | 2   | SDA_PTD5    |
|                       |     |          |            |     |             |
| JA4                   | 6   |          | J4         | 12  | PTC1        |



| FRDM LV stepper motor |     |         | FRDM-KL25Z |     |      |
|-----------------------|-----|---------|------------|-----|------|
| Header                | Pin | Name    | Header     | Pin | Name |
| JA4                   | 5   |         | J4         | 10  | PTC2 |
| JA4                   | 4   | AUX_IO5 | J4         | 8   | PTB3 |
| JA4                   | 3   |         | J4         | 6   | PTB2 |
| JA4                   | 2   | AUX_AN2 | J4         | 4   | PTB1 |
| JA4                   | 1   | AUX_AN1 | J4         | 2   | PTB0 |

## 6 Installing the software and setting up the hardware

The latest version of the Motor Control GUI is designed to run on any Windows 10, Windows 8, Windows 7, Vista, or XP-based operating system. To install the software, go to [www.nxp.com/analogtools](http://www.nxp.com/analogtools) and select your kit. Click on that link to open the corresponding tool summary page. Look for “Jump Start Your Design”. Download the Motor Control GUI software to your computer desktop (**LVMC-Steppermotor-setup.exe**).

Run the installed program from the desktop. The Installation Wizard guides you through the rest of the process.

To use the Motor Control GUI, go to the Windows Start menu, then Programs, then Motor Control GUI, and then click the NXP icon. The Motor Control Graphic User Interface (GUI) appears. The GUI is shown in [Figure 3](#). The hex address numbers at the top are loaded with the vendor ID for NXP (0x15A2), and the part ID (0x138). The panel on the left side displays these numbers only if the PC is communicating with the FRDM-KL25Z via the USB interface.



Figure 3. Motor Control GUI

### 6.1 Configuring the hardware

[Figure 4](#) and [Figure 5](#) show the configuration diagrams for single stepper motor and DC motors.

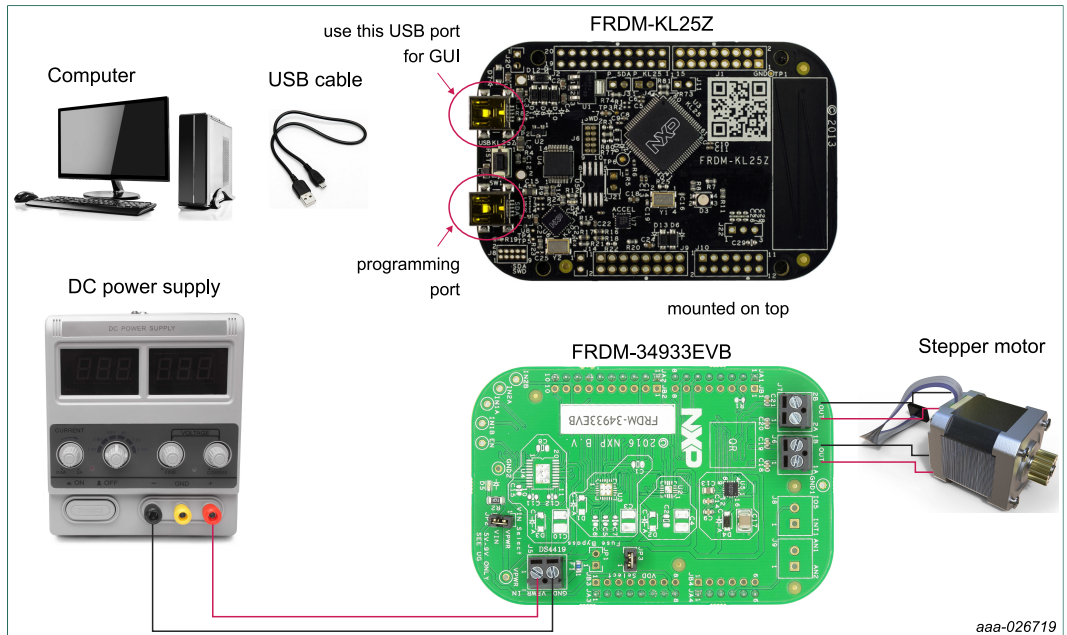

Figure 4. Setup for Stepper motor

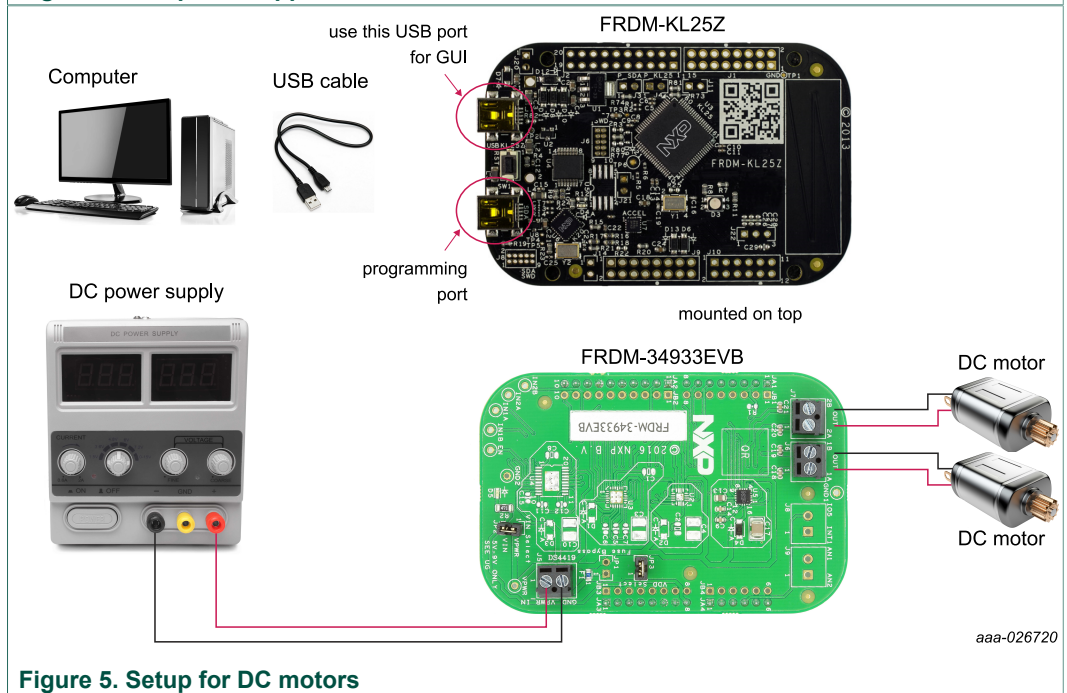

Figure 5. Setup for DC motors

## 6.2 Step-by-step instructions for setting up the hardware using Motor Control GUI

When using the board make sure that the following operating parameters are followed or damage may occur.

- The maximum motor supply voltage ( $V_M$ ) cannot exceed 7.0 V, and must be at least 3.3 V
- The nominal operating current of the stepper motor cannot exceed 1.0 A (1.4 A peak)

In order to perform the demonstration example, first set up the evaluation board hardware and software as follows:

1. Setup the FRDM-KL25Z to accept code from the mbed online compiler. mbed is a developer site for ARM based microcontrollers. The instructions are at mbed.org (<https://mbed.org/handbook/mbed-FRDM-KL25Z-Upgrade>). Switch to the other USB port (programming port) on the FRDM-KL25Z, and back after you load the project.
2. Go to the NXP page on mbed.org and look for the repository named "**LVHB Stepper Motor Drive**" (<https://developer.mbed.org/teams/NXP/code/LVHB-Stepper-Motor-Drive-v2>).
3. Import main.cpp source code into compiler.
4. Save the compiled code on your local drive, and then drag and drop it onto the mbed drive (which is the FRDM-KL25Z) while connected to the programming OpenSDA port. Move the USB connector back to the other USB port on the FRDM-KL25Z.  
Note: Create a user before you can download the code. Connect the board to the FRDM-KL25Z. This is best accomplished by soldering the female connectors to the FRDM-KL25Z, and then connecting to the male pins provided on the board.
5. Ready the computer and install the Stepper Motor Driver GUI software.
6. Attach DC power supply (without turning on the power) to the VM and GND terminals.
7. Attach one set of coils of the stepper motor to the OUT1A and OUT1B output terminals. Attach the other phase coil of the stepper motor to terminals OUT2A and OUT2B. Launch the Stepper Motor Driver GUI software.
8. Make sure the GUI recognizes the FRDM-KL25Z. This is determined by seeing the hex Vendor ID (0x15A2), and Part ID (0x138) under USB connection in the upper left-hand corner of the GUI. If the GUI does not recognize the FRDM-KL25Z, you need to disconnect and reconnect the USB cable to the FRDM-KL25Z.
9. Turn on the DC power supply.
10. Select **Enable Target** on the GUI. The demo is now ready to run.
11. Select Direction, Step Mode, and Acceleration Enabled.  
Acceleration enabled controls motor speed slowly increasing from stop to maximum number of steps selected by Step Time slider control.
12. Click **Run** to run the motor. Notice that some options of the GUI are disabled while the motor is running. To make changes, click **Stop** on the GUI, make the desired changes, and then click **Run** on the GUI to continue.
13. When finished, click **Enable Target** on the GUI, and then **Quit**. Turn off DC power supply. Remove USB cable.

### 6.3 Installing CodeWarrior

This procedure explains how to obtain and install the latest version of CodeWarrior (version 10.6 in this guide).

**Note:** *The sample software in this kit requires CodeWarrior 10.6 or newer. The component and some examples in the component package are intended for Kinetis Design Studio 3.0.0. If you have CodeWarrior 10.6 and Kinetis Design Studio 3.0.0 already installed on your system, skip this section.*

1. Obtain the latest CodeWarrior installer file from the NXP CodeWarrior website: <http://www.nxp.com/CODEWARRIOR>.
2. Run the executable file and follow the instructions.
3. In the Choose Components window, select the Kinetis component, and then click **Next** to complete the installation.

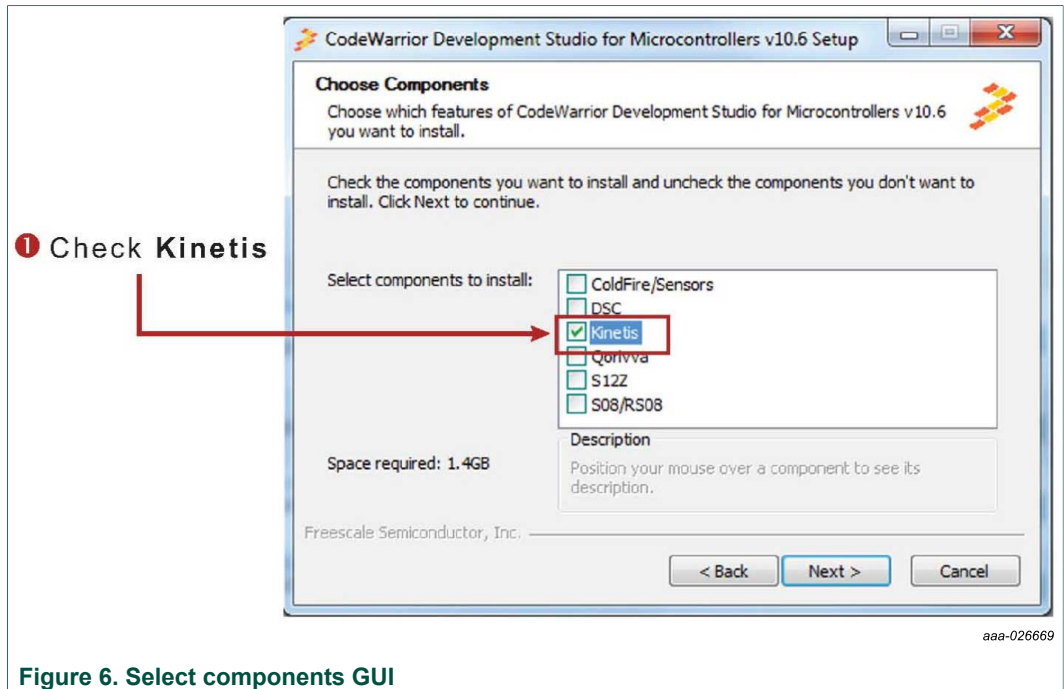

**Figure 6. Select components GUI**

### 6.4 Downloading the LVHBridge component and example projects

The examples used in this section are based on a preconfigured CodeWarrior project. You must first download the project and its associated components:

1. Go to the NXP website: [www.nxp.com/LVHBRIDGE-PEXPERT](http://www.nxp.com/LVHBRIDGE-PEXPERT).
2. Download example projects and H-bridge component zip file.
3. Unzip the downloaded file and make sure the folder contains the files listed in [Table 10](#).

**Table 10. LVHBridge example project and components**

| Folder name                 | Folder contents   |
|-----------------------------|---|
| <b>CodeWarrior_Examples</b> | Example project folder for CodeWarrior  |
| LVH_KL25Z_brush_MC34933     | Example project for DC brush motor control using FRDM-34933EVB H-bridge board and FRDM-KL25Z MCU board                                      |
| LVH_KL25Z_brush_MPC17510    | Example project for DC brush motor control using FRDM-17510EVB H-bridge board and FRDM-KL25Z MCU board                                      |
| LVH_KL25Z_stepper           | Example project intended to control stepper motor using FRDM-34933EVB H-bridge board and FRDM-KL25Z MCU board                               |
| LVH_KL25Z_stepper_ramp      | Example project intended to control stepper motor using FRDM-34933EVB H-bridge board and FRDM-KL25Z MCU board. Acceleration ramp is enabled |
| <b>Component</b>            | Processor Expert component folder   |
| <b>KDS_Examples</b>         | Example project folder for Kinetis Design Studio 3.0.0 or newer   |
| LVH_K20D50M_brush_MC34933   | Example project for DC brush motor control using FRDM-34933EVB H-bridge board and FRDM-K20D50M MCU board                                    |
| LVH_K20D50M_brush_MPC17510  | Example project for DC brush motor control using FRDM-17510EVB H-bridge board and FRDM-K20D50M MCU board                                    |

| Folder name                    | Folder contents   |
|--------------------------------|---|
| LVH_K20D50M_stepper_bitIO      | Example project intended to control stepper motor using FRDM-34933EVB H-Bridge board and FRDM-K20D50M MCU board   |
| LVH_K20D50M_stepper_ramp_bitIO | Example project intended to control stepper motor using FRDM-34933EVB H-bridge board and FRDM-K20D50M MCU board. Acceleration ramp is enabled   |
| LVH_KL25Z_brush_MC34933        | Example project for DC brush motor control using FRDM-34933EVB H-bridge board and FRDM-KL25Z MCU board  |
| LVH_KL25Z_brush_MPC17510       | Example project for DC brush motor control using FRDM-17510EVB H-bridge board and FRDM-KL25Z MCU board  |
| LVH_KL25Z_brush_FreeMASTER     | Example project intended to control DC brush motor using FreeMASTER tool. Latest Freemaster installation package: <a href="http://www.nxp.com/freemaster">http://www.nxp.com/freemaster</a> |
| LVH_KL25Z_step_FreeMASTER      | Example project intended to control stepper motor using FreeMASTER tool   |
| LVH_KL25Z_stepper              | Example project intended to control stepper motor using FRDM-34933EVB H-bridge board and FRDM-KL25Z MCU board   |
| LVH_KL25Z_stepper_ramp         | Example project intended to control stepper motor using MC34933 H-bridge freedom board and FRDM-KL25Z MCU board. Acceleration ramp is enabled.  |
| LVH_KL26Z_stepper              | Example project intended to control stepper motor using FRDM-34933EVB H-bridge board and FRDM-KL26Z MCU board   |
| LVH_KL26Z_stepper_iar          | Example project intended to control stepper motor using FRDM-34933EVB H-bridge board and FRDM-KL26Z MCU board. IAR compiler is used instead of GNU C compiler.                              |

#### 6.4.1 Import the LVHBridge component into Processor Expert library

1. Launch CodeWarrior by clicking the CodeWarrior icon (located on your desktop or in Program Files -> NXP Codewarrior folder.)
2. When the CodeWarrior IDE opens, go to the menu bar and click **Processor Expert** -> **Import Component(s)**.
3. In the pop-up window, locate the component file (.PEupd) in the example project folder LVHBridge\_PEx\_SW\Component.
4. Select LVHBridge\_b1508.PEupd and ChannelAllocator\_b1508.PEupd files, and then click **Open**.

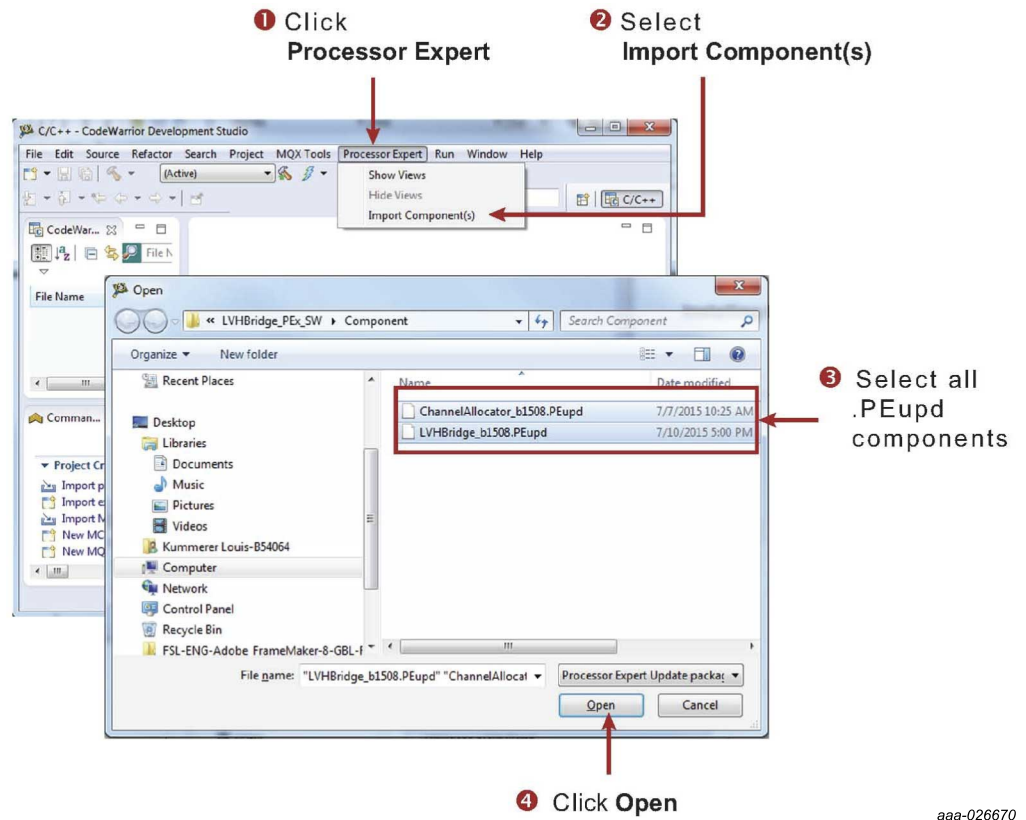

- 5. If the import is successful, the LVHBridge component appears in Components Library -> SW -> User Component.

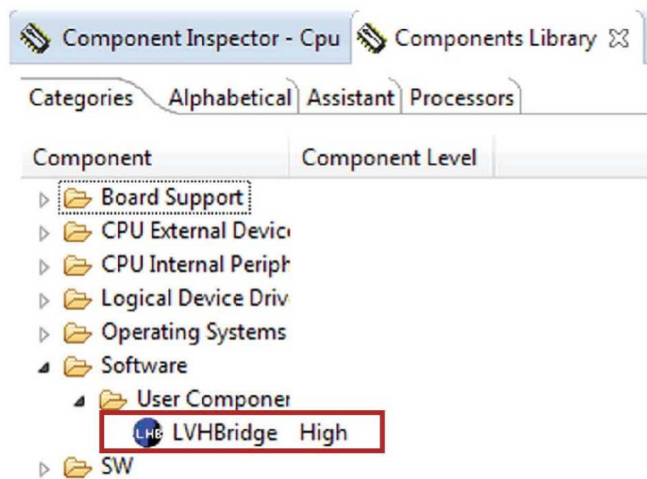

Note that the component ChannelAllocator is not visible, because it is not designed to be accessible.

The LVHBridge component is ready to use.

**6.4.2 Import an example project into CodeWarrior**

The following steps show how to import an example project from the downloaded zip file into CodeWarrior.

1. In the CodeWarrior menu bar, click **File -> Import...**
2. In the pop-up window, select **General -> Existing Projects into Workspace**, and then click **Next**.
3. Locate the example in folder: LVHBridge\_PEx\_SW\CodeWarrior\_Examples (LVH\_KL25Z\_brush\_MC34933). Then click **Finish**.

The project is now in the CodeWarrior workspace where you can build and run it.

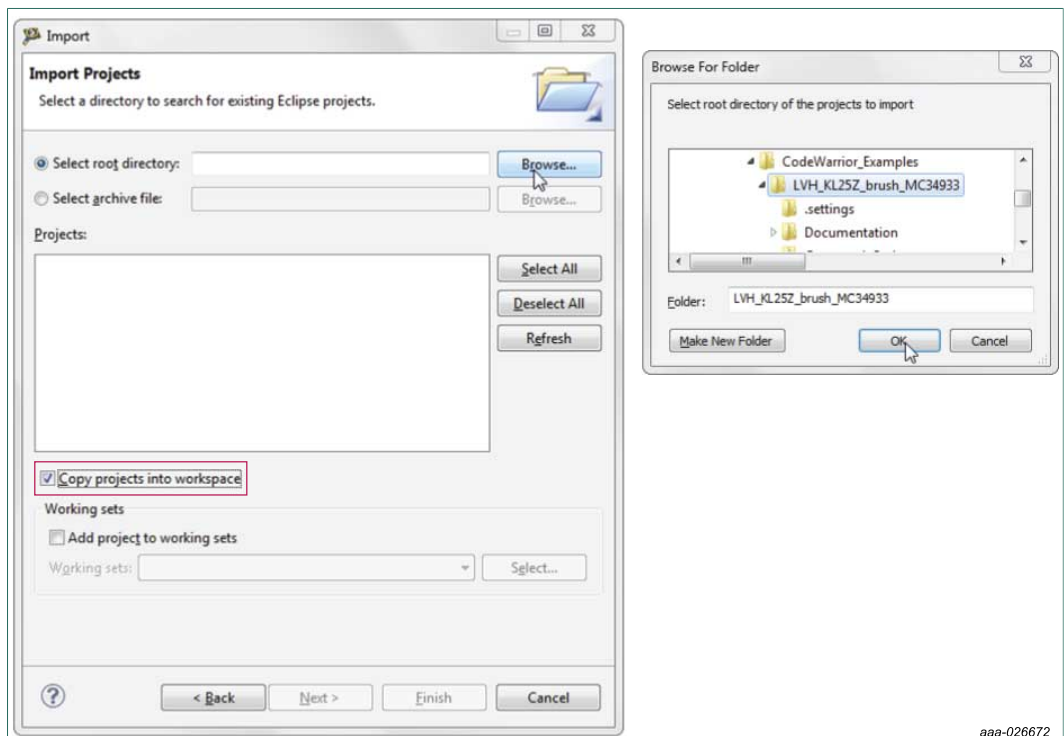

**Figure 7. Example project import**

aaa-026672

**6.5 Create a new project with Processor Expert and LVHBridge component**

If you choose not to use an example project, the following instructions describe how to create and setup a new project that uses the LVHBridge component. If you do not have the LVHBridge component in the Processor Expert library, please follow steps in [Section 6.4.1 "Import the LVHBridge component into Processor Expert library"](#).

1. Create and name an MCU Bareboard project.

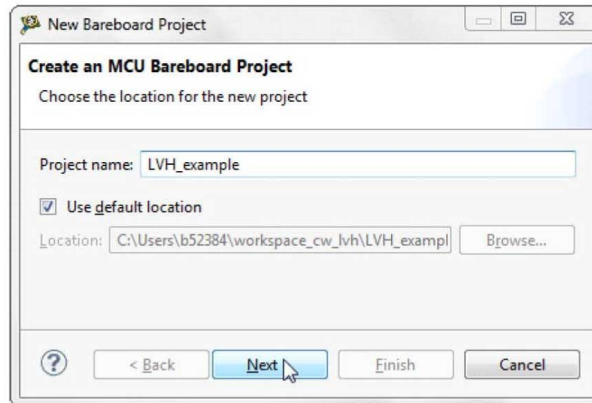

aaa-026673

2. Choose the MCU class to be used in the freedom MCU board (MKL25Z128 in this example). Then select the connections to be used.

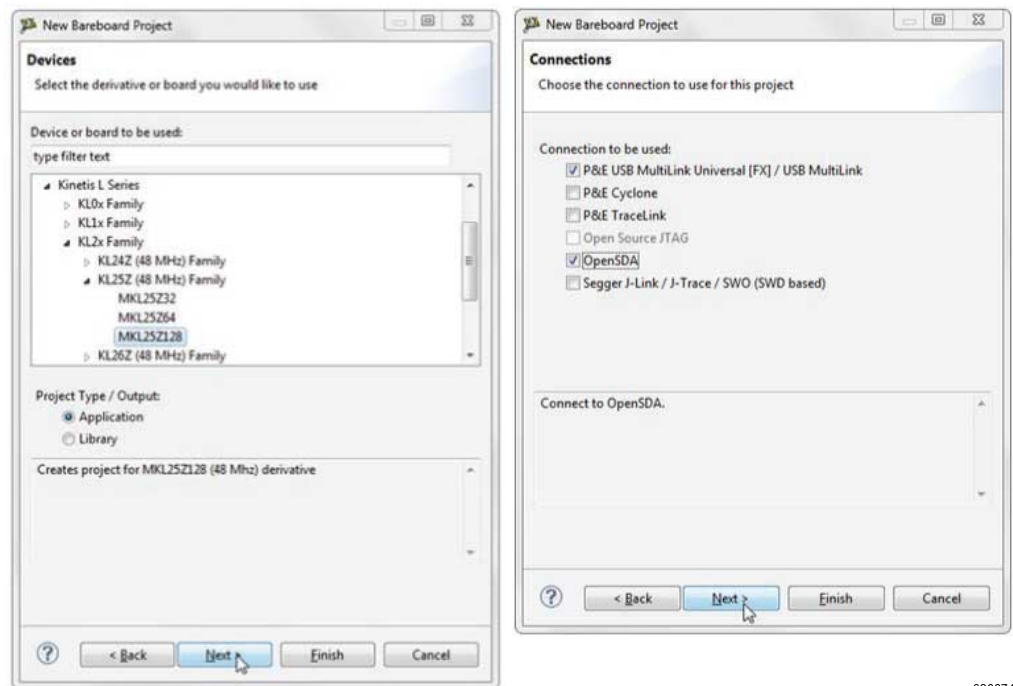

aaa-026674

3. Select the **Processor Expert** option, and then click **Finish**.



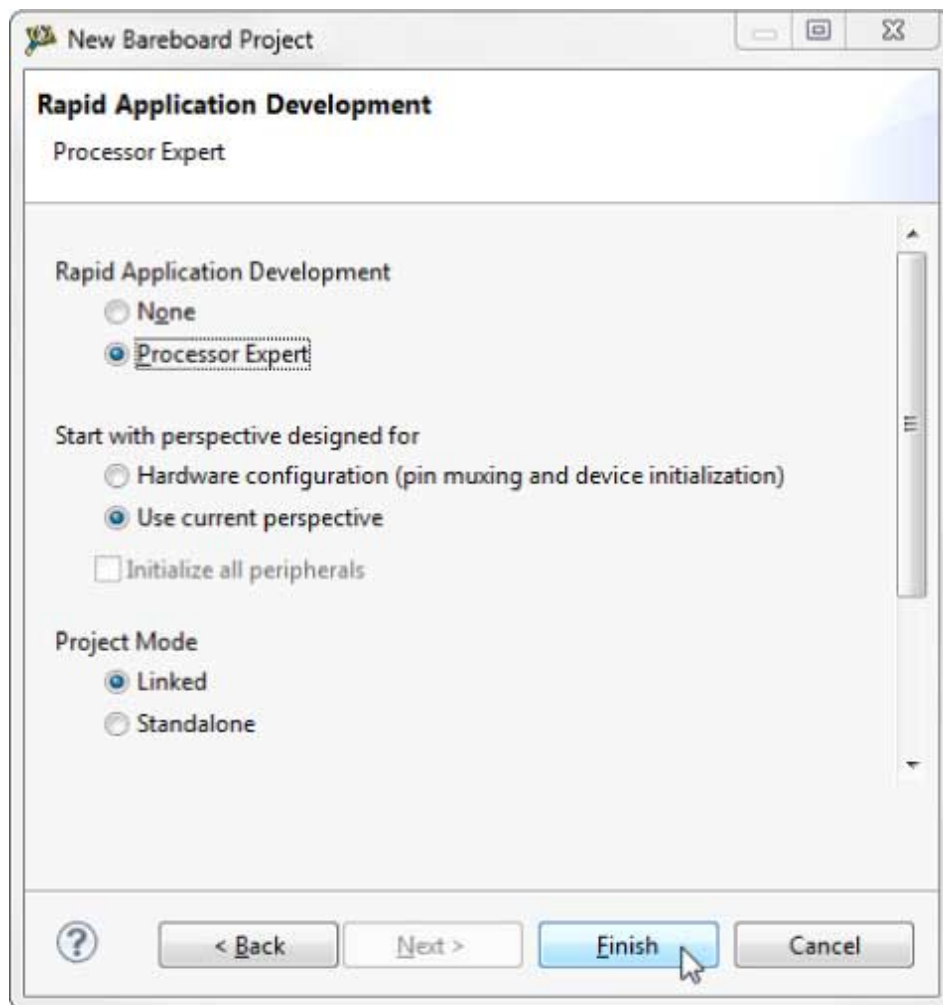

aaa-026675

## 6.5.1 Add LVHBridge component to the project

1. Find LVHBridge in the Components library and add to your project.

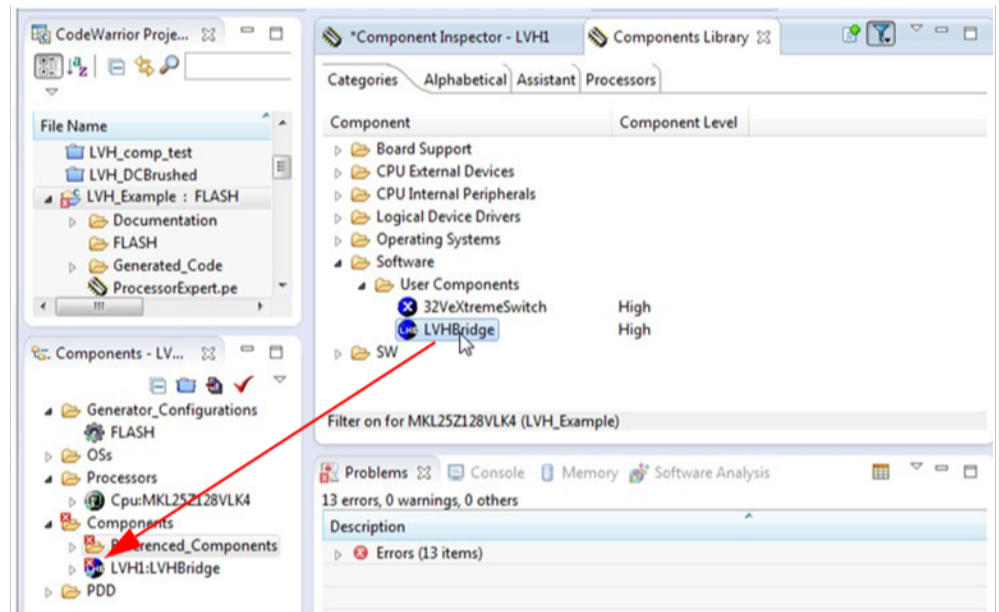

aaa-026676

2. Double-click **LVHBridge** component in the Components window to show the configuration in the Component Inspector view.

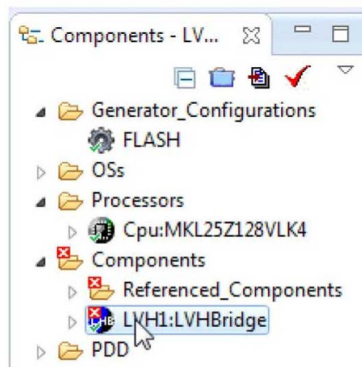

aaa-026677

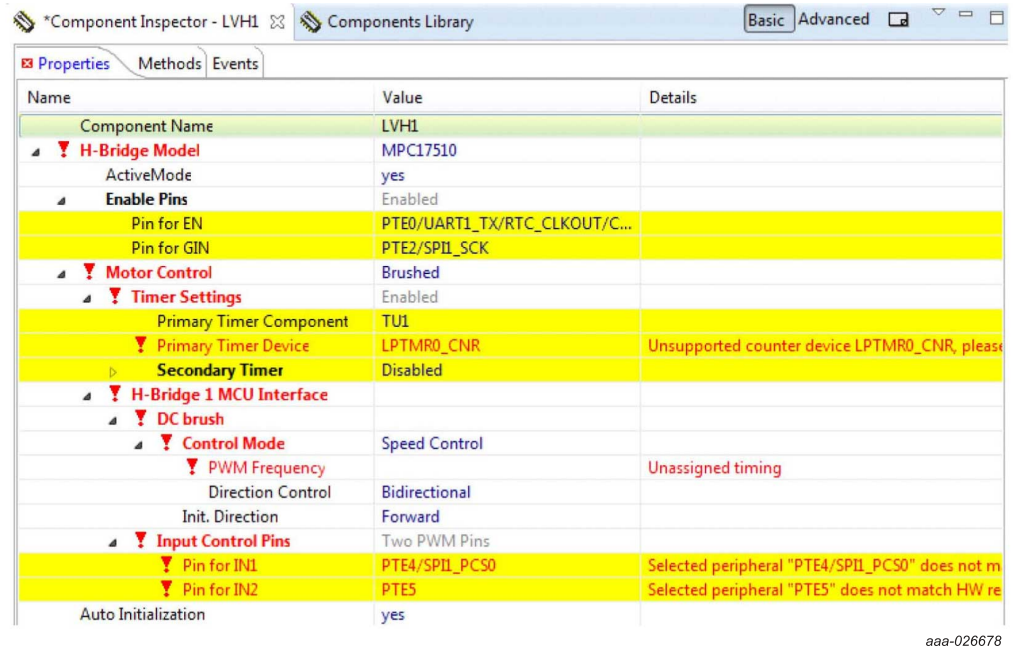

### 6.5.2 General settings of LVHBridge component

H-bridge model is on top of the tree structure in the Component Inspector view.

ActiveMode defines the H-bridge device operational mode (normal or power-conserving sleep mode), which is controlled by the enabling pin. Selection of the enabling pin is in the Enable Pins group. For more information, see H-bridge model’s data sheet. The mode can be changed using the C code method SetMode.

The Motor Control group involves timer settings, H-bridge device and motor control settings.

The Timer Settings group contains the Primary Timer Component property (the name of a linked TimerUnit\_LDD component) and the name of the hardware timer being used (defined in the Primary Timer Device property). Secondary Timer encompasses the properties of an additional timer.

Note that the Secondary Timer Component property must use a different TimerUnit\_LDD component than the Primary Timer Component property. The purpose of the primary and secondary timer is to allow the input control pins of an H-bridge device to be connected to different timers (this applies for some freedom H-bridge boards and freedom MCUs). But these timers must be synchronized to control a stepper motor. So the primary timer is designed to be the source for the global time base and the secondary timer is synchronized with the primary timer. See MCU data sheet to find out which timer provides the global time base (GTB) and set the Primary Timer Device property accordingly. An example of a timer selection using the FRDM-KL25Z MCU is shown in [Figure 8](#). If you are using a single timer, set the Secondary Timer Component to Disabled.

|                           |          |          |
|---------------------------|----------|----------|
| ▲ <b>Timer Settings</b>   | Enabled  |          |
| Primary Timer Component   | TU1      |          |
| Primary Timer Device      | TPM1_CNT | TPM1_CNT |
| ▲ <b>Secondary Timer</b>  | Enabled  |          |
| Secondary Timer Component | TU2      |          |
| Secondary Timer Device    | TPM0_CNT | TPM0_CNT |

aaa-026679

Figure 8. Selection of a FRDM-KL25Z MCU primary and a secondary timer device

H-bridge 1 MCU Interface and H-bridge 2 MCU Interface allow you to set H-bridge control function. The H-bridge 2 MCU Interface is shown only for dual H-bridge models (for example MC34933). The DC Brush group is described in [Section 6.5.3 "Setting up a project to control a DC brushed motor"](#). The Input Control Pins allow you to select the H-bridge input control pins that utilize the timer’s channels or GPIO pins.

|                                   |                                 |            |
|-----------------------------------|---------------------------------|------------|
| ▲ <b>H-Bridge 1 MCU Interface</b> |                                 |            |
| ▲ DC brush                        |                                 |            |
| ▲ Control Mode                    | Speed Control                   |            |
| PWM Frequency                     | 10 kHz                          | 10.001 kHz |
| Direction Control                 | Bidirectional                   |            |
| Init. Direction                   | Forward                         |            |
| ▲ Input Control Pins              | Two PWM Pins                    |            |
| Pin for IN1A                      | PTD4/LLWU_P14/SPI1_PCS0/UART... |            |
| Pin for IN1B                      | PTA12/TPM1_CH0                  |            |
| ▲ <b>H-Bridge 2 MCU Interface</b> |                                 |            |
| ▲ DC brush                        |                                 |            |
| Control Mode                      | State Control                   |            |
| Init. Direction                   | Forward                         |            |
| ▲ Input Control Pins              | Two GPIO Pins                   |            |
| Pin for IN2A                      | TS10_CH5/PTA4/I2C1_SDA/TPM0_... |            |
| Pin for IN2B                      | PTA5/USB_CLKIN/TPM0_CH2         |            |
| Auto Initialization               | yes                             |            |

aaa-026680

Figure 9. LVHBridge component - general settings

### 6.5.3 Setting up a project to control a DC brushed motor

1. Select the H-bridge model you want to configure and set the Motor Control property to Brushed.

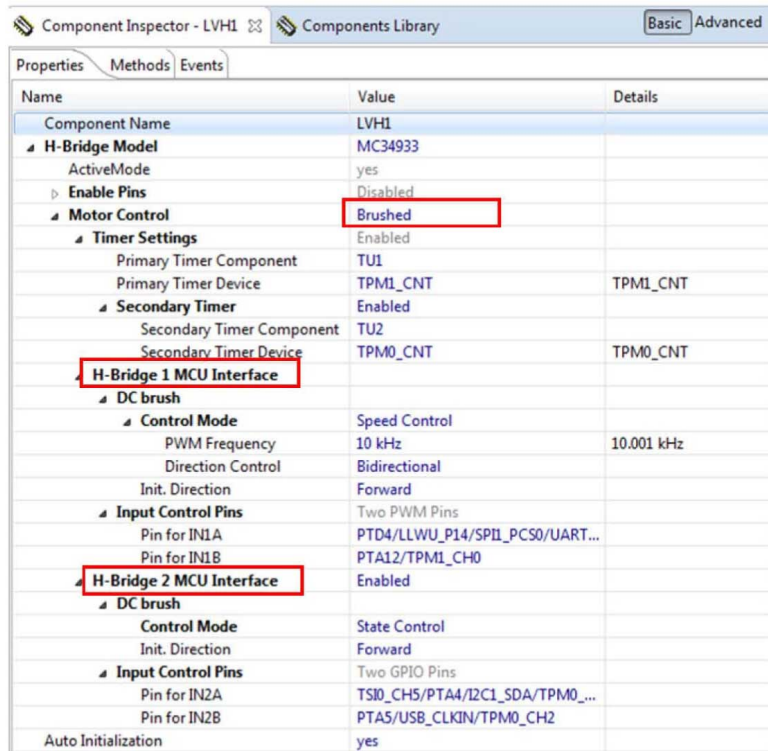

aaa-026681

2. Set the Control Mode property. There are two ways to control the DC brushed motor:
  - Speed control - motor speed is controlled by your settings. The TimerUnit\_LDD component is used to generate the PWM signal. The PWM Frequency property is visible in this mode only. If you set the Speed Control mode on both interfaces (Interface 1 and Interface 2), the PWM Frequency property on Interface 2 sets automatically to the same value as Interface 1 (because Interface 2 uses the same timer).
  - State control - motor is controlled by GPIO pins (BitIO\_LDD components). This means you can switch the motor on or off without speed adjustments. The advantage of this mode is that you do not need timer channels. If you set State Control on both interfaces or you have only a single H-bridge model (one interface) with State Control, the TimerUnit\_LDD component is not required anymore by the LVHBridge component and you can remove it from the project.
3. Set the PWM Frequency.
4. Set the Direction Control property.
 

The Direction Control property determines what direction the motor is allowed to move in. Setting the property to Forward restricts the motor's movement in the forward direction only. Setting the property to Reverse restricts movement in the reverse direction only. A Bidirectional setting allows the motor to move in either direction. The Bidirectional mode requires two timer channels. Forward or reverse requires only one timer channel and one GPIO port. This setting is available only when Speed Control mode is set in the Control Mode property.

**6.5.4 Setting up a project to control a stepper motor**

Select the dual H-bridge model you want to configure and set Stepper in the Motor Control property. Note that the dual H-bridge model is required, because a two phase bipolar stepper motor has four inputs.

| Name                            | Value                           | Details    |
|---------------------------------|---------------------------------|------------|
| Component Name                  | LVH1                            |            |
| <b>H-Bridge Model</b>           | MC34933                         |            |
| ActiveMode                      | yes                             |            |
| Enable Pins                     | Disabled                        |            |
| <b>Motor Control</b>            | Stepper                         |            |
| <b>Timer Settings</b>           | Enabled                         |            |
| Primary Timer Component         | TU1                             |            |
| Primary Timer Device            | TPM1_CNT                        | TPM1_CNT   |
| <b>Secondary Timer</b>          | Enabled                         |            |
| Secondary Timer Component       | TU2                             |            |
| Secondary Timer Device          | TPM0_CNT                        | TPM0_CNT   |
| <b>Stepper Motor</b>            |                                 |            |
| Output Control                  | PWM                             |            |
| <b>Motor Control Mode</b>       | Full-step and Micro-step        |            |
| <b>Full-step Configuration</b>  |                                 |            |
| Speed                           | 100                             | D          |
| Acceleration                    | 400                             | D          |
| <b>Micro-step Configuration</b> |                                 |            |
| PWM Frequency                   | 20 kHz                          | 20.011 kHz |
| Micro-steps per Step            | 8 Micro-steps                   |            |
| Speed                           | 400                             | D          |
| Acceleration                    | 400                             | D          |
| <b>H-Bridge 1 MCU Interface</b> |                                 |            |
| <b>Input Control Pins</b>       | Two PWM Pins                    |            |
| Pin for IN1A                    | PTD4/LLWU_P14/SPI1_PCS0/UART... |            |
| Pin for IN1B                    | PTA12/TPM1_CH0                  |            |
| <b>H-Bridge 2 MCU Interface</b> | Enabled                         |            |
| <b>Input Control Pins</b>       | Two PWM Pins                    |            |
| Pin for IN2A                    | TSI0_CH5/PTA4/I2C1_SDA/TPM0_... |            |
| Pin for IN2B                    | PTA5/USB_CLKIN/TPM0_CH2         |            |
| Auto Initialization             | yes                             |            |

aaa-026682

**Figure 10. Component settings to control a stepper motor**

In the Stepper Motor group, set the properties that apply to your environment.

- The Output Control property defines the control method.
  - With PWM selected the component utilizes four channels of a timer to control the stepper motor. Signal is generated in hardware and micro-step mode is also available.
  - In GPIO mode, GPIO pins are used instead of timer channels and only full-step mode is available (no micro-step mode).
- Manual Timer setting property is only visible when you switch the visibility of the component properties to Advanced. It is designed to change the Counter frequency

of the linked TimerUnit\_LDD component. By default the Counter frequency is set automatically by LVHBridge component. In some cases the frequency value does not have to be set appropriately (user wants to set a different value or an error has occurred). For more information see [Section 6.5.5 "Stepper motor speed"](#).

- Motor Control Mode allows you to select the step mode. Selecting full-step and micro-step mode allows you to switch between full-stepping and micro-stepping in C code.
  - Full-step configuration contains speed and acceleration settings. Code for the acceleration and deceleration ramp is generated when the Acceleration property is set to a value greater than zero. Note that acceleration is always the same as deceleration. The acceleration setting is 400, as shown in [Figure 10](#).
    - Desired motor speed is set to 100 full-steps per second. This value is defined by the speed property in Processor Expert GUI and can be changed in C code.
    - Acceleration and deceleration is set to 400 full-steps per second. This value is defined by the Acceleration property. Note that the motor reaches the speed in 0.25 second<sup>2</sup> (desired\_speed / acceleration = 100 / 400 = 0.25).

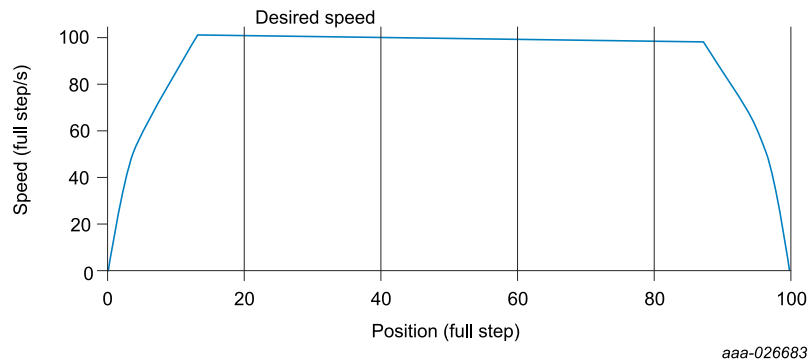

- Micro-step configuration settings are similar to those of the full-step configuration. PWM frequency is the frequency of the micro-step PWM signal. Micro-step per step is the number of micro-steps per one full-step.

**6.5.5 Stepper motor speed**

The LVHBridge component defines the stepper motor’s minimum and maximum speed. These limit values are used by the component methods. Minimum speed in full-step and micro-step modes is one step per second. Maximum speed is 5000 steps per second. There is a specific case when minimum full-step speed is affected by timer input frequency. In this case the Primary Timer Device property must use FTM timer values (FTM0\_CNT, or FTM1\_CNT). The Secondary Timer property must be set to Disabled. The Stepper Motor Output Control property must be set to PWM. [Figure 11](#) illustrates this configuration.

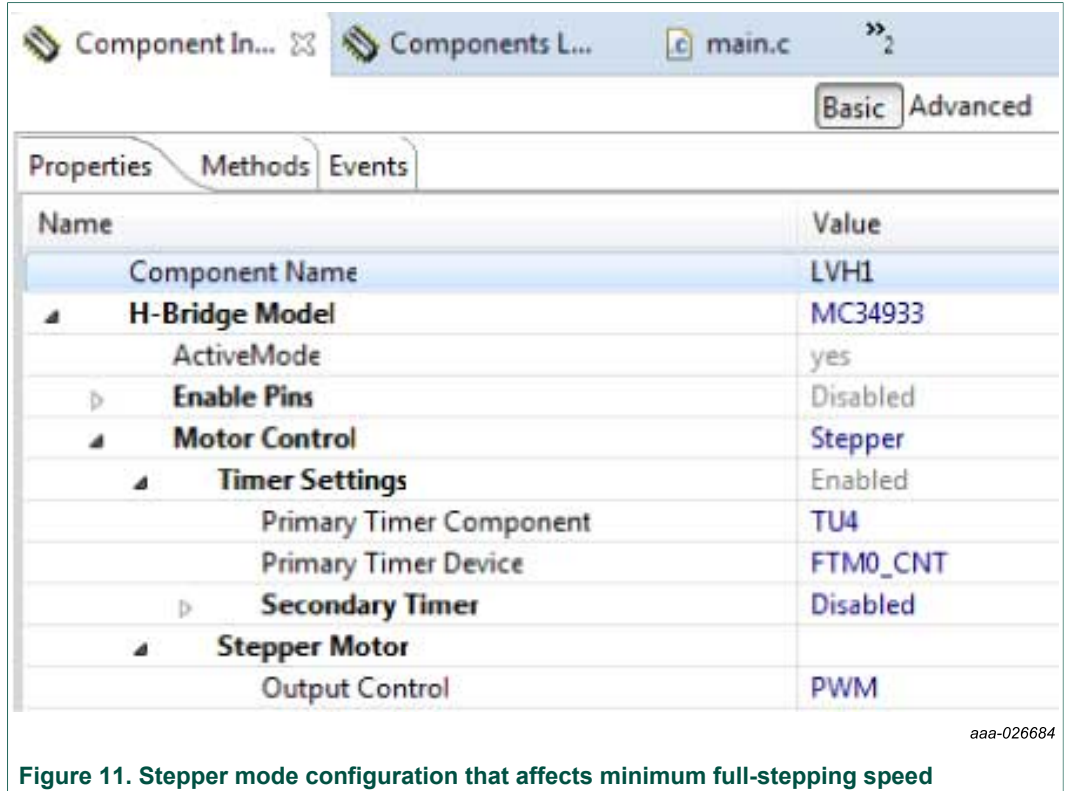

Figure 11. Stepper mode configuration that affects minimum full-stepping speed

Possible values for the timer input frequency (counter frequency property in TimerUnit\_LDD) are shown in Table 11. Input frequency values depend on LVHBridge component settings. Note that two frequency values are needed in "full-step and micro-step mode". In one case LVHBridge component switches in runtime between these two values.

Table 11. Minimum and maximum timer input frequency per stepper control mode

| Mode description              | LVHBridge component properties |                 |                |                          | Primary timer input frequency |                                  |                                | Secondary timer input frequency      |
|-------------------------------|--------------------------------|-----------------|----------------|--------------------------|-------------------------------|----------------------------------|--------------------------------|--------------------------------------|
|                               | Timer device                   | Secondary timer | Output control | Motor control mode       | Values                        | Min.                             | Max.                           |                                      |
| Full-step mode                | TPM                            | Don't care      | PWM            | Full-step                | 1                             | 131 kHz                          | 1.0 MHz                        | Any value (user selection)           |
| Full-step and micro-step mode | TPM                            | Don't care      | PWM            | Full-step and micro-step | 1                             | 1.2 MHz                          | 10 MHz                         | Any value (user selection)           |
| Full-step mode (SW control)   | FTM or TPM                     | Disabled        | GPIO           | Full-step                | 1                             | 131 kHz                          | 1.0 MHz                        | Secondary timer is not enabled       |
| Full-step mode                | FTM                            | Disabled        | PWM            | Full-step                | 1                             | 131 kHz                          | 1.0 MHz                        | Secondary timer is not enabled       |
| Full-step mode                | FTM                            | Enabled         | PWM            | Full-step                | 1                             | 131 kHz                          | 1.0 MHz                        | The same values as for primary timer |
| Full-step and micro-step mode | FTM                            | Disabled        | PWM            | Full-step and micro-step | 2                             | 1st value for full-step: 131 kHz | 1st value for Full-step: 1 MHz | Secondary timer is not enabled       |



| Mode description              | LVHBridge component properties |                 |                |                    | Primary timer input frequency |                                   |                                  | Secondary timer input frequency      |
|-------------------------------|--------------------------------|-----------------|----------------|--------------------|-------------------------------|-----------------------------------|----------------------------------|--------------------------------------|
|                               | Timer device                   | Secondary timer | Output control | Motor control mode | Values                        | Min.                              | Max.                             |                                      |
|                               |                                |                 |                |                    |                               | 2nd value for micro-step: 1.2 MHz | 2nd value for Micro-step: 10 MHz |                                      |
| Full-step and micro-step mode | FTM                            | Enabled         | PWM            | Full-step          | 1                             | 1.2 MHz                           | 10 MHz                           | The same values as for primary timer |

**6.5.5.1 Computation of minimum full-stepping speed**

The minimum full-stepping speed depends on the timer input frequency only when the Primary Timer Device is set to FTM (FTM0\_CNT, or FTM1\_CNT), the Secondary Timer property is disabled and Output Control is set to PWM. The full-step signal is generated by a timer while channels toggle on compare (see [Figure 12](#)).

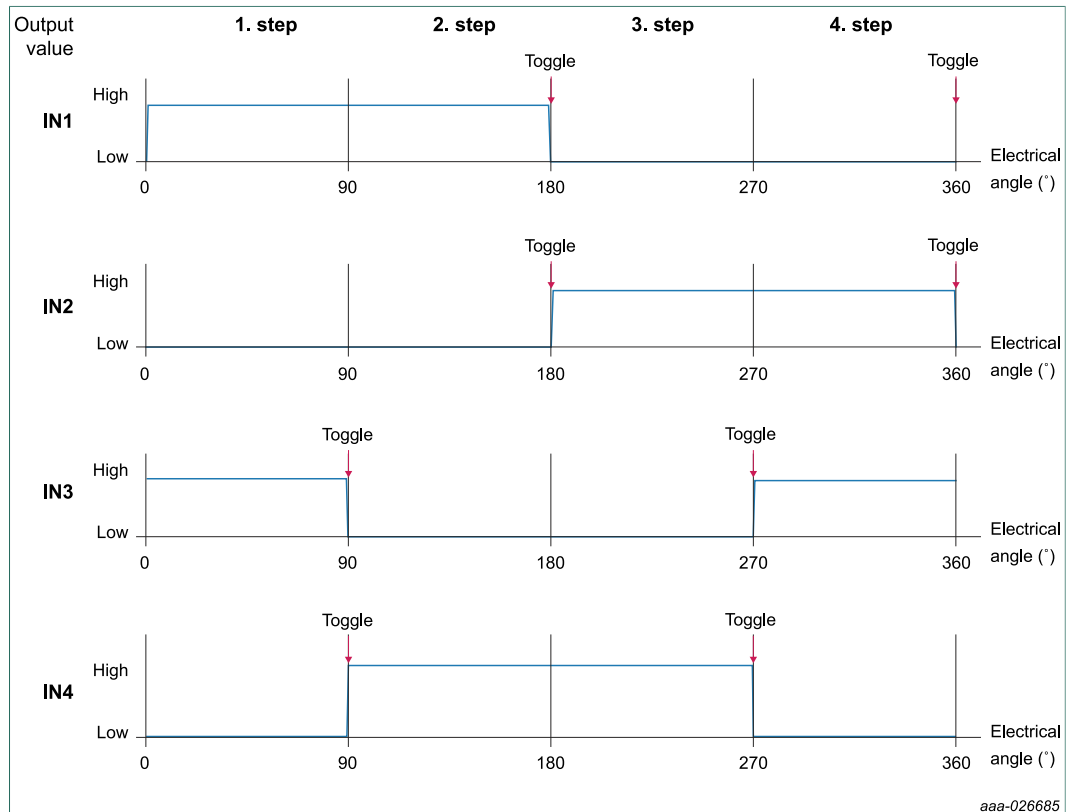

**Figure 12. Generating the full-step control signal**

The full-step minimum speed is derived from the input frequency of the timer device (the counter frequency property of the TimerUnit\_LDD component being used). You can find minimum values for speed in the LVHBridge header file (see constant <component\_name>\_MIN\_FULLSTEP\_SPEED). The formula for calculation of this value is as follows:

$$Speed_{min} = \frac{2 \times Counter\_frequency}{65536} + 1$$

where:

Counter\_frequency = input frequency of the timer device

65536 = maximum value of TimerUnit\_LDD counter (16-bit counter)

Adding 1 ensures that the 16-bit counter does not overflow (which is the point of the formula)

For example if the Counter frequency is set to 187,500 Hz, the minimum speed is:

$$Speed_{min} = \frac{2 \times Counter\_frequency}{65536} + 1 = \frac{2 \times 187500}{65536} + 1 = 6.72$$

The MCU rounds the value down, so the result is 6 full-steps per second.

#### 6.5.5.2 Setting the minimum full-stepping speed

This section describes how to change the input frequency of the TimerUnit\_LDD component.

1. Launch Processor Expert and select the LVHBridge component.
2. In the Processor Expert menu bar, set component visibility to **Advanced**.
3. In the Properties tab, find the **Motor Control** -> **Stepper Motor** -> **Manual timer** setting property and set the value to **Enabled**. If you do not see this property, make sure that component visibility is set to Advanced (see [Figure 13](#)).
4. Set the TimerUnit\_LDD frequency:
  - a. In the Components view, double-click the **TimerUnit\_LDD** component.
  - b. Press the button in the Counter frequency field.
  - c. Set the frequency value (187.5 kHz in the illustration). The list of available frequencies depends on the CPU component settings (with an external crystal as the clock source and a core clock of 48 MHz).
  - d. Set the Allowed Error value at 10 % (see [Figure 15](#)).

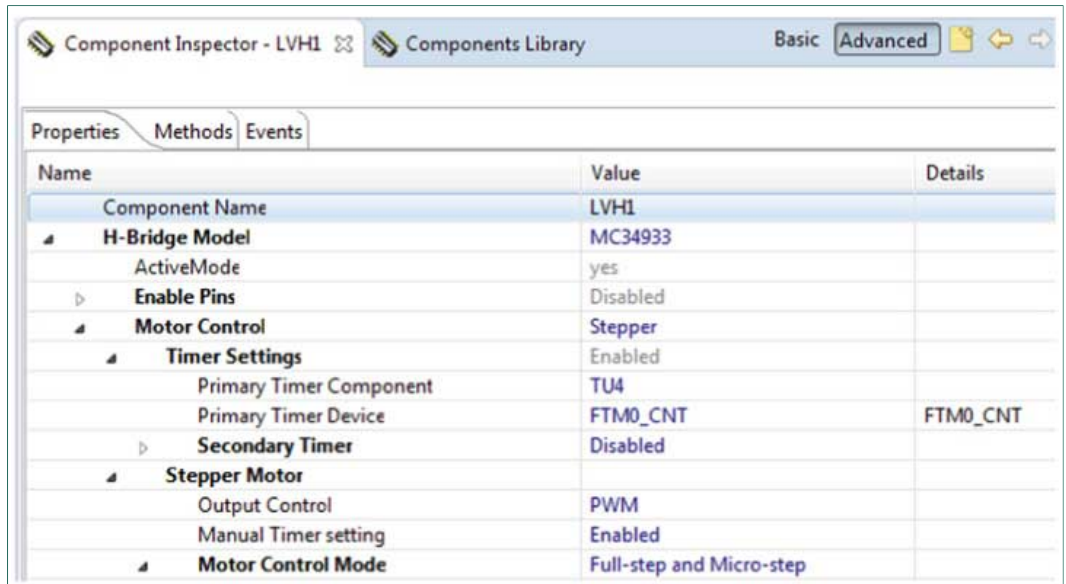

aaa-026686

Figure 13. Enabling the manual frequency setting

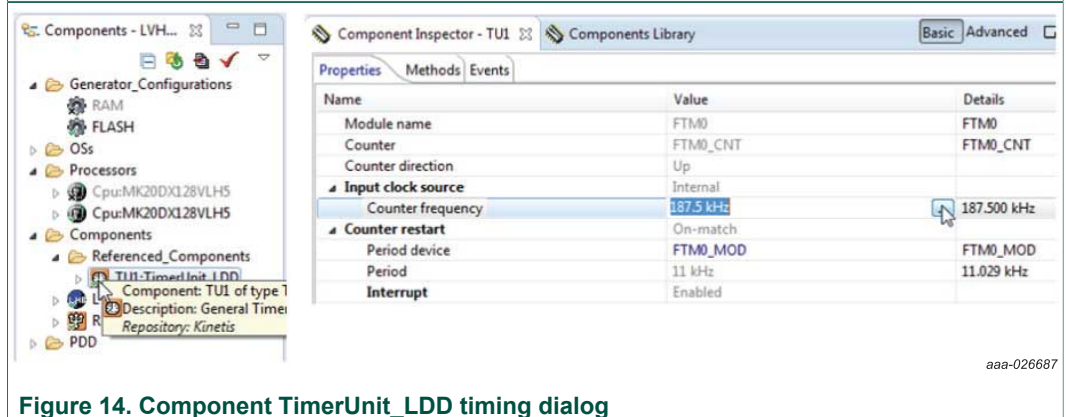

aaa-026687

Figure 14. Component TimerUnit\_LDD timing dialog

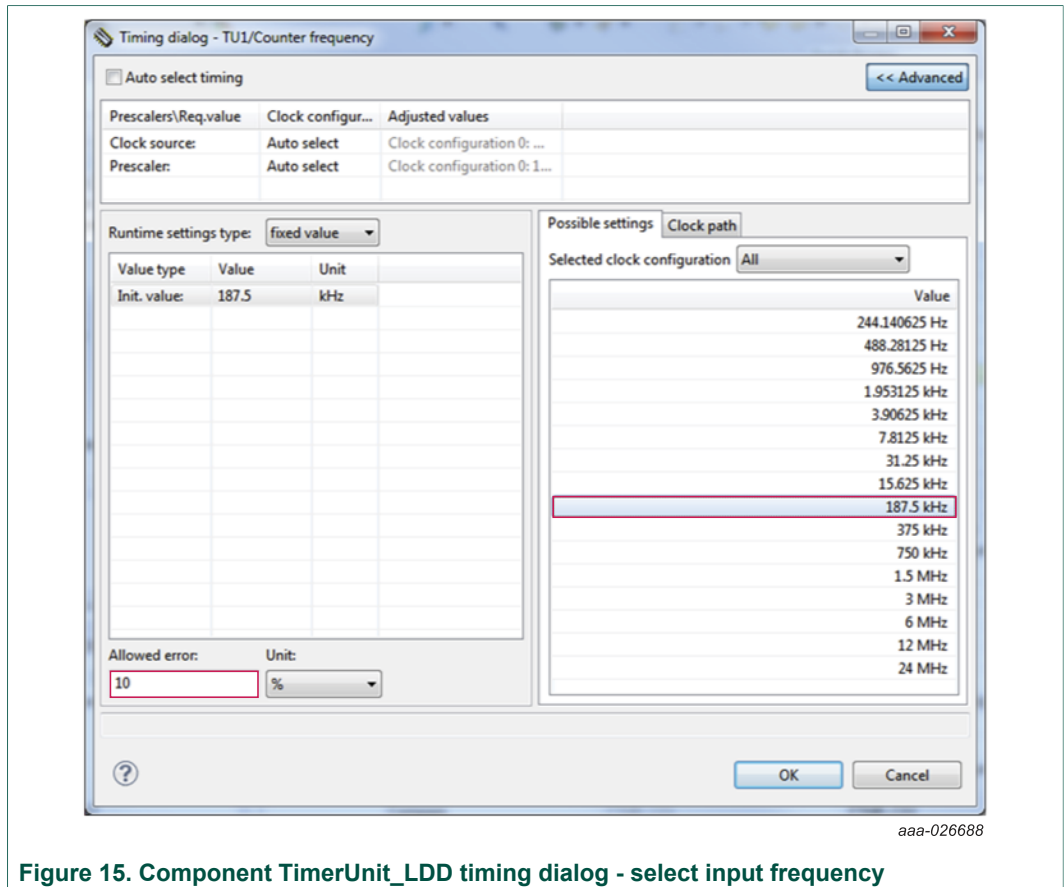

Figure 15. Component TimerUnit\_LDD timing dialog - select input frequency

### 6.5.6 Generating application code

After configuration, generate the source code by clicking the icon in the upper right corner of the Components screen.

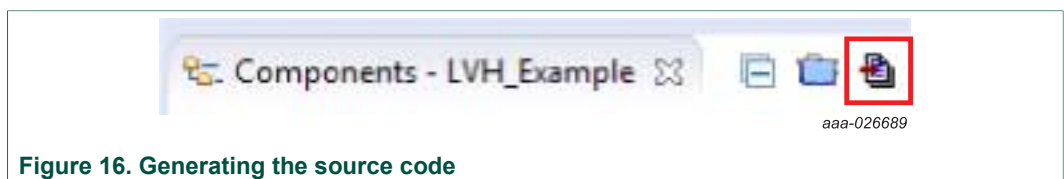

Figure 16. Generating the source code

The driver code for the H-bridge device is generated in the Generated\_Code folder in the project view. The component only generates application driver code. It does not generate application code.

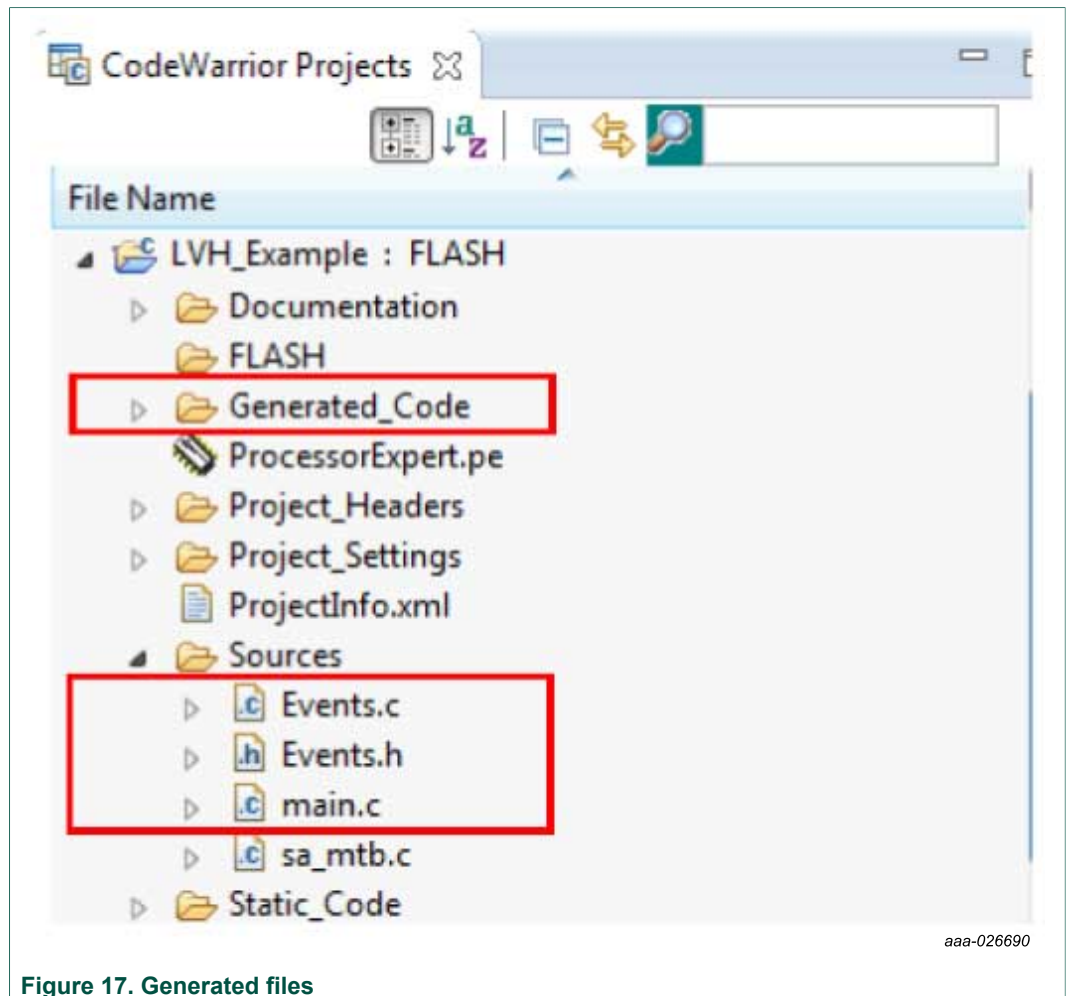

Figure 17. Generated files

### 6.5.7 Using the interface

Application code can be written and tested in the project. For example, you can open the LVHBridge component method list, drag and drop RotateProportional to main.c (see [Figure 18](#)), add any necessary parameters, then compile the program.

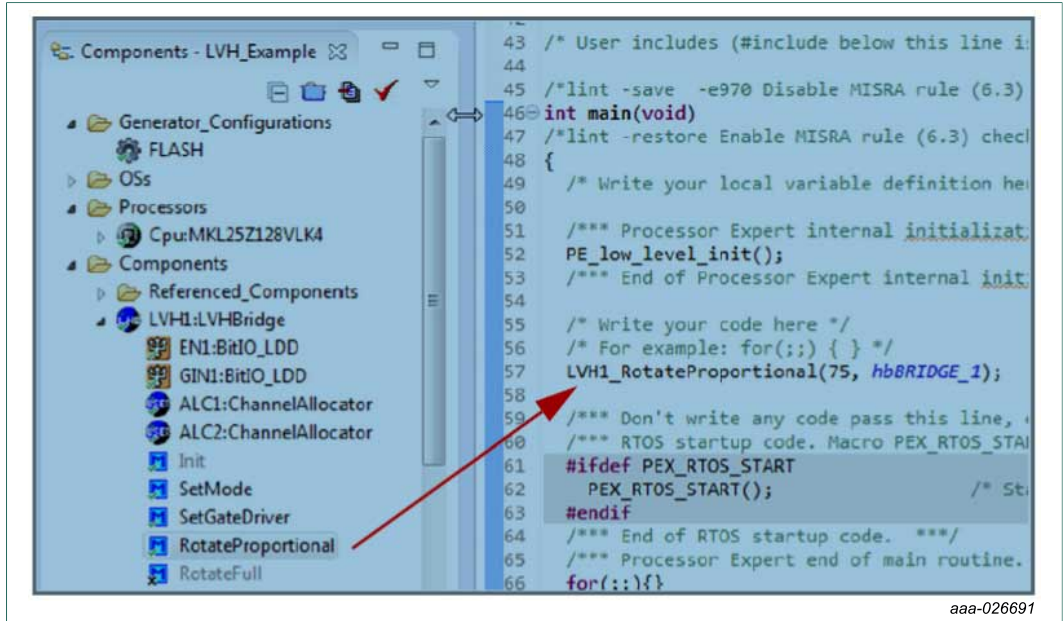

Figure 18. Using the interface

To compile, download and debug on board, click compile, and then click the debug icon in the toolbar. CodeWarrior downloads and launches the program on board as shown in Figure 19.

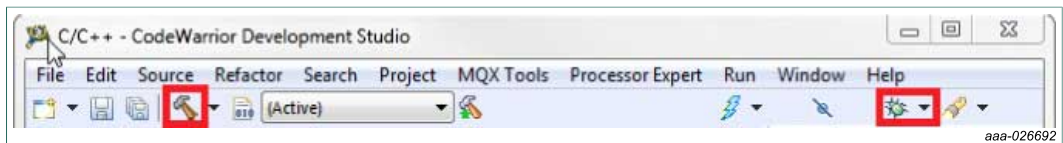

Figure 19. Compile and download the application

A description of each LVHBridge method appears in the pop-up window.

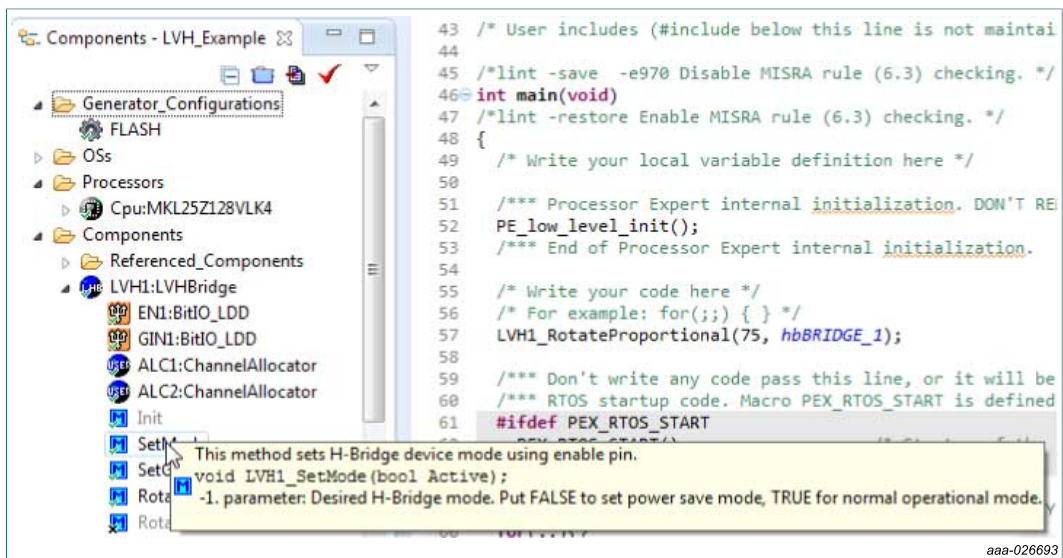

Figure 20. LVHBridge method information

## 6.6 Stepper motor control application notes

The LVHBridge component is designed to control a two phase bipolar stepper motor. Because a stepper motor uses electrical commutation to rotate, it requires a dual H-bridge device. The basic control method is full-stepping which fully powers each coil in sequence. Increased precision is achieved by using the PWM to control coil current (open loop control). This method is called micro-stepping (available in the LVHBridge component.)

In both micro-step and full-step mode you can control motor speed, direction, acceleration and deceleration and the position of the stepper motor.

The following application notes apply to stepper motor control:

- The LVHBridge component was tested with a core clock frequency ranging from 20 MHz (minimum value) to 120 MHz.
- Do not change the settings of the timer device (TimerUnit\_LDD) linked by the LVHBridge component. The component sets the timer device automatically.
- The acceleration and deceleration ramp of the stepper motor is computed in real-time using integer arithmetic. This solution is based on the article "Generate stepper-motor speed profiles in real time" (Austin, David. 2005.)
- The stepper motor holds its position (coils are powered) after motor movement is completed. Use method DisableMotor to set H-bridge outputs to LOW (coils are not powered).
- Forward motor direction indicates that steps are executed in the order depicted in [Figure 21](#). IN1 through IN4 are the input pins of the H-bridge device which control H-bridge outputs. These pins input to the stepper motor. You must connect the stepper motor to output pins OUT1-OUT4 and select control input pins on your MCU in the component settings.
- The FTM or TPM timer device is needed by the stepper control logic.
- The AlignRotor method affects the position of the motor. This method executes four full-steps. It is available only when full-step mode is enabled.

### 6.6.1 Full-step control mode

The component uses normal drive mode where two coils are powered at the same time.

As mentioned in [Section 6.5.4 "Setting up a project to control a stepper motor"](#), you can generate a full-stepping signal either by using four channels of a timer or by using four GPIO pins. The signal generated by the MCU (inputs of H-bridge device) using four timer channels is shown in [Figure 21](#). The voltage levels applied to the coils of the stepper motor are depicted in [Figure 22](#). Note that the voltage is applied to both coils at the same time.

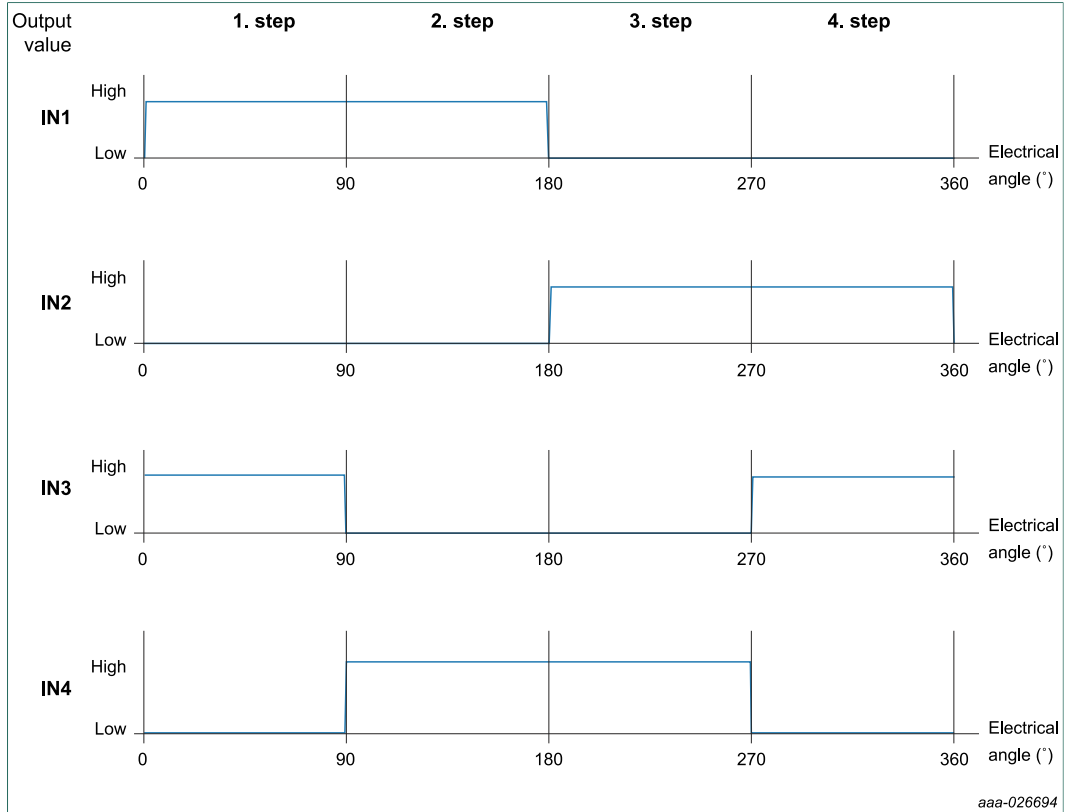

Figure 21. Signals of logic input pins generated by the MCU in full-step mode

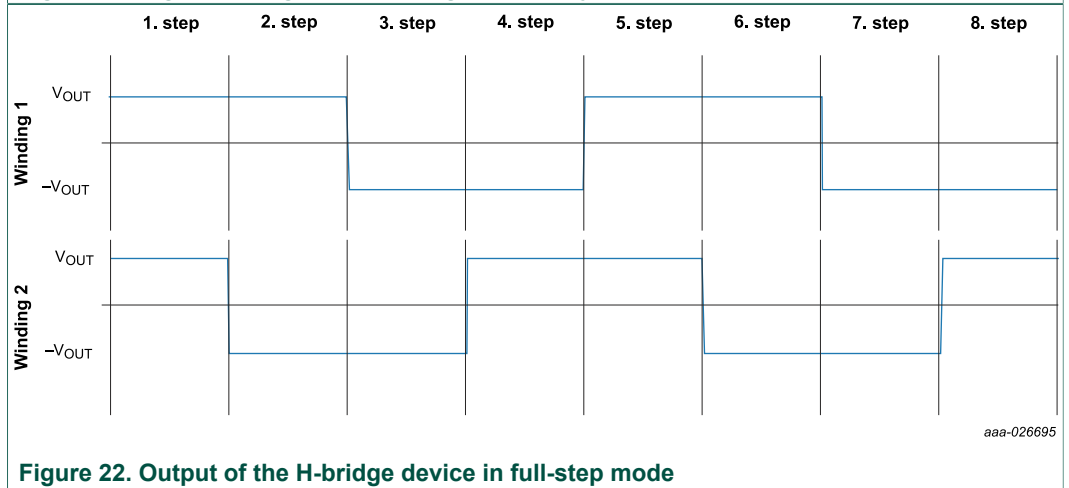

Figure 22. Output of the H-bridge device in full-step mode

### 6.6.2 Micro-step control mode

Micro-stepping allows for smoother motor movement and increased precision. The current varies in motor windings A and B depending on the micro-step position. A PWM signal is used to reach the desired current value (see the following equations). This method is called sine cosine micro-stepping.

$$I_A = I_{MAX} \times \sin(\theta)$$

$$I_B = I_{MAX} \times \cos(\theta)$$



where:

$I_A$  = the current in winding A

$I_B$  = the current in winding B

$I_{MAX}$  = the maximum allowable current

$\theta$  = the electrical angle

In micro-step mode, a full-step is divided into smaller steps (micro-steps). The LVHBridge component offers 2, 4, 8, 16 and 32 micro-steps per full-step. The micro-step size is defined by the property "Micro-steps per Step" and can be changed later in C code.

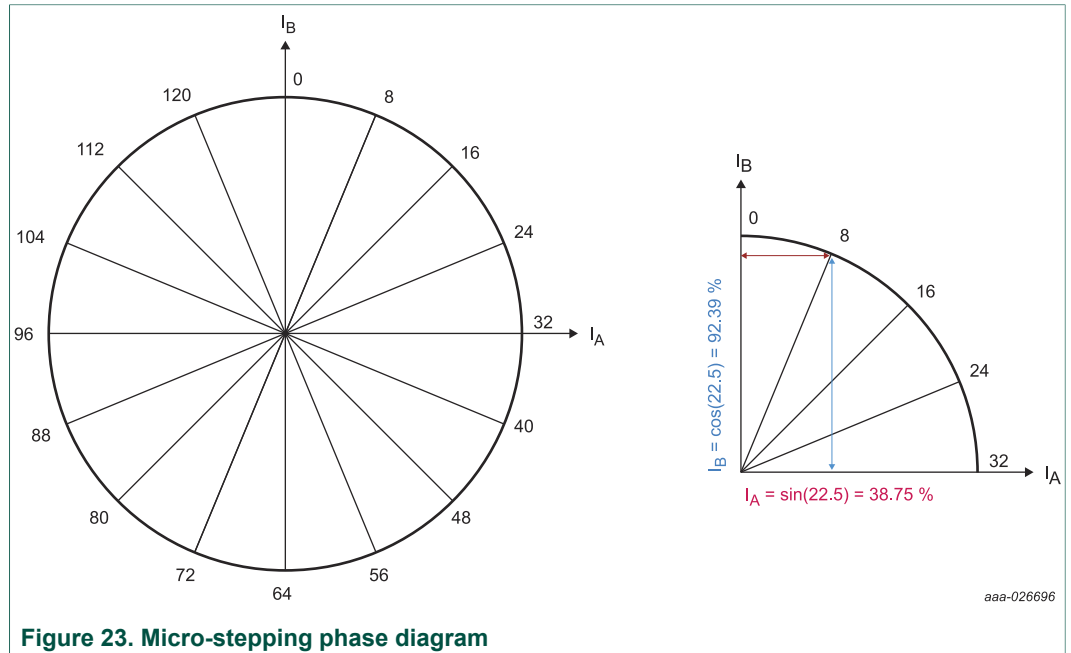

**Figure 23. Micro-stepping phase diagram**

**Table 12. Micro-step phase**

| Micro-step size <sup>[1]</sup> |     |     |      |      | Angle | I [% of I <sub>MAX</sub> ] |       | Micro-step size |     |     |      |      | Angle | I [% of I <sub>MAX</sub> ] |        |
|--------------------------------|-----|-----|------|------|-------|----------------------------|-------|-----------------|-----|-----|------|------|-------|----------------------------|--------|
| 1/2                            | 1/4 | 1/8 | 1/16 | 1/32 |       | A                          | B     | 1/2             | 1/4 | 1/8 | 1/16 | 1/32 |       | A                          | B      |
| 0                              | 0   | 0   | 0    | 0    | 0.0   | 0                          | 100   | 4               | 8   | 16  | 32   | 64   | 180   | 0                          | -100   |
|                                |     |     |      | 1    | 2.8   | 4.91                       | 99.88 |                 |     |     |      | 65   | 182.8 | -4.91                      | -99.88 |
|                                |     |     | 1    | 2    | 5.6   | 9.8                        | 99.52 |                 |     |     | 33   | 66   | 185.6 | -9.8                       | -99.52 |
|                                |     |     |      | 3    | 8.4   | 14.67                      | 98.92 |                 |     |     |      | 67   | 188.4 | -14.67                     | -98.92 |
|                                |     | 1   | 2    | 4    | 11.3  | 19.51                      | 98.08 |                 |     | 17  | 34   | 68   | 191.3 | -19.51                     | -98.08 |
|                                |     |     |      | 5    | 14.1  | 24.3                       | 97    |                 |     |     |      | 69   | 194.1 | -24.3                      | -97    |
|                                |     |     | 3    | 6    | 16.9  | 29.03                      | 95.69 |                 |     |     | 35   | 70   | 196.9 | -29.03                     | -95.69 |
|                                |     |     |      | 7    | 19.7  | 33.69                      | 94.15 |                 |     |     |      | 71   | 199.7 | -33.69                     | -94.15 |
|                                | 1   | 2   | 4    | 8    | 22.5  | 38.27                      | 92.39 |                 | 9   | 18  | 36   | 72   | 202.5 | -38.27                     | -92.39 |
|                                |     |     |      | 9    | 25.3  | 42.76                      | 90.4  |                 |     |     |      | 73   | 205.3 | -42.76                     | -90.4  |
|                                |     |     | 5    | 10   | 28.1  | 47.14                      | 88.19 |                 |     |     |      | 74   | 208.1 | -47.14                     | -88.19 |
|                                |     |     |      | 11   | 30.9  | 51.41                      | 85.77 |                 |     |     |      | 75   | 210.9 | -51.41                     | -85.77 |
|                                |     | 3   | 6    | 12   | 33.8  | 55.56                      | 83.15 |                 |     | 19  | 38   | 76   | 213.8 | -55.56                     | -83.15 |
|                                |     |     |      | 13   | 36.6  | 59.57                      | 80.32 |                 |     |     |      | 77   | 216.6 | -59.57                     | -80.32 |
|                                |     |     | 7    | 14   | 39.4  | 63.44                      | 77.3  |                 |     |     | 39   | 78   | 219.4 | -63.44                     | -77.3  |
|                                |     |     |      | 15   | 42.2  | 67.16                      | 74.1  |                 |     |     |      | 79   | 222.2 | -67.16                     | -74.1  |
| 1                              | 2   | 4   | 8    | 16   | 45    | 70.71                      | 70.71 | 5               | 10  | 20  | 40   | 80   | 225   | -70.71                     | -70.71 |
|                                |     |     |      | 17   | 47.8  | 74.1                       | 67.16 |                 |     |     |      | 81   | 227.8 | -74.1                      | -67.16 |

| Micro-step size <sup>[1]</sup> |     |     |      |      | Angle | I [% of I <sub>MAX</sub> ] |        | Micro-step size |     |     |      |      | Angle | I [% of I <sub>MAX</sub> ] |        |        |
|--------------------------------|-----|-----|------|------|-------|----------------------------|--------|-----------------|-----|-----|------|------|-------|----------------------------|--------|--------|
| 1/2                            | 1/4 | 1/8 | 1/16 | 1/32 |       | A                          | B      | 1/2             | 1/4 | 1/8 | 1/16 | 1/32 |       | A                          | B      |        |
|                                |     |     | 9    | 18   | 50.6  | 77.3                       | 63.44  |                 |     |     | 41   | 82   | 230.6 | -77.3                      | -63.44 |        |
|                                |     |     |      | 19   | 53.4  | 80.32                      | 59.57  |                 |     |     |      | 83   | 233.4 | -80.32                     | -59.57 |        |
|                                |     | 5   | 10   | 20   | 56.3  | 83.15                      | 55.56  |                 |     | 21  | 42   | 84   | 236.3 | -83.15                     | -55.56 |        |
|                                |     |     |      | 21   | 59.1  | 85.77                      | 51.41  |                 |     |     |      | 85   | 239.1 | -85.77                     | -51.41 |        |
|                                |     |     |      | 11   | 61.9  | 88.19                      | 47.14  |                 |     |     |      | 43   | 86    | 241.9                      | -88.19 | -47.14 |
|                                |     |     |      | 23   | 64.7  | 90.4                       | 42.76  |                 |     |     |      | 87   | 244.7 | -90.4                      | -42.76 |        |
|                                | 3   | 6   | 12   | 24   | 67.5  | 92.39                      | 38.27  |                 |     | 11  | 22   | 44   | 88    | 247.5                      | -92.39 | -38.27 |
|                                |     |     |      | 25   | 70.3  | 94.15                      | 33.69  |                 |     |     |      | 89   | 250.3 | -94.15                     | -33.69 |        |
|                                |     |     |      | 13   | 73.1  | 95.69                      | 29.03  |                 |     |     |      | 45   | 90    | 253.1                      | -95.69 | -29.03 |
|                                |     |     |      | 27   | 75.9  | 97                         | 24.3   |                 |     |     |      | 91   | 255.9 | -97                        | -24.3  |        |
|                                |     | 7   | 14   | 28   | 78.8  | 98.08                      | 19.51  |                 |     | 23  | 46   | 92   | 258.8 | -98.08                     | -19.51 |        |
|                                |     |     |      | 29   | 81.6  | 98.92                      | 14.67  |                 |     |     |      | 93   | 261.6 | -98.92                     | -14.67 |        |
|                                |     |     |      | 15   | 84.4  | 99.52                      | 9.8    |                 |     |     |      | 47   | 94    | 264.4                      | -99.52 | -9.8   |
|                                |     |     |      | 31   | 86.4  | 99.8                       | 6.3    |                 |     |     |      | 95   | 266.4 | -99.8                      | -6.3   |        |
| 2                              | 4   | 8   | 16   | 32   | 90    | 100                        | 0.00   | 6               | 12  | 24  | 48   | 96   | 270   | -100                       | 0.00   |        |
|                                |     |     |      | 33   | 92.8  | 99.88                      | -4.91  |                 |     |     |      | 97   | 272.8 | -99.88                     | 4.91   |        |
|                                |     |     |      | 17   | 34    | 95.6                       | -9.8   |                 |     |     |      | 49   | 98    | 275.6                      | -99.52 | 9.8    |
|                                |     |     |      | 35   | 98.4  | 98.92                      | -14.67 |                 |     |     |      | 99   | 278.4 | -98.92                     | 14.67  |        |
|                                |     | 9   | 18   | 36   | 101.3 | 98.08                      | -19.51 |                 |     | 25  | 50   | 100  | 281.3 | -98.08                     | 19.51  |        |
|                                |     |     |      | 37   | 104.1 | 97                         | -24.3  |                 |     |     |      | 101  | 284.1 | -97                        | 24.3   |        |
|                                |     |     |      | 19   | 38    | 106.9                      | -29.03 |                 |     |     |      | 51   | 102   | 286.9                      | -95.69 | 29.03  |
|                                |     |     |      | 39   | 109.7 | 94.15                      | -33.69 |                 |     |     |      | 103  | 289.7 | -94.15                     | 33.69  |        |
|                                | 5   | 10  | 20   | 40   | 112.5 | 92.39                      | -38.27 |                 |     | 13  | 26   | 52   | 104   | 292.5                      | -92.39 | 38.27  |
|                                |     |     |      | 41   | 115.3 | 90.4                       | -42.76 |                 |     |     |      | 105  | 295.3 | -90.4                      | 42.76  |        |
|                                |     |     |      | 21   | 42    | 118.1                      | -47.14 |                 |     |     |      | 53   | 106   | 298.1                      | -88.19 | 47.14  |
|                                |     |     |      | 43   | 120.9 | 85.77                      | -51.41 |                 |     |     |      | 107  | 300.9 | -85.77                     | 51.41  |        |
|                                |     | 11  | 22   | 44   | 123.8 | 83.15                      | -55.56 |                 |     | 27  | 54   | 108  | 303.8 | -83.15                     | 55.56  |        |
|                                |     |     |      | 45   | 126.6 | 80.32                      | -59.57 |                 |     |     |      | 109  | 306.6 | -80.32                     | 59.57  |        |
|                                |     |     |      | 23   | 46    | 129.4                      | -63.44 |                 |     |     |      | 55   | 110   | 309.4                      | -77.3  | 63.44  |
|                                |     |     |      | 47   | 132.2 | 74.1                       | -67.16 |                 |     |     |      | 111  | 312.2 | -74.1                      | 67.16  |        |
| 3                              | 6   | 12  | 24   | 48   | 135   | 70.71                      | -70.71 | 7               | 14  | 28  | 56   | 112  | 315   | -70.71                     | 70.71  |        |
|                                |     |     |      | 49   | 137.8 | 67.16                      | -74.1  |                 |     |     |      | 113  | 317.8 | -67.16                     | 74.1   |        |
|                                |     |     |      | 25   | 50    | 140.6                      | -77.3  |                 |     |     |      | 57   | 114   | 320.6                      | -63.44 | 77.3   |
|                                |     |     |      | 51   | 143.4 | 59.57                      | -80.32 |                 |     |     |      | 115  | 323.4 | -59.57                     | 80.32  |        |
|                                |     | 13  | 26   | 52   | 146.3 | 55.56                      | -83.15 |                 |     | 29  | 58   | 116  | 326.3 | -55.56                     | 83.15  |        |
|                                |     |     |      | 53   | 149.1 | 51.41                      | -85.77 |                 |     |     |      | 117  | 329.1 | -51.41                     | 85.77  |        |
|                                |     |     |      | 27   | 54    | 151.9                      | -88.19 |                 |     |     |      | 59   | 118   | 331.9                      | -47.14 | 88.19  |
|                                |     |     |      | 55   | 154.7 | 42.76                      | -90.4  |                 |     |     |      | 119  | 334.7 | -42.76                     | 90.4   |        |
|                                | 7   | 14  | 28   | 56   | 157.5 | 38.27                      | -92.39 |                 |     | 15  | 30   | 60   | 120   | 337.5                      | -38.27 | 92.39  |
|                                |     |     |      | 57   | 160.3 | 33.69                      | -94.15 |                 |     |     |      | 121  | 340.3 | -33.69                     | 94.15  |        |
|                                |     |     |      | 29   | 58    | 163.1                      | -95.69 |                 |     |     |      | 61   | 122   | 343.1                      | -29.03 | 95.69  |
|                                |     |     |      | 59   | 165.9 | 24.3                       | -97    |                 |     |     |      | 123  | 345.9 | -24.3                      | 97     |        |
|                                |     | 15  | 30   | 60   | 168.8 | 19.51                      | -98.08 |                 |     | 31  | 62   | 124  | 348.8 | -19.51                     | 98.08  |        |
|                                |     |     |      | 61   | 171.6 | 14.67                      | -98.92 |                 |     |     |      | 125  | 351.6 | -14.67                     | 98.92  |        |
|                                |     |     |      | 31   | 62    | 174.4                      | 9.8    | -99.52          |     |     |      | 63   | 126   | 354.4                      | -9.8   | 99.52  |
|                                |     |     |      | 63   | 176.4 | 6.3                        | -99.8  |                 |     |     |      | 127  | 356.4 | -6.3                       | 99.8   |        |
| 4                              | 8   | 16  | 32   | 64   | 180   | 0.00                       | -100   | 8               | 16  | 32  | 64   | 128  | 360   | 0.00                       | 100    |        |

[1] Shaded rows indicate one quarter step of the motor

The micro-stepping signal is generated using four timer channels (see [Figure 24](#)). Output from logic analyzer in [Figure 25](#) shows the change of PWM duty with respect to the

micro-step position. Current values applied to the stepper motor coils are depicted in [Figure 26](#).

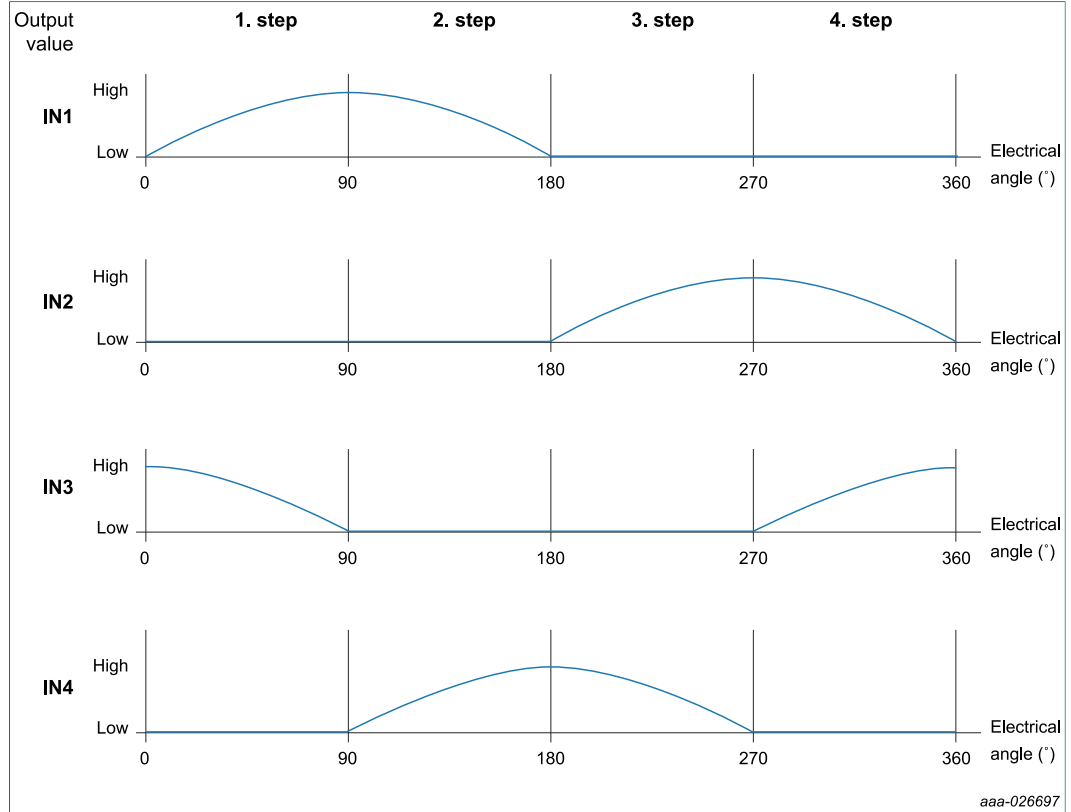

**Figure 24. Logic input pin signals generated by the MCU in micro-step mode**

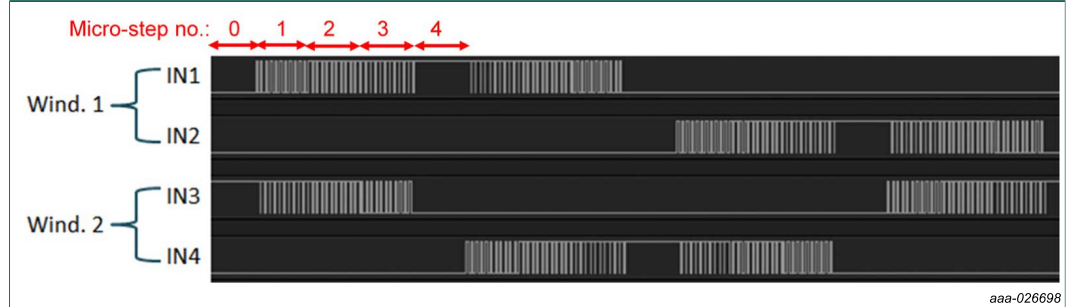

**Figure 25. Logic Analyzer output**

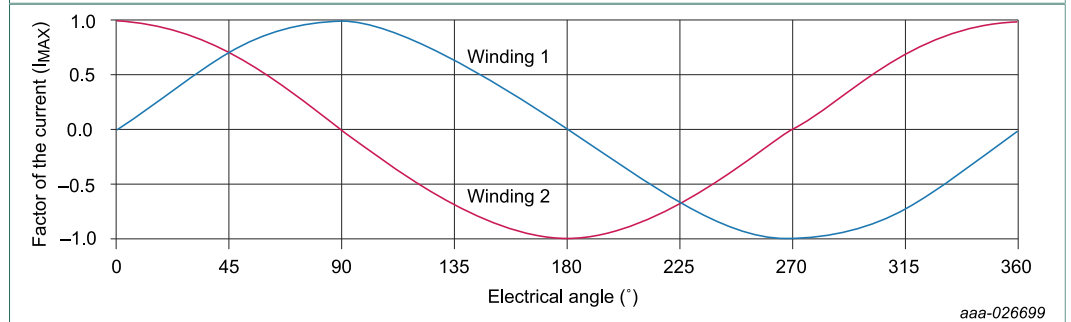

**Figure 26. H-bridge device output in micro-step mode**

### 6.7 Frequently asked questions

**Q:** How do I set up the LVHBridge component when two or more components with conflicting values are configured to control brushed motors?

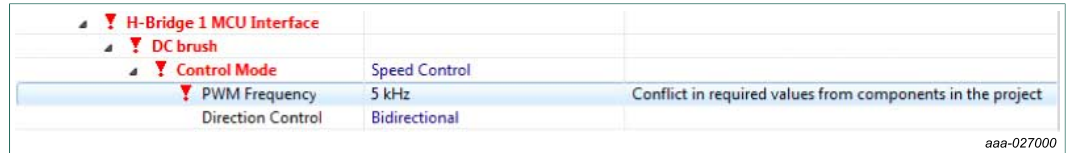
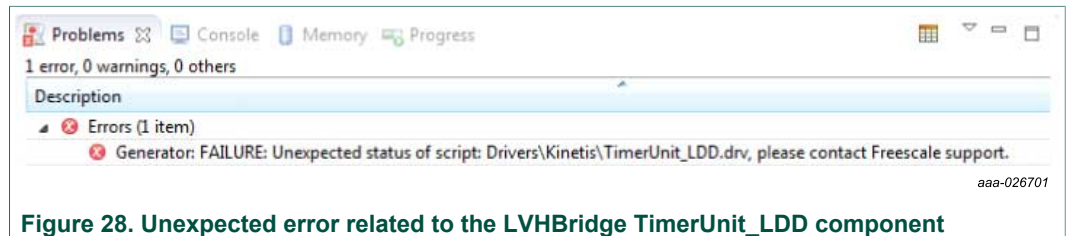

**Figure 27. Conflict in the required values for components in the project**

**A:** You can use more LVHBridge components in same project. These components can share the same timer device in brushed motor control mode, but PWM Frequency and Timer Device properties must conform in all of the components.

**Q:** I sometimes get the following unexpected error while generating Processor Expert code: "Generator: FAILURE: Unexpected status of script: Drivers\Kinetis\TimerUnit\_LDD.drv, please contact NXP support". What causes this?

**A:** Occasionally, when you enable the LVHBridge component in your project, the TimerUnit\_LDD component channels have not been allocated. If this occurs, changing certain LVHBridge properties force allocation of the channels. If you are configuring a stepper motor (Motor Control property set to Stepper), try changing the Output Control property to GPIO and then back to PWM. If you are configuring a brushed motor (Motor Control property set to Brushed), change the Control Mode property to State Control and then back to Speed Control on interface 1 or interface 2.



**Figure 28. Unexpected error related to the LVHBridge TimerUnit\_LDD component**

**Q:** I have set up several CPU clock configurations (via the Clock configurations property of the CPU component.) Sometimes during runtime, when I switch between these configurations (using the CPU SetClockConfiguration method), the speed of the stepper motor appears to be inaccurate. Why does this occur?

**A:** Switching to a different configuration results in the use of a different input frequency by a timer device. LVHBridge may not pick up the new value and continues to use the previous value in its calculations.

**Q:** What does the error message "The component has no method to enable its event (OnCounterRestart)" raised in an LVHBridge TimerUnit\_LDD component mean?

**A:** This occurs only when you add an LVHBridge component to a project and set the Motor Control property to Stepper. The error disappears if you change any property of the LVHBridge component.

## 7 Schematics, board layout and bill of materials

Board schematics, board layout and bill of materials are available in the download tab of the tool summary page. See [Section 8 "References"](#) for link to the relevant tool summary page.

## 8 References

The following URLs reference related NXP products and application solutions:

**Table 13. References**

| NXP.com support pages       | Description            | URL  |
|-----------------------------|------------------------|--|
| FRDM-34933EVB               | Tool summary page      | <a href="http://www.nxp.com/FRDM-34933EVB">www.nxp.com/FRDM-34933EVB</a>   |
| FRDM-KL25Z                  | Tool summary page      | <a href="http://www.nxp.com/FRDM-KL25Z">http://www.nxp.com/FRDM-KL25Z</a>  |
| LVHBRIDGE-PEXPRT            | Software               | <a href="http://www.nxp.com/LVHBRIDGE-PEXPRT">http://www.nxp.com/LVHBRIDGE-PEXPRT</a>  |
| CodeWarrior                 | Tool summary page      | <a href="http://www.nxp.com/CODEWARRIOR">http://www.nxp.com/CODEWARRIOR</a>  |
| Processor Expert Code Model | Code Walkthrough Video | <a href="http://www.nxp.com/video/processor-expert-code-model-codewarrior-code-walkthrough:PROEXPCODMODCW_VID">www.nxp.com/video/processor-expert-code-model-codewarrior-code-walkthrough:PROEXPCODMODCW_VID</a> |
| MC34933                     | Product summary page   | <a href="http://www.nxp.com/MC34933">http://www.nxp.com/MC34933</a>  |
| mbed                        | Home page              | <a href="http://www.mbed.com">http://www.mbed.com</a>  |

## 9 Contact information

Visit <http://www.nxp.com/support> for a list of phone numbers within your region.

Visit <http://www.nxp.com/warranty> to submit a request for tool warranty.

## Revision history

**Revision history**

| Revision number | Date       | Description                     |
|-----------------|------------|---------------------------------|
| 1.0             | 2017-03-15 | Initial version of the document |

## 10 Legal information

### 10.1 Definitions

**Draft** — The document is a draft version only. The content is still under internal review and subject to formal approval, which may result in modifications or additions. NXP Semiconductors does not give any representations or warranties as to the accuracy or completeness of information included herein and shall have no liability for the consequences of use of such information.

### 10.2 Disclaimers

Information in this document is provided solely to enable system and software implementers to use NXP products. There are no express or implied copyright licenses granted hereunder to design or fabricate any integrated circuits based on the information in this document. NXP reserves the right to make changes without further notice to any products herein.

NXP makes no warranty, representation, or guarantee regarding the suitability of its products for any particular purpose, nor does NXP assume any liability arising out of the application or use of any product or circuit,

and specifically disclaims any and all liability, including without limitation consequential or incidental damages. "Typical" parameters that may be provided in NXP data sheets and/or specifications can and do vary in different applications, and actual performance may vary over time. All operating parameters, including "typicals," must be validated for each customer application by customer's technical experts. NXP does not convey any license under its patent rights nor the rights of others. NXP sells products pursuant to standard terms and conditions of sale, which can be found at the following address: [nxp.com/salestermsandconditions](http://nxp.com/salestermsandconditions).

### 10.3 Trademarks

Notice: All referenced brands, product names, service names and trademarks are the property of their respective owners.

**NXP** — is a trademark of NXP B.V.

**the NXP logo** — is a trademark of NXP B.V.

**Freescale** — is a trademark of NXP B.V.

**the Freescale logo** — is a trademark of NXP B.V.

**SMARTMOS** — is a trademark of NXP B.V.