



## Start-up Guide

# BACnet IoT Gateway FS-IOT-BACX

### APPLICABILITY & EFFECTIVITY

Effective for all systems manufactured after April 2022.



Document Revision: 6.E

T18620



**fieldserver**

MSA Safety  
1991 Tarob Court  
Milpitas, CA 95035  
Website: [www.MSAsafety.com](http://www.MSAsafety.com)

U.S. Support Information:  
+1 408 964-4443  
+1 800 727-4377  
Email: [smc-support@msasafety.com](mailto:smc-support@msasafety.com)

EMEA Support Information:  
+31 33 808 0590  
Email: [smc-support.emea@msasafety.com](mailto:smc-support.emea@msasafety.com)

## Table of Contents

<b>1</b>	<b>BACnet IoT Gateway Description .....</b>	<b>7</b>
<b>2</b>	<b>Equipment Setup .....</b>	<b>8</b>
2.1	Physical Dimensions .....	8
2.1.1	FS-IOT-BAC Drawing.....	8
2.1.2	FS-IOT-BAC2E Drawing .....	9
2.1.3	FS-IOT-BACW Drawing .....	10
2.1.4	FS-IOT-BACA/V/F Drawing.....	11
2.2	Mounting .....	12
2.3	Attaching the Antenna(s) .....	12
2.4	FS-IOT-BACA/V/F: Inserting the SIM Card .....	13
<b>3</b>	<b>Installing the BACnet IoT Gateway.....</b>	<b>15</b>
3.1	FS-IOT- BAC/BACW/BAC2E: Connecting the R1 & R2 Ports .....	15
3.1.1	Wiring .....	15
3.2	FS-IOT-BACA/V/F: Connecting the P1 Port.....	16
3.2.1	Wiring .....	16
3.3	10/100 Ethernet Connection Port .....	17
<b>4</b>	<b>Power up the BACnet IoT Gateway .....</b>	<b>18</b>
<b>5</b>	<b>Connecting to the BACnet IoT Gateway .....</b>	<b>19</b>
5.1	Using the FieldServer Toolbox .....	19
5.2	Using a Web Browser .....	19
<b>6</b>	<b>Setup Web Server Security .....</b>	<b>20</b>
6.1	Login to the FieldServer .....	20
6.2	Select the Security Mode.....	22
6.2.1	HTTPS with Own Trusted TLS Certificate .....	23
6.2.2	HTTPS with Default Untrusted Self-Signed TLS Certificate or HTTP with Built-in Payload Encryption .....	23
<b>7</b>	<b>Gateway Settings .....</b>	<b>24</b>
7.1	Navigate to the Settings .....	24
7.1.1	ETH 1 IP Settings.....	25
7.1.2	Wi-Fi Client.....	26
7.1.3	Wi-Fi Access Point .....	27
7.1.4	Routing.....	28
7.1.5	FS-IOT-BACA/V/F: Cellular LTE .....	29
7.1.6	FS-IOT-BAC2E: Ethernet 2 Network Settings – LAN Mode .....	30
7.1.7	FS-IOT-BAC2E: Ethernet 2 Network Settings – WAN Mode .....	31
7.2	Local Settings – BACnet.....	32
7.3	Remote Settings – Foreign Device Registration for BBMD Support .....	33
<b>8</b>	<b>Using the BACnet IoT Gateway .....</b>	<b>34</b>
8.1	BACnet Explorer .....	34
8.1.1	Discover the Device List.....	35
8.1.2	View Device Details and Explore Points/Parameters .....	36
8.1.3	Explore All of a Device's Points – Deep Explore .....	38
8.1.4	Checking Device Information – Device Info .....	39
8.1.5	Edit the Present Value Field.....	40
8.2	Monitor View .....	42
8.2.1	Set Devices to Track .....	42
8.2.2	Logging Data .....	43
8.3	Data Log Viewer .....	45
8.3.1	Graph Data Logging Information.....	45
8.3.2	Creating an Event Log .....	48
8.4	Event Log.....	50

<b>9</b>	<b>FieldServer Manager Setup</b> .....	<b>51</b>
9.1	Create a New FieldServer Manager Account.....	51
9.2	Login to the FieldServer Manager.....	58
<b>10</b>	<b>MQTT Integration</b> .....	<b>60</b>
10.1	MQTT Published Messages.....	60
10.2	Connect to MQTT.....	61
10.3	Check the Status Window.....	62
<b>11</b>	<b>OpenVPN Setup</b> .....	<b>63</b>
11.1	Setup Amazon AWS Server.....	63
11.2	Setup OpenVPN Cloud.....	64
11.2.1	Configure the OpenVPN Server.....	64
11.2.2	Login to the Server.....	64
11.2.3	Create a New User for the PC Connection.....	65
11.2.4	Create a New User for the Device Connection.....	67
11.3	Configure BACnet IoT Gateway for OpenVPN.....	69
11.3.1	Download the DEVIC Configuration Profile.....	69
11.3.2	Load the DEVICE OpenVPN Connection Profile onto the BACnet IoT Gateway.....	70
11.4	Install the OpenVPN Client onto a Local PC.....	71
11.4.1	Download the USER Configuration Profile.....	71
11.4.2	Load the USER OpenVPN Connection Profile onto the PC.....	72
<b>12</b>	<b>Specifications</b> .....	<b>73</b>
<b>13</b>	<b>References</b> .....	<b>74</b>
13.1	Understanding FDR.....	74
13.2	Understanding BACnet BBMD and NAT Routing.....	74
<b>14</b>	<b>Troubleshooting</b> .....	<b>76</b>
14.1	Communicating with the BACnet IoT Gateway Over the Network.....	76
14.2	Lost or Incorrect IP Address.....	77
14.3	Viewing Diagnostic Information.....	78
14.4	Checking Wiring and Settings.....	78
14.5	LED Diagnostics for Communications Between BACnet IoT Gateway and Devices.....	79
14.6	Taking a FieldServer Diagnostic Capture.....	80
14.7	Kaspersky Endpoint Security 10.....	81
14.8	Wi-Fi and Cellular Signal Strength.....	82
14.9	Factory Reset Instructions.....	82
14.10	Internet Browser Software Support.....	82
14.11	APN Table.....	82
14.12	Two Ethernet Port IP Subnets.....	83
14.13	Data Missing on RESTful API and/or the Grid.....	83
<b>15</b>	<b>Additional Information</b> .....	<b>84</b>
15.1	Updating Firmware.....	84
15.2	Change Web Server Security Settings After Initial Setup.....	85
15.2.1	Change Security Mode.....	86
15.2.2	Edit the Certificate Loaded onto the FieldServer.....	87
15.3	Change User Management Settings.....	88
15.3.1	Create Users.....	89
15.3.2	Edit Users.....	90
15.3.3	Delete Users.....	91
15.3.4	Change FieldServer Password.....	92
15.4	System Status Button.....	93
<b>16</b>	<b>Limited 2 Year Warranty</b> .....	<b>94</b>

## List of Figures

Figure 1: BACnet IoT Gateway FS-IOT-BAC Dimensions.....	8
Figure 2: BACnet IoT Gateway FS-IOT-BAC2E Dimensions .....	9
Figure 3: BACnet IoT Gateway FS-IOT-BACW Dimensions .....	10
Figure 4: BACnet IoT Gateway FS-IOT-BAC/V/F Dimensions .....	11
Figure 5: DIN Rail.....	12
Figure 6: Insert SIM Card into the Micro SIM Card Slot – Label Side View (Left) and Top Down View (Right).....	13
Figure 7: Cellular Data Usage Examples .....	14
Figure 8: R1 & R2 Connection Ports.....	15
Figure 9: RS-485 P1 Connection Port .....	16
Figure 10: Ethernet Connection .....	17
Figure 11: Required Current Draw for the BACnet IoT Gateway.....	18
Figure 12: Connecting Power for FS-IOT- BAC/BACW/BAC2E .....	18
Figure 13: Connecting Power for FS-IOT-BACA/V/F.....	18
Figure 14: Web Server Security Window .....	20
Figure 15: Connection Not Private Warning .....	20
Figure 16: Warning Expanded Text .....	21
Figure 17: FieldServer Login.....	21
Figure 18: Security Mode Selection Screen.....	22
Figure 19: Security Mode Selection Screen – Certificate & Private Key .....	23
Figure 20: Web App Landing Page.....	24
Figure 21: Settings Tabs .....	24
Figure 22: Opt Out Warning Message .....	24
Figure 23: Configuration Button Functions .....	25
Figure 24: ETH 1 Port Network Settings .....	25
Figure 25: Wi-Fi Client Network Settings .....	26
Figure 26: Wi-Fi AP Network Settings .....	27
Figure 27: Routing Network Settings .....	28
Figure 28: Cellular Network Settings .....	29
Figure 29: Ethernet 2 Port Network Settings .....	30
Figure 30: Ethernet 2 Port Firewall Settings .....	31
Figure 31: Connection Settings.....	32
Figure 32: Connection Parameters .....	32
Figure 33: FDR Enabled Checkbox .....	33
Figure 34: FDR IP Fields.....	33
Figure 35: BACnet Explorer Page.....	34
Figure 36: Discovery Window .....	35
Figure 37: Device List .....	35
Figure 38: Device Sub-items.....	36
Figure 39: Full Device Sub-items .....	36
Figure 40: Simplified Device Details .....	37
Figure 41: Additional Device Details .....	37
Figure 42: Highlighted Present Value .....	40
Figure 43: Write Property Window .....	40
Figure 44: Updated Present Value.....	41
Figure 45: Selected Device Properties for Monitor View .....	42
Figure 46: Highlighted Monitor View Tab.....	42
Figure 47: Monitor View Showing Tracked Device Properties.....	43
Figure 48: Data Logging Window.....	43
Figure 49: Change of Value Log Type .....	43
Figure 50: Periodic Log Type .....	43
Figure 51: Settings Window .....	44
Figure 52: Edit Poll Interval Window .....	44

Figure 53: Data Log Viewer Page .....	45
Figure 54: Data Log Viewer Settings Window .....	45
Figure 55: Confirm Clear Logs Window .....	46
Figure 56: Data Log Viewer Graph .....	46
Figure 57: Selected Portion of Data Log Viewer Graph.....	47
Figure 58: Monitor View Device Properties.....	48
Figure 59: Event Settings Window .....	48
Figure 60: Add Event Settings .....	48
Figure 61: Event Settings Window with Added Events.....	49
Figure 62: Monitor View Device Properties with Updated Status .....	49
Figure 63: Event Log Page Showing Added Events.....	50
Figure 64: BACnet IoT Gateway Landing Page – FieldServer Manager Tab.....	51
Figure 65: Registration Information Page .....	51
Figure 66: FieldServer Manager Connection Problems Message .....	52
Figure 67: FieldServer Manager Registration – Installer Details .....	53
Figure 68: FieldServer Manager Registration – Site Details.....	53
Figure 69: FieldServer Manager Registration – Gateway Details .....	54
Figure 70: FieldServer Manager Registration – Account.....	54
Figure 71: Device Registered for the FieldServer Manager .....	55
Figure 72: Welcome to FieldServer Manager Email .....	56
Figure 73: Setting User Details .....	57
Figure 74: FieldServer Manager Login Page .....	58
Figure 75: FieldServer Manager Landing Page .....	59
Figure 76: Specifications.....	73
Figure 77: BBMD Scenario 1 – Interconnected IP Network.....	74
Figure 78: BBMD Scenario 2 – NAT Routing.....	75
Figure 79: Ethernet Port Location .....	77
Figure 80: Error Messages Screen .....	78
Figure 81: Diagnostic LEDs .....	79
Figure 82: Kaspersky ES10 Settings .....	81
Figure 83: Web Anti-Virus Trusted URLs.....	81
Figure 84: Wi-Fi & Cellular Signal Strength Listing.....	82
Figure 85: Cellular Provider APN .....	82
Figure 86: FS-GUI Page .....	85
Figure 87: FS-GUI Security Setup .....	86
Figure 88: FS-GUI Security Setup – Certificate Loaded.....	87
Figure 89: FS-GUI User Management.....	88
Figure 90: Create User Window.....	89
Figure 91: Setup Users .....	90
Figure 92: Edit User Window .....	90
Figure 93: Setup Users .....	91
Figure 94: User Delete Warning .....	91
Figure 95: FieldServer Password Update via FS-GUI .....	92

### 1 BACnet IoT Gateway Description

The BACnet IoT Gateway provides a connection from BACnet devices and networks to the cloud. This is achieved via a discovery tool built into the hardware for any BACnet/IP or BACnet MS/TP network without any additional dongles or installations needed. BBMD BACnet network discovery is also supported.

The BACnet IoT Gateway comes in four model types. The FS-IOT-BAC model offers two RS-485 ports and one Ethernet 10/100 port. The FS-IOT-BAC2E model offers two RS-485 ports and two Ethernet 10/100 ports with WAN firewall options. The FS-IOT-BACW model has two RS-485 ports, one Ethernet 10/100 port and supports Wi-Fi network connection. The FS-IOT-BACA, FS-IOT-BACV and FS-IOT-BACF models offer cellular connections for the chosen carrier (AT&T, Verizon or Vodafone), one RS-485 port, one Ethernet 10/100 port and supports Wi-Fi network connection.

Additionally, Wi-Fi models act as a Wi-Fi access point for modern web-based configuration and remote access from any mobile device without user restrictions.

The BACnet IoT Gateway also includes Monitor View, Data Log Viewer, Virtual Points and Event Log data analysis features that allow tracking and logging of individual device data points across the connected network in real-time.

The BACnet IoT Gateway is cloud ready and connects with MSA Safety's Grid FieldServer Manager.

**NOTE:** For cloud information, refer to the [MSA Grid - FieldServer Manager Start-up Guide](#) online through the [MSA Safety website](#).

**NOTE:** The latest versions of instruction manuals, driver manuals, configuration manuals and support utilities are available online through the [MSA Safety website](#).

## 2 Equipment Setup

### 2.1 Physical Dimensions

#### 2.1.1 FS-IOT-BAC Drawing

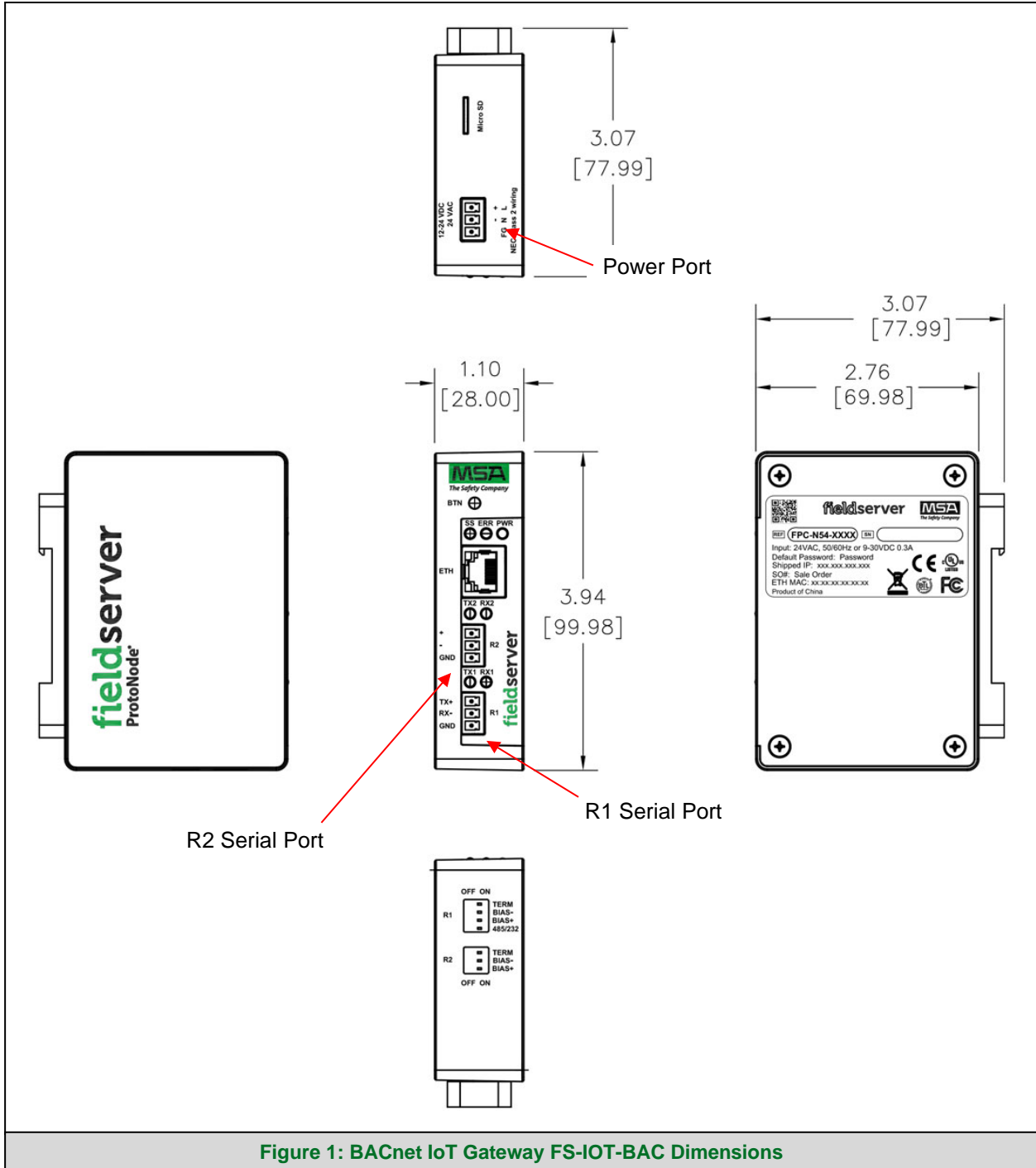

Figure 1: BACnet IoT Gateway FS-IOT-BAC Dimensions



## 2.1.2 FS-IOT-BAC2E Drawing

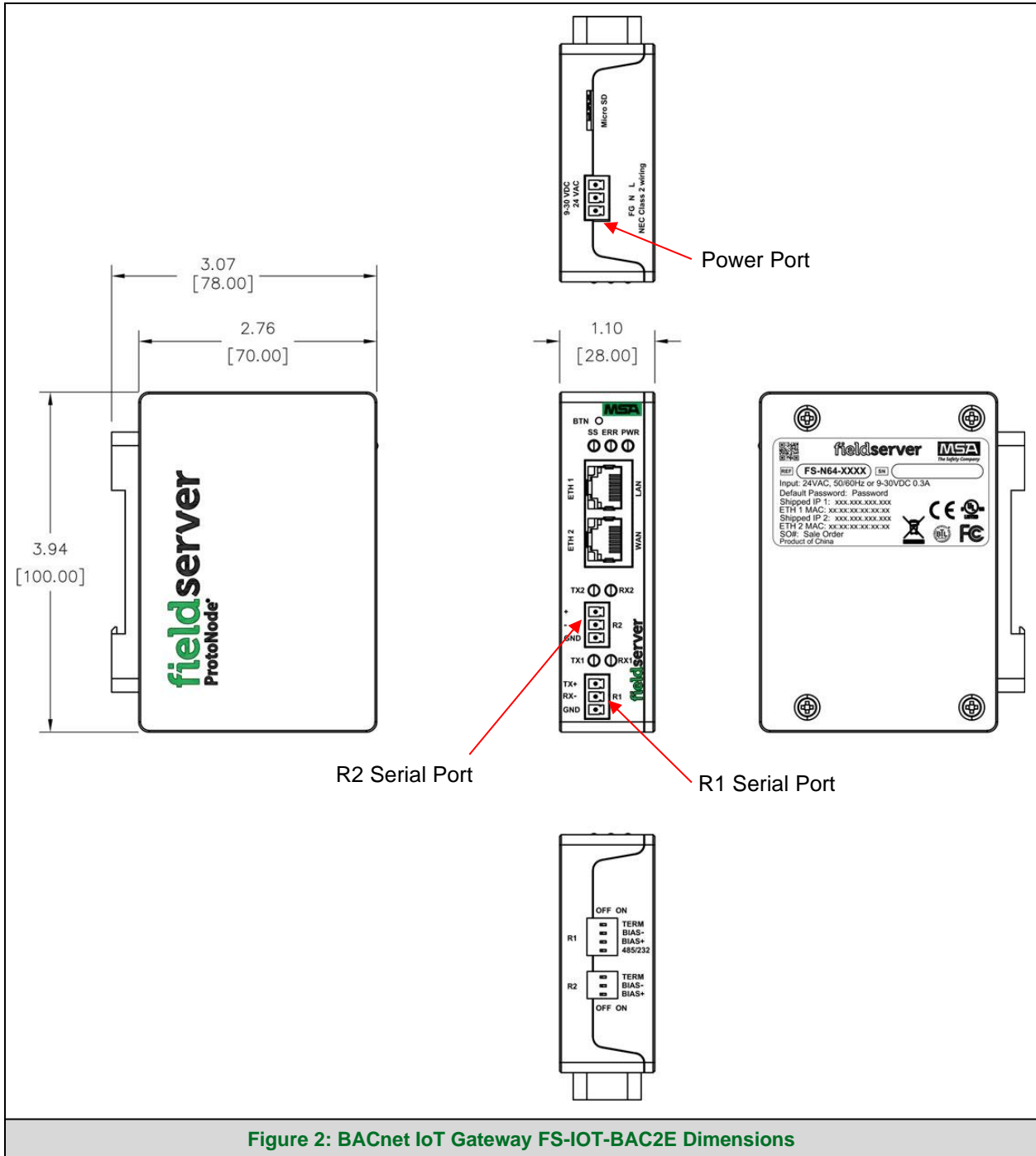

Figure 2: BACnet IoT Gateway FS-IOT-BAC2E Dimensions

## 2.1.3 FS-IOT-BACW Drawing

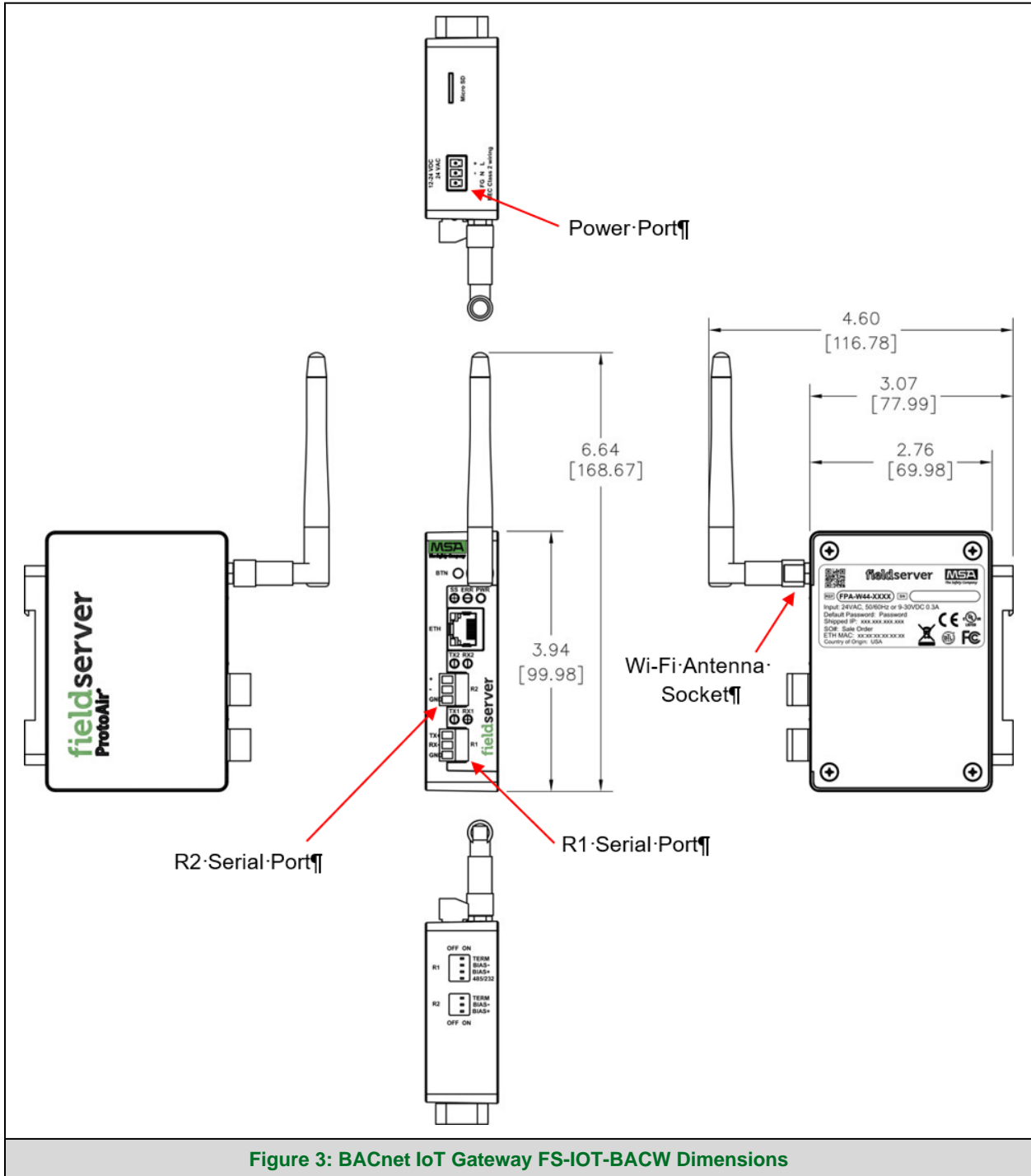
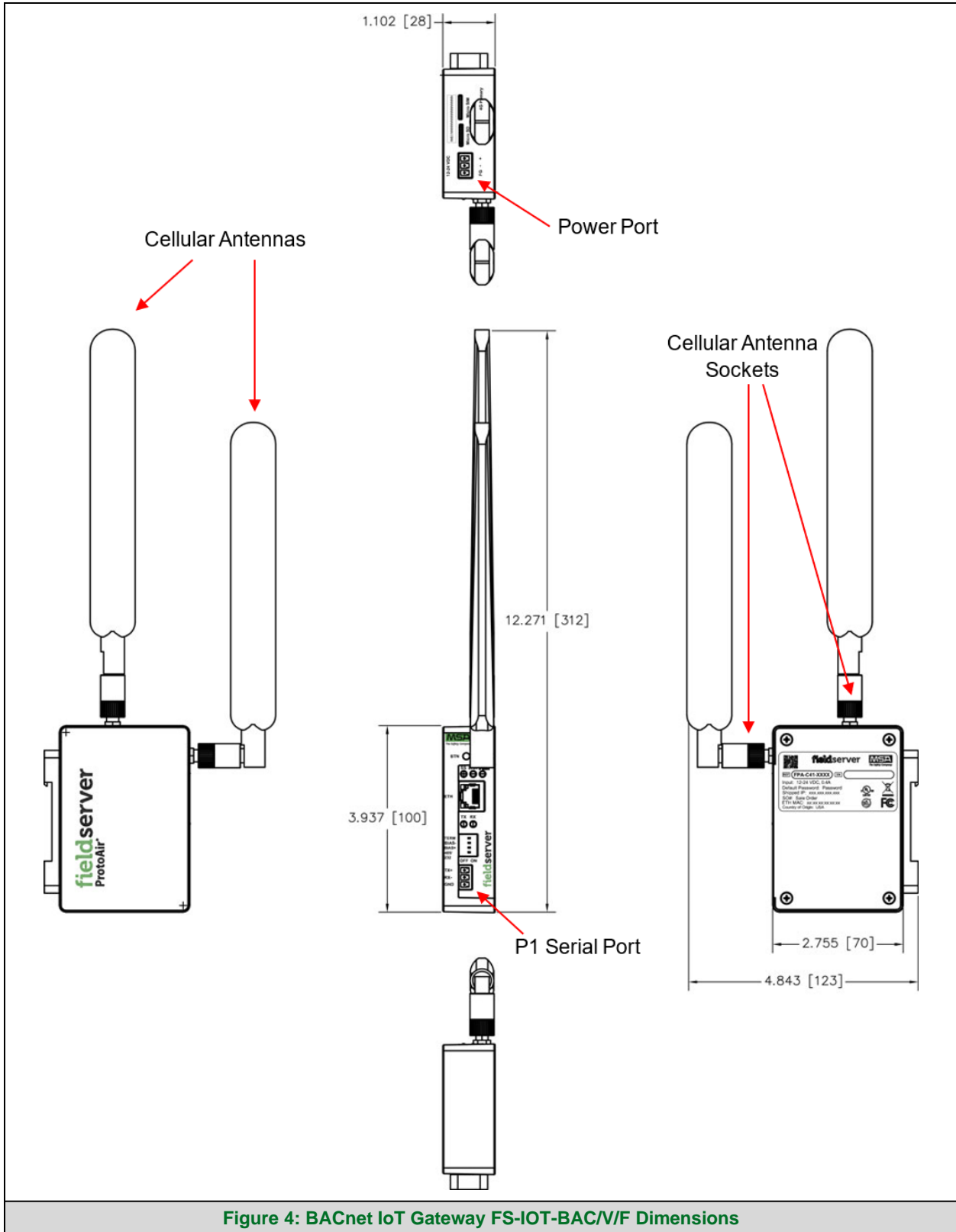

Figure 3: BACnet IoT Gateway FS-IOT-BACW Dimensions

## 2.1.4 FS-IOT-BACA/V/F Drawing



## 2.2 Mounting

The BACnet IoT Gateway can be mounted using the DIN rail mounting bracket on the back of the unit.

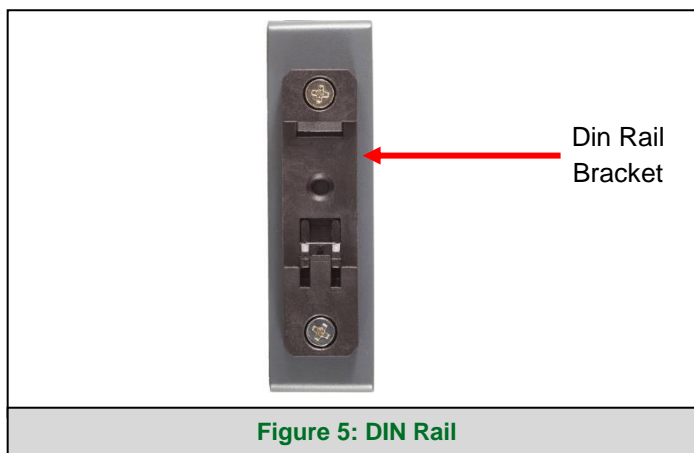

Figure 5: DIN Rail

## 2.3 Attaching the Antenna(s)

**NOTE:** This section does not apply to the FS-IOT-BAC model BACnet IoT Gateway.

### Wi-Fi Antenna:

If using the FS-IOT-BACW (Wi-Fi) model, screw in the Wi-Fi antenna to the socket on the front of the unit. For the location of the socket, see [Figure 3](#).

### Cellular Antennas:

If using the FS-IOT-BACA/V/F models, screw in the long cellular antennas into the sockets on the top and the front of the unit as shown in [Figure 4](#).

## 2.4 FS-IOT-BACA/V/F: Inserting the SIM Card

**NOTE:** A micro 4G SIM card must be purchased from an AT&T, Verizon or Vodafone cellular provider to set up cellular functionality and create a data plan for the ProtoAir. SIM card vendor contact information is available at the end of the section. The IMEI can be found by accessing the FieldServer FS-GUI page and checking the Cellular network tab under “cellular model”.

Insert the SIM card into the Micro SIM card slot with the chip on the SIM card facing away from the cellular antenna as shown below.

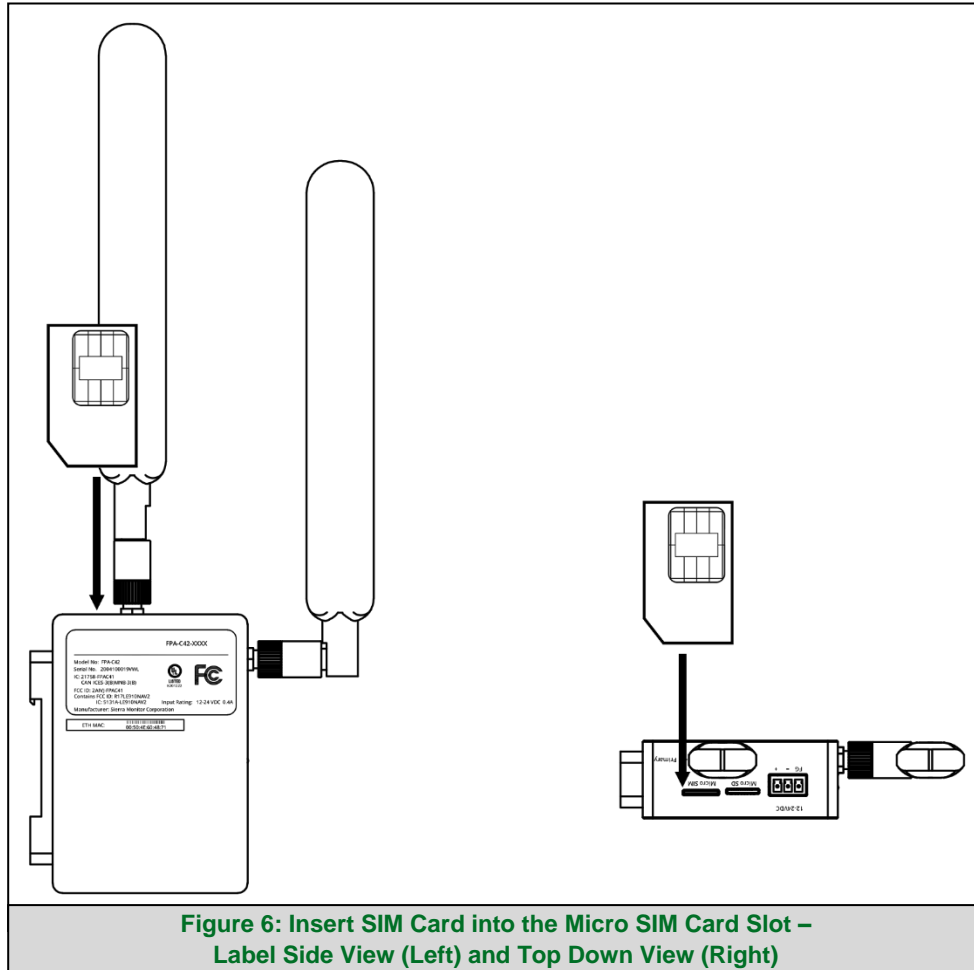

See **Section 7.1** to complete cellular setting configuration.

The table below shows cellular usage examples to forecast data usage on the chosen cellular plan.

Number of Data Points	Logging Frequency	Data Usage per Hour	Data Usage per Month
10	40 sec	0.75 Mb	547 Mb
10	900 sec	0.55 Mb	400 Mb
50	40 sec	1.24 Mb	900 Mb
50	900 sec	0.90 Mb	657 Mb
100	40 sec	3.00 Mb	2.2 Gb
100	900 sec	1.26 Mb	900 Mb
500	40 sec	10.86 Mb	7.8 Gb
500	900 sec	0.55 Mb	1.5 Gb

**Figure 7: Cellular Data Usage Examples**

### **SIM Card Vendor Contact Information:**

#### *Verizon*

A business contract is required to purchase a Verizon SIM card. The IMEI of the ProtoAir is required to purchase the Verizon SIM card.

#### *AT&T*

Please call AT&T Customer Service at 800.331.0500 or find the nearest AT&T store.

## 3 Installing the BACnet IoT Gateway

### 3.1 FS-IOT- BAC/BACW/BAC2E: Connecting the R1 & R2 Ports

**NOTE:** Ensure RS-485 is selected for R1 by checking that the number 4 DIP Switch is set to the left side.

Connect to the 3-pin connector(s) as shown below.

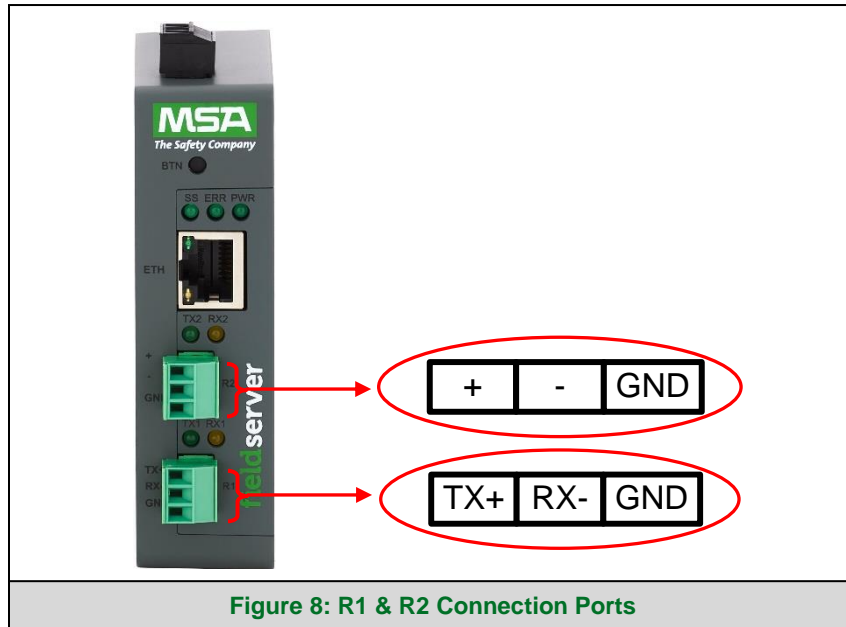

Figure 8: R1 & R2 Connection Ports

The following baud rates are supported for both ports:  
9600, 19200, 38400, 76800

#### 3.1.1 Wiring

RS-485	
BMS RS-485 Wiring	Gateway Pin Assignment
RS-485 +	TX +
RS-485 -	RX -
GND	GND

**NOTE:** Use standard grounding principles for GND.

# Installing the BACnet IoT Gateway

## 3.2 FS-IOT-BACA/V/F: Connecting the P1 Port

**NOTE:** Ensure RS-485 is selected by checking that the number 4 DIP Switch is set to the left side.

Connect to the 3-pin connector as shown below.



Figure 9: RS-485 P1 Connection Port

The following Baud Rates are supported on the P1 Port:  
9600, 19200, 38400, 76800

### 3.2.1 Wiring

RS-485	
BMS RS-485 Wiring	BACnet IoT Gateway Pin Assignment
RS-485 +	TX +
RS-485 -	RX -
GND	GND

**NOTE:** Use standard grounding principles for GND.



## 3.3 10/100 Ethernet Connection Port

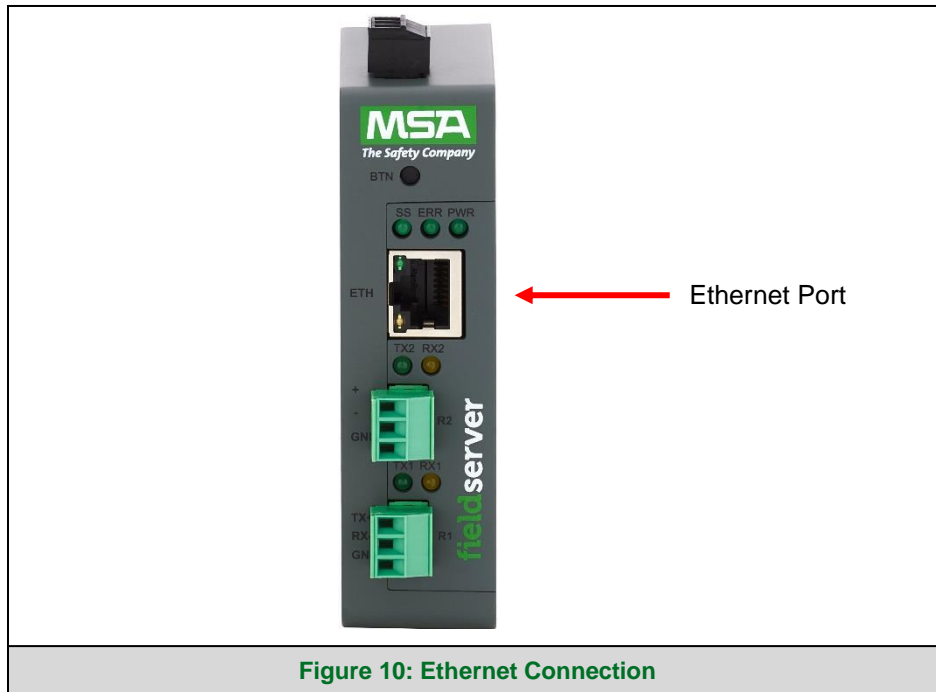

Figure 10: Ethernet Connection

The Ethernet Port is used both for BACnet/IP communications and for configuring the BACnet IoT Gateway via the Web App. To connect the BACnet IoT Gateway, either connect the PC to the Gateway's Ethernet port or connect the Gateway and PC to an Ethernet switch. Use Cat-5 cables for the connection.

**NOTE: The Default IP Address of the BACnet IoT Gateway is 192.168.2.101, Subnet Mask is 255.255.255.0.**

## 4 Power up the BACnet IoT Gateway

Check power requirements in the table below:

Power Requirement for BACnet IoT Gateway External Gateway			
BACnet IoT Gateway Family	Current Draw Type		
	12VDC	24VDC	24VAC
FS-IOT-BAC/BACW/BAC2E (Typical)	250mA	125mA	125mA
FS-IOT-BACA/V/F (Typical)	320mA	185mA	N/A
FS-IOT-BACA/V/F (Maximum)	670mA	390mA	N/A
<b>NOTE: These values are 'nominal' and a safety margin should be added to the power supply of the host system. A safety margin of 25% is recommended.</b>			
<b>Figure 11: Required Current Draw for the BACnet IoT Gateway</b>			

Apply power to the BACnet IoT Gateway as shown below. Ensure that the power supply used complies with the specifications provided. Ensure that the cable is grounded using the FG or "Frame GND" terminal.

- The **FS-IOT-BAC/BACW/BAC2E** BACnet IoT Gateway accepts 9-30VDC or 24VAC.
- The **FS-IOT-BACA/V/F** BACnet IoT Gateways accept 12-24VDC.

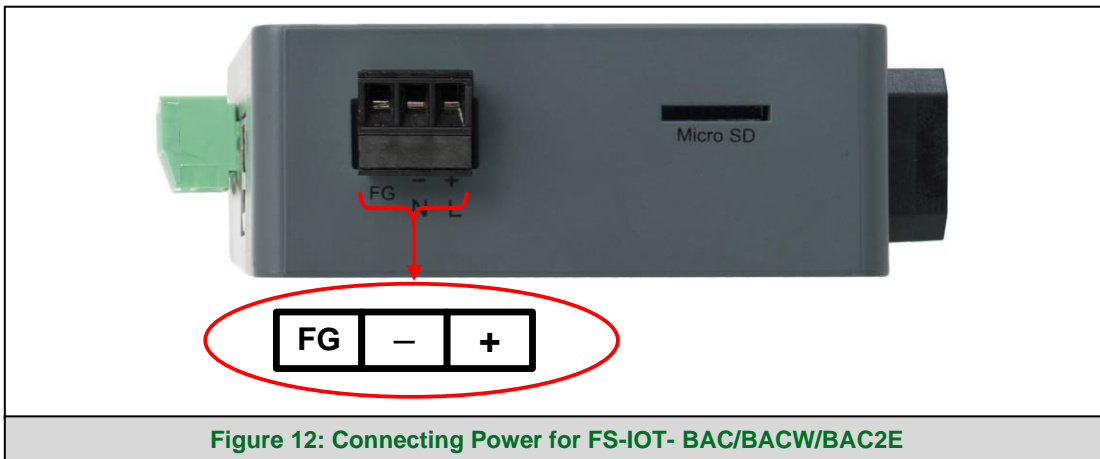

**Figure 12: Connecting Power for FS-IOT-BAC/BACW/BAC2E**

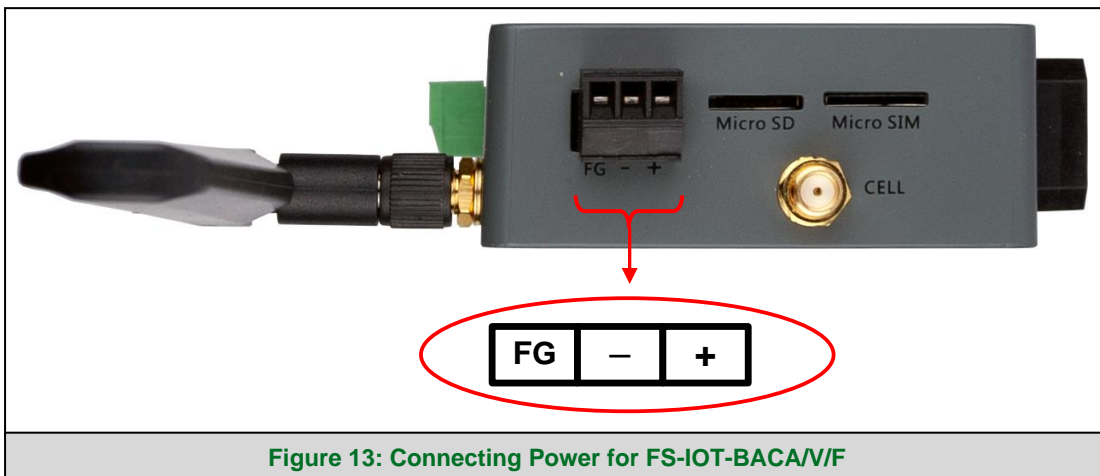

**Figure 13: Connecting Power for FS-IOT-BACA/V/F**

## 5 Connecting to the BACnet IoT Gateway

The FieldServer Toolbox Application can be used to discover and connect to the BACnet IoT Gateway on a local area network. To manually connect to the BACnet IoT Gateway using the Toolbox, click on the plus icon ( + ) and enter the IP Address, or enter the Internet IP Address into a web browser.

### 5.1 Using the FieldServer Toolbox

- Install the Toolbox application from the USB drive or get it from the [MSA Safety website](#).
- Use the Toolbox application to find the BACnet IoT Gateway IP Address and launch the Web App (by clicking the Connect button).

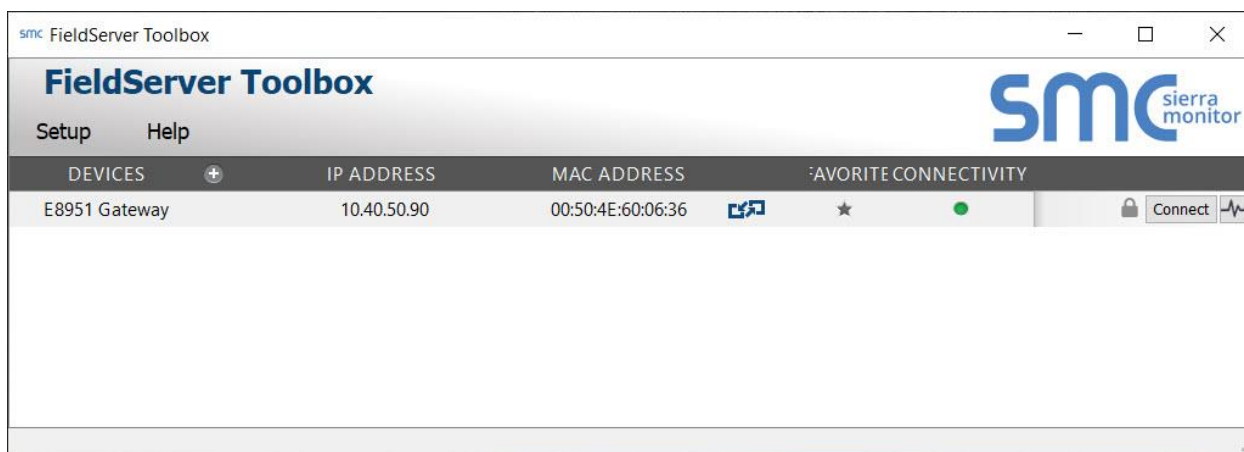

### 5.2 Using a Web Browser

Open a Web Browser and input the BACnet IoT Gateway's IP Address. The Default IP Address of the BACnet IoT Gateway is **192.168.2.101**, Subnet Mask is **255.255.255.0**. If the PC and the BACnet IoT Gateway are on different IP Networks, assign a Static IP Address to the PC on the 192.168.2.X network.

**NOTE:** Check Section **14.10** for supported browsers.

## 6 Setup Web Server Security

### 6.1 Login to the FieldServer

The first time the FieldServer GUI is opened in a browser, the IP Address for the gateway will appear as untrusted. This will cause the following pop-up windows to appear.

- When the Web Server Security Unconfigured window appears, read the text and choose whether to move forward with HTTPS or HTTP.



- When the warning that “Your connection is not private” appears, click the advanced button on the bottom left corner of the screen.

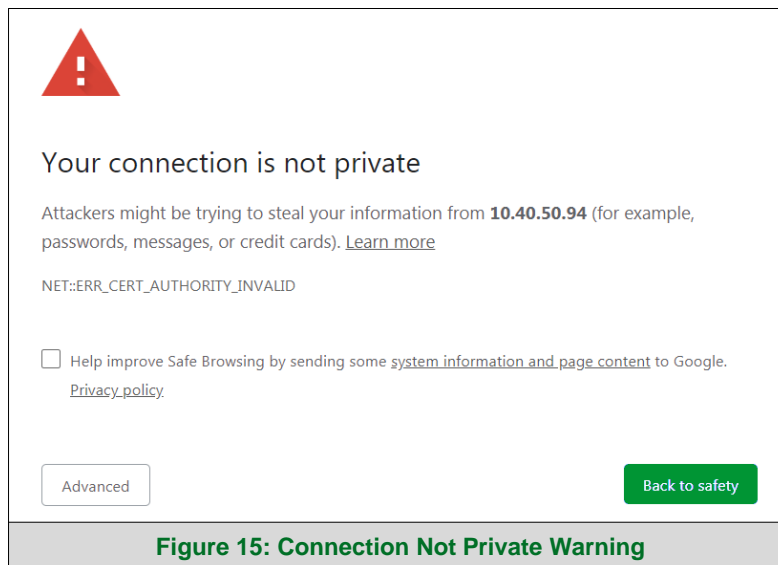

## Setup Web Server Security

- Additional text will expand below the warning, click the underlined text to go to the IP Address. In the **Figure 16** example this text is “[Proceed to 10.40.50.94 \(unsafe\)](#)”.

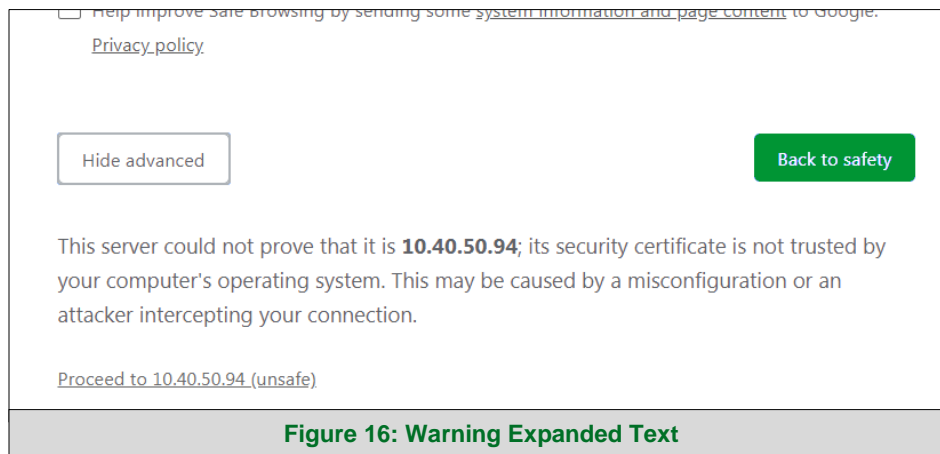

- When the login screen appears, put in the Username (default is “admin”) and the Password (found on the label of the FieldServer).

**NOTE:** There is also a QR code in the top right corner of the FieldServer label that shows the default unique password when scanned.

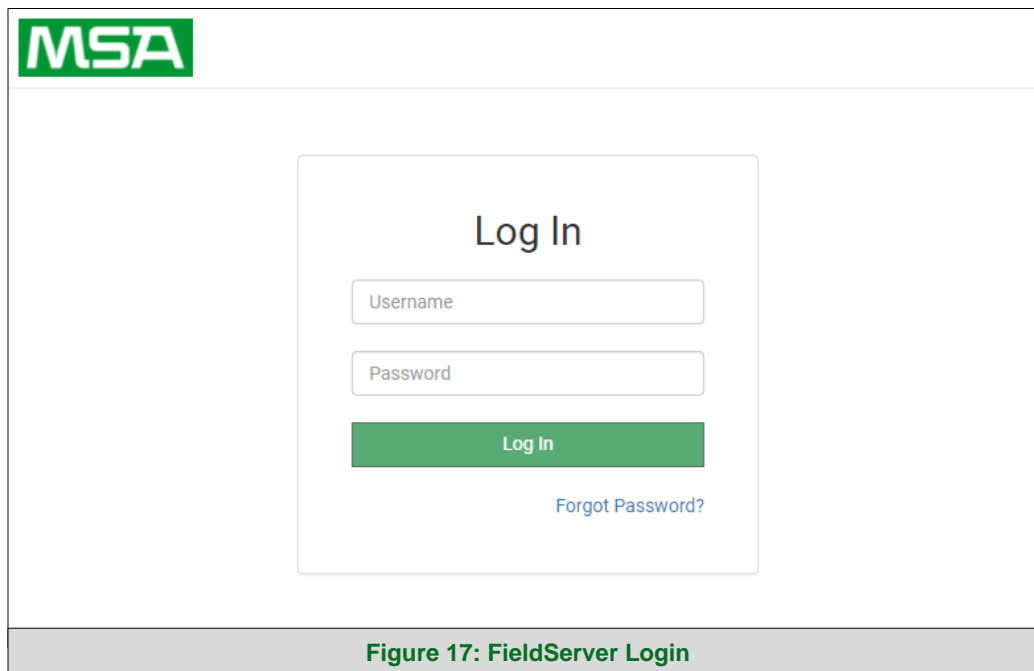

**NOTE:** A user has 5 attempts to login then there will be a 10-minute lockout. There is no timeout on the FieldServer to enter a password.

**NOTE:** To create individual user logins, go to **Section 15.3**.

## 6.2 Select the Security Mode

On the first login to the FieldServer, the following screen will appear that allows the user to select which mode the FieldServer should use.

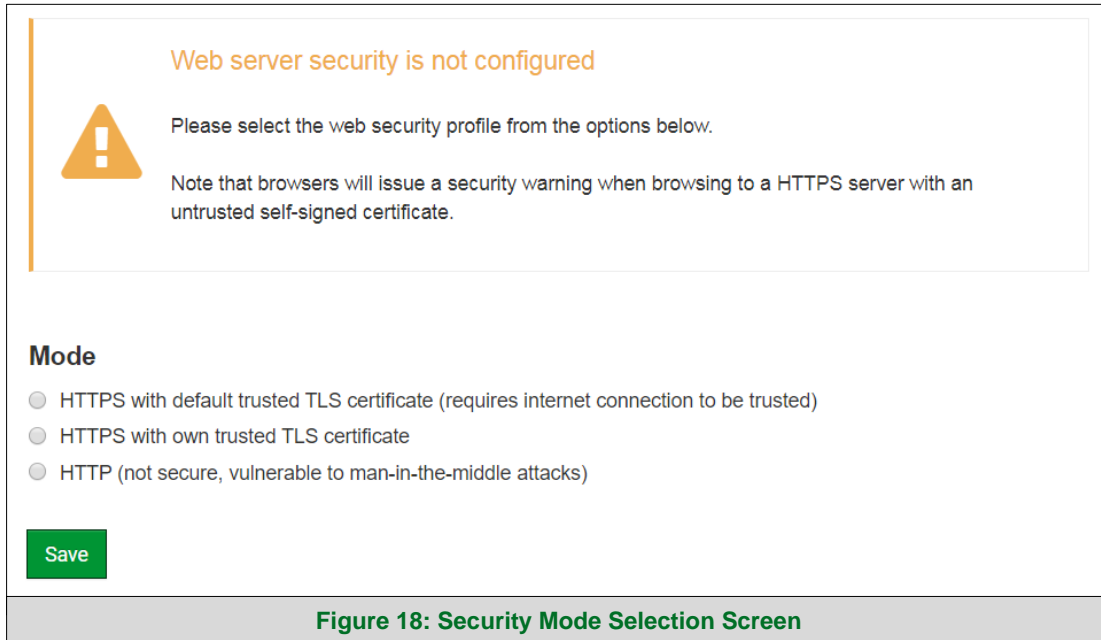

**NOTE: Cookies are used for authentication.**

**NOTE: To change the web server security mode after initial setup, go to Section 15.2.**

The sections that follow include instructions for assigning the different security modes.

## 6.2.1 HTTPS with Own Trusted TLS Certificate

This is the recommended selection and the most secure. **Please contact your IT department to find out if you can obtain a TLS certificate from your company before proceeding with the Own Trusted TLS Certificate option.**

- Once this option is selected, the Certificate, Private Key and Private Key Passphrase fields will appear under the mode selection.

The screenshot shows a web form titled "Security Mode Selection Screen – Certificate & Private Key". It contains three main sections:

- Certificate:** A text area containing a long alphanumeric string representing a certificate, starting with "XzyMbQZFIRuJZJPe7CTHLcHOrHLowoUFoVtaBMYd4d6VGdNklKazByWKcNOL7mrX" and ending with "-----END CERTIFICATE-----".
- Private Key:** A text area containing a long alphanumeric string representing a private key, starting with "sHB0zZoHr4YQSDK2BbYVzzbl0LDuKtc8+JiO3ooGjoTuHnqkeAj/fkfbTAsKeAzw" and ending with "-----END RSA PRIVATE KEY-----".
- Private Key Passphrase:** A text input field with the placeholder text "Specify if encrypted".

At the bottom of the form is a green "Save" button.

**Figure 19: Security Mode Selection Screen – Certificate & Private Key**

- Copy and paste the Certificate and Private Key text into their respective fields. If the Private Key is encrypted type in the associated Passphrase.
- Click Save.
- A “Redirecting” message will appear. After a short time, the FieldServer GUI will open.

## 6.2.2 HTTPS with Default Untrusted Self-Signed TLS Certificate or HTTP with Built-in Payload Encryption

- Select one of these options and click the Save button.
- A “Redirecting” message will appear. After a short time, the FieldServer GUI will open.

## 7 Gateway Settings

### 7.1 Navigate to the Settings

- From the Web App landing page, click the Settings tab on the left side of the screen.

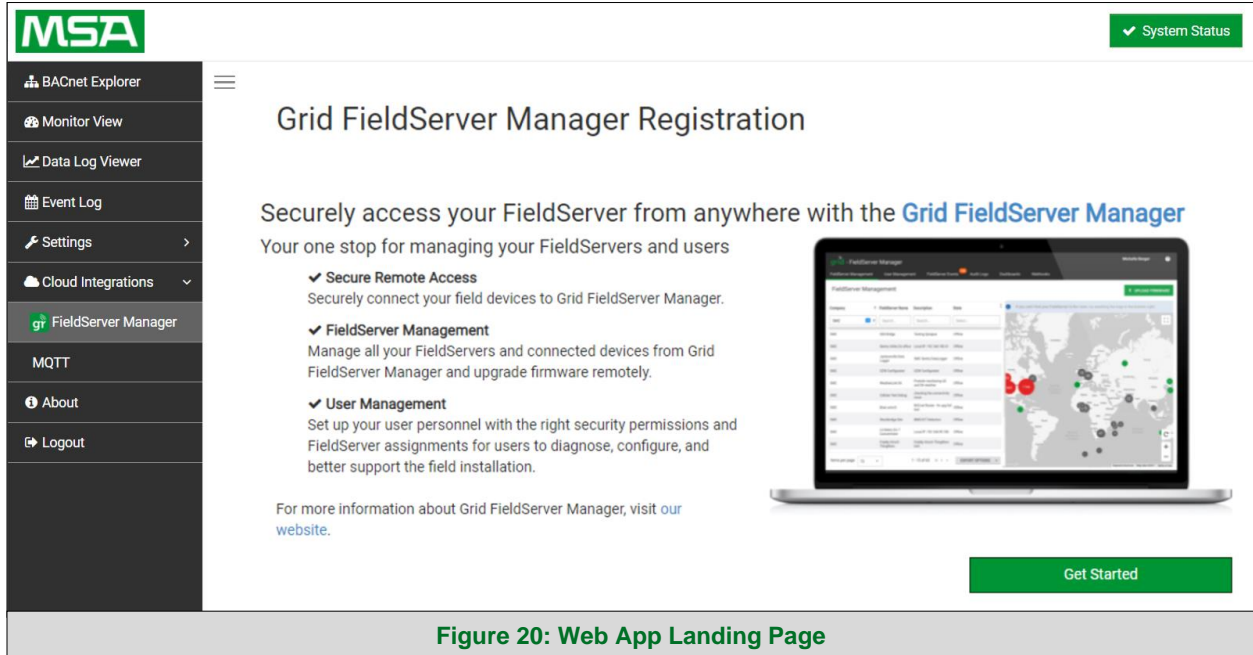

The BACnet IoT Gateway settings are split up into three types: Local Settings, Remote Settings and Network Settings.

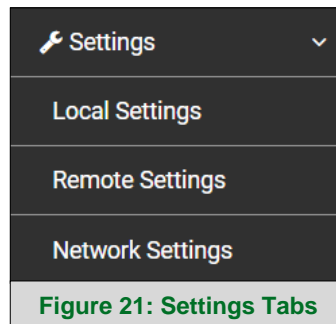

- A warning message will appear when performing the first-time setup, click the Exit Registration button to continue to the selected settings.

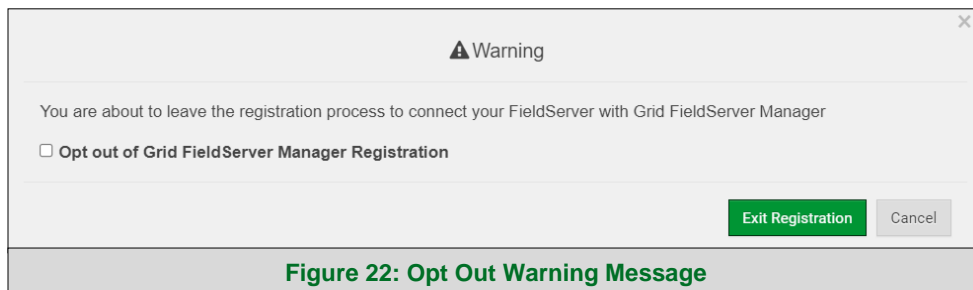



# Configuring the BACnet IoT Gateway

The following sections explain the setting parameters by type for BACnet IoT Gateway configuration.

The table below describes how the buttons at the bottom of each page function.

Button	Definition
Save	Click to save settings. Saving will require the device to be restarted.
Refresh	Click to clear the current settings before saving; if settings have been saved the Refresh button is unavailable.
Defaults	Click to change settings back to factory defaults.

**Figure 23: Configuration Button Functions**

## 7.1.1 ETH 1 IP Settings

The ETH 1 tab is the landing page when selecting the Network Settings tab. To change the FieldServer IP Settings, follow these instructions:

- Enable DHCP to automatically assign IP Settings or modify the IP Settings manually as needed, via these fields: IP Address, Netmask, Default Gateway, and Domain Name Server1/2.

**NOTE: If connected to a router, set the Gateway to the same IP Address as the router.**

- Click the Save button to activate the new settings.

**NOTE: If the webpage was open in a browser, the browser will need to be pointed to the new IP Address before the webpage will be accessible again.**

**Figure 24: ETH 1 Port Network Settings**

IP Setting Fields	Definition
Connection Status	Status of connection
MAC Address	Ethernet MAC Address
Tx/Rx Msgs	Number of transmitted and received messages
Tx/Rx Msgs Dropped	Number of unanswered Tx or Rx messages

# Configuring the BACnet IoT Gateway

## 7.1.2 Wi-Fi Client

- Set the Wi-Fi Status to ENABLED for the ProtoAir to communicate with other devices via Wi-Fi.
- Enter the Wi-Fi SSID and Wi-Fi Password for the local wireless access point.
- Enable DHCP to automatically assign all Wi-Fi Client Settings fields or modify the Settings manually, via the fields immediately below the note (IP Address, Network, etc.).

**NOTE: If connected to a router, set the IP gateway to the same IP Address as the router.**

- Click the Save button to activate the new settings.
- Go to Router settings (**Section 7.1.4**) to set the default connection to Wi-Fi Client.

The screenshot displays the 'Wi-Fi Client' configuration interface. It includes a navigation bar with tabs for 'ETH 1', 'WiFi Client', 'WiFi Access Point', 'Cellular LTE', and 'Routing'. The 'WiFi Client' tab is active. The main area contains several settings:
 

- Enable:** A checked checkbox.
- SSID:** A text field containing 'FieldSVR'.
- Password (Optional):** A masked text field with a toggle for visibility.
- Enable DHCP:** A checked checkbox.
- IP Address:** A text field containing '10.40.50.57'.
- Netmask:** A text field containing '255.255.255.0'.
- Gateway:** A text field containing '10.40.50.1'.
- Domain Name Server 1 (Optional):** A text field containing '10.5.4.77'.
- Domain Name Server 2 (Optional):** A text field containing '10.40.2.24'.

 At the bottom left are 'Cancel' and 'Save' buttons. On the right, a 'Network Status' box shows:
 

- Connection Status:** Connected (with a green checkmark).
- MAC Address:** D4:53:83:08:0A:5A
- WiFi BSSID:** 78:BC:1A:52:C8:42
- WiFi Channel:** 2,462
- WiFi Tx Msgs:** 62
- WiFi Rx Msgs:** 49
- WiFi Tx Msgs Dropped:** 0
- WiFi Rx Msgs Dropped:** 0
- WiFi Pairwise Cipher:** CCMP
- WiFi Group Cipher:** CCMP
- WiFi Key Mgmt:** WPA2-PSK
- WiFi Link:** 65.0 MBit/s MCS 7
- WiFi Signal Level:** -56 dBm

**Figure 25: Wi-Fi Client Network Settings**

Wi-Fi Client Fields	Definition
Connection Status	Status of connection
MAC Address, BSSID, Channel	Wi-Fi Client MAC Address, BSSID, and Channel
Tx/Rx Msgs	Number of transmitted and received messages
Tx/Rx Msgs Dropped	Number of unanswered Tx or Rx messages
Pairwise Cipher	Type of encryption used for unicast traffic
Group Cipher	Identifies the type of encryption used for multicast / broadcast traffic
Key Mgmt	Encryption type
Link	Connection speed
Signal Level	Signal level in dBm (see <b>Section 14.8</b> )

# Configuring the BACnet IoT Gateway

## 7.1.3 Wi-Fi Access Point

- Check the Enable tick box to allow connecting to the ProtoAir via Wi-Fi Access Point.
- Modify the Settings manually as needed, via these fields: SSID, Password, Channel, IP Address, Netmask, IP Pool Address Start, and IP Pool Address End.

**NOTE: The default channel is 11. The default IP Address is 192.168.50.1.**

- Click the Save button to activate the new settings.

**NOTE: If the webpage was open in a browser via Wi-Fi, the browser will need to be updated with the new Wi-Fi details before the webpage will be accessible again.**

The screenshot shows the configuration interface for the Wi-Fi Access Point. The 'WiFi Access Point' tab is active. The 'Enable' checkbox is checked. The SSID is 'ProtoAir-60487A', the password is '12345678', and the channel is set to 11. The 'Allow others to find this network' checkbox is also checked. The IP address is 192.168.50.1, with a netmask of 255.255.255.0. The IP pool address range is from 192.168.50.120 to 192.168.50.130. A 'Network Status' box on the right indicates the connection is enabled and shows zero messages transmitted or received. 'Cancel' and 'Save' buttons are located at the bottom left of the form.

**Figure 26: Wi-Fi AP Network Settings**

Wi-Fi AP Fields	Definition
Connection Status	Status of connection
MAC Address	Access Point's MAC Address
Tx/Rx Msgs	Number of transmitted and received messages
Tx/Rx Msgs Dropped	Number of unanswered Tx or Rx messages

# Configuring the BACnet IoT Gateway

## 7.1.4 Routing

The Routing settings make it possible to set up the IP routing rules for the FieldServer's internet and network connections.

**NOTE: The default connection is ETH1.**

- Select the default connection in the first row.
- Click the Add Rule button to add a new row and set a new Destination Network, Netmask and Gateway IP Address as needed.
- Set the Priority for each connection (1-255 with 1 as the highest priority and 255 as the lowest).
- Click the Save button to activate the new settings.

**NOTE: If using Wi-Fi Client and not Ethernet, make the top priority rule a Wi-Fi Client connection.**

The screenshot shows the 'Routing' configuration page. At the top, there are tabs for 'ETH 1', 'WiFi Client', 'WiFi Access Point', 'Cellular LTE', and 'Routing'. Below the tabs, there is a heading 'Set up the IP routing rules of your FieldServer for internet access and access to other networks.' followed by a sub-heading 'If you want to reach another device that is not connected to the local network, you can add a rule to determine on which gateway the device must be routed to.'

Interface	Destination Network	Netmask	Gateway IP Address	Priority ⓘ
ETH 1	Default	-	10.40.50.1	255
ETH 1	10.40.0.0	255.255.0.0	10.40.50.1	254
ETH 1	10.136.0.0	255.255.0.0	10.40.50.1	100

Below the table, there is a '+ Add Rule' button, a 'Cancel' button, and a 'Save' button.

Figure 27: Routing Network Settings

# Configuring the BACnet IoT Gateway

## 7.1.5 FS-IOT-BACA/V/F: Cellular LTE

To change the Cellular settings, follow these instructions:

- Check the Enable tick box to allow connecting to the ProtoAir through the Grid.
- Modify the Settings manually as needed, via these fields: Cellular APN (see **Section 14.11**), User Name, and Password.
- Click the Save button to activate the new settings.

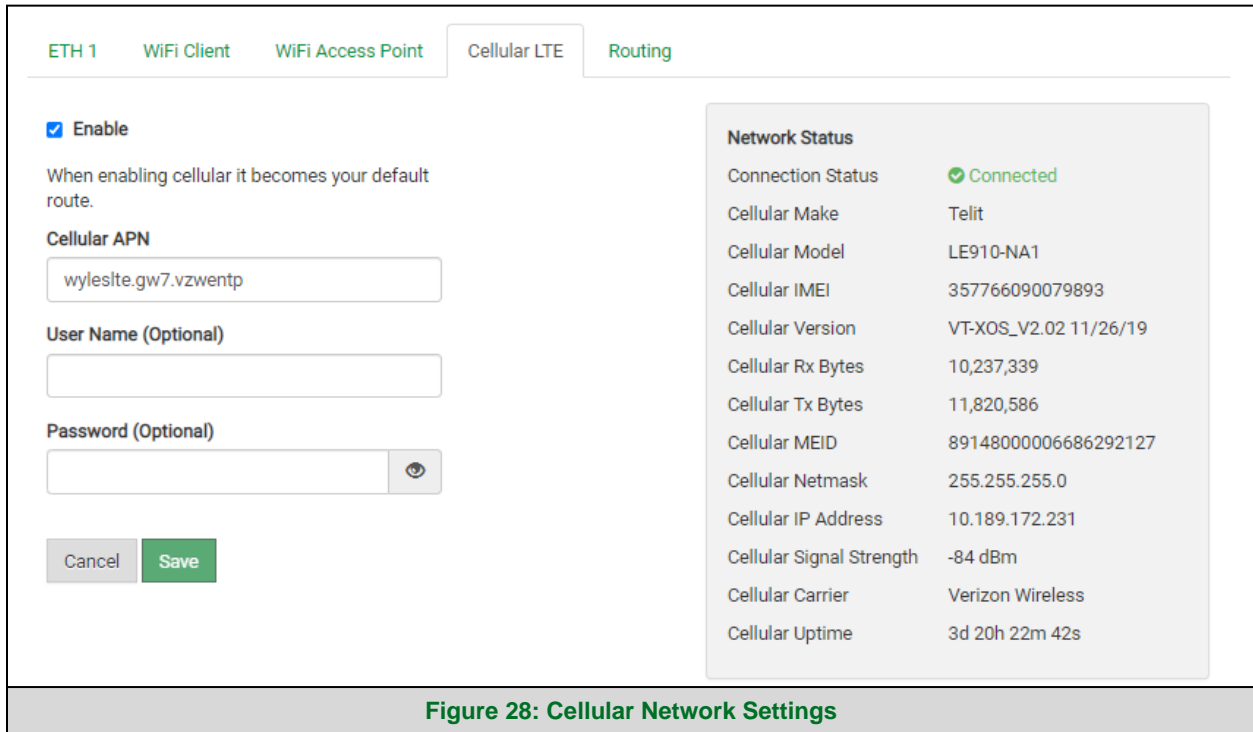

Figure 28: Cellular Network Settings

Cellular Fields	Definition
Connection Status	Status of connection
Uptime	Length of time connected
Signal Strength	Strength of signal in dBm (see 14.8)
Signal Type	Type of Signal
Tx/Rx Bytes	Receive and transmit bytes
MEID	Mobile Equipment ID; unique id for a device
Carrier	Cellular carrier provider
IP Address/Netmask	IP Address and Netmask of the cellular connection
Make/Model/Version	Vendor, model and software version of the internal cellular chip

# Configuring the BACnet IoT Gateway

## 7.1.6 FS-IOT-BAC2E: Ethernet 2 Network Settings – LAN Mode

- Check that the Mode is set to LAN, if not click LAN to change the ETH 2 port to LAN mode.
- Enable DHCP to automatically assign IP Settings or modify the IP Settings manually as needed, via these fields: IP Address, Netmask, Gateway, and Domain Name Server1/2.

**NOTE: If the FieldServer is connected to a router, the IP Gateway of the FieldServer should be set to the same IP Address of the router.**

- Scroll down to the bottom of the page and click the Save button to activate the new settings.

**NOTE: If the webpage was open in a browser, the browser will need to be pointed to the new IP Address before the webpage will be accessible again.**

The screenshot displays the 'Ethernet 2 Network Settings' interface. At the top, there are three tabs: 'ETH 1', 'ETH 2', and 'Routing'. The 'ETH 2' tab is selected. Below the tabs, the 'Mode' section has two buttons: 'WAN' and 'LAN', with 'LAN' being the active mode. There is an unchecked checkbox for 'Enable DHCP'. The 'IP Address' field contains '192.168.2.25', the 'Netmask' field contains '255.255.255.0', the 'Gateway' field contains '192.168.2.1', 'Domain Name Server 1 (Optional)' contains '8.8.8.8', and 'Domain Name Server 2 (Optional)' contains '8.8.4.4'. On the right side, a 'Network Status' box shows 'Connection Status' as 'Connected' with a green checkmark, 'MAC Address' as '00:50:4e:60:45:1b', 'Ethernet Tx Msgs' as '14,210,944', 'Ethernet Rx Msgs' as '77,137,100', and two 'Dropped' counts (Tx and Rx) as '0'. At the bottom of the screenshot, a caption reads 'Figure 29: Ethernet 2 Port Network Settings'.

# Configuring the BACnet IoT Gateway

## 7.1.7 FS-IOT-BAC2E: Ethernet 2 Network Settings – WAN Mode

- Click the WAN box to change the ETH 2 port to WAN mode.
  - This prevents all incoming traffic on the ETH 2 port but it allows a connection to the internet via port 80 & 443
- Scroll below the network settings to get to the firewall options with rules that allow specific incoming traffic (through setting rules) and outgoing options.

**Incoming Firewall (Optional)**  
All incoming network traffic is blocked by default. You can use the incoming firewall rules to allow specified traffic to the FieldServer from the WAN network. ?

**Shorthand tips** When you add rules, you can use the following symbols

IP Address	Netmask (Optional)	Port Range	Description (Optional)
*		80,443,1024	Webpage and FieldServer Toc

+ Add Rule

Cancel Save

**Figure 30: Ethernet 2 Port Firewall Settings**

### NOTE the following options for setting firewall rules:

- Add 1023 to the Port Range field to allow the FieldServer Toolbox access.
- Add 47808 to the Port Range field for BACnet access.
- Add 80 & 443 to the Port Range field for web browser access.
- Use a "\*" as a wild card for IP Address.

# Configuring the BACnet IoT Gateway

## 7.2 Local Settings – BACnet

Enter the fields for the settings described below as needed:

The screenshot shows a configuration interface with the following sections and fields:

- Connection Settings** (header)
- BACnet IP Settings** (header)
  - Network Number: 60001
  - IP Port: 47808
- BACnet MSTP Settings** (header)
  - Network Number: 60002
  - MAC Address: 0
  - Max Master: 127
  - Max Info Frames: 50
  - BAUD Rate: 38400 (dropdown menu)
  - Token Usage Timeout (ms): 50 (dropdown menu)
- Internal Settings** (header)
  - Internal BACnet Network Number: 60003

**Figure 31: Connection Settings**

Parameter	Definition
<b>All Connections</b>	
Network Number	The BACnet network number for the connection. Legal values are 1-65534. Each network number must be unique across the entire BACnet internetwork. The <b>Internal Network Number</b> is used for internal BACnet traffic and has to be unique across the BACnet network.
<b>BACnet/IP Settings</b>	
IP Port	The BACnet/IP default is 47808 (0xBAC0), but other port numbers can be specified.
<b>BACnet MS/TP Settings</b>	
MAC Address	Legal values are 0-127, must be unique on the physical network.
Max Master	The highest MAC address to scan for other MS/TP master devices. The default of 127 is guaranteed to discover all other MS/TP master devices on the network.
Max Info Frames	The number of transactions the BACnet IoT Gateway may initiate while it has the MS/TP token. Default is 50.
BAUD Rate	The serial baud rate used on the network.
Token Usage Timeout (ms)	The number of milliseconds the router will wait before deciding that another master has dropped the MS/TP token. This value must be between 20ms and 100ms. Choose a larger value to improve reliability when working with slow MS/TP devices that may not be able to meet strict timing specifications.

**Figure 32: Connection Parameters**



# Configuring the BACnet IoT Gateway

## 7.3 Remote Settings – Foreign Device Registration for BBMD Support

The BACnet IoT Gateway uses “Foreign Device Registration” or “FDR” to communicate to BACnet/IP devices on another network. Follow the instructions below to enable FDR between the BACnet IoT Gateway and a remote network:

- Click the “Enabled” checkbox under the Foreign Device Registration section of the BACnet Settings.

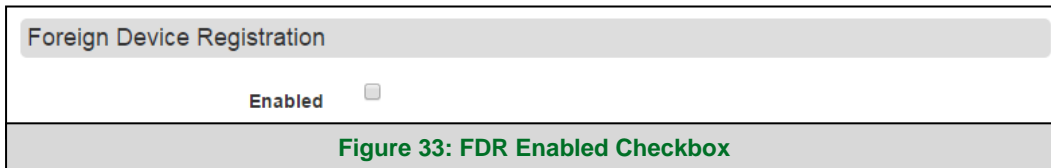

**Figure 33: FDR Enabled Checkbox**

- Enter the Remote BACnet Router’s externally mapped IP Address and BACnet/IP Port to the appropriate Foreign Device Registration fields. This allows the BACnet IoT Gateway to discover BACnet devices on the remote network.

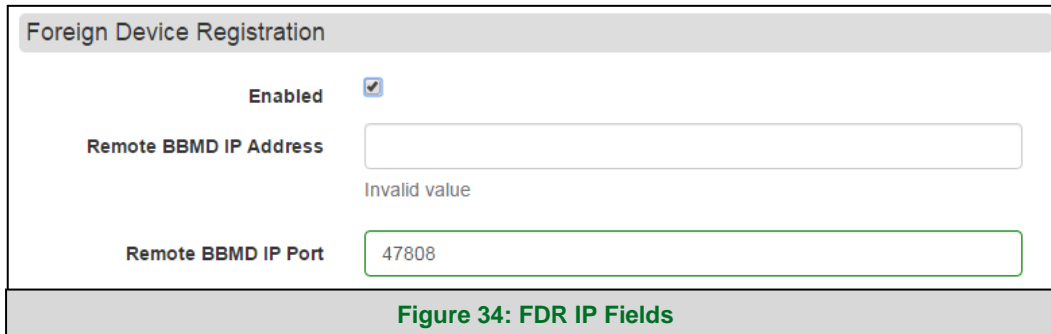

**Figure 34: FDR IP Fields**

**NOTE:** The user must uncheck the “Enabled” checkbox to allow the BACnet IoT Gateway to discover on the local network.

**NOTE:** See Section 13 for additional details concerning FDR and BBMD.

## 8 Using the BACnet IoT Gateway

Sections 7.1 – 7.4 represent each of the first four tabs that appear across the left side of the page once logged into the BACnet IoT Gateway and describe their functions.

### 8.1 BACnet Explorer

Click on the BACnet Explorer tab on the left side of the page to open the BACnet Explorer page.

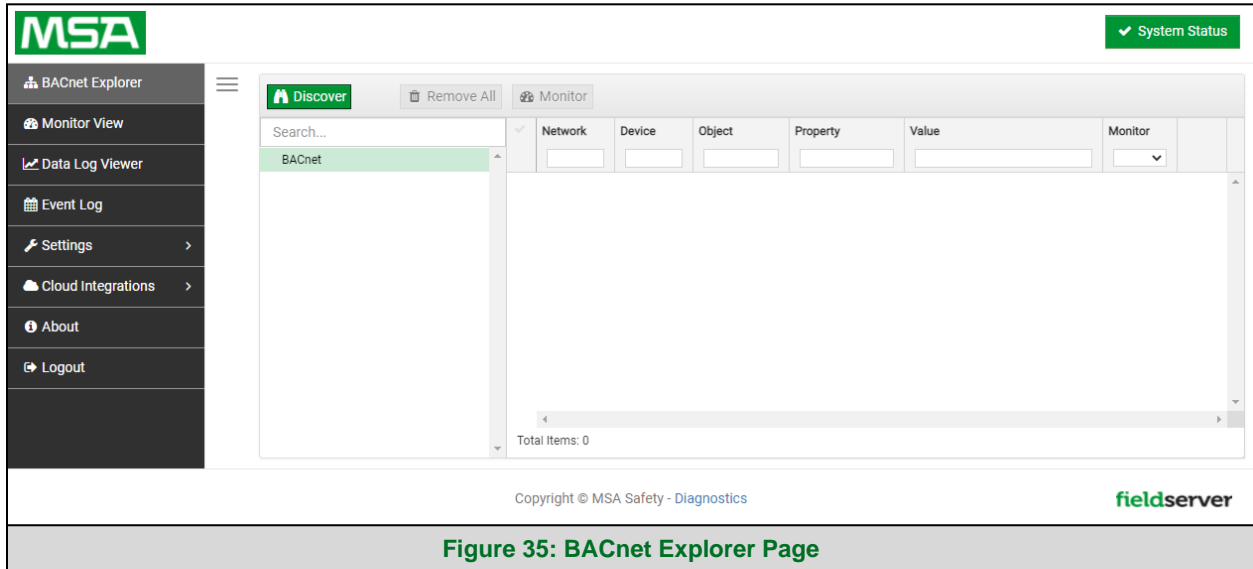

Figure 35: BACnet Explorer Page

## 8.1.1 Discover the Device List

- To discover the devices connected to the same subnet as the BACnet IoT Gateway, click the Discover button  (binocular icon).
- This will open the Discovery window, click the checkboxes next to the desired discovery settings and click Discover to start the search.



Figure 36: Discovery Window

**NOTE:** The “Discover All Devices” or “Discover All Networks” checkboxes must be unchecked to search for a specific device range or network.

Allow the devices to populate before interacting with the device list for optimal performance. Any discovery or explore process will cause a green message to appear in the upper right corner of the browser to confirm that the action is complete.

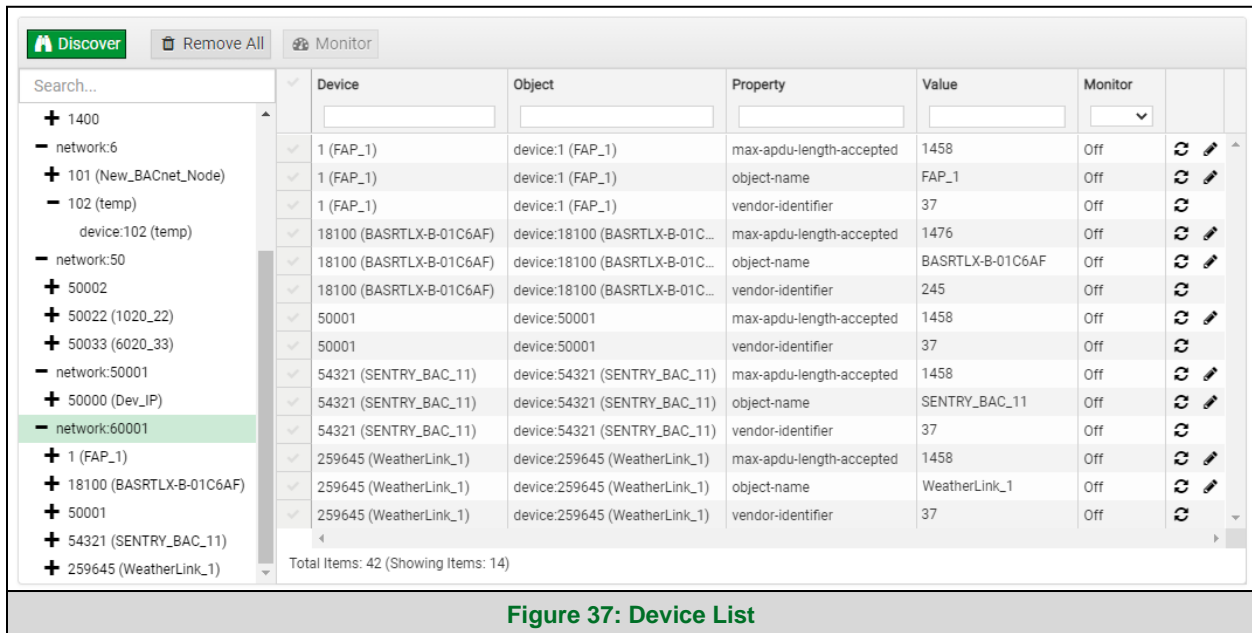

Figure 37: Device List

## 8.1.2 View Device Details and Explore Points/Parameters

- To view the device details, click the blue plus sign (+) next to the desired device in the list.
  - This will show only some of the device properties for the selected aspect of a device

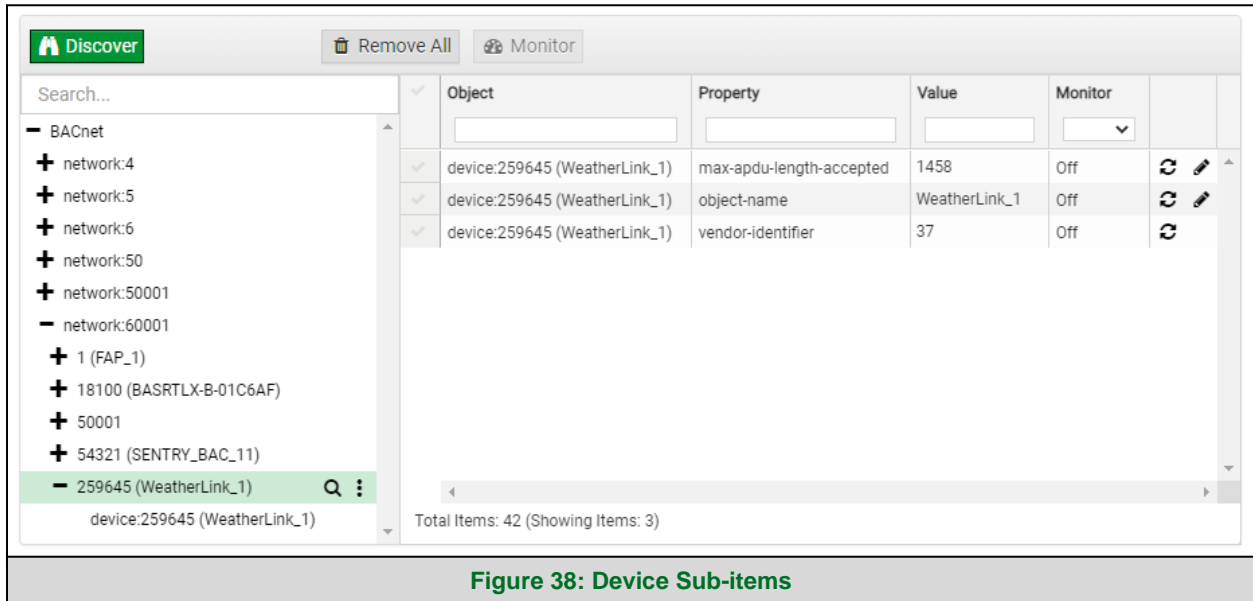

Figure 38: Device Sub-items

- To view the full details of a device, highlight the device directly (in the image below – “1991 WeatherLink\_1”) and click the Explore button (Q) that appears to the right of the highlighted device as a magnifying glass icon or double-click the highlighted device.

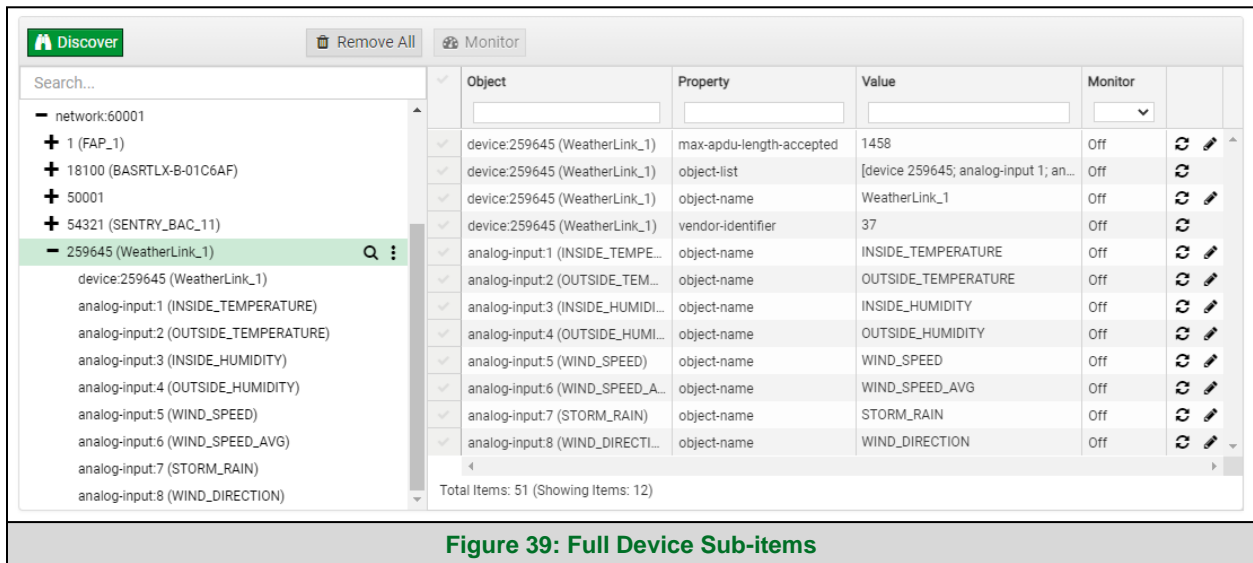

Figure 39: Full Device Sub-items

- Now additional device details are viewable; however, the device can be explored even further

- Click on one of the device details.

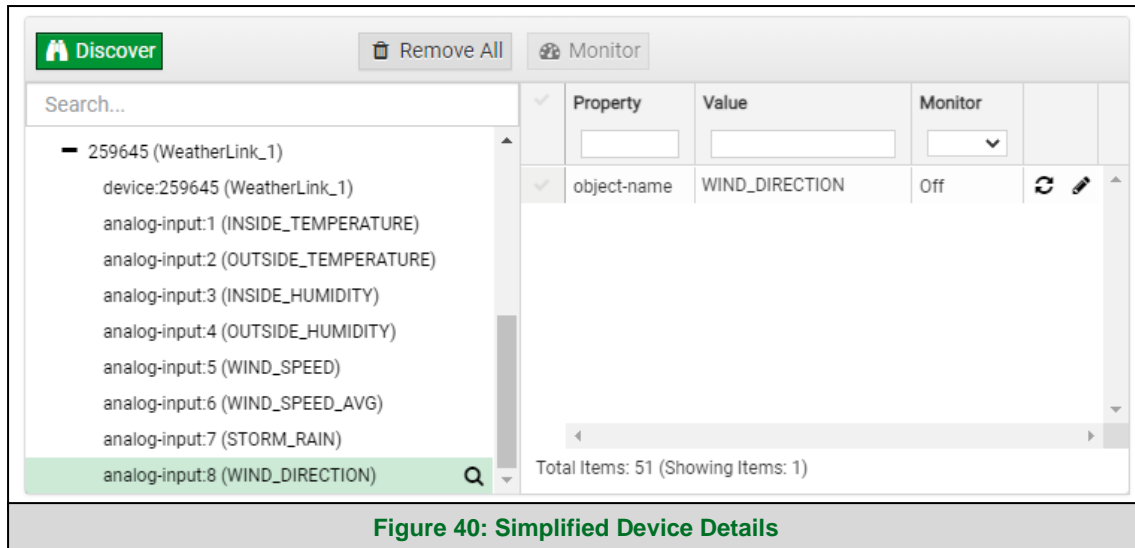

Figure 40: Simplified Device Details

- Then click on the Explore button that appears or double-click the device object.

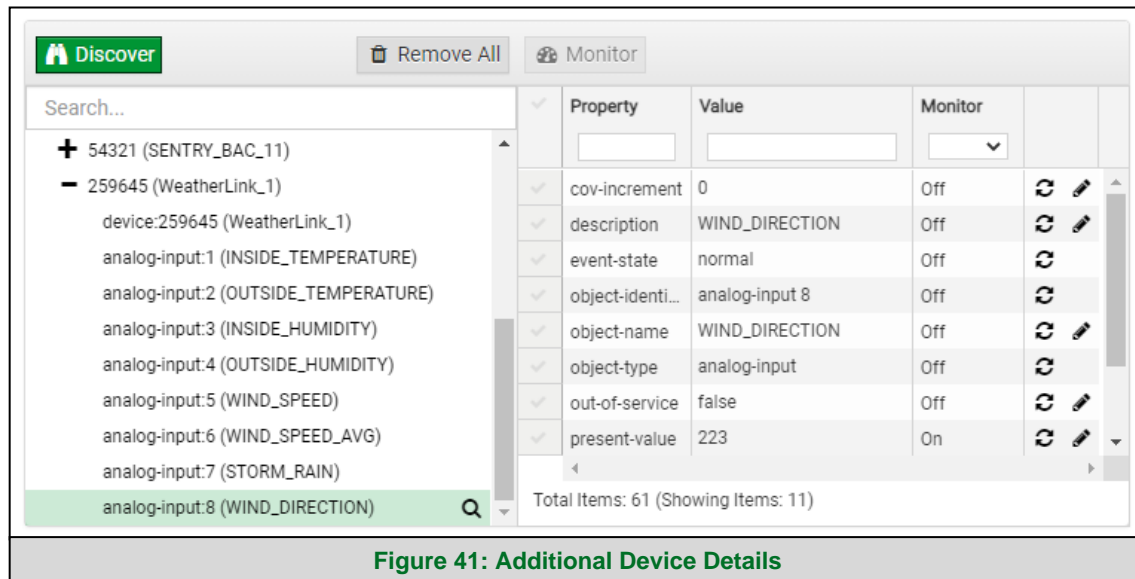

Figure 41: Additional Device Details

A full list of the device details will appear on the right side window. If changes are expected since the last explore, simply press the Refresh button (🔄) that appears to right of individual properties to refresh.

**NOTE: The Gateway Search Bar will find devices based on their Device ID.**

**NOTE: The Gateway Discovery Tree has 3 levels that correspond to the following.**

- **Network number**
  - **Device**
    - **Device object**

## 8.1.3 Explore All of a Device's Points – Deep Explore

- To explore all device objects under a specific device with one search, click the desired device to highlight it.
- Then click the three white dots (⋮) that appear to the right of the highlighted device to open a dropdown menu.

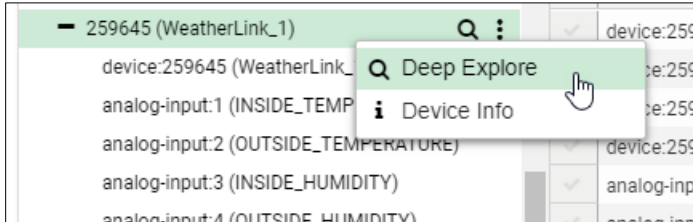

- Click Deep Explore to open the Deep Explore window.

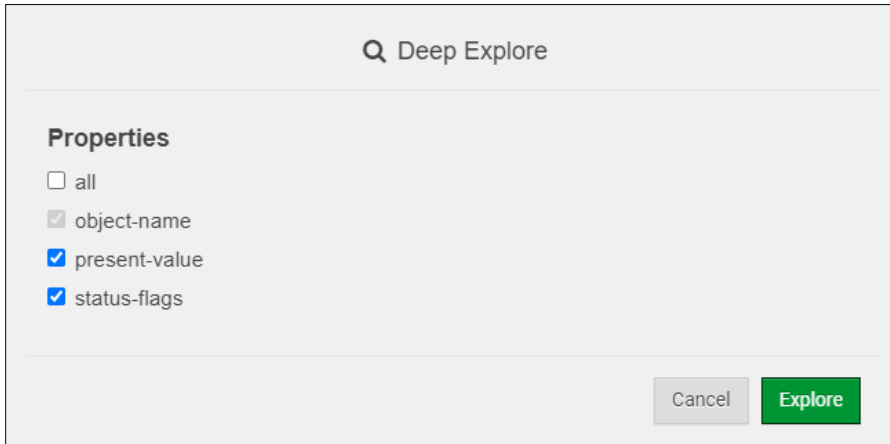

- Select which property types to find in the search.

**NOTE:** The “all” selection must be unchecked to show object-name, present-value and status-flags as options.

**NOTE:** Object-name will always be checked in a Deep Explore search.

- Click the Explore button and wait for the green explore complete message to confirm all points have been discovered.

## 8.1.4 Checking Device Information – Device Info

- To check a device's properties/information, click the desired device to highlight it.
- Then click the three white dots (  ) that appear to the right of the highlighted device to open a dropdown menu.

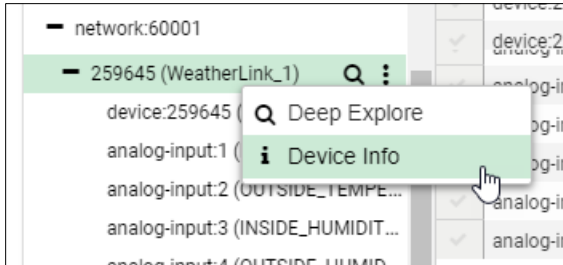

- Click Device Info to open the Device Info window and get the device information needed.

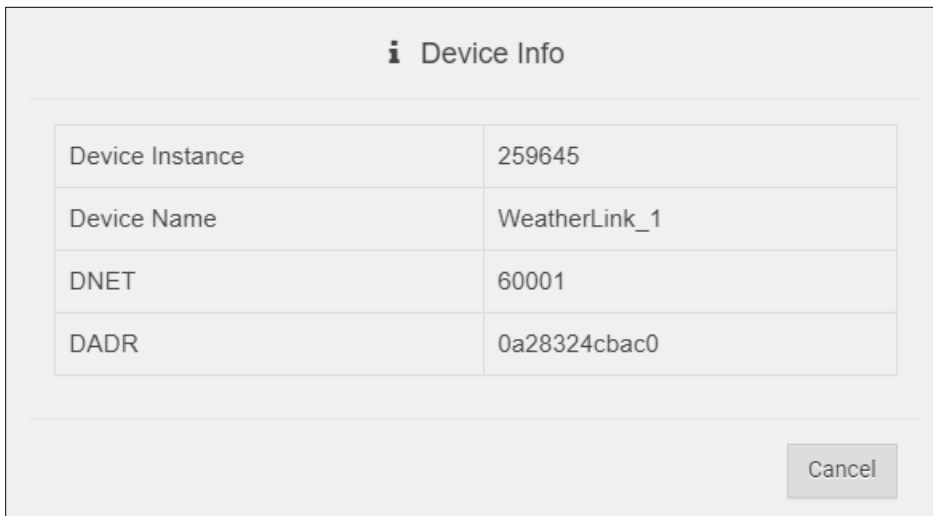

## 8.1.5 Edit the Present Value Field

The only recommended field to edit via BACnet IoT Gateway is the device's present value field.

**NOTE: Other BACnet properties are editable (such as object name, object description, etc.); however, this is not recommended because the BACnet IoT Gateway is not a Building Management System (BMS).**

- To edit the present value, select it in the property listings.

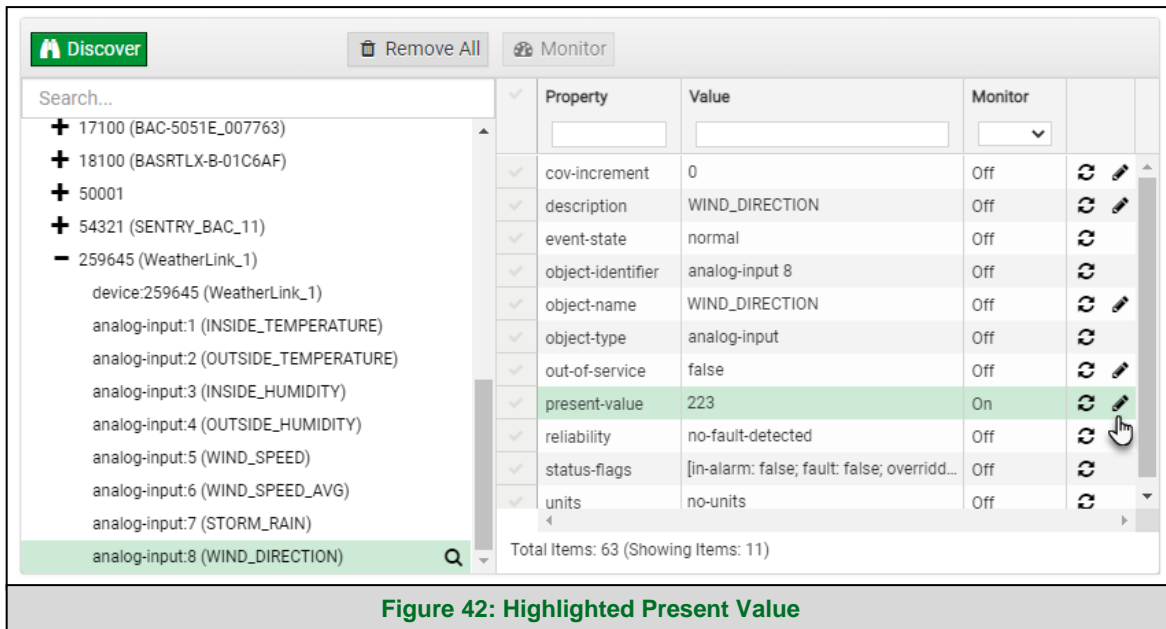



Figure 42: Highlighted Present Value

- Then click the Write button (  ) on the right of the property to bring up the Write Property window.

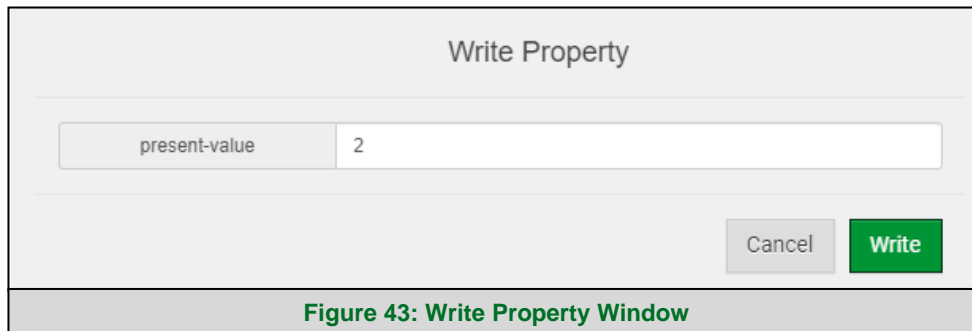

Figure 43: Write Property Window



## Using the BACnet IoT Gateway

- Enter the appropriate change and click the Write button.

The window will close. When the BACnet Explorer page appears, the present value will be changed as specified.

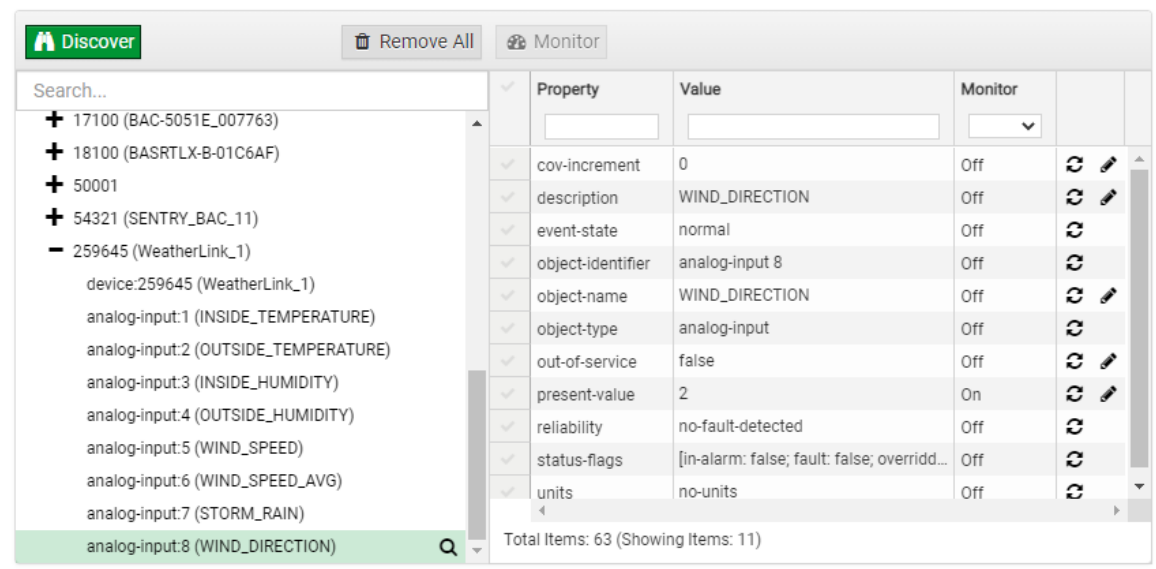

The screenshot shows the BACnet Explorer interface. On the left, a tree view lists various objects under the device '259645 (WeatherLink\_1)'. The object 'analog-input:8 (WIND\_DIRECTION)' is selected and highlighted in green. The main pane on the right displays the properties of this object in a table format. The 'present-value' property is highlighted, showing a value of '2'. The 'Monitor' column for this property is set to 'On'. Other properties include 'cov-increment' (0), 'description' (WIND\_DIRECTION), 'event-state' (normal), 'object-identifier' (analog-input 8), 'object-name' (WIND\_DIRECTION), 'object-type' (analog-input), 'out-of-service' (false), 'reliability' (no-fault-detected), 'status-flags' ([in-alarm: false; fault: false; overridd...), and 'units' (no-units). The interface also includes a search bar, 'Discover', 'Remove All', and 'Monitor' buttons.

Property	Value	Monitor		
+	17100 (BAC-5051E_007763)			
+	18100 (BASRTLX-B-01C6AF)			
+	50001			
+	54321 (SENTRY_BAC_11)			
-	259645 (WeatherLink_1)			
	device:259645 (WeatherLink_1)			
	analog-input:1 (INSIDE_TEMPERATURE)			
	analog-input:2 (OUTSIDE_TEMPERATURE)			
	analog-input:3 (INSIDE_HUMIDITY)			
	analog-input:4 (OUTSIDE_HUMIDITY)			
	analog-input:5 (WIND_SPEED)			
	analog-input:6 (WIND_SPEED_AVG)			
	analog-input:7 (STORM_RAIN)			
	analog-input:8 (WIND_DIRECTION)			
✓	Property	Value	Monitor	
✓	cov-increment	0	Off	🔄 ✎
✓	description	WIND_DIRECTION	Off	🔄 ✎
✓	event-state	normal	Off	🔄 ✎
✓	object-identifier	analog-input 8	Off	🔄 ✎
✓	object-name	WIND_DIRECTION	Off	🔄 ✎
✓	object-type	analog-input	Off	🔄 ✎
✓	out-of-service	false	Off	🔄 ✎
✓	present-value	2	On	🔄 ✎
✓	reliability	no-fault-detected	Off	🔄 ✎
✓	status-flags	[in-alarm: false; fault: false; overridd...	Off	🔄 ✎
✓	units	no-units	Off	🔄 ✎

Total Items: 63 (Showing Items: 11)

Figure 44: Updated Present Value

## 8.2 Monitor View

### 8.2.1 Set Devices to Track

Before using the Monitor View page, device properties must be selected to be monitored for analysis and testing in the BACnet Explorer page. To do so follow the instructions below:

- When viewing the expanded device properties on the BACnet Explorer page, click the checkbox to the left of any property to track.

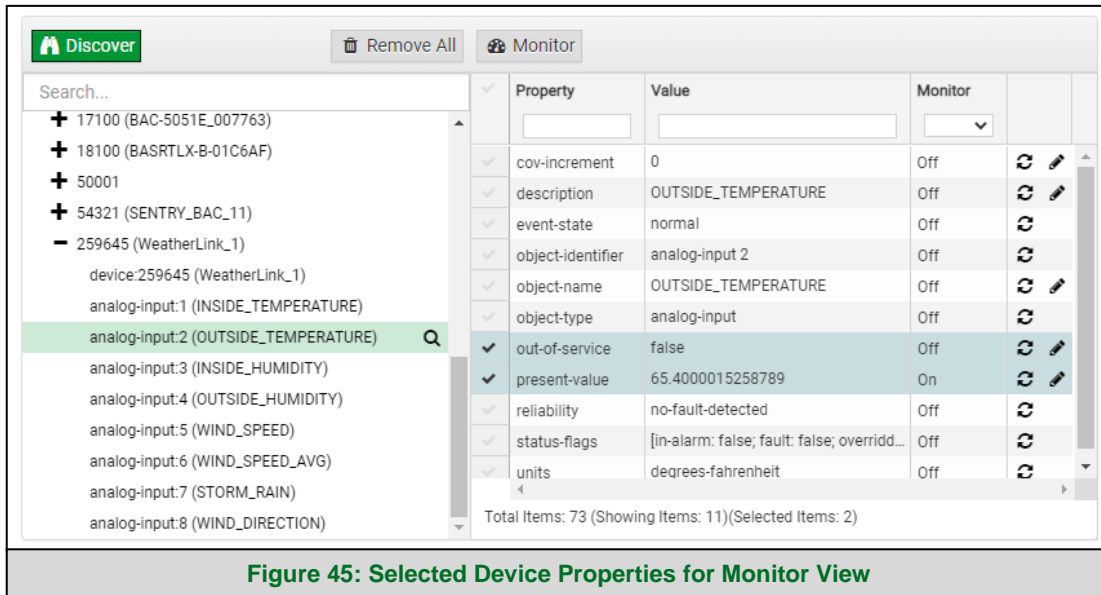

Figure 45: Selected Device Properties for Monitor View

- Once all properties are selected for that data type, click the monitor button to set the selected properties to be monitored.
  - The Monitor column in the selected property row will change from “Off” to “On”

**NOTE: A maximum of 1,000 data points can be monitored.**

- Wait for the configuration to complete, then click on the Monitor View tab.

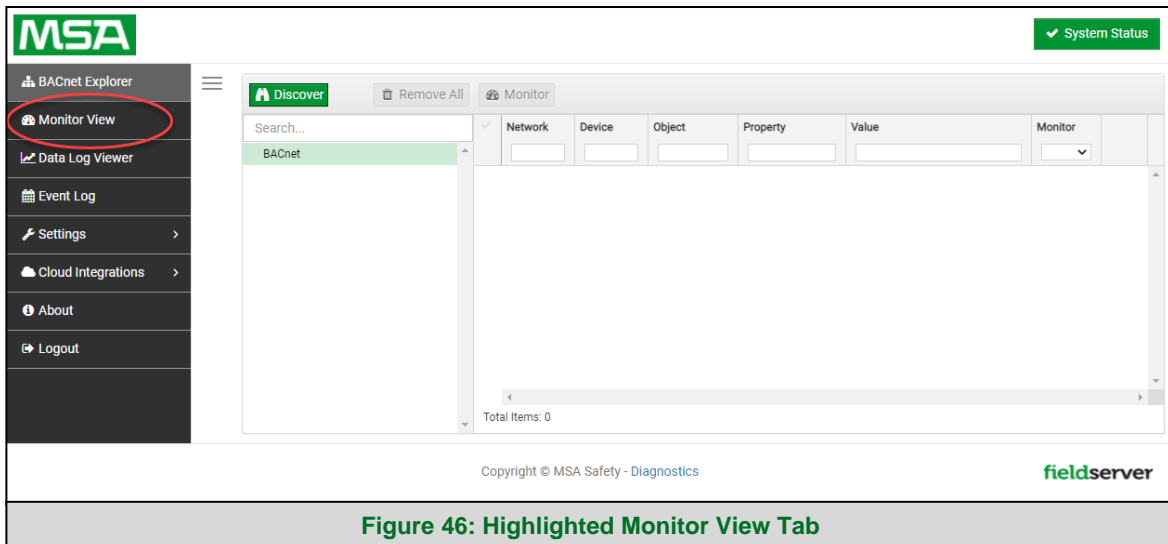

Figure 46: Highlighted Monitor View Tab

## 8.2.2 Logging Data

- For the Data Log Viewer, Event Log and the FieldServer Manager, click the checkbox under the Log column to add data points.

Status	Device	Device Name	Online	Object	Object Name	Property	Value	Last Read	Log
Normal	259645	WeatherLink_1	✓	analog-input:1	INSIDE_TEMPERATURE	present-value	73.69999694824219	10/19/21 12:21:55 PM	<input checked="" type="checkbox"/>
Normal	259645	WeatherLink_1	✓	analog-input:2	OUTSIDE_TEMPERATURE	present-value	71.0999984741211	10/19/21 12:21:55 PM	<input checked="" type="checkbox"/>
Normal	259645	WeatherLink_1	✓	analog-input:3	INSIDE_HUMIDITY	present-value	43	10/19/21 12:21:55 PM	<input checked="" type="checkbox"/>
Normal	259645	WeatherLink_1	✓	analog-input:4	OUTSIDE_HUMIDITY	present-value	39	10/19/21 12:21:55 PM	<input checked="" type="checkbox"/>
Normal	259645	WeatherLink_1	✓	analog-input:8	WIND_DIRECTION	present-value	83	10/19/21 12:21:55 PM	<input checked="" type="checkbox"/>

Total Items: 5 (Logging: 4)

**Figure 47: Monitor View Showing Tracked Device Properties**

- Click on the graph icon (📈) to the right of the data elements to open the Data Logging window.

**Log Settings**

Data Logging

Log Type: Periodic (dropdown menu open)

Logging Interval (sec):

Buttons: Cancel, Save

**Figure 48: Data Logging Window**

- Select the type of logging for the data point and set the logging interval, COV threshold value or COV max scan time as they apply then click the Save button to save the settings.

**Log Settings**

Data Logging

Log Type: Periodic

Logging Interval (sec):

Buttons: Cancel, Save

**Figure 50: Periodic Log Type**

**Log Settings**

Data Logging

Log Type: Change of value

COV Threshold Value:

COV Max Scan Time (sec):

Buttons: Cancel, Save

**Figure 49: Change of Value Log Type**

## Using the BACnet IoT Gateway

- To change the poll interval of a device, click the Settings button  (see [Figure 47](#)) to open the Settings window.

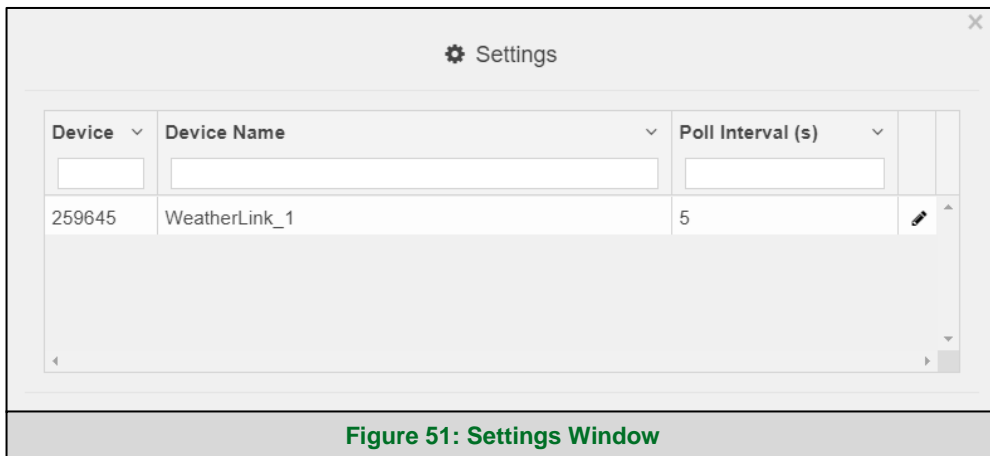

**Figure 51: Settings Window**

- Click the Edit icon to open the Edit Poll Interval window.

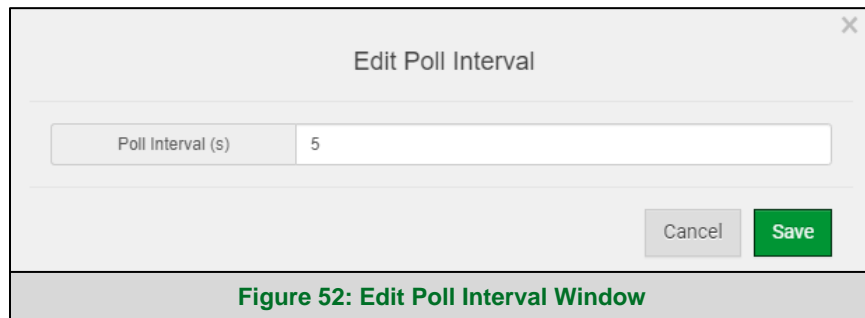

**Figure 52: Edit Poll Interval Window**

- Make desired changes and click Save.

**NOTE:** Up to 30 days of data can be recorded and stored.

**NOTE:** Click the Trash icon (  ) to the right of any logged property to remove it from Monitor View.

## 8.3 Data Log Viewer

**NOTE:** The Data Log Viewer can store up to 1,000 data points.

- Click the Data Log Viewer tab on the left side of the page.

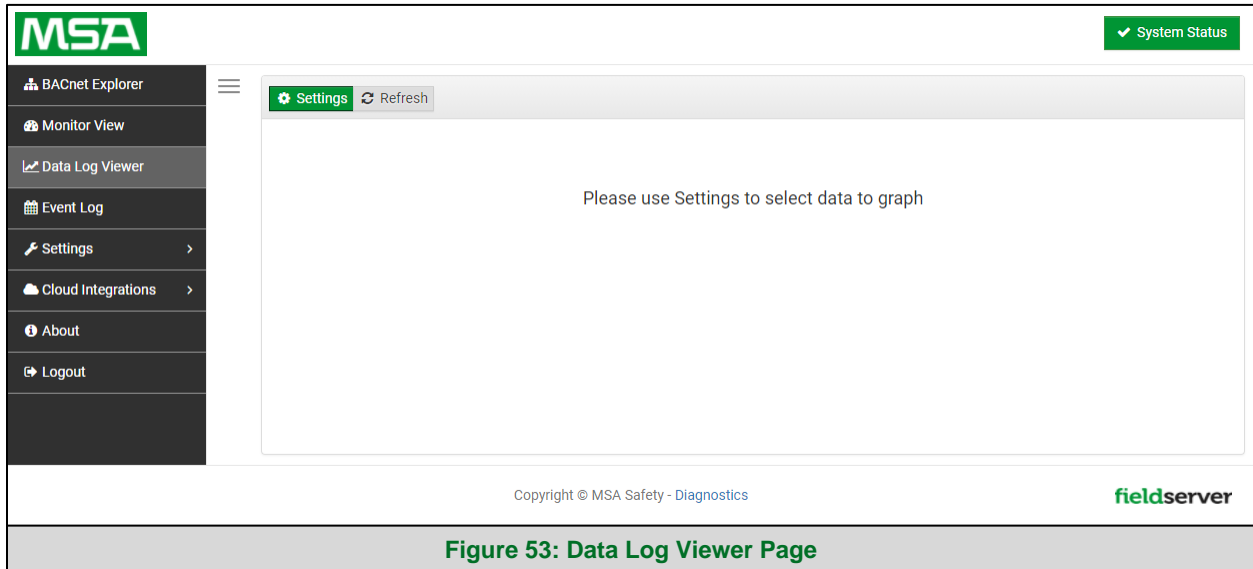

**Figure 53: Data Log Viewer Page**

### 8.3.1 Graph Data Logging Information

- Click on the Settings button (  Settings ) to select data to graph.

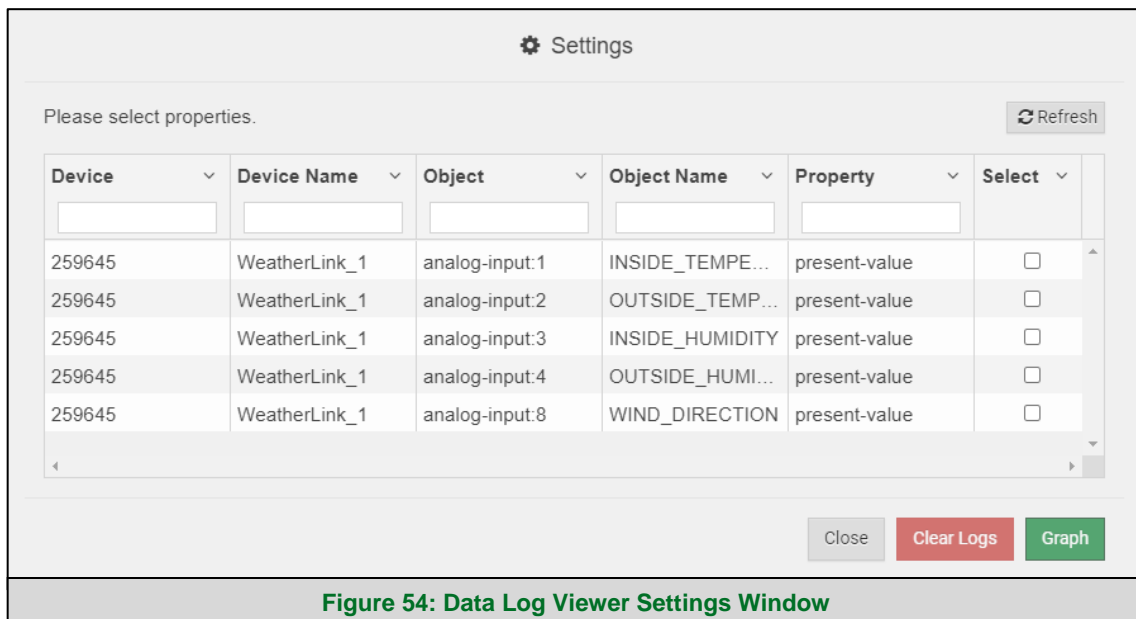

**Figure 54: Data Log Viewer Settings Window**

- Click the checkbox next to the data element to graph.
  - Any combination of elements can be selected

**NOTE:** A data element is only visible when it is set for data logging as shown in Section 8.2.

## Using the BACnet IoT Gateway

- Click Submit to generate a graph for each element selected.
  - To delete a log, check the boxes next to the properties to delete and click the Clear Logs button; then click “Yes” to confirm

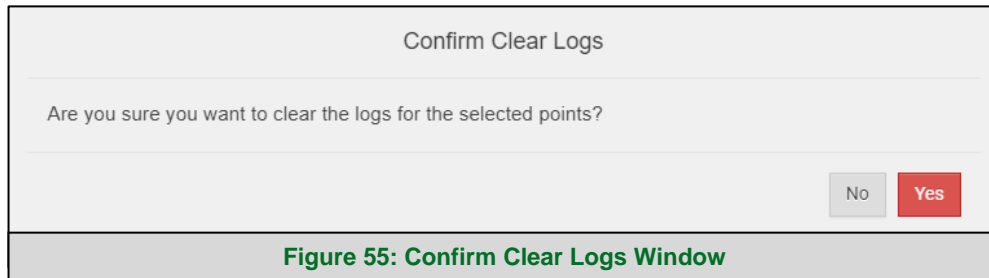

Figure 55: Confirm Clear Logs Window

- After a few seconds the graph should appear.

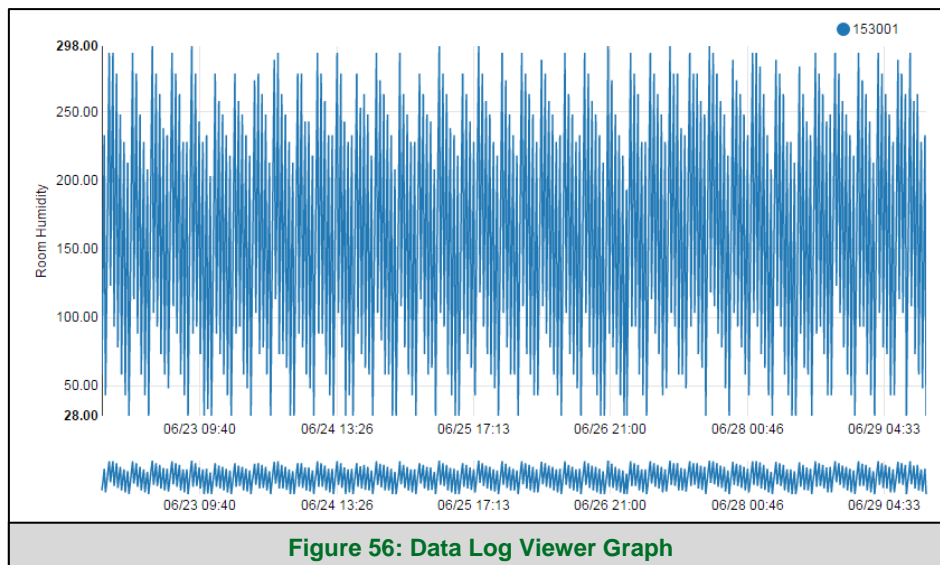
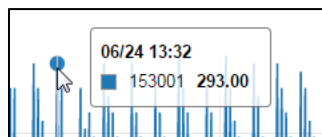
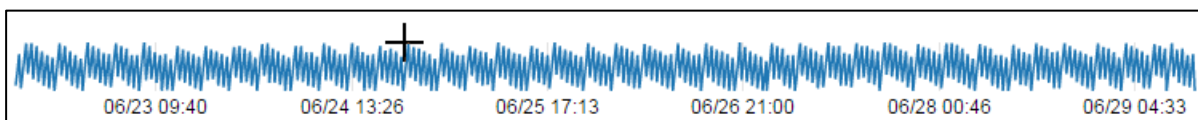

Figure 56: Data Log Viewer Graph

**To view individual values of data**, scroll across the graph to show a text box that states each exact point and the location of that point on the graph via a blue dot.



**To view a graph of only select dates/time frames**, move the cursor towards the miniature version of the graph that is shown just below the full size graph. Hover the cursor over the miniature graph so that the cursor becomes a crosshair ( + ).



Click and hold near the beginning or ending time frame desired, then drag the crosshair towards the ending or beginning time frame; all within the confines of the miniature graph.

The full-size version of the graph will populate accordingly.

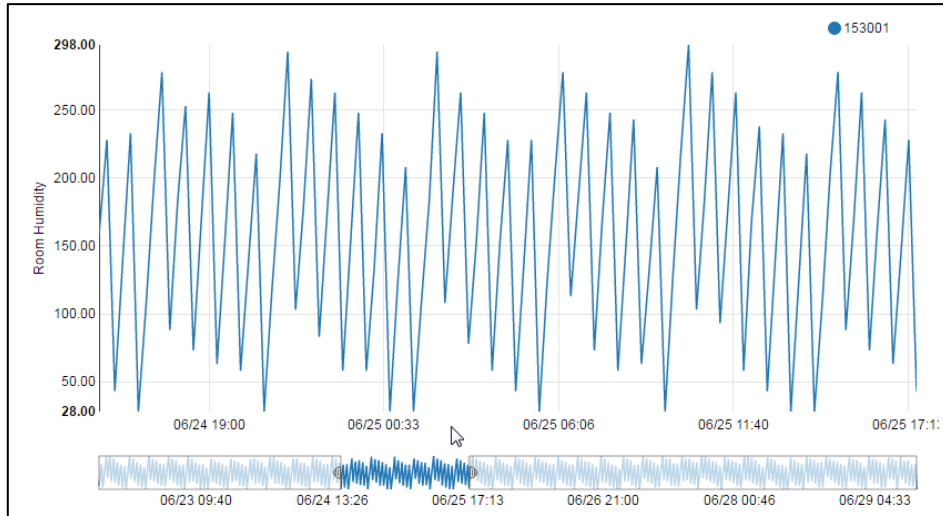

**Figure 57: Selected Portion of Data Log Viewer Graph**

Any additional edits to the time frame can be adjusted by clicking and dragging the wedge markers on either side of the highlighted portion of the miniature graph.

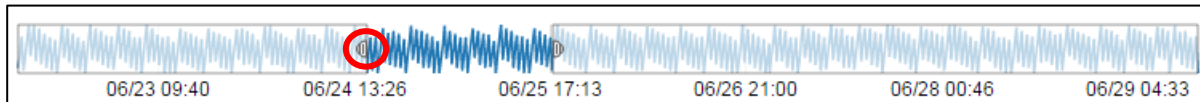

To go back to the full graph, click on any faded portion of the miniature graph.

**NOTE: The data selected in the Data Log Viewer is also available via the RESTful API, contact FieldServer Technical Support for a copy of the RESTful API Start-up Guide.**

## 8.3.2 Creating an Event Log

- To create an event log for a property, click on the Monitor View tab to go to the Monitor View page.

Status	Device	Device Name	Online	Object	Object Name	Property	Value	Last Read	Log
Normal	259645	WeatherLink_1	✓	analog-input:1	INSIDE_TEMPERATURE	present-value	73.29999542236328	10/19/21 12:19:05 PM	<input checked="" type="checkbox"/>
Normal	259645	WeatherLink_1	✓	analog-input:2	OUTSIDE_TEMPERATURE	present-value	70.79999542236328	10/19/21 12:19:05 PM	<input checked="" type="checkbox"/>
Normal	259645	WeatherLink_1	✓	analog-input:3	INSIDE_HUMIDITY	present-value	43	10/19/21 12:19:05 PM	<input checked="" type="checkbox"/>
Normal	259645	WeatherLink_1	✓	analog-input:4	OUTSIDE_HUMIDITY	present-value	39	10/19/21 12:19:05 PM	<input checked="" type="checkbox"/>
Normal	259645	WeatherLink_1	✓	analog-input:8	WIND_DIRECTION	present-value	83	10/19/21 12:19:05 PM	<input checked="" type="checkbox"/>

Total Items: 5 (Logging: 5)

**Figure 58: Monitor View Device Properties**

- Click the bell icon (🔔) to the right of the property to log and the Event Settings window will open.

**Figure 59: Event Settings Window**

- Click on the Add Event button to change the event settings.

**Figure 60: Add Event Settings**

- Set the event as needed and click Save.



# Using the BACnet IoT Gateway

- Repeat this process to create more events as needed.

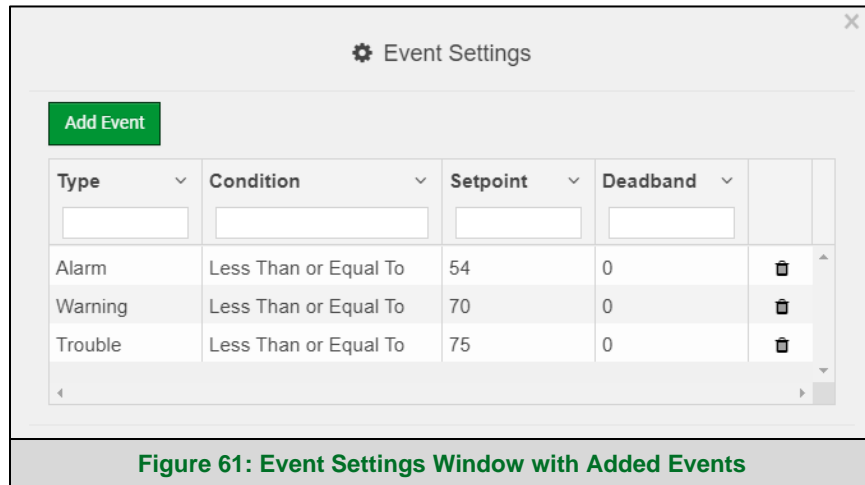

Figure 61: Event Settings Window with Added Events

**NOTE:** Click the Trash icon (🗑️) to the right of any event to remove it.

- Click the "x" in the top right corner of the Event Settings window to close it.
  - The Monitor View page will now update the status column as events take place

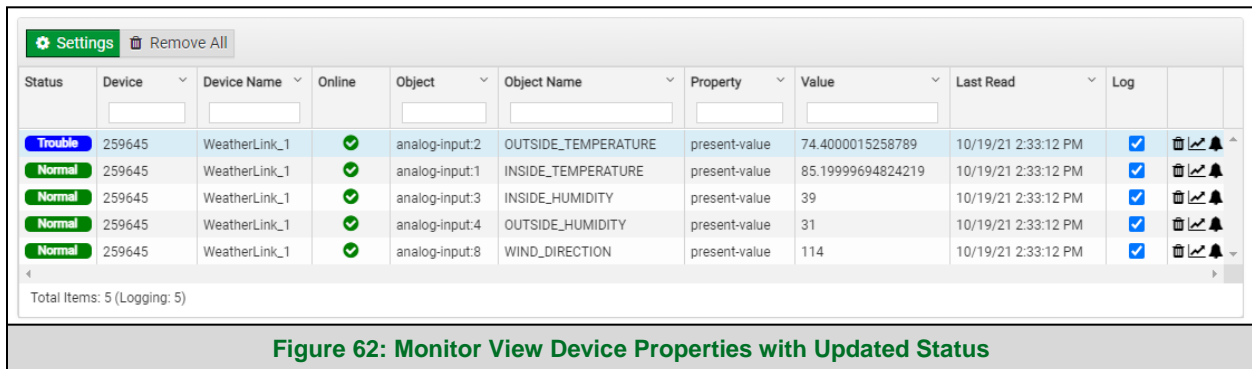

Figure 62: Monitor View Device Properties with Updated Status

## 8.4 Event Log

Click the Event Log tab on the left side of the page to open the Event Logger and view the events that have been set to track in **Section 8.3.2** (by time and type with a descriptive message).

The screenshot shows the MSA BACnet IoT Gateway interface. On the left is a navigation menu with options: BACnet Explorer, Monitor View, Data Log Viewer, Event Log (selected), Settings, Cloud Integrations, About, and Logout. The main area displays an event log table with the following data:

Time	Type	Message
Oct 19, 2021 2:40:39 PM	Point Status	WeatherLink_1 (259645) - OUTSIDE_TEMPERATURE (analog-input:2) - present-value is 74.19999694824219 (Event removed). ...
Oct 19, 2021 2:32:40 PM	Point Status	WeatherLink_1 (259645) - OUTSIDE_TEMPERATURE (analog-input:2) - present-value is 74.5 (<= 75). Normal to Trouble.
Oct 19, 2021 2:32:09 PM	Point Status	WeatherLink_1 (259645) - OUTSIDE_TEMPERATURE (analog-input:2) - present-value is 74.5 (Event removed). Warning to Norm...
Oct 19, 2021 2:31:52 PM	Point Status	WeatherLink_1 (259645) - OUTSIDE_TEMPERATURE (analog-input:2) - present-value is 74.5 (<= 75). Normal to Warning.
Aug 10, 2021 10:35:42 AM	Point Status	WeatherLink_1 (1992) - OUTSIDE_HUMIDITY (analog-input:4) - present-value is 51 (Event removed). Alarm to Normal.
Aug 10, 2021 10:35:18 AM	Point Status	WeatherLink_1 (1992) - OUTSIDE_HUMIDITY (analog-input:4) - present-value is 51 (< 60). Normal to Alarm.
Feb 4, 2021 2:45:55 AM	Point Status	1991/analog-input:1/present-value, Event removed: Alarm to Normal
Feb 4, 2021 2:45:38 AM	Point Status	1991/analog-input:1/present-value; >= 50: Normal to Alarm
Feb 4, 2021 2:44:19 AM	Point Status	1991/analog-input:1/present-value; Event removed: Alarm to Normal
Feb 4, 2021 2:42:39 AM	Point Status	1991/analog-input:1/present-value; >= 50: Normal to Alarm

At the bottom of the table is a 'Clear Event Log' button. The footer of the page includes 'Copyright © MSA Safety - Diagnostics' and the 'fieldserver' logo.

**Figure 63: Event Log Page Showing Added Events**

## 9 FieldServer Manager Setup

The Grid is MSA Safety’s device cloud solution for IIoT. Integration with the MSA Grid – FieldServer Manager enables a secure remote connection to field devices through a FieldServer and hosts local applications for device configuration, management, as well as maintenance. For more information about the FieldServer Manger, refer to the [MSA Grid - FieldServer Manager Start-up Guide](#).

### 9.1 Create a New FieldServer Manager Account

The first step to connecting to the FieldServer Manager is to create an account.

- Click on the Cloud Integrations tab, then click the FieldServer Manager tab.

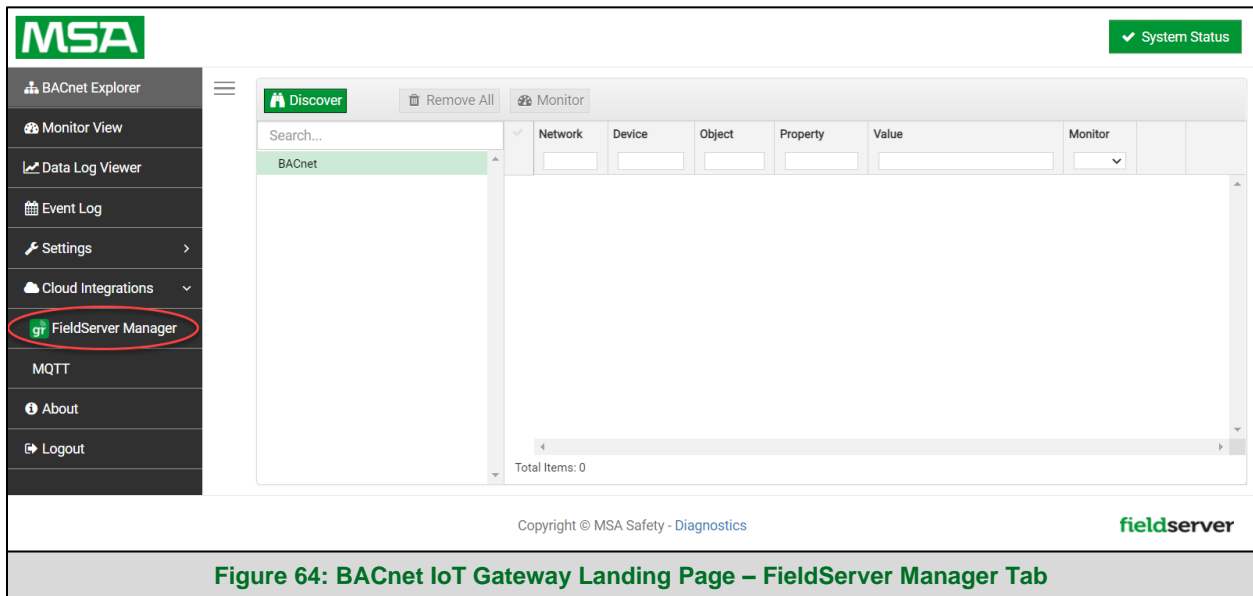

Figure 64: BACnet IoT Gateway Landing Page – FieldServer Manager Tab

- An informational splash page will appear, click the Close button to view the registration page.

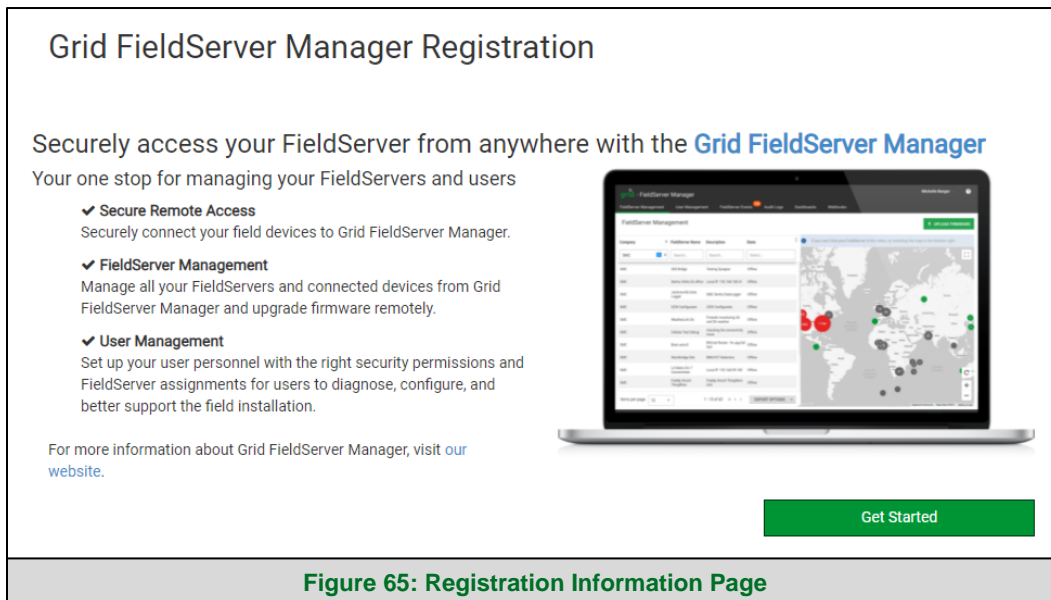
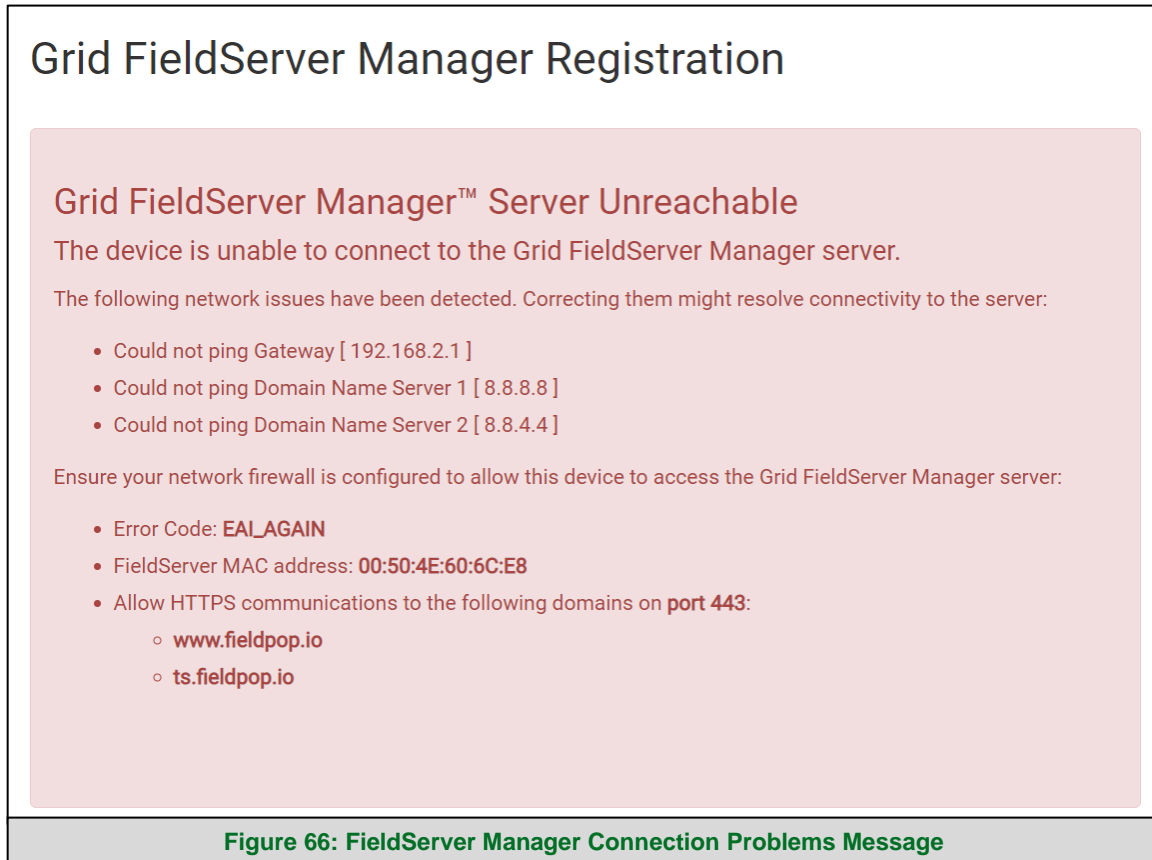

Figure 65: Registration Information Page

- If a warning message appears instead of the splash page, follow the suggestion that appears on screen.
- If the BACnet IoT Gateway cannot reach the Grid server, the following message will appear.



- Follow the directions presented in the warning message and check that the DNS settings are set up with the following Domain Name Server (DNS) settings:

DNS1=8.8.8.8

DNS2=8.8.4.4

- Ensure that the BACnet IoT Gateway is properly connected to the Internet

**NOTE:** If changes to the network settings are done, remember to save and then power cycle the BACnet IoT Gateway to update the settings.

# FieldServer Manager Setup

- Fill in the user details, site details, gateway details and create a new account.
  - Enter user details and click Next

The screenshot shows the 'Installer Details' step of the registration process. At the top, there are four numbered steps: 1 (Installer Details), 2 (Installation Site), 3 (FieldServer Details), and 4 (Account Details). The 'Installer Details' section includes the following fields: 'Installer Name', 'Company', 'Telephone', 'Email', and 'Installation Date' (pre-filled with '20-September-2021'). At the bottom right, there are 'Cancel' and 'Next' buttons.

Figure 67: FieldServer Manager Registration – Installer Details

- Enter the site details by entering the physical address fields or the latitude and longitude then click Next

The screenshot shows the 'Installation Site Details' step of the registration process. At the top, there are four numbered steps: 1 (Installer Details), 2 (Installation Site), 3 (FieldServer Details), and 4 (Account Details). The 'Installation Site Details' section includes a search bar for Google Maps, and the following fields: 'Site Name', 'Building', 'Street Address', 'Suburb', 'City', 'State', 'Country', 'Postal Code', 'Latitude', and 'Longitude'. The 'Site Name', 'Latitude', and 'Longitude' fields are highlighted in red. To the right of the form is a Google Maps interface showing a map of the Lafayette area. At the bottom right, there are 'Cancel', 'Previous', and 'Next' buttons.

Figure 68: FieldServer Manager Registration – Site Details

- Enter Name and Description (required) then click Next

**Grid FieldServer Manager Registration**

1 Installer Details    2 Installation Site    3 FieldServer Details    4 Account Details

**FieldServer Details**

Name

Description

FieldServer Info   
Optionally specify any other information relating to the FieldServer i.e., calibration, commissioning or other notes

Timezone (GMT-08:00) America/Los\_Angeles

Cancel Previous Next

**Figure 69: FieldServer Manager Registration – Gateway Details**

- Click the “Create an Grid FieldServer Manager account” button and enter a valid email to send a “Welcome to FieldServer Manager” invite to the email address entered

**Grid FieldServer Manager Registration**

1 Installer Details    2 Installation Site    3 FieldServer Details    4 Account Details

**New Users**

If you do not have Grid FieldServer Manager credentials, you can create a new Grid FieldServer Manager account now [Create an Grid FieldServer Manager account](#)

**Existing Users - Enter FieldServer registration details**

**User Credentials**

Username

Password

Cancel Previous Register FieldServer

**Figure 70: FieldServer Manager Registration – Account**

- Once the device has successfully been registered, a confirmation window will appear. Click the Close button and the following screen will appear listing the device details and additional information auto-populated by the BACnet IoT Gateway.

## Grid FieldServer Manager Registration

### FieldServer Registered

<b>FieldServer Details</b> <b>Name:</b> Test1 <b>Description:</b> FS Test <b>FieldServer Info:</b> <b>Timezone:</b> America/Los_Angeles <b>MAC Address:</b> 00:50:4E:60:13:FE <b>Tunnel Server URL:</b> tunnel.fieldpop.io <b>FieldServer ID:</b> treedancer_KrgPKmLRY <b>Product Name:</b> Core Application - Default <b>Product Version:</b> 5.2.0	<b>Installer Details</b> <b>Installer Name:</b> Test <b>Company:</b> MSA Safety <b>Telephone:</b> (408) 444-4444 <b>Email:</b> contactus@msasafety.com <b>Installation Date:</b> Sep 20, 2021	<b>Installation Site Details</b> <b>Site Name:</b> Site#1 <b>Building:</b> <b>Street Address:</b> 1020 Canal Road <b>Suburb:</b> <b>City:</b> Lafayette <b>State:</b> Indiana <b>Country:</b> United States <b>Postal Code:</b> 47904
---	--	---

[Update FieldServer Details](#)

**Figure 71: Device Registered for the FieldServer Manager**

**NOTE:** Update these details at any time by going to the FieldServer Manager tab and clicking the Update FieldServer Details button.

# FieldServer Manager Setup

- Open the registered email account.
- The “Welcome to FieldServer Manager” email will appear as shown below.

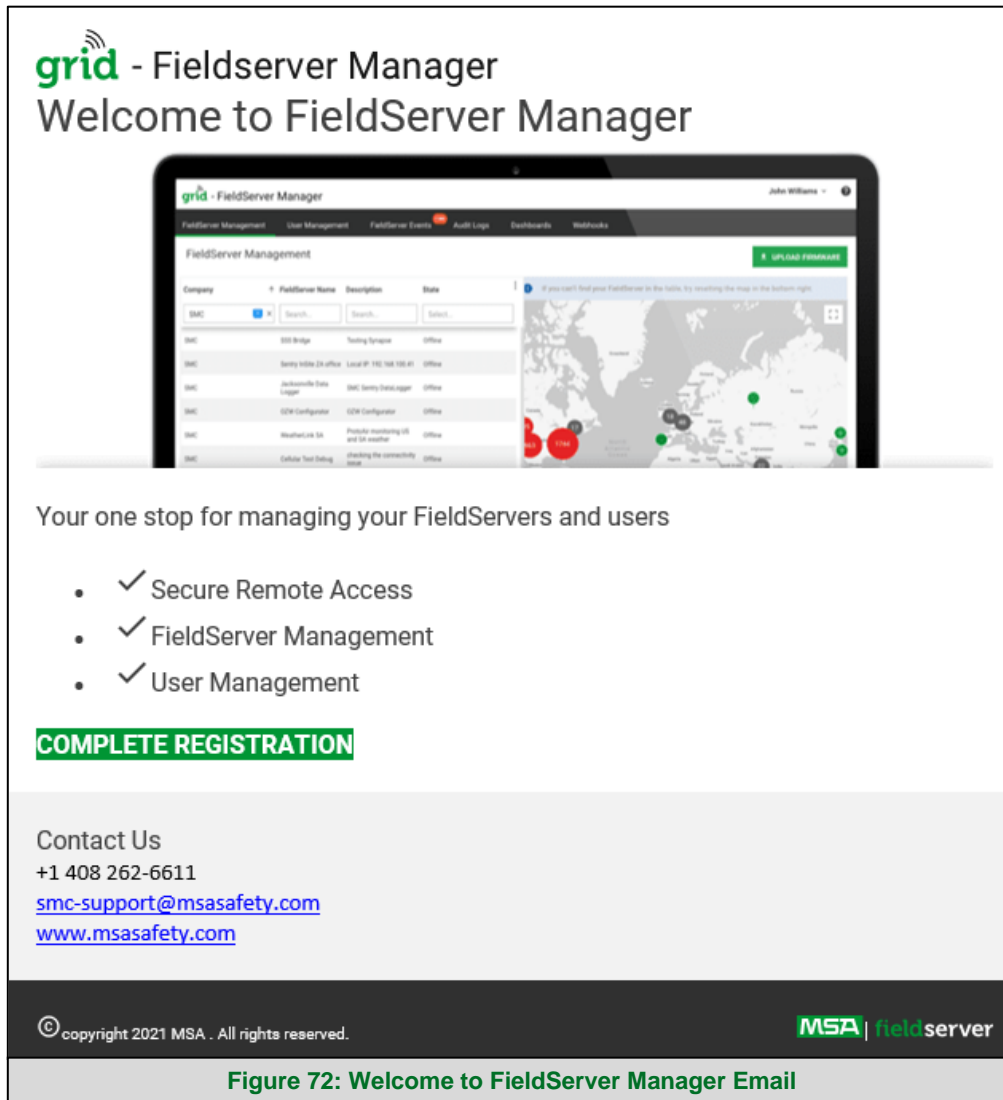

Figure 72: Welcome to FieldServer Manager Email

**NOTE:** If no email was received, check the spam/junk folder for an email from [notification@fieldpop.io](mailto:notification@fieldpop.io). Contact the FieldServer support team if the email cannot be found.



## FieldServer Manager Setup

- Click the “Complete Registration” button and fill in user details accordingly.

**Complete Your Registration**

Email Address  
user@gmail.com

First Name \*

Last Name \*

Mobile Phone Number \*

(201) 555-0123 \*Invalid Mobile Number

New Password \*

password

Confirm Password \*

password

\* Please enter new password

By registering my account with MSA, I understand that I am agreeing to the FieldServer Manager [Terms of Service and Privacy Policy](#) \*

\* Mandatory Fields

Cancel Save

**Figure 73: Setting User Details**

- Fill in the name, phone number, password fields and click the checkbox to agree to the privacy policy and terms of service.

**NOTE:** If access to data logs using RESTful API is needed, do not include “#” in the password.

- Click “Save” to save the user details.
- Click “OK” when the Success message appears.
- Record the email account used and password for future use.

## 9.2 Login to the FieldServer Manager

After the BACnet IoT Gateway is registered, go to [www.smccloud.net](http://www.smccloud.net) and type in the appropriate login information as per registration credentials.

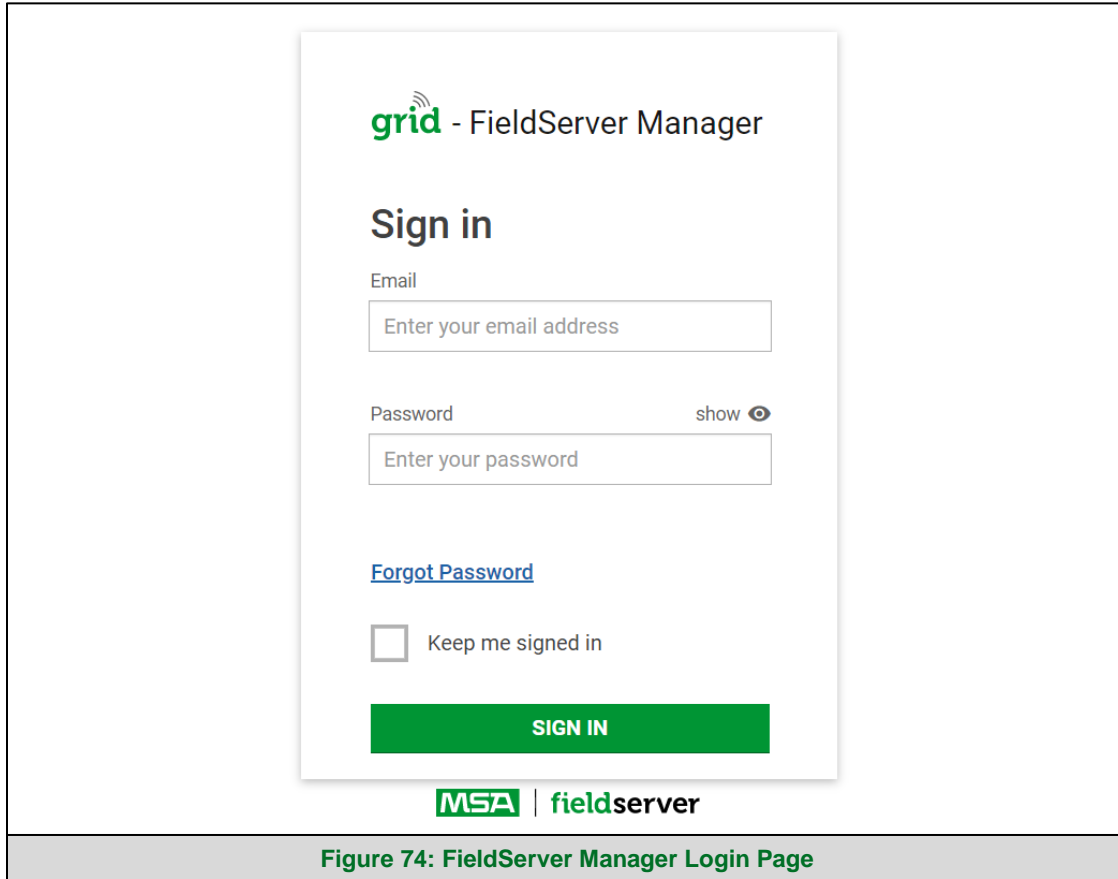

Figure 74: FieldServer Manager Login Page

**NOTE:** If the login password is lost, see the [MSA Grid - FieldServer Manager Start-up Guide](#) for recovery instructions.

**NOTE:** For additional Grid instructions see the [MSA Grid - FieldServer Manager Start-up Guide](#).

The screenshot displays the 'FieldServer Manager' interface. At the top, there is a navigation bar with the 'grid' logo and the text 'FieldServer Manager'. Below this, a secondary navigation bar contains links for 'FieldServer Management', 'User Management', 'FieldServer Events', 'Audit Logs', 'Dashboards', and 'Webhooks'. The main content area is titled 'FieldServer Management' and features a green 'UPLOAD FIRMWARE' button. On the left, a table lists various FieldServers with columns for Company, FieldServer Name, Description, and State. On the right, a world map shows the geographical distribution of these devices, with circular markers and numbers indicating device counts in different regions. A footer at the bottom contains copyright information for MSA and the 'MSA | fieldserver' logo.

Company	FieldServer Name	Description	State
Eggers OEM	Jens's Brain 31	192.168.1.31	Offline
Eggers OEM	Jens MBP Core App	~/git/smc-core-application	Offline
Eggers OEM	Jens's Dell Profile View	~/git/profile-view	Offline
Eggers OEM	hd_test_log_to_fpop	testing_modbus	Offline
Eggers OEM	Mbus demo	testing registration	Offline
SMC	TestWall-PA2port 97	Testwall pa 2 97	Offline
SMC	TestWall-Lon152	Testwall unit	Offline

**Figure 75: FieldServer Manager Landing Page**

## 10 MQTT Integration

### 10.1 MQTT Published Messages

The BACnet IoT Gateway uses a single connection to the Broker URL. Communication via MQTT is “topic” based, meaning each data point is defined via an arbitrarily long and unique “topic” string which is usually in the following format: [(unique gateway identifier)/(unique node identifier)/(unique data point identifier)].

These topics are published via the logging method that was set up for the data points in Monitor View. Refer to **Section 8.2** and **Section 8.3** for logging instructions.

The payload for each topic is in JSON format, containing the properties ‘value’ and ‘timestamp’.

**NOTE:** For message structure information see the [MQTT Message Structure ENOTE](#) on the [MSA Safety website](#).

## 10.2 Connect to MQTT

- After setup and initial configuration of the BACnet IoT Gateway is complete, click the Cloud Integrations tab.
- Then click the MQTT tab.

The screenshot displays the MSA FieldServer Manager web interface. On the left is a dark sidebar with navigation options: BACnet Explorer, Monitor View, Data Log Viewer, Event Log, Settings, Cloud Integrations, FieldServer Manager, MQTT, About, and Logout. The main content area is titled 'Connection Settings' and contains an 'Authentication Details' section. This section has three input fields: 'Broker URL' (which is currently red and has an error message 'Invalid value : Enter a valid Broker URL'), 'Username', and 'Password'. At the bottom right of this section are 'Clear' and 'Save' buttons. Below the settings is a 'Status' section. The footer of the page includes the copyright notice 'Copyright © MSA Safety - Diagnostics' and the 'fieldserver' logo.

- Enter Authentication Details gathered from the MQTT Platform into the Connection Settings Window.
- Click Save to record the information and allow MQTT integration to your account.

## 10.3 Check the Status Window

- Scroll down from the Settings Window until the Status Window is visible.

**Status** ▼

---

**Connection Status**

Connection to MQTT Broker
Connected to server at 9:03 AM, June 3

success

---

**MQTT Publish Topics**

All gateway data are published under "stickycowl\_Jv4gw-Ny4/#"

---

**Communication Stats**

Type	Success	Error	Last Updated	Status
Authentication	0	0	31-10-2018 02:48:08	<span style="background-color: #28a745; color: white; padding: 2px 5px; font-size: 0.8em;">success</span>
Outgoing Messages	0	0	31-10-2018 02:48:08	<span style="background-color: #28a745; color: white; padding: 2px 5px; font-size: 0.8em;">success</span>
Incoming Messages	0	0	31-10-2018 02:48:08	<span style="background-color: #28a745; color: white; padding: 2px 5px; font-size: 0.8em;">success</span>

---

**Device List Summary**

Device Instance	Last Updated
31	31-10-2018 02:48:08

- The Connection Status Section shows the state of connection to the MQTT Broker with the date and time of connection listed.
- The Communication Stats Section lists the communication statistics of the connected devices.
- The Device List Summary lists the device instances and the last time they were updated.

## 11 OpenVPN Setup

### 11.1 Setup Amazon AWS Server

It is recommended to use OpenVPN with Amazon AWS. Follow the linked guide to setup an Amazon AWS server: <https://openvpn.net/amazon-cloud/>

There are 2 options for running OpenVPN on Amazon:

- Purchase the license through Amazon and only pay for the time the OpenVPN is running. For a 5 device license the pricing is listed below:  
**Starting from \$0.07/hr or from \$490.00/yr (20% savings) for software + AWS usage fees**
- Bring your own License (BYOL): Amazon offers an unlicensed version of the EC2 instance. A license can be purchased from OpenVPN and entered into the instance. This option is cheaper for continuous usage.

11.2 Setup OpenVPN Cloud

11.2.1 Configure the OpenVPN Server

- Once the AWS server is configured, enter the server's IP Address/admin into the local device's web browser. Example: 35.163.72.29/admin
- This may generate a security warning as there is no certificate for HTTPS to verify. Click the Advanced button to proceed to the IP Address (unsafe). A domain with DNS entry can resolve this error.

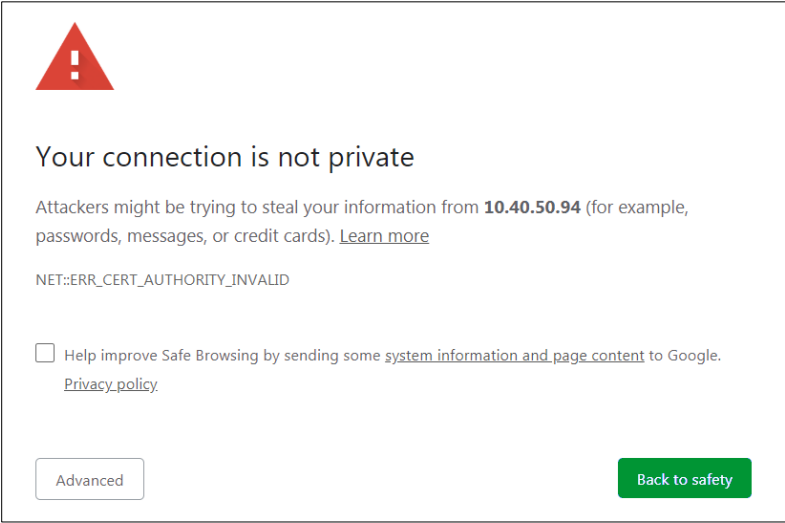

**NOTE:** Some browsers may require adding the IP Address to the trusted IP sites list.

11.2.2 Login to the Server

- Once on the website, use Admin credentials to login.

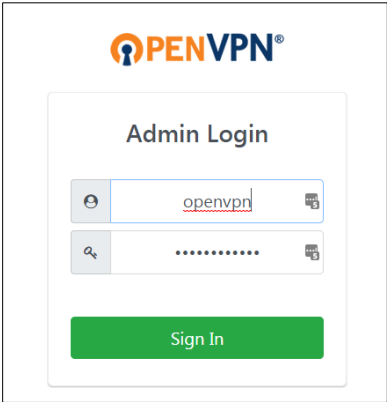



11.2.3 Create a New User for the PC Connection

- Find the User Management Section in the Navigation bar on the left side of the screen.
- Click on User Permissions.

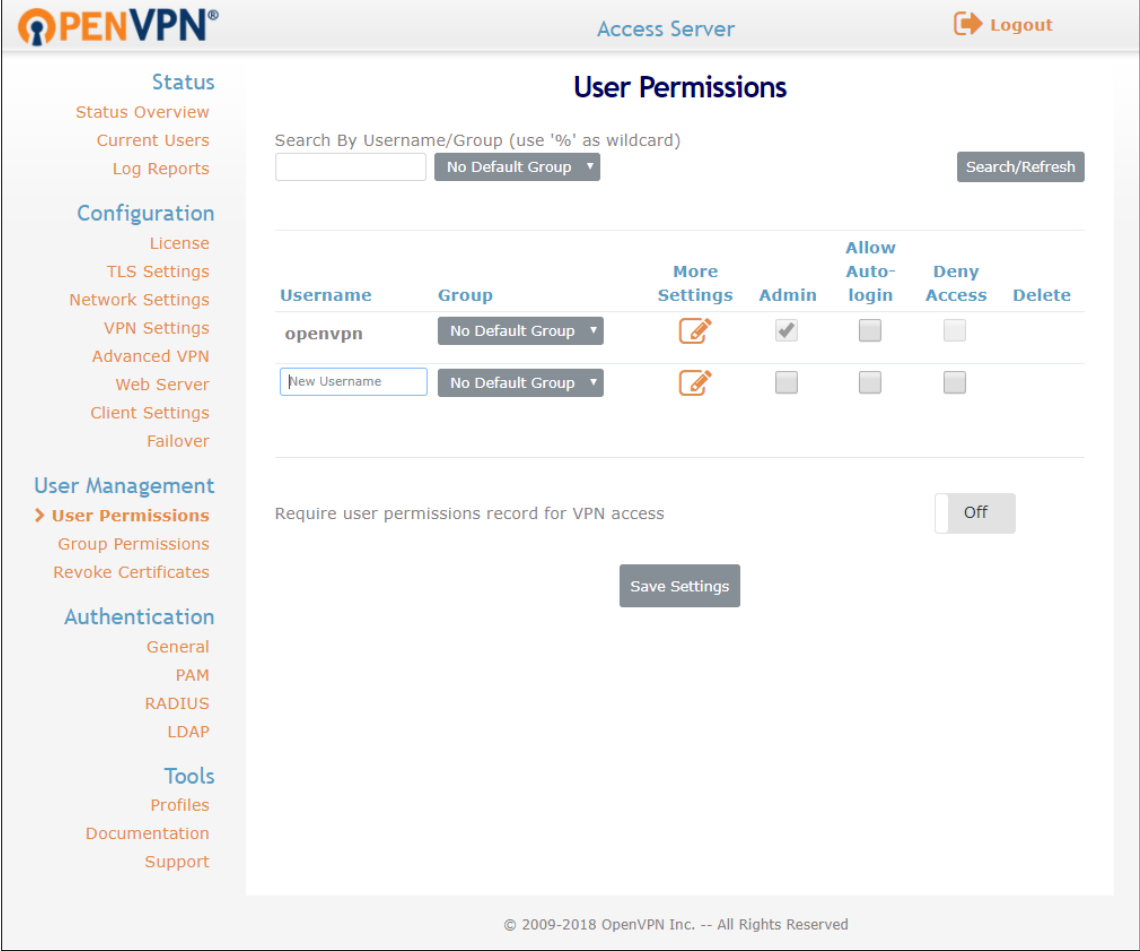

- Once the User Permissions page is open, type in a new username in the text field under the Username heading and make sure the Admin, Allow-Auto login, and Deny Access boxes are all unchecked.

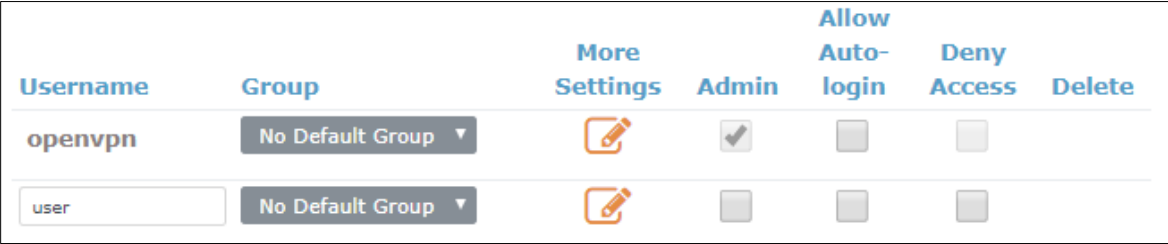

- Click the configuration button (edit icon) under the More Settings heading to access more configuration options.

- Enter a password for the USER profile in the Local Password field and record for future use.

Username	Group	More Settings	Admin	Allow Auto-login	Deny Access	Delete
openvpn	No Default Group		<input checked="" type="checkbox"/>	<input type="checkbox"/>	<input type="checkbox"/>	
user	No Default Group		<input type="checkbox"/>	<input type="checkbox"/>	<input type="checkbox"/>	

Local Password:

Select IP Addressing:  Use Dynamic  Use Static

**Access Control**

Select addressing method:  Use NAT  Use routing

Allow **Access To** these Networks:

Allow **Access From**:  all server-side private subnets

Allow **Access From**:  all other VPN clients

**VPN Gateway**

Configure VPN Gateway:  No  Yes

**DMZ settings**

Configure DMZ IP address:  No  Yes

Require user permissions record for VPN access  Off

- Once configuration is complete, click the Save Settings button and then click the Update Running Server button.

**User Permissions Changed**  
User 'user' added.  
Default permissions changed (default set to Allow access).  
Press the button below to propagate the changes to the running server.

**Running Server Updated**  
The relevant components of the server have been restarted to activate the changes made to the active profile

11.2.4 Create a New User for the Device Connection

- Once the User Permissions page is open, type in a new device name in the text field under the Username heading and make sure the Allow-Auto login box is checked, and the Admin and Deny Access boxes are all unchecked.

Username	Group	More Settings	Admin	Allow Auto-login	Deny Access	Delete
openvpn	No Default Group		<input checked="" type="checkbox"/>	<input type="checkbox"/>	<input type="checkbox"/>	
user	No Default Group		<input type="checkbox"/>	<input type="checkbox"/>	<input type="checkbox"/>	<input type="checkbox"/>
<input type="text" value="device"/>	No Default Group		<input type="checkbox"/>	<input checked="" type="checkbox"/>	<input type="checkbox"/>	

- Click the configuration button ( ) under the More Settings heading to access more configuration options.
- Enter a password for the DEVICE profile in the Local Password field and record for future use.
- Set the Configure VPN Gateway to Yes.

- If the VPN needs to access the local network, configure the VPN Gateway section. This will allow traffic through the FieldServer to the IP Addresses on the local network.

For example:

- To allow access to all IP Address on 192.168.1.x subnet, type in “192.168.1.0/24”
- To only allow access to 192.168.1.50, type in “192.168.1.50/32”

The screenshot shows the configuration page for a device named "device". At the top, there is a dropdown menu for "No Default Group" and several status icons. The main configuration area is divided into several sections:

- Local Password:** A text input field with a "( Change Password )" button.
- Select IP Addressing:** Radio buttons for "Use Dynamic" (selected) and "Use Static".
- Access Control:**
  - Select addressing method:** Radio buttons for "Use NAT" (selected) and "Use routing".
  - Allow Access To these Networks:** A large text input field.
  - Allow Access From:** Checkboxes for "all server-side private subnets" (unchecked) and "all other VPN clients" (checked).
- VPN Gateway:**
  - Configure VPN Gateway:** Radio buttons for "No" and "Yes" (selected).
  - Allow client to act as VPN gateway for these client-side subnets:** A text input field containing "192.168.1.0/24".
- DMZ settings:**
  - Configure DMZ IP address:** Radio buttons for "No" (selected) and "Yes".

- Once configuration is complete, click the Save Settings button and then click the Update Running Server button.

A green notification box with the following text:

**User Permissions Changed**  
User 'device' added.

Press the button below to propagate the changes to the running server.

**Update Running Server**

A green notification box with the following text:

**Running Server Updated**  
The relevant components of the server have been restarted to activate the changes made to the active profile

## 11.3 Configure BACnet IoT Gateway for OpenVPN

### 11.3.1 Download the DEVIC Configuration Profile

- Login with the DEVICE credentials that were created in **Section 11.2.4**.

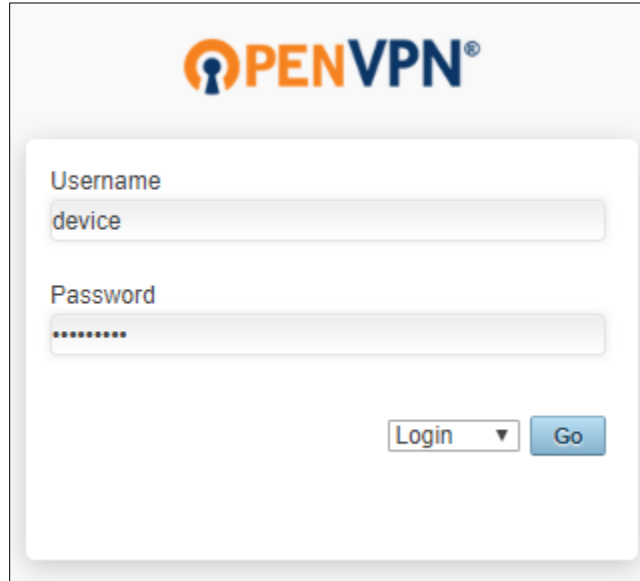

The image shows the OpenVPN login interface. At the top is the OpenVPN logo. Below it is a form with two input fields: 'Username' containing the text 'device' and 'Password' containing a series of dots. At the bottom right of the form are two buttons: 'Login' with a dropdown arrow and a blue 'Go' button.

- Click on “Yourself (autologin profile)”.
  - The DEVICE .opvn file will download to the default folder on the PC



The image shows the OpenVPN Connect app download page. At the top is the OpenVPN logo. Below it are two buttons: 'Connect' and 'Logout'. The main text reads: 'To download the OpenVPN Connect app, please choose a platform below:'. There are five bullet points with links: 'OpenVPN Connect for Windows', 'OpenVPN Connect for Mac OS X', 'OpenVPN Connect for Android', 'OpenVPN Connect for iOS', and 'OpenVPN for Linux'. Below this, it says 'Connection profiles can be downloaded for:' followed by two bullet points with links: 'Yourself (user-locked profile)' and 'Yourself (autologin profile)'.

- Click on Logout.

11.3.2 Load the DEVICE OpenVPN Connection Profile onto the BACnet IoT Gateway

The DEVICE .opvn file must be loaded onto the BACnet IoT Gateway for OpenVPN configuration.

- To do this, input the BACnet IoT’s IP Address into the local browser and login.
- Click the Settings tab to show the configurable settings types.
- Then click on the OpenVPN tab that appears to bring up the following page:

The screenshot shows a web interface for OpenVPN configuration. It includes a section for enabling/disabling the VPN connection, an update configuration section with a file browser and a 'Remove Config' button, and a 'VPN Stats' section with a table of connection statistics.

Stat	Value
Status	Online
Up time	03:31:03
Rx Bytes	13968
Tx Bytes	343893

- Click the Browse button under the Update VPN configuration header and select the DEVICE .opvn file to load it for OpenVPN configuration.
- Change the Enable VPN connection to Enable.
  - Once OpenVPN is enabled on the FieldServer, it will connect to the OpenVPN server.

**NOTE:** The connection statistics will be displayed in the VPN Stats section.

11.4 Install the OpenVPN Client onto a Local PC

11.4.1 Download the USER Configuration Profile

- Enter the server's IP Address into the local device's web browser.
- Go to the OpenVPN server and login with the USER credentials created in **Section 11.2.3**.

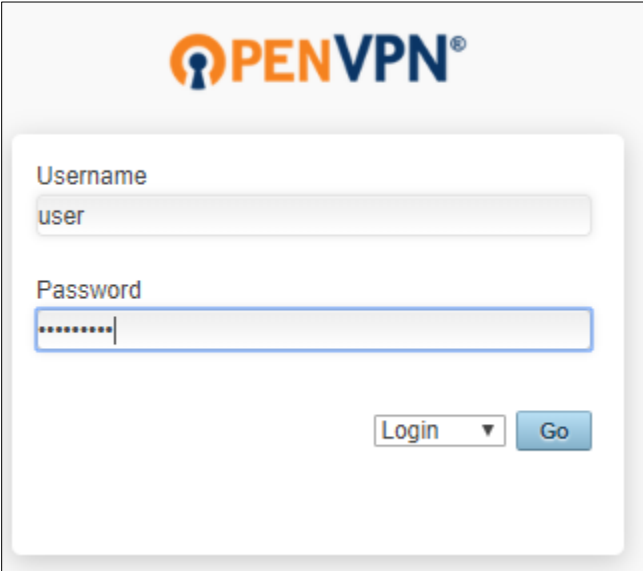

- Click on "Yourself (user-locked profile)".
  - The USER .opvn file will download to the default folder on the PC



- Click on Logout.

## 11.4.2 Load the USER OpenVPN Connection Profile onto the PC

- Download and install the OpenVPN client at:  
<https://swupdate.openvpn.org/community/releases/openvpn-install-2.4.6-l602.exe>
- Start the OpenVPN software by double clicking the OpenVPN GUI shortcut on the desktop.
- Right click the OpenVPN icon (  ) found in the system tray (on the right side of the taskbar).
  - If the icon isn't visible, click the upwards arrow in the system tray to find it

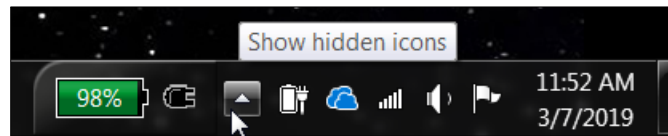

- Select the "Import file ..." option in the dropdown menu.
- Find and select the USER .opvn file on the local PC.
- Right click on the OpenVPN icon (  ) again and click the new "Connect" option in the dropdown menu.
- When the login window appears, enter the USER credentials.

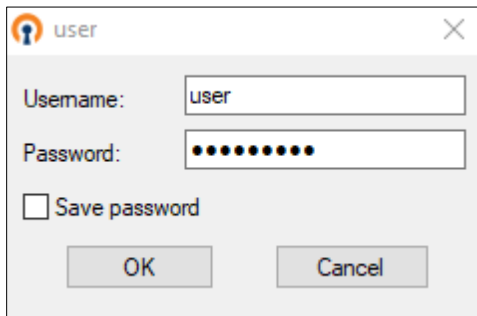

- A message will appear saying the OpenVPN connection has been established.



## 12 Specifications



FS-IOT-BAC, FS-IOT-BACW & FS-IOT-BACA/V/F <sup>1</sup>	
<b>Available Ports</b>	One 3-pin Phoenix connector with: RS-485/RS-232 port (TX+ / RX- / gnd) One 3-pin Phoenix connector with: Power port (+ / - / Frame-gnd) One Ethernet 10/100 BaseT port <b>BAC &amp; BACW include an additional:</b> RS-485 port (TX+ / RX- / gnd) <b>BAC2E includes an additional:</b> One Ethernet 10/100 BaseT port
<b>BAC/BACW/BAC2E Power Requirements</b>	<i>Input Voltage:</i> 9-30VDC or 24VAC <i>Current draw:</i> 24VAC 0.125A <i>Max Power:</i> 3 Watts                      9-30VDC 0.25A @12VDC
<b>BACA/V/F Power Requirements</b>	<i>Input Voltage:</i> 12-24V DC <i>Current draw:</i> @ 12V, 0.67A <i>Power Rating:</i> 8 Watts
<b>Approvals</b>	CE and FCC Class B & C Part 15, UL 62368 approved <sup>4</sup> , UL 916 approved <sup>2</sup> , WEEE compliant, IC Canada, RoHS compliant, REACH compliant, UKCA compliant, PTCRB <sup>3</sup> and CTIA <sup>3</sup>
<b>Dimensions (WxDxH)</b>	4 x 1.1 x 2.7 in (10.16 x 2.8 x 6.8 cm)
<b>Weight</b>	0.4 lbs (0.2 Kg)
<b>Operating Temperature</b>	-20 to 70°C (-4 to 158°F)
<b>Humidity</b>	10-95% RH non-condensing
<b>Wi-Fi 802.11 b/g/n<sup>3</sup></b>	<i>Frequency:</i> 2.4 GHz <i>Channels:</i> 1 to 11 (inclusive) <i>Antenna Type:</i> SMA <i>Encryption:</i> TKIP, WPA & AES
<b>Cellular<sup>4</sup></b>	<i>Features:</i> LTE Cat.4 <i>Antenna Type:</i> SMA <i>Uplink:</i> Up to 50 Mbps <i>Downlink:</i> Up to 150 Mbps

Figure 76: Specifications

“This device complies with part 15 of the FCC Rules. Operation is subject to the following two conditions:

- This device may not cause harmful interference
- This device must accept any interference received, including interference that may cause undesired operation.

**NOTE:** This equipment has been tested and found to comply with the limits for a Class A digital device, pursuant to part 15 of the FCC Rules. These limits are designed to provide reasonable protection against harmful interference when the equipment is operated in a commercial environment. This equipment generates, uses, and can radiate radio frequency energy and, if not installed and used in accordance with the instruction manual, may cause harmful interference to radio communications. Operation of this equipment in a residential area is likely to cause harmful interference in which case the user will be required to correct the interference at his expense.

Modifications not expressly approved by MSA Safety could void the user's authority to operate the equipment under FCC rules”.

<sup>1</sup> Specifications subject to change without notice

<sup>2</sup> Only for FS-IOT-BAC & FS-IOT-BACW

<sup>3</sup> Only for FS-IOT-BACW & FS-IOT-BACA/V/F

<sup>4</sup> Only for FS-IOT-BACA/V/F

## 13 References

### 13.1 Understanding FDR

The BACnet IoT Gateway doesn't allow FDR, local IP and BACnet MS/TP to co-exist because there is no guarantee that two distinct BACnet networks will have unique Device Instances or Network Numbers. (Unique Device Instances and Network Numbers are a requirement for BACnet to function properly). If local and remote options were allowed concurrently, the BACnet IoT Gateway would connect two networks that are probably not designed to work together. Forcing this situation would create extremely difficult to diagnose problems.

### 13.2 Understanding BACnet BBMD and NAT Routing

The BACnet IoT Gateway does not support NAT routing. However, the BACnet IoT Gateway must have the external IP Address and IP Port that the NAT router assigns to it, because these are inserted into the BACnet/IP BVLC header as the source IP Address which a remote recipient can use to reach the BBMD (BACnet Broadcast Management Device). This is necessary because the messages are distributed again by a remote BBMD, and the remote recipient of a distributed broadcast needs to reach the originator of the broadcast.

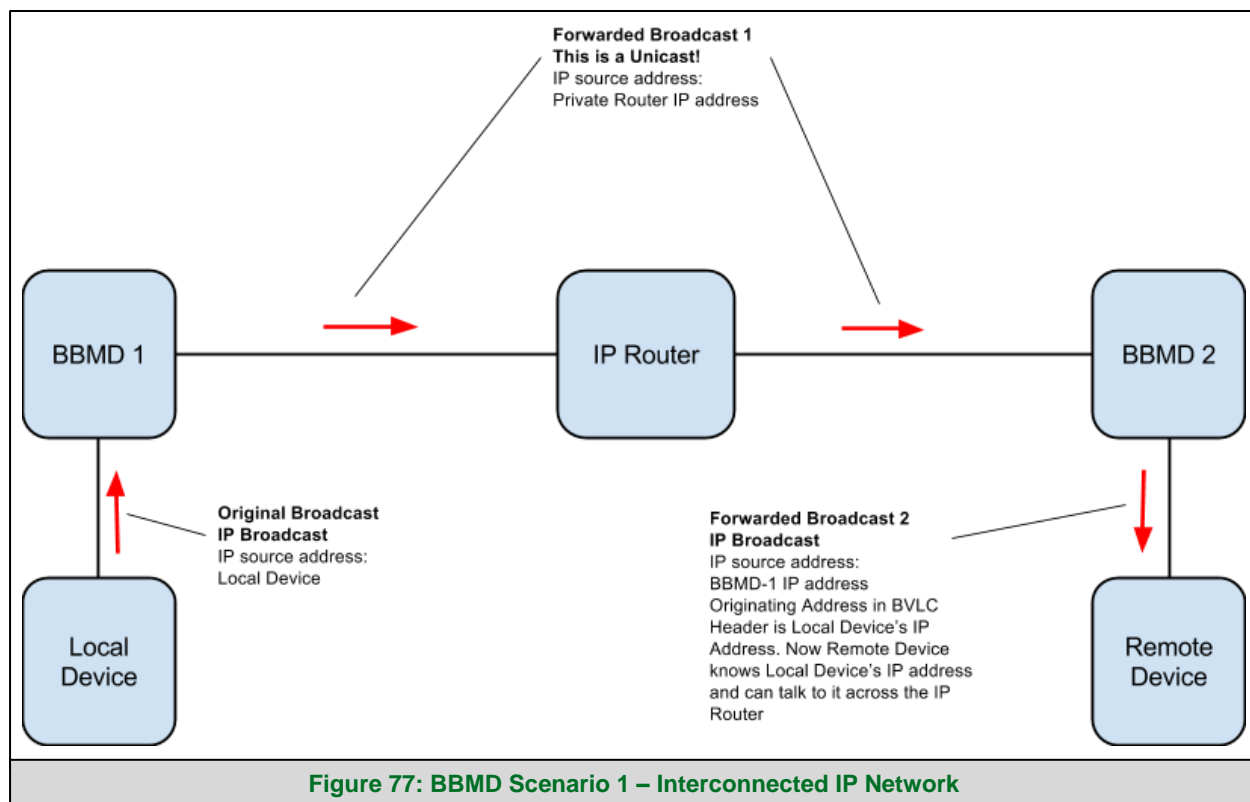

With NAT Routing, BBMD alone does not work because the Devices cannot reach each other's IP Addresses even if they know them. The only reachable address is the BBMD itself, so this must also act as a BACnet IoT Gateway to forward traffic to the intended device. When this is done, the destination device's IP Address and Port are encoded as the DADR in the network header, so that the Router can forward messages to the correct device.

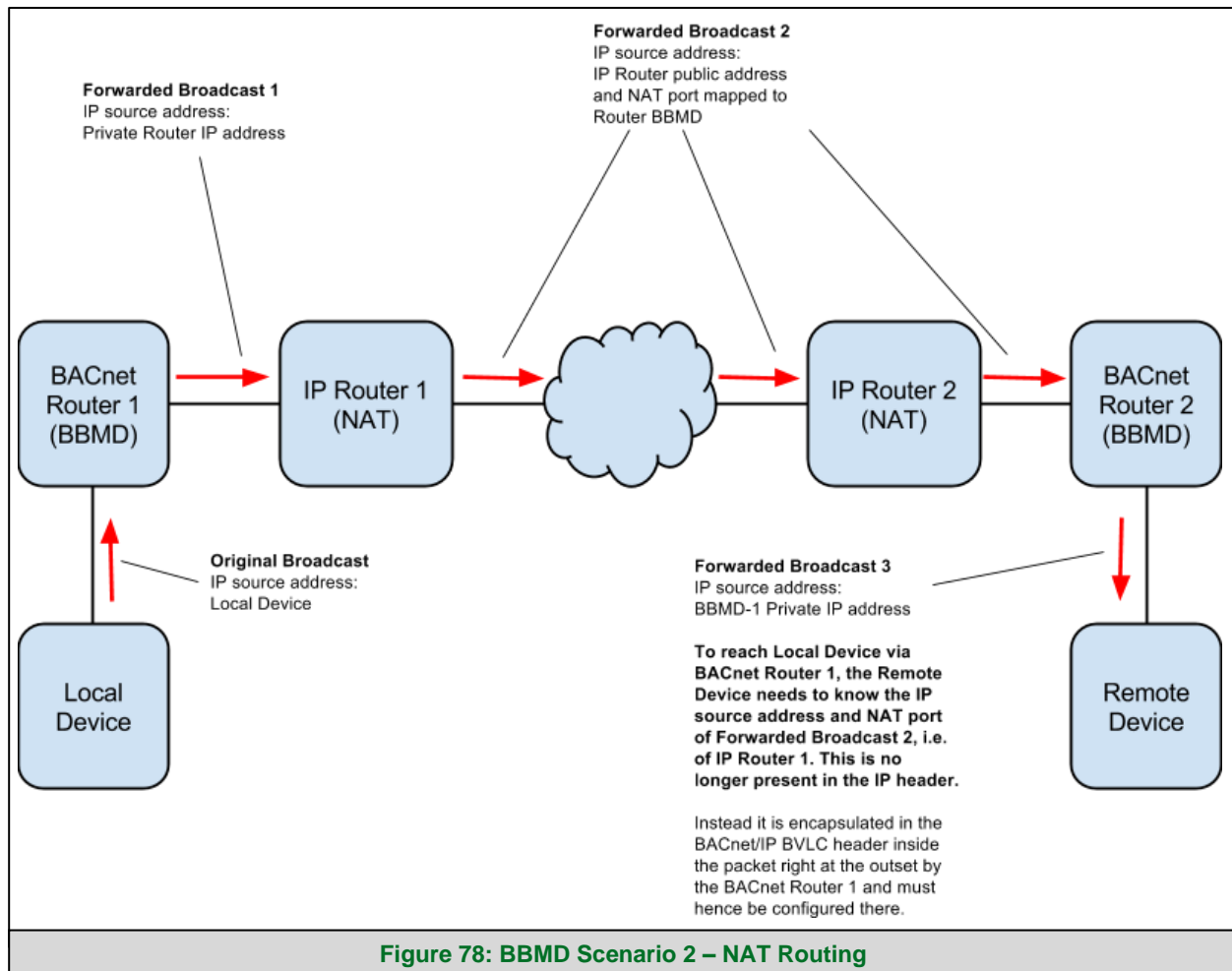

## 14 Troubleshooting

### 14.1 Communicating with the BACnet IoT Gateway Over the Network

- Confirm that the network cabling is correct.
- Confirm that the computer network card is operational and correctly configured.
- Confirm that there is an Ethernet adapter installed in the PC's Device Manager List, and that it is configured to run the TCP/IP protocol.
- Check that the IP netmask of the PC matches the BACnet IoT Gateway. The Default IP Address of the BACnet IoT Gateway is 192.168.2.101, Subnet Mask is 255.255.255.0.
  - Go to Start|Run
  - Type in "ipconfig"
  - The account settings should be displayed.
  - Ensure that the IP Address is 192.168.2.X and the netmask 255.255.255.0
- Ensure that the PC and BACnet IoT Gateway are on the same IP Network, or assign a Static IP Address to the PC on the 192.168.2.X network.

## 14.2 Lost or Incorrect IP Address

- Ensure that FieldServer Toolbox is loaded onto the local PC. Otherwise, download the FieldServer-Toolbox.zip via the MSA Safety website.
- Extract the executable file and complete the installation.

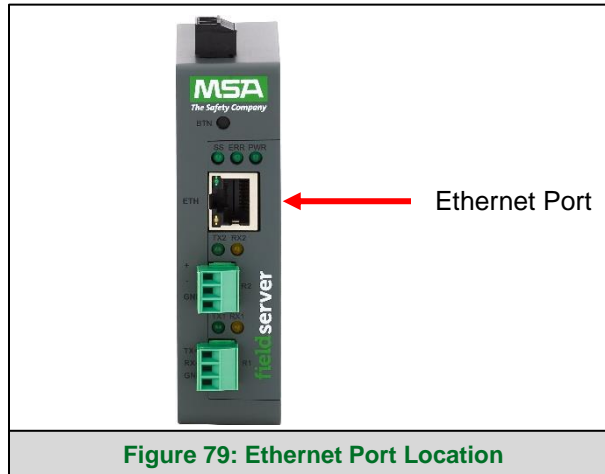

- Connect a standard Cat-5 Ethernet cable between the user's PC and BACnet IoT Gateway.
- Double click on the FS Toolbox Utility and click Discover Now on the splash page.
- Check for the IP Address of the desired gateway.

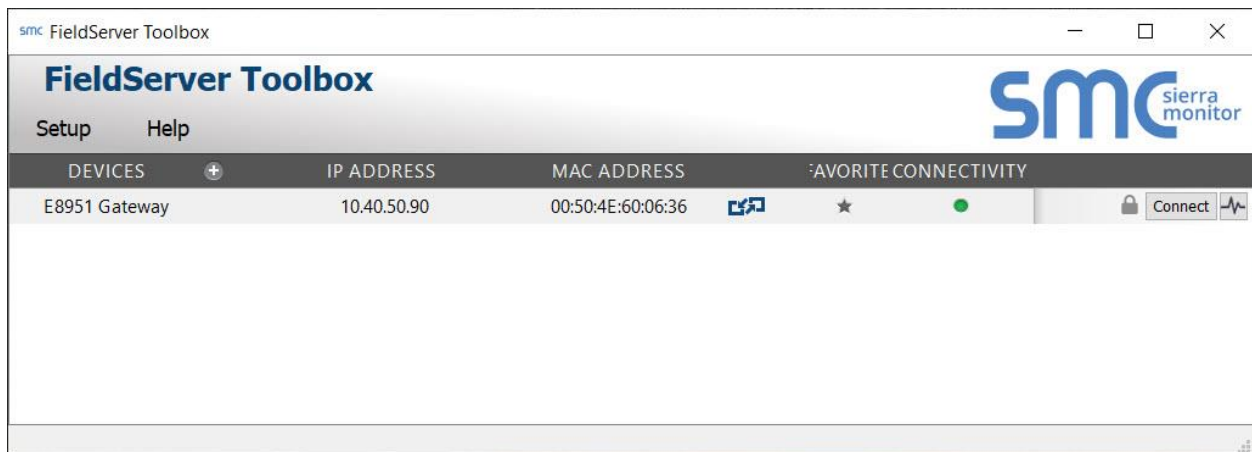

## 14.3 Viewing Diagnostic Information

- Type the IP Address of the BACnet IoT Gateway into the web browser or use the FieldServer Toolbox to connect to the BACnet IoT Gateway.
- Click on the blue “Diagnostics” text at the bottom of the page.
- Under the Navigation panel, click on view and then on connections.

**NOTE:** If there are any errors showing on the Connection page, refer to Section 14.4 for the relevant wiring and settings.

The screenshot shows the MSA BACnet Explorer web interface. The main content area is titled "Connections" and contains a table with the following data:

Index	Name	Tx Msg	Rx Msg	Tx Char	Rx Char	Errors
0	ETH1 - BACnet_IP 47800	775,235	736,558	0	0	0
1	ETH1 - BACnet_IP	738,766	779,593	0	0	0
2	R1 - BACnet_MSTP	490	0	0	0	0
3	R2 - BACnet_MSTP	490	0	0	0	0

The interface also features a navigation menu on the left with options like "About", "Setup", "View", and "Connections". The footer includes buttons for "Home", "HELP (?)", "Contact Us", "Reset Statistics", and "Logout", along with the "fieldserver" logo.

**Figure 80: Error Messages Screen**

## 14.4 Checking Wiring and Settings

No COMS on the Serial side. If the Tx/Rx LEDs are not flashing rapidly then there is a COM issue. To fix this problem, check the following:

- Visual observations of LEDs on the BACnet IoT Gateway (**Section 14.5**)
- Check baud rate, parity, data bits, stop bits
- Check Serial device address
- Verify wiring
- Verify device is connected to the same subnet as the BACnet IoT Gateway

No COMS on the Ethernet protocol. To fix this, check the following:

- Visual observations of LEDs on the BACnet IoT Gateway (**Section 14.5**)
- Check device address
- Verify wiring
- Verify device is connected to the same subnet as the BACnet IoT Gateway
- Verify IP Address setting

**NOTE:** If the problem still exists, a Diagnostic Capture needs to be taken and sent to support. (**Section 14.6**)

## 14.5 LED Diagnostics for Communications Between BACnet IoT Gateway and Devices

See the diagram below for BACnet IoT Gateway LED locations.

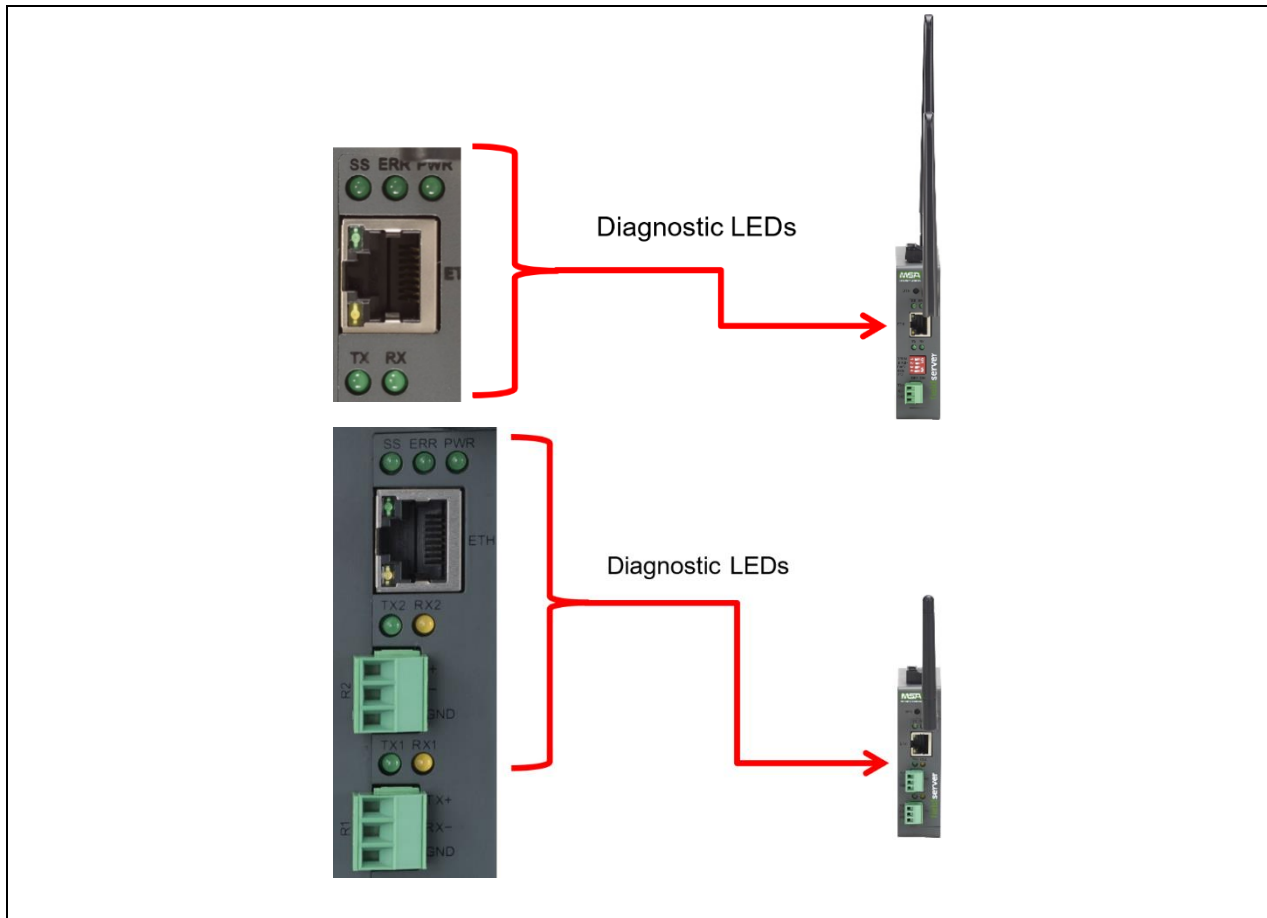

Tag	Description
SS	The SS LED will flash once a second to indicate that the bridge is in operation.
ERR	The SYS ERR LED will go on solid indicating there is a system error on unit. If this occurs, immediately report the related "system error" shown on the error screen of the FS-GUI to support for evaluation.
PWR	The power light should always show steady green when connected to a functioning power source.
RX	The RX LED will flash when a message is received on the serial port on the 3-pin connector. <b>If the serial port is not used, this LED is non-operational. For FS-IOT-BAC/BACW, RX1 applies to the R1 connection while RX2 applies to the R2 connection.</b>
TX	The TX LED will flash when a message is sent on the serial port on the 3-pin connector. <b>If the serial port is not used, this LED is non-operational. For FS-IOT-BAC/BACW, TX1 applies to the R1 connection while TX2 applies to the R2 connection.</b>

Figure 81: Diagnostic LEDs

## 14.6 Taking a FieldServer Diagnostic Capture

When there is a problem on-site that cannot easily be resolved, perform a Diagnostic Capture before contacting support. Once the Diagnostic Capture is complete, email it to technical support. The Diagnostic Capture will accelerate diagnosis of the problem.

- Access the FieldServer Diagnostics page via one of the following methods:
  - Open the FieldServer FS-GUI page and click on Diagnostics in the Navigation panel
  - Open the FieldServer Toolbox software and click the diagnose icon  of the desired device

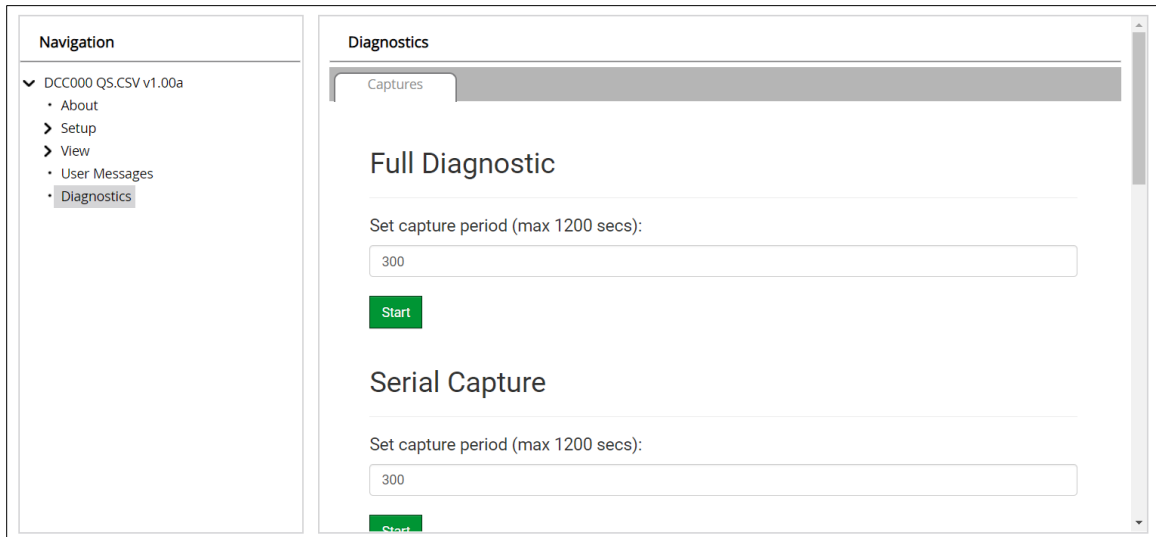

- Go to Full Diagnostic and select the capture period.
- Click the Start button under the Full Diagnostic heading to start the capture.
  - When the capture period is finished, a Download button will appear next to the Start button



- Click Download for the capture to be downloaded to the local PC.
- Email the diagnostic zip file to technical support ([smc-support.emea@msasafety.com](mailto:smc-support.emea@msasafety.com)).

**NOTE: Diagnostic captures of BACnet MS/TP communication are output in a “.PCAP” file extension which is compatible with Wireshark.**



## 14.7 Kaspersky Endpoint Security 10

If Kaspersky Endpoint Security 10 is installed on the user's PC, the software needs to be modified to allow the PC to register bridges on the Grid.

**NOTE:** This problem is specific to KES10, Kaspersky 2017 does not have this problem.

To fix the problem, the BACnet IoT Gateway ([http://192.168.100.85/\\*](http://192.168.100.85/*) in [Figure 83](#)) must be set as a trusted URL to the "Web Anti-Virus"->"Settings" as shown below.

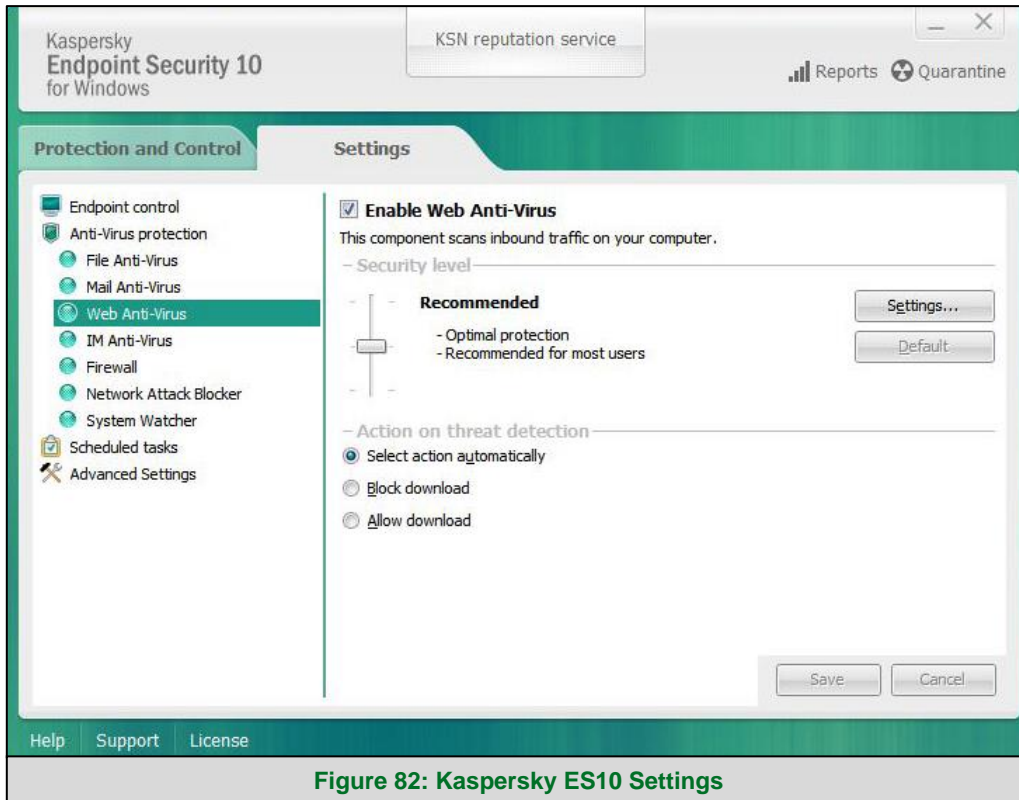

Figure 82: Kaspersky ES10 Settings

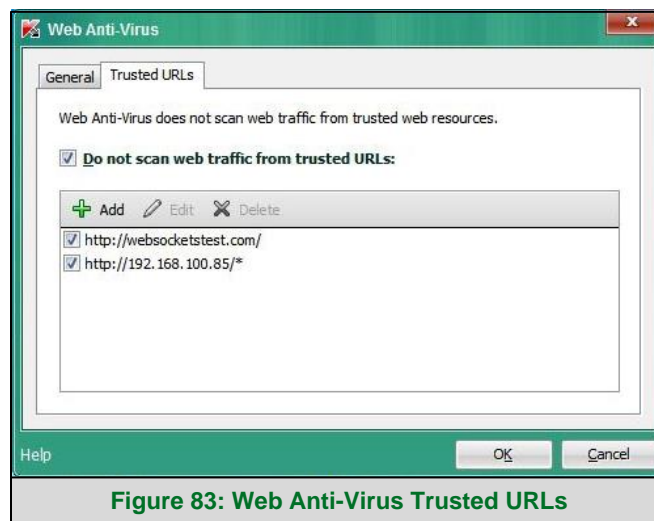

Figure 83: Web Anti-Virus Trusted URLs

## 14.8 Wi-Fi and Cellular Signal Strength

Wi-Fi	Cellular
<60dBm – Excellent	< 60dBm – Excellent
<70dBm – Very good	<70dBm – Very good
<80dBm – Good	<80dBm – Good
>80dBm – Weak	<90dBm – Weak
	>90dBm – Spotty; not good for data

**Figure 84: Wi-Fi & Cellular Signal Strength Listing**

**NOTE:** If the signal is weak or spotty, try to improve the signal strength by checking the antenna and the ProtoAir position.

## 14.9 Factory Reset Instructions

For instructions on how to reset a FieldServer back to its factory released state, see [ENOTE - FieldServer Recovery Instructions](#) or [ENOTE - FieldServer Next Gen Recovery](#).

## 14.10 Internet Browser Software Support

The following web browsers are supported:

- Chrome Rev. 57 and higher
- Firefox Rev. 35 and higher
- Microsoft Edge Rev. 41 and higher
- Safari Rev. 3 and higher

**NOTE:** Internet Explorer is no longer supported as recommended by Microsoft.

**NOTE:** Computer and network firewalls must be opened for Port 80 to allow FieldServer GUI to function.

## 14.11 APN Table

Use the table below to enter one of the correct APNs for your sim card:

Cellular Provider	APN
AT&T	broadband NXTGENPHONE
Verizon	Vzwinternet internet
Kore	c2.korem2m.com

**Figure 85: Cellular Provider APN**

### 14.12 Two Ethernet Port IP Subnets

If the user has one of the two Ethernet port units, the Eth1 and Eth2 ports need to be configured on different IP Subnets, otherwise the BACnet IOT Gateway will not be able to discover any BACnet IP or BACnet Ethernet devices on the network.

For example, if the ETH1 port is configured at 192.168.2.101, then the Eth 2 port cannot be configured with the same 192.168.2.XXX settings.

### 14.13 Data Missing on RESTful API and/or the Grid

If a RESTful API call for data fails and the BACnet IoT Gateway is not listed as a Device Name in the Data Logs found on the Grid, please ensure the following:

1. Check that the BACnet IoT Gateway has been registered to the Grid. (**Section 9.1**)
2. Check that the Monitor View has saved data. (**Section 8.2**)
3. Check that the Log checkbox has been enabled. (**Section 8.2.2**)

### 15 Additional Information

#### 15.1 Updating Firmware

To load a new version of the firmware, follow these instructions:

1. Extract and save the new file onto the local PC.
2. Open a web browser and type the IP Address of the FieldServer in the address bar.
  - Default IP Address is 192.168.2.101
  - Use the FS Toolbox utility if the IP Address is unknown (**Section 14.2**)
3. Click on the “Diagnostics & Debugging” button.
4. In the Navigation Tree on the left-hand side, do the following:
  - a. Click on “Setup”
  - b. Click on “File Transfer”
  - c. Click on the “General” tab
5. In the General tab, click on “Choose Files” and select the firmware file extracted in step 1.
6. Click on the orange “Submit” button.

When the download is complete, click on the “System Restart” button.

### 15.2 Change Web Server Security Settings After Initial Setup

**NOTE:** Any changes will require a FieldServer reboot to take effect.

- From the FS-GUI page, click Setup in the Navigation panel.

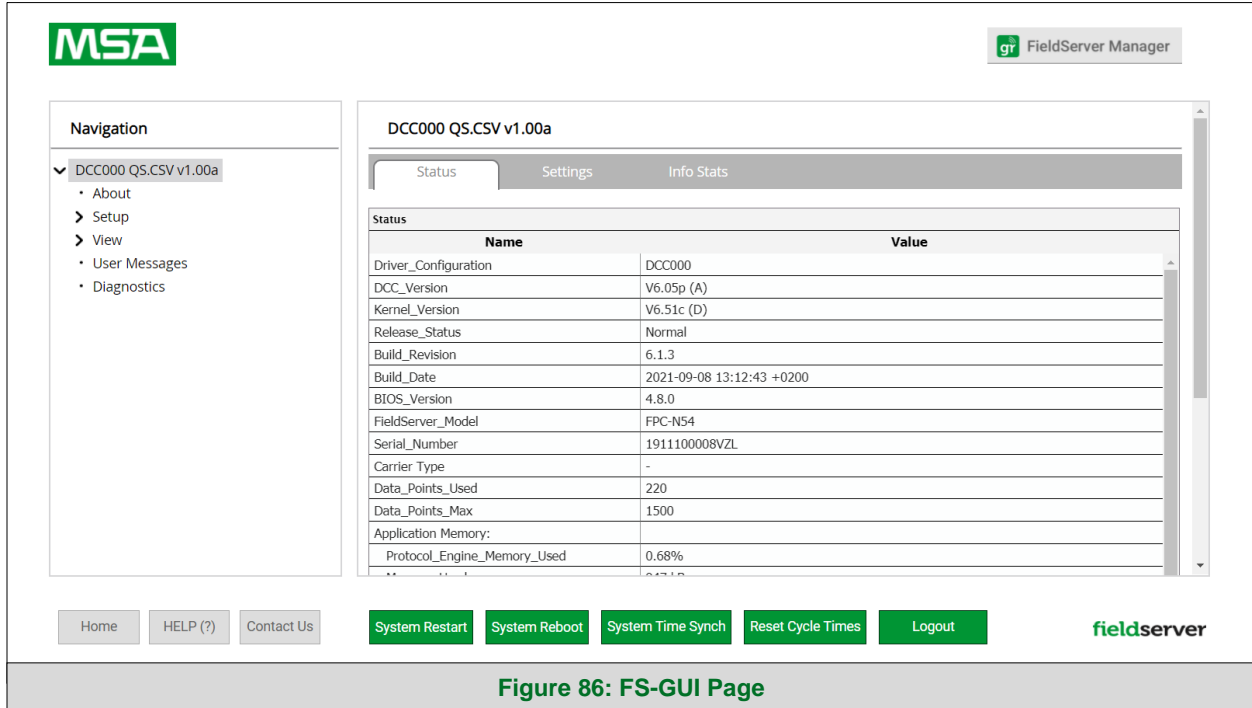
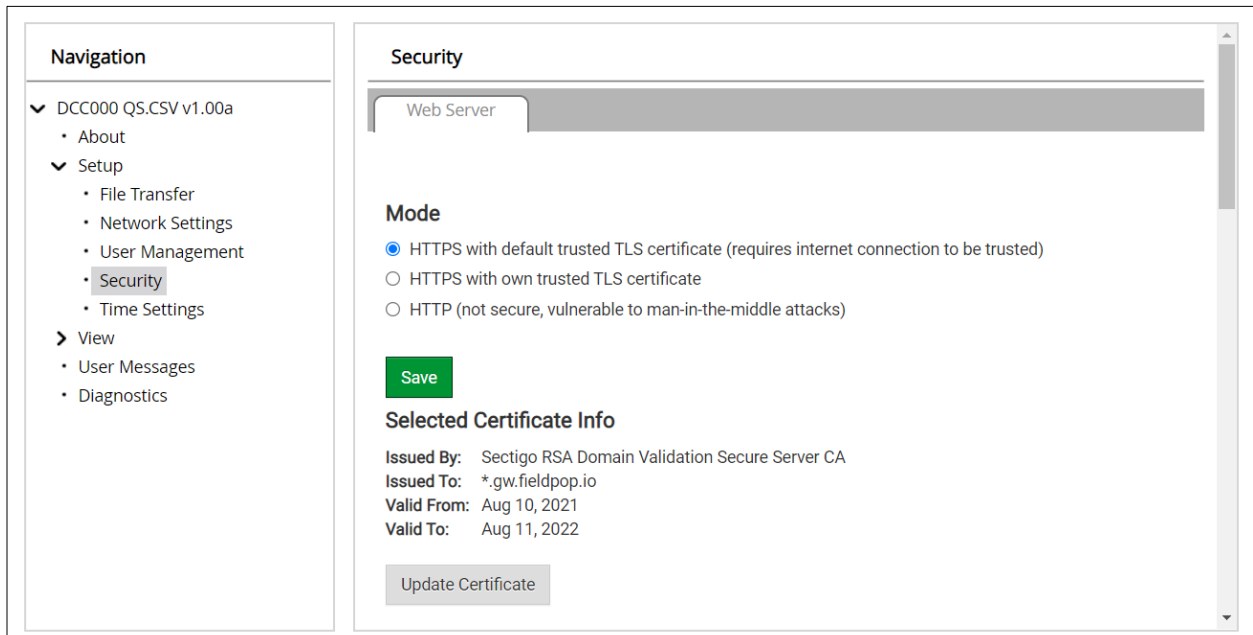

Figure 86: FS-GUI Page

## 15.2.1 Change Security Mode

- Click Security in the Navigation panel.



**Figure 87: FS-GUI Security Setup**

- Click the Mode desired.
  - If HTTPS with own trusted TLS certificate is selected, follow instructions in **Section 6.2.1**
- Click the Save button.

## 15.2.2 Edit the Certificate Loaded onto the FieldServer

**NOTE: A loaded certificate will only be available if the security mode was previously setup as HTTPS with own trusted TLS certificate.**

- Click Security in the Navigation panel.

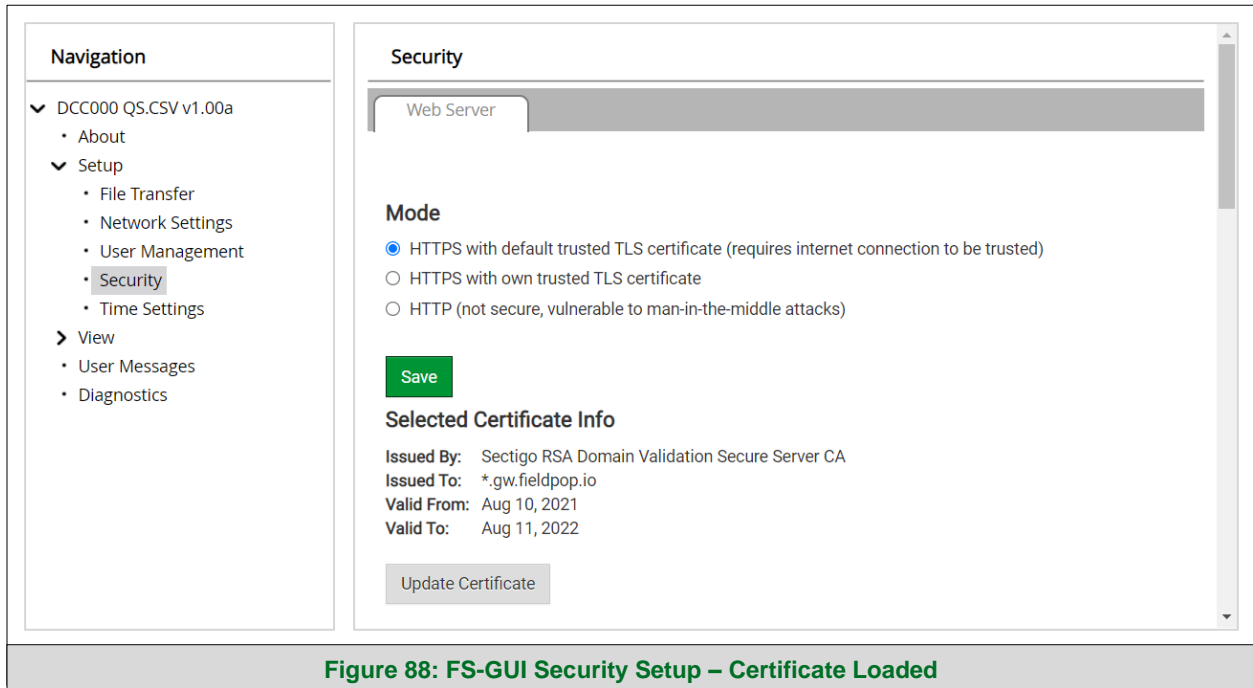

**Figure 88: FS-GUI Security Setup – Certificate Loaded**

- Click the Edit Certificate button to open the certificate and key fields.
- Edit the loaded certificate or key text as needed.
- Click Save.

## 15.3 Change User Management Settings

- From the FS-GUI page, click Setup in the Navigation panel.
- Click User Management in the navigation panel.

**NOTE:** If the passwords are lost, the unit can be reset to factory settings to reinstate the default unique password on the label. For recovery instructions, see the [FieldServer Next Gen Recovery document](#). If the default unique password is lost, then the unit must be mailed back to the factory.

**NOTE:** Any changes will require a FieldServer reboot to take effect.

- Check that the Users tab is selected.

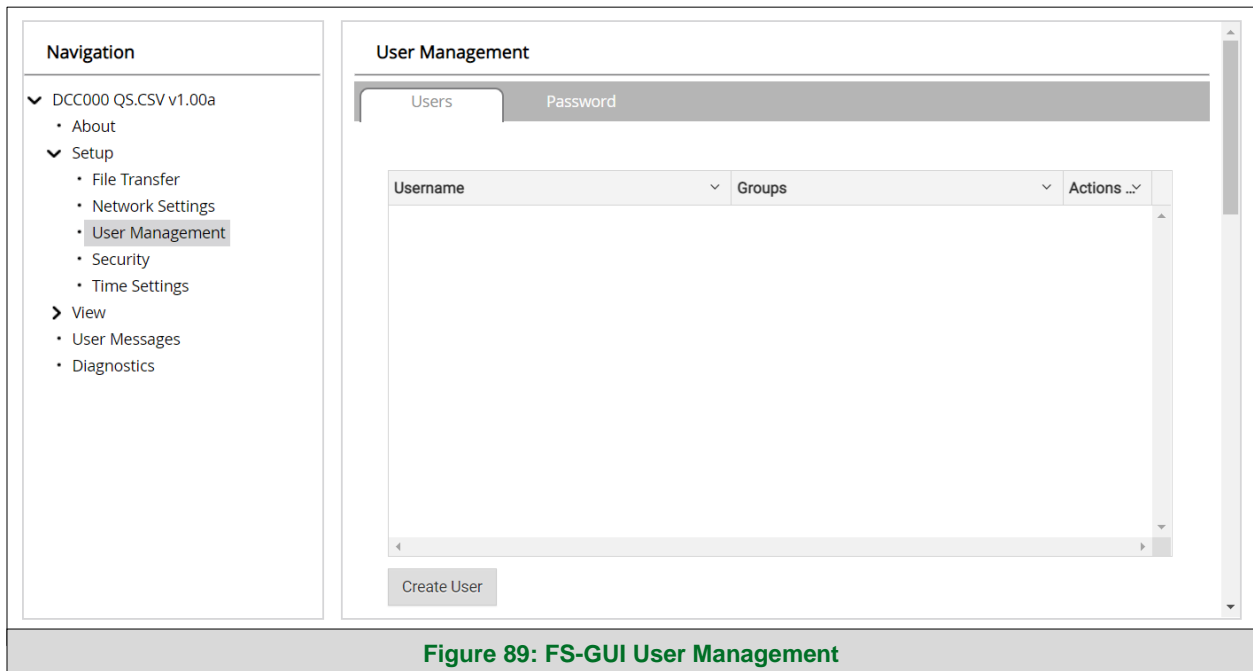

**Figure 89: FS-GUI User Management**

User Types:

**Admin** – Can modify and view any settings on the FieldServer.

**Operator** – Can modify and view any data in the FieldServer array(s).

**Viewer** – Can only view settings/readings on the FieldServer.



### 15.3.1 Create Users

- Click the Create User button.

**Create User**

**Username:**  
Enter a unique username

**Security Groups:**

- Admin
- Operator
- Viewer

**Password:** Weak  
Enter password

Show Passwords

**Confirm Password:**  
Confirm password

Generate Password

Create Cancel

**Figure 90: Create User Window**

- Enter the new User fields: Name, Security Group and Password.
  - **User details are hashed and salted**

**NOTE:** The password must meet the minimum complexity requirements. An algorithm automatically checks the password entered and notes the level of strength on the top right of the Password text field.

- Click the Create button.
- Once the Success message appears, click OK.

## 15.3.2 Edit Users

- Click the pencil icon next to the desired user to open the User Edit window.

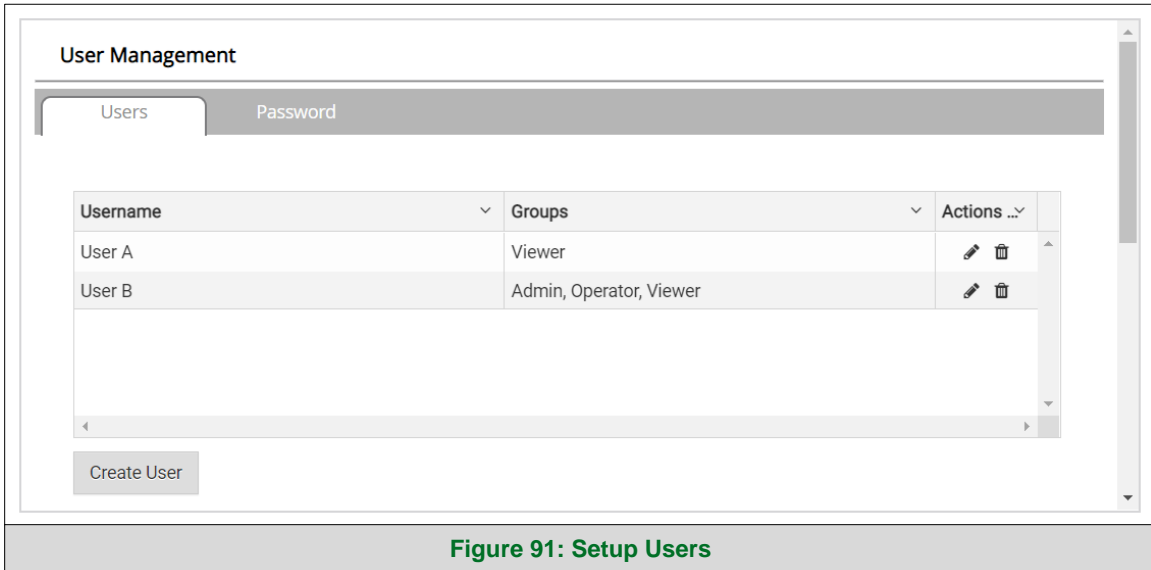

Figure 91: Setup Users

- Once the User Edit window opens, change the User Security Group and Password as needed.

The 'Edit User' window contains the following fields and options:

- Username:** Text input field containing 'User A'.
- Security Groups:** Three checkboxes:  Admin,  Operator, and  Viewer.
- Password:** Text input field containing 'Optional'.
- Show passwords
- Confirm Password:** Text input field containing 'Optional'.
- 
- (highlighted in green)
- 

Figure 92: Edit User Window

- Click Confirm.
- Once the Success message appears, click OK.

## 15.3.3 Delete Users

- Click the trash can icon next to the desired user to delete the entry.

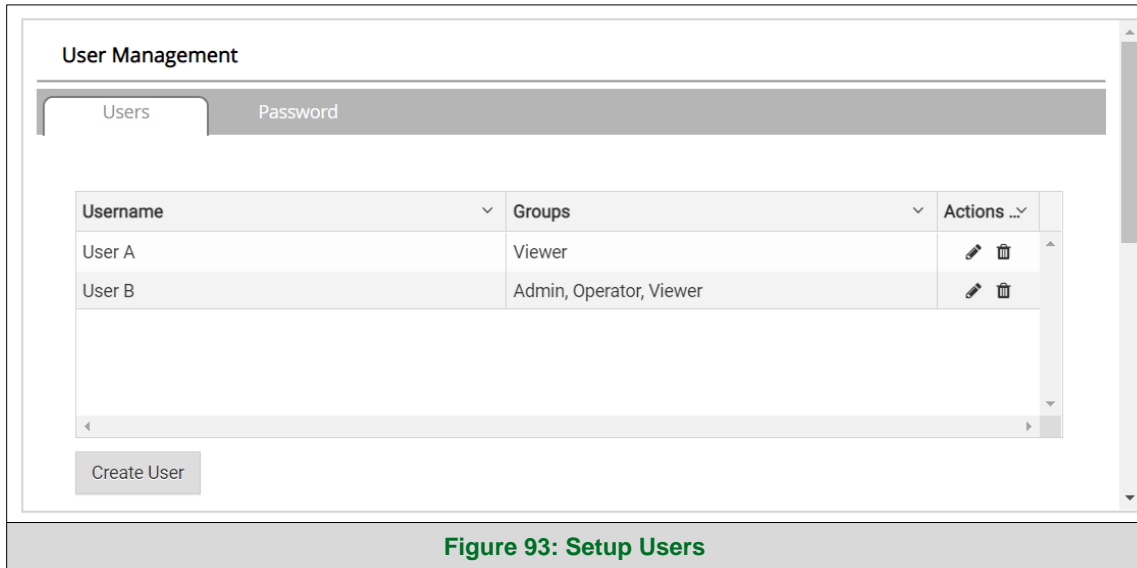

- When the warning message appears, click Confirm.

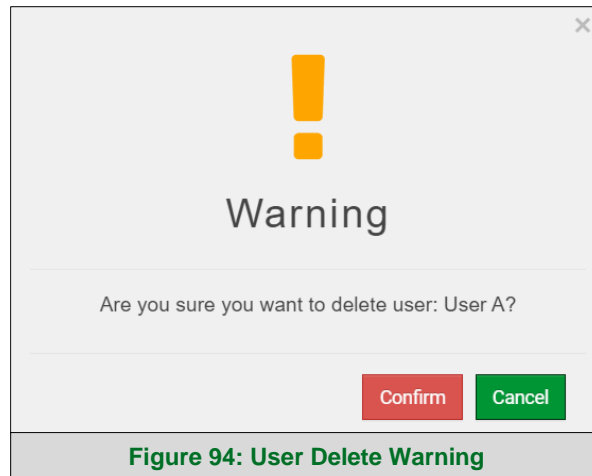

## 15.3.4 Change FieldServer Password

- Click the Password tab.

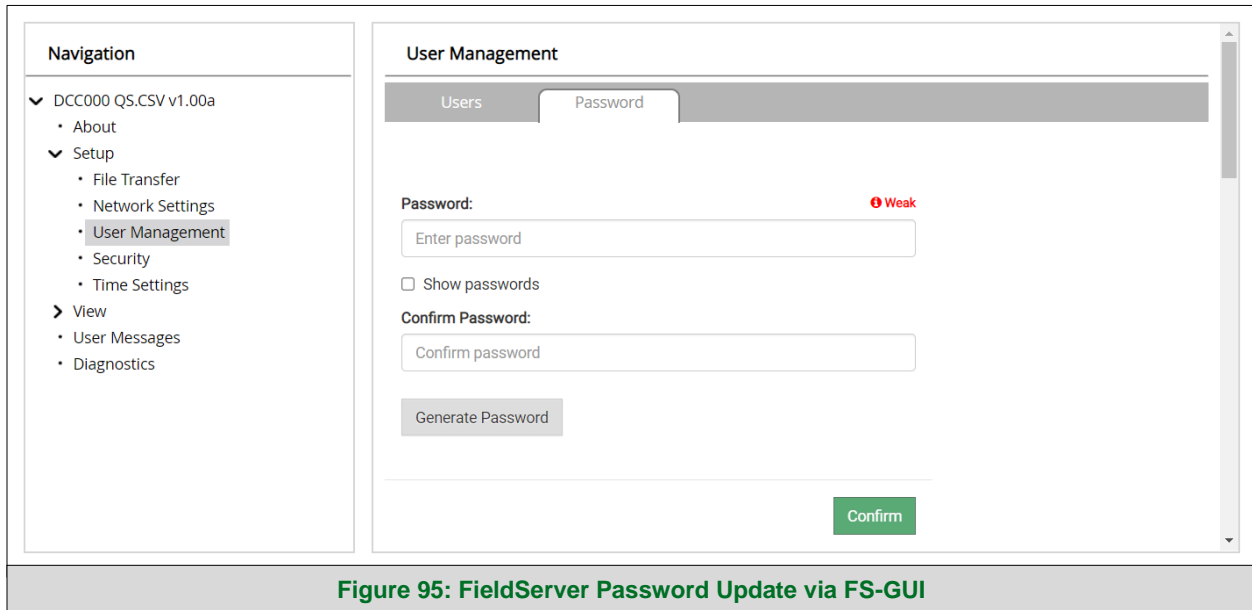

Figure 95: FieldServer Password Update via FS-GUI

- Change the general login password for the FieldServer as needed.

**NOTE:** The password must meet the minimum complexity requirements. An algorithm automatically checks the password entered and notes the level of strength on the top right of the Password text field.

## 15.4 System Status Button

The System Status Button can be found on any page of the web apps. This shows the level of alert/functionality for the customer device. This is an aggregate of the Web App page's resource usage upon the local PC or mobile device, the Grid connectivity and device alert level.

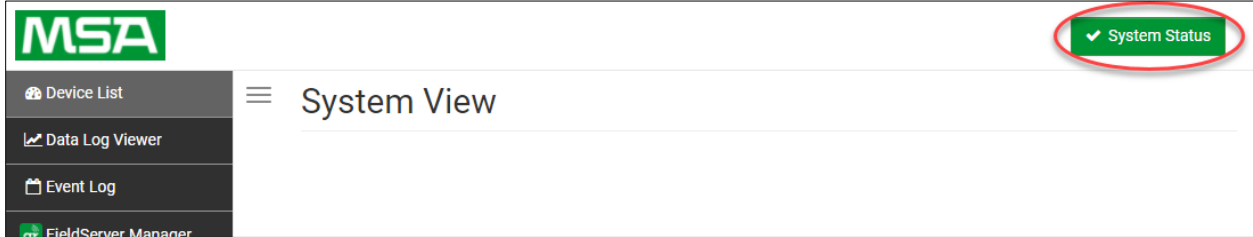

The color of the button represents the status of one to all three systems:

**Green** – Normal status

**Yellow** – Warning status

**Red** – Alarm status

Click on the System Status Button to open the System Status window, showing more details on the status of each system.

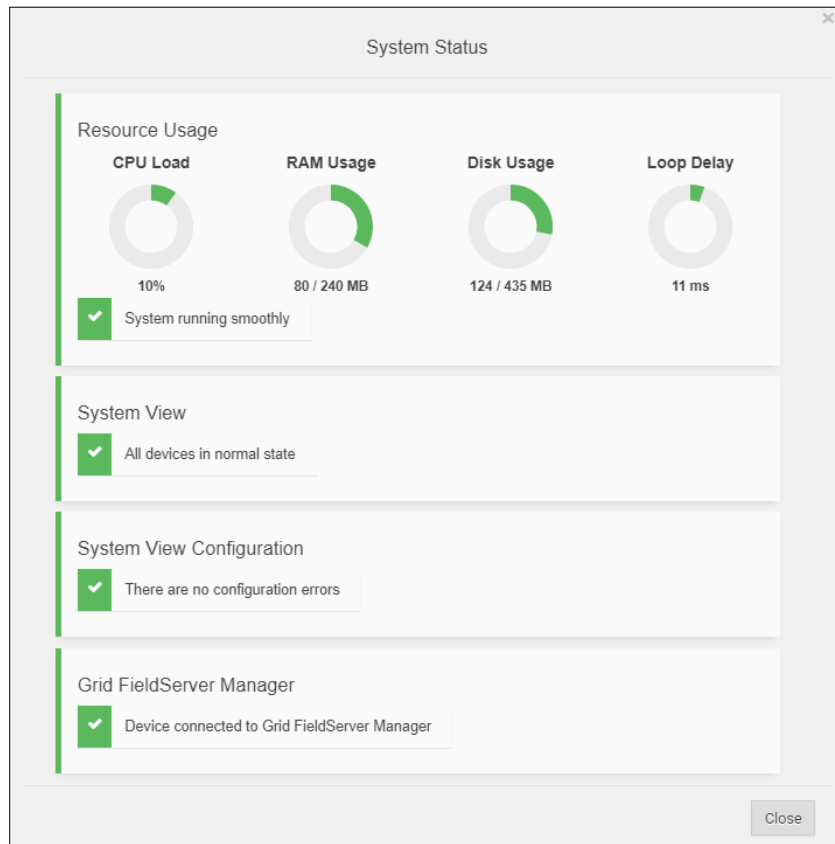

**NOTE:** If it was selected to opt out of the Grid, the cloud status will not show in the System Status window. This means the status will show as green even if the gateway is not connected to the Grid.