



FieldServer

QuickServer Start-up Guide

FS-QS-1011/12X0/12X1/1X50/1X51



APPLICABILITY & EFFECTIVITY

Effective for all systems manufactured after July 2020.

Document Revision: 2.J
T18600

Technical Support

Please call us for any technical support needs related to the FieldServer product.

MSA Safety
1991 Tarob Court
Milpitas, CA 95035

Website: www.sierramonitor.com

U.S. Support Information:

+1 408 964-4443

+1 800 727-4377

Email: smc-support@msasafety.com

EMEA Support Information:

+31 33 808 0590

Email: smc-support.emea@msasafety.com

TABLE OF CONTENTS

1	QuickServer Description	7
2	Supplied Equipment	7
3	Certifications	8
3.1	BTL Mark – BACnet Testing Laboratory	8
3.2	LonMark Certification.....	8
4	QuickServer Setup	9
4.1	Mounting.....	9
4.2	Dimensions.....	10
4.2.1	Dimension Drawing FS-QS-1X10-XXXX.....	10
4.2.2	Dimension Drawing FS-QS-1XX1-XXXX	11
4.2.3	Dimension Drawing FS-QS-123X Models with RS-422	12
4.3	R2 Port Jumper Settings	13
4.3.1	RS-485 Port.....	13
4.3.1.1	Bias Resistors	13
4.3.1.2	Termination Resistor	14
4.3.1.3	Power Jumper Settings.....	15
4.3.2	M-Bus Port: Master/Slave Jumper	16
4.4	R1 Port Small DIP Switches	17
4.4.1	RS-485 Port.....	17
5	Installing the QuickServer	18
5.1	RS-485.....	18
5.1.1	RS-485 Connection R2 Port.....	18
5.1.2	RS-485 Connection R1 Port.....	18
5.2	QuickServer LonWorks (FS-QS-1XX1-XXXX)	19
5.3	QuickServer KNX (FS-QS-124X-XXXX).....	19
5.4	RS-232 Connection R2 Port (only available on FS-QS-122X Models)	20
6	Operation	21
6.1	Power Up the Device.....	21
6.2	Connect the PC to the QuickServer Over the Ethernet Port	21
6.3	Connecting to the QuickServer.....	22
6.3.1	Using the FieldServer Toolbox to Discover and Connect to the QuickServer	22
6.3.2	Using a Web Browser to Connect to the QuickServer	22
7	Setup Web Server Security	23
7.1	Login to the FieldServer	23
7.2	Select the Security Mode.....	25
7.2.1	HTTPS with Own Trusted TLS Certificate.....	26
7.2.2	HTTPS with Default Untrusted Self-Signed TLS Certificate or HTTP with Built-in Payload Encryption	26
8	Configuring the QuickServer	27
8.1	Set IP Address of the QuickServer Using FS-GUI	28
8.2	Retrieve the Sample Configuration File.....	29
8.3	Change the Configuration File to Meet the Application	29
8.4	Load the Updated Configuration File.....	30
8.4.1	Using the FS-GUI to Load a Configuration File.....	30
8.4.2	Retrieve the Configuration File for Modification or Backup	31
8.5	Test and Commission the QuickServer	32
8.5.1	Accessing SMC Cloud.....	32
Appendix A	Useful Features	33
Appendix A.1	RS-422 Connection R2 Port	33
Appendix A.1.1	Connection and Operation via the RS-422 Port.....	34
Appendix A.2	KNX Connection R2 Port	35
Appendix A.3	M-Bus Connection R2 Port	36

Appendix A.4. SSL/TLS for Secure Connection.....	37
Appendix A.4.1. Configuring FieldServer as a SSL/TLS Server	37
Appendix A.4.1.1. Simple Secure Server Configuration	37
Appendix A.4.1.2. Limiting Client Access	38
Appendix A.4.1.3. To Upload the Authority File to the FieldServer	38
Appendix A.4.1.4. Certificate Validation Options	39
Appendix A.4.1.5. Set up Server Certificate	39
Appendix A.4.2. Configuring FieldServer as SSL/TLS Client.....	40
Appendix A.4.2.1. Simple Secure Client Configuration	40
Appendix A.4.2.2. Limit Server Access.....	40
Appendix A.4.2.3. Certificate Validation Options	40
Appendix A.4.2.4. Set up Client Certificate.....	40
Appendix B Vendor Information – M-Bus Data Profiles.....	41
Appendix B.1. Aquametro Calec ST Mappings to BACnet and Modbus	41
Appendix B.2. Comet XRM-50 Mappings to BACnet and Modbus	41
Appendix B.3. Elvaco CMA20 Mappings to BACnet and Modbus	41
Appendix B.4. EMU 3PH Power 3-85 Mappings to BACnet and Modbus	41
Appendix B.5. Kamstrup 601 Mappings to BACnet and Modbus	41
Appendix B.6. Kamstrup 602 Mappings to BACnet and Modbus	42
Appendix B.7. Sontay Zenner Multidata Mappings to BACnet and Modbus.....	42
Appendix B.8. Sontex SuperCal 531 Mappings to BACnet and Modbus.....	42
Appendix B.9. Siemens WFH21 Mappings to BACnet and Modbus.....	43
Appendix B.10. Siemens FUE950 Energy Mappings to BACnet and Modbus	43
Appendix B.11. QS All Data Profile Mappings to BACnet and Modbus.....	43
Appendix B.12. Kamstrup 66 Mappings to BACnet and Modbus	46
Appendix B.13. Amtron Sonic D Mappings to BACnet and Modbus.....	46
Appendix B.14. Shenitech STUF-280T Mappings to BACnet and Modbus	46
Appendix B.15. SensusHRI-B1-8Profile Mappings to BACnet and Modbus.....	47
Appendix B.16. KromSchroderTRZ2S1 Mappings to BACnet and Modbus	47
Appendix B.17. KromSchroderDE10R25-40B Mappings to BACnet and Modbus	47
Appendix B.18. RelayPadPulsM1 Mappings to BACnet and Modbus	50
Appendix B.19. AILA AUF200 Meter Data Profile Mappings to BACnet and Modbus.....	50
Appendix B.20. Siemens WFN21 Mappings to BACnet and Modbus.....	50
Appendix B.21. Siemens UH50 Mappings to BACnet and Modbus.....	50
Appendix B.22. Siemens T230 Mappings to BACnet and Modbus.....	50
Appendix B.23. Kamstrup Multical Mappings to BACnet and Modbus	51
Appendix B.24. Siemens UH50 Combined Mappings to BACnet and Modbus	51
Appendix B.25. Sensostar 2C Mappings to BACnet and Modbus	52
Appendix B.26. Axis SKU-03 Mappings to BACnet and Modbus	52
Appendix B.27. ECS Elec Mtr Mappings to BACnet and Modbus	52
Appendix B.28. Diehl Hydrus Mappings to BACnet and Modbus	53
Appendix B.29. Diehl Sharky 775 Mappings to BACnet and Modbus	53
Appendix B.30. Metz T M4 Mappings to BACnet and Modbus	53
Appendix B.31. Hydrometer Mappings to BACnet and Modbus	53
Appendix B.32. Kamstrup 402 Mappings to BACnet and Modbus	54
Appendix C Troubleshooting Tips	55
Appendix C.1. Communicating with the QuickServer Over the Network	55
Appendix C.2. Take a FieldServer Diagnostic Capture.....	56
Appendix C.2.1. Taking a Capture with Older Firmware	57
Appendix C.3. Internet Browser Software Support	59
Appendix C.4. Change Web Server Security Settings After Initial Setup	59
Appendix C.4.1. Change Security Mode	60
Appendix C.4.2. Edit the Certificate Loaded onto the FieldServer	61
Appendix C.5. Change User Management Settings	62
Appendix C.5.1. User Management.....	62
Appendix C.5.1.1. Create Users	63
Appendix C.5.1.2. Edit Users.....	64

Appendix C.5.1.3. Delete Users	65
Appendix C.5.2. Change FieldServer Password	66
Appendix D Reference	67
Appendix D.1. LED Functions	67
Appendix D.2. QuickServer FS-QS-101X DCC	68
Appendix D.3. QuickServer 1XXX Part Numbers	68
Appendix D.4. Compliance with UL Regulations.....	69
Appendix D.5. Specifications.....	70
Appendix E Limited 2 Year Warranty	71

LIST OF FIGURES

Figure 1: DIN Rail.....	9
Figure 2: FS-QS-1X10-XXXX.....	10
Figure 3: FS-QS-1XX1-XXXX.....	11
Figure 4: FS-QS-123X models with RS-422.....	12
Figure 5: Bias Resistor Jumper.....	13
Figure 6: Termination Resistor Jumper.....	14
Figure 7: Power Jumper Switch.....	15
Figure 8: Setting Master/Slave Jumper.....	16
Figure 9: Bias Resistor DIP Switches & EOL.....	17
Figure 10: RS-485 R2 Connection Port.....	18
Figure 11: RS-485 R1 Connection Port.....	18
Figure 12: LonWorks Commissioning and Port.....	19
Figure 13: KNX Commissioning.....	19
Figure 14: RS-232 R2 Connection Port.....	20
Figure 15: Connecting Power.....	21
Figure 16: Ethernet Port.....	21
Figure 17: Web Server Security Unconfigured Window.....	23
Figure 18: Connection Not Private Warning.....	23
Figure 19: Warning Expanded Text.....	24
Figure 20: FieldServer Login.....	24
Figure 21: Security Mode Selection Screen.....	25
Figure 22: Security Mode Selection Screen.....	26
Figure 23: FS-GUI Landing Page.....	27
Figure 24: FS-GUI Network Settings.....	28
Figure 25: FS-GUI File Transfer.....	29
Figure 26: FS-GUI Loading Files.....	30
Figure 27: Retrieve Configuration File.....	31
Figure 28: FS-GUI Connections Page.....	32
Figure 29: RS-422 Unit.....	33
Figure 30: RS-422 Connectors.....	34
Figure 31: KNX Unit.....	35
Figure 32: M-Bus R2 Port.....	36
Figure 33: Ethernet Port Location.....	57
Figure 34: FS-GUI Landing Screen.....	59
Figure 35: FS-GUI Security Setup.....	60
Figure 36: FS-GUI Security Setup – Certificate Loaded.....	61
Figure 37: FS-GUI User Management.....	62
Figure 38: Create User Window.....	63
Figure 39: Setup Users.....	64
Figure 40: Edit User Window.....	64
Figure 41: Setup Users.....	65
Figure 42: User Delete Warning.....	65
Figure 43: FieldServer Password Update via FS-GUI.....	66
Figure 44: FS-QS-1XXX LEDs.....	67
Figure 45: Specifications.....	70

1 QUICKSERVER DESCRIPTION

QuickServer is a high performance, cost effective Building and Industrial Automation multi-protocol gateway providing protocol translation between serial, Ethernet, and LonWorks¹ devices and networks.

NOTE: For troubleshooting assistance refer to Appendix B, or any of the troubleshooting appendices in the related driver supplements. Check the [Sierra Monitor website](#) for technical support resources and documentation that may be of assistance.

The QuickServer is cloud ready and connects with MSA Safety's SMC Cloud. See **Section 8.5.1** for further information.

2 SUPPLIED EQUIPMENT

QuickServer Gateway

- Preloaded with two selected drivers (on the FS-QS-1X11 and FS-QS-12X1 one of those drivers is LonWorks). A sample configuration file is also pre-loaded onto the QuickServer.
- All instruction manuals, driver manuals, support utilities are available on the USB drive provided in the optional accessory kit, or on the [Sierra Monitor website](#).

Accessory kit (optional) (Part # FS-8915-36-QS) includes:

- 7-ft Cat-5 cable with RJ45 connectors at both ends
- Power Supply -110/220V (p/n 69196)
- DIN rail mounting bracket
- Screwdriver for connecting to terminals
- USB Flash drive loaded with:
 - QuickServer Start-up Guide
 - FieldServer Configuration Manual
 - All FieldServer Driver Manuals
 - Support Utilities
 - Any additional folders related to special files configured for a specific QuickServer
 - Additional components as required – see Driver Manual Supplement for details



¹ LonWorks is a registered trademark of Echelon Corporation.

3 CERTIFICATIONS

3.1 BTL Mark – BACnet² Testing Laboratory



BACnet is a registered trademark of ASHRAE. ASHRAE does not endorse, approve or test products for compliance with ASHRAE standards. Compliance of listed products to requirements of ASHRAE Standard 135 is the responsibility of the BACnet International. BTL is a registered trademark of the BACnet International.

The BTL Mark is a symbol that indicates that a product has passed a series of rigorous tests conducted by an independent laboratory which verifies that the product correctly implements the BACnet features claimed in the listing. The mark is a symbol of a high-quality BACnet product.

Go to www.BACnetInternational.net for more information about the BACnet Testing Laboratory. Click [here](#) for the BACnet PIC Statement.

3.2 LonMark Certification



LonMark International is the recognized authority for certification, education, and promotion of interoperability standards for the benefit of manufacturers, integrators and end users. LonMark International has developed extensive product certification standards and tests to provide the integrator and user with confidence that products from multiple manufacturers utilizing LonMark devices work together. MSA Safety has more LonMark Certified gateways than any other gateway manufacturer, including the QuickServer, ProtoCessor, ProtoCarrier and ProtoNode for OEM applications and the full featured, configurable gateways.

² BACnet is a registered trademark of ASHRAE.

4 QUICKSERVER SETUP

4.1 Mounting

The following mounting options are available:

- Product comes with tabs for wall or surface mount. These can be snapped off if not required.
- DIN rail mounting bracket – Included in the accessory kit or ordered separately (part # FS-8915-35-QS).

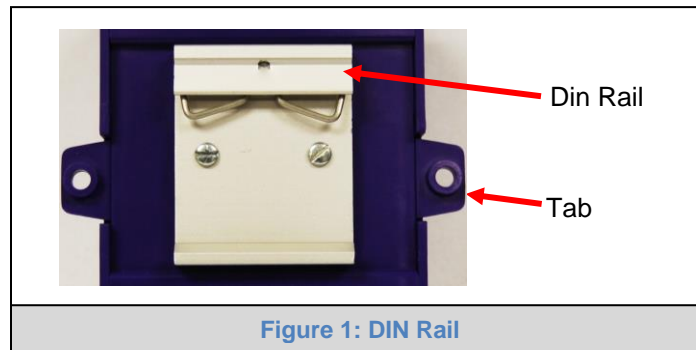

Figure 1: DIN Rail

WARNING: Install only as instructed, failure to follow the installation guidelines or using screws without the DIN rail mounting bracket could result in permanent damage to the product. If the FieldServer is removed from the DIN rail, use the original screws to reattach. Only screws supplied by MSA Safety should be used in the holes found on the back of the unit when attaching the optional DIN Rail bracket. **USE OF ANY OTHER SCREWS MAY DAMAGE THE UNIT.**

4.2 Dimensions

4.2.1 Dimension Drawing FS-QS-1X10-XXXX

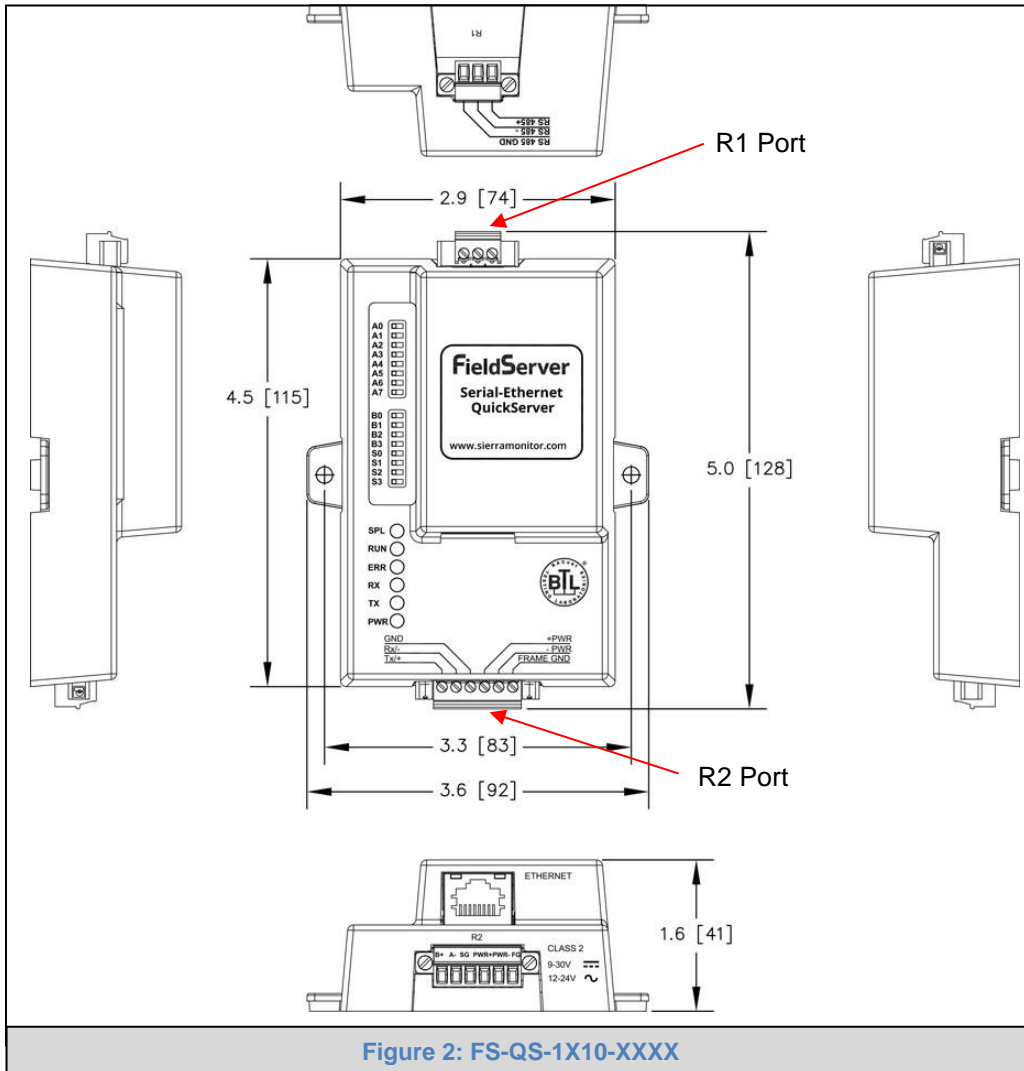

Figure 2: FS-QS-1X10-XXXX

4.2.2 Dimension Drawing FS-QS-1XX1-XXXX

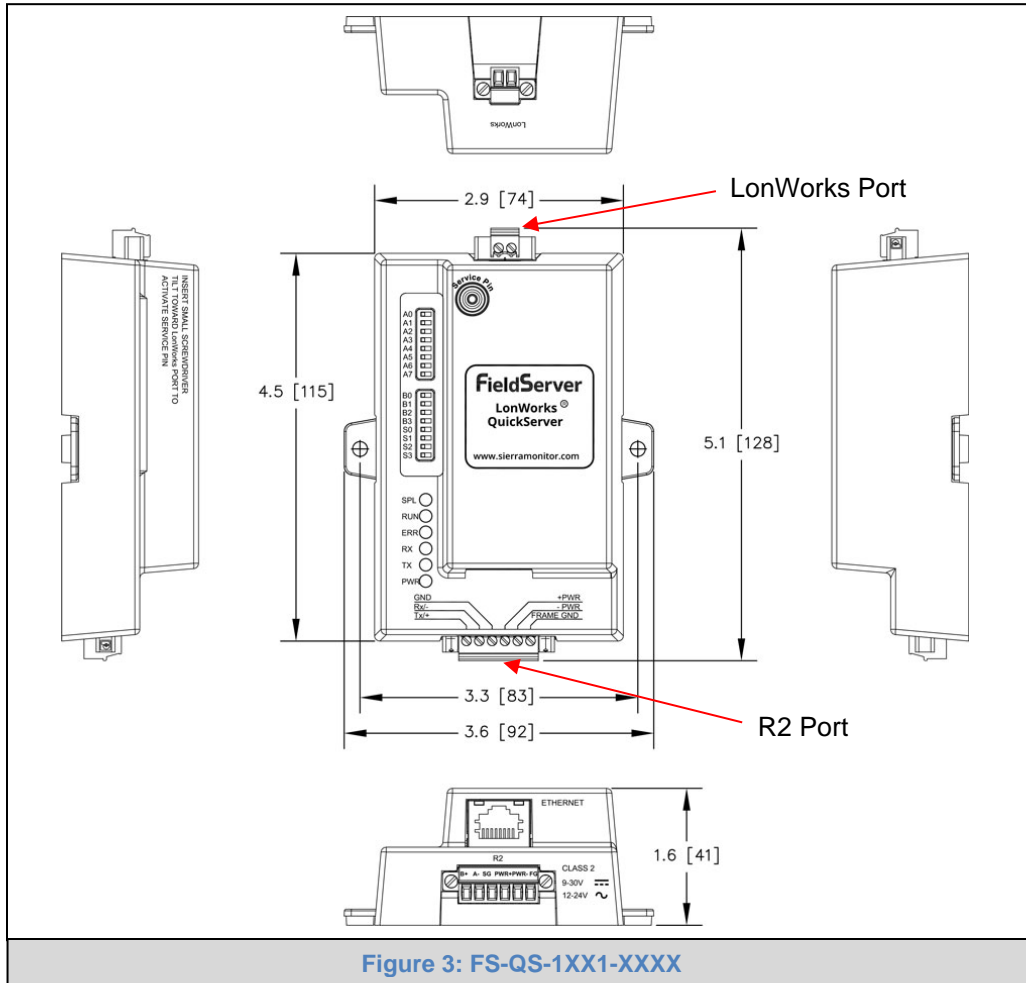

Figure 3: FS-QS-1XX1-XXXX

4.2.3 Dimension Drawing FS-QS-123X Models with RS-422

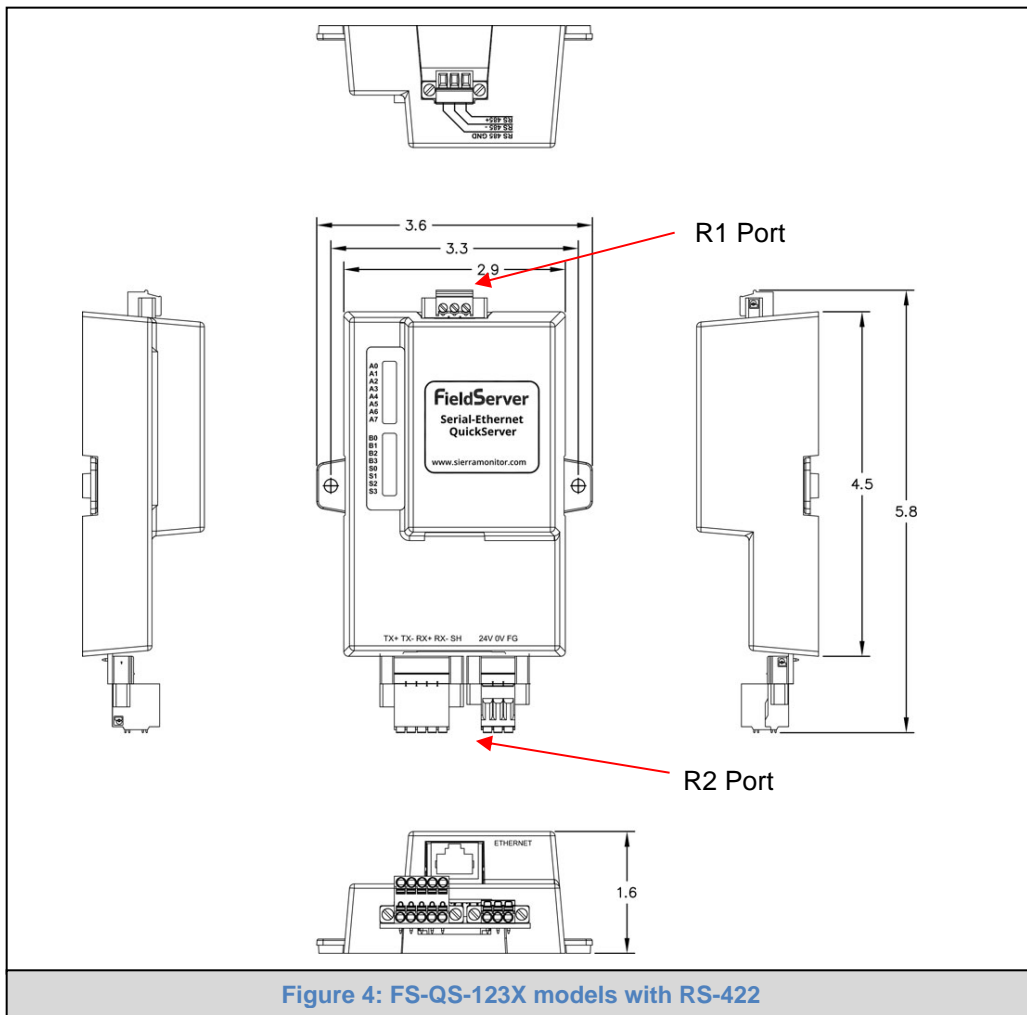

Figure 4: FS-QS-123X models with RS-422

4.3 R2 Port Jumper Settings

Gently remove the QuickServer enclosure to access the jumpers on the unit.

4.3.1 RS-485 Port

NOTE: The following Sections only apply to QuickServer models: FS-QS-1011 and FS-QS-1211.

4.3.1.1 Bias Resistors

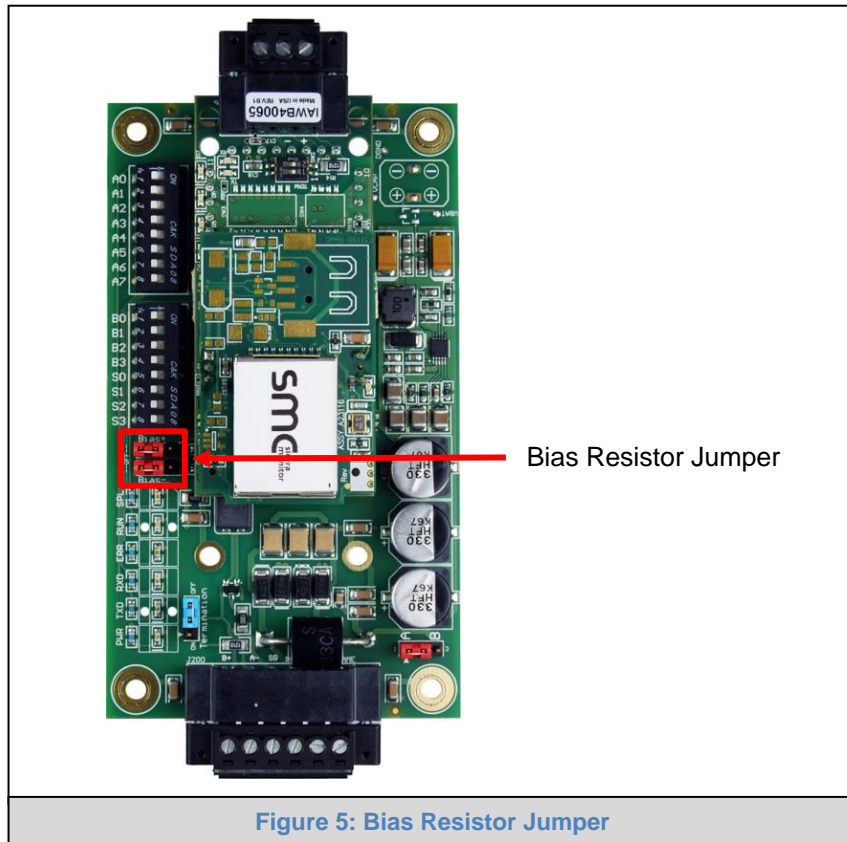

Figure 5: Bias Resistor Jumper

The QuickServer bias resistors are used to keep the RS-485 bus to a known state, when there is no transmission on the line (bus is idling), to help prevent false bits of data from being detected. The bias resistors typically pull one line high and the other low - far away from the decision point of the logic.

In the RS-485 carrier, the bias resistor is 510 ohms which is in line with the BACnet spec. It should only be enabled at one point on the bus (on the field port were there are very weak bias resistors of 100k). Since there are no jumpers, many FieldServers can be put on network without running into the bias resistor limit which is < 500 ohms.

NOTE: See www.ni.com/support/serial/resinfo.htm for additional pictures and notes.

4.3.1.2 Termination Resistor

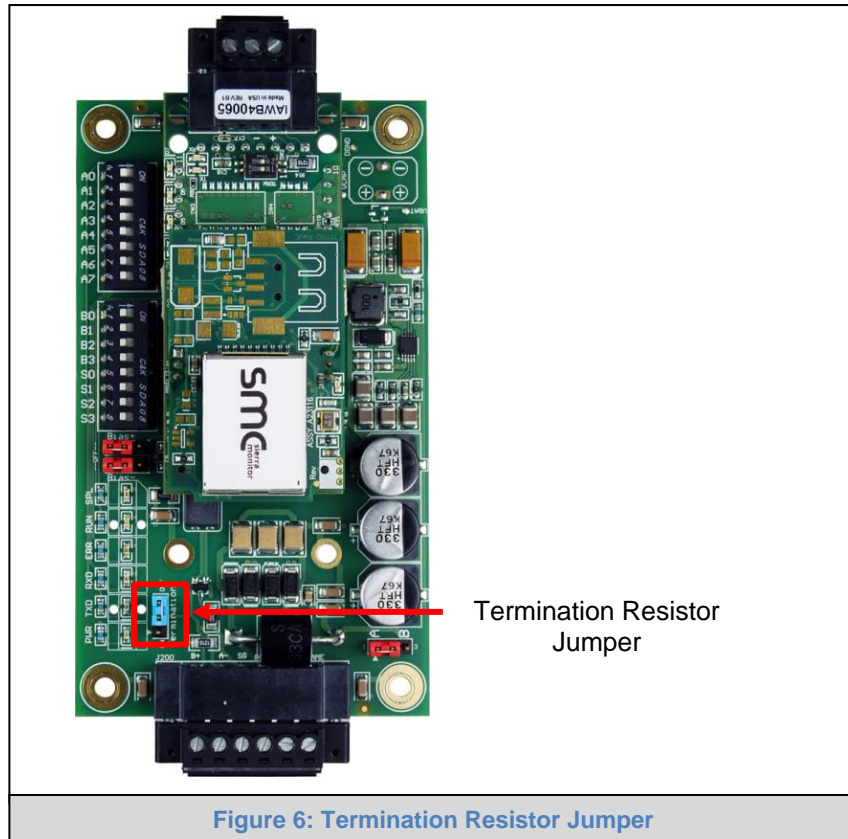
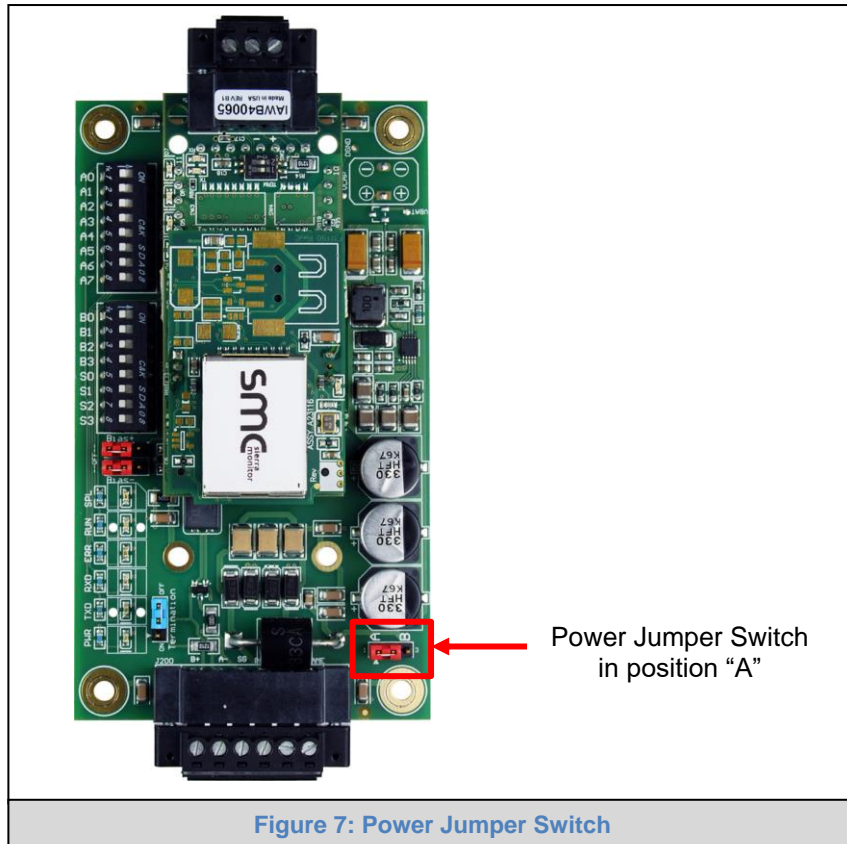

Figure 6: Termination Resistor Jumper

Termination resistors are also used to reduce noise. These pull the two lines of an idle bus together. However, they would override the effect of any bias resistors, if connected.

4.3.1.3 Power Jumper Settings



The QuickServer Carrier Board power jumper is set to position A by default but can be changed to position B for other power supply requirements.

Position A: The Carrier makes use of a full-wave rectifying bridge. Can be used for 12-24VAC input or 9 – 30VDC input. At 9VDC this becomes marginal.

Position B: The Carrier makes use of a half-wave rectifying bridge. Best position for grounded AC transformers and for using DC voltage down to 9VDC.

4.3.2 M-Bus Port: Master/Slave Jumper

NOTE: The following only applies to models: FS-QS-1A50, FS-QS-1A51, FS-QS-1B51, FS-QS-1B51, FS-QS-1C51 and FS-QS-1C51.

The Master/Slave jumper is used to set the M-Bus hardware as a Master or Slave device (indicated by the labels on the board).

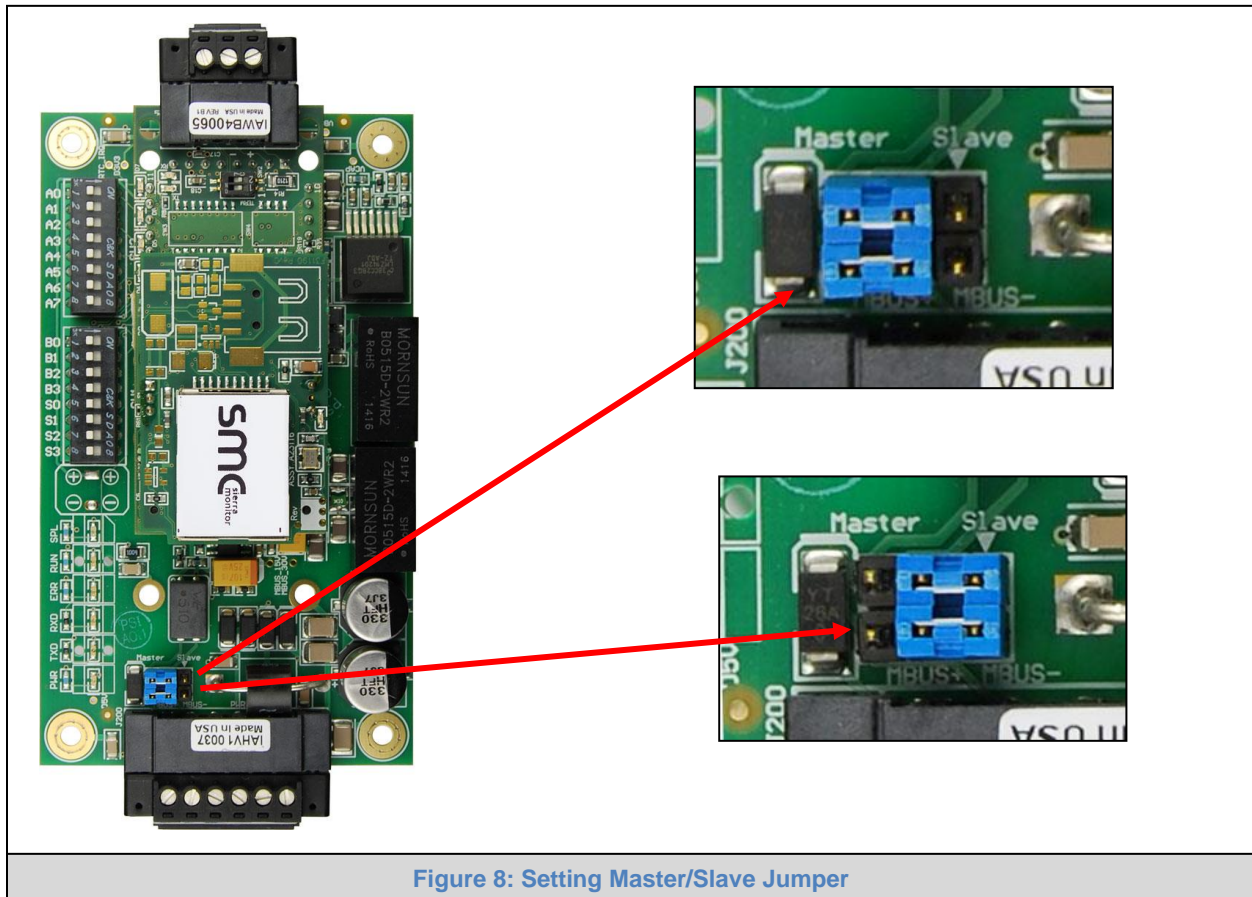

Figure 8: Setting Master/Slave Jumper

4.4 R1 Port Small DIP Switches

Gently remove the QuickServer enclosure to access the small DIP switches for the R1 Port.

4.4.1 RS-485 Port

NOTE: The following only applies to QuickServer models FS-QS-1XX0 or all non-LonWorks models.

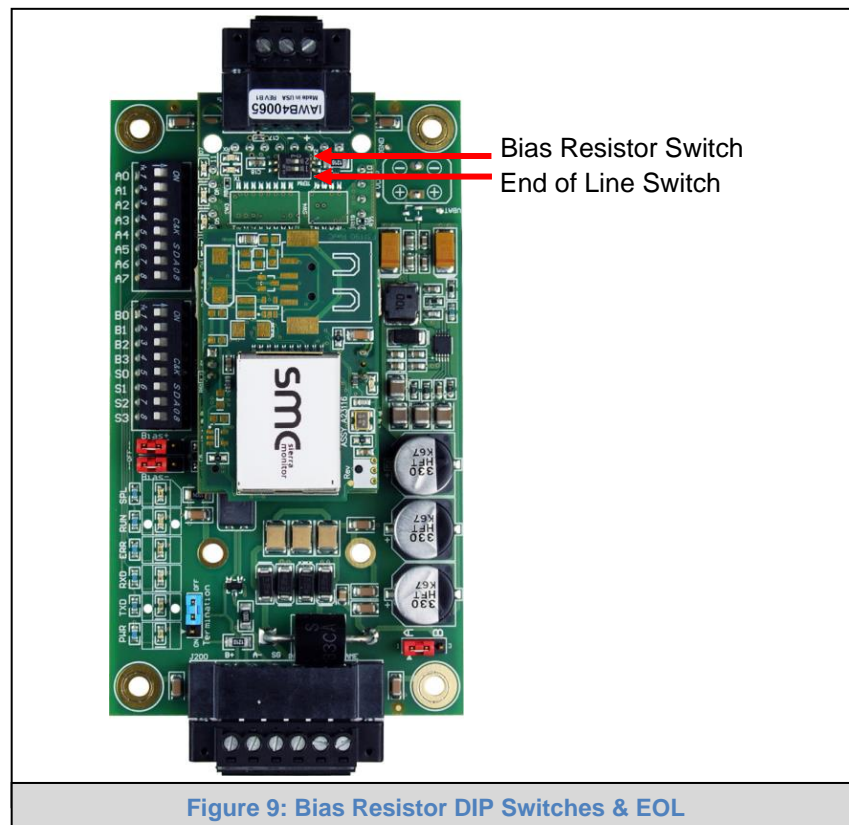

Figure 9: Bias Resistor DIP Switches & EOL

- If more than one RS-485 device is connected to the network, then the field bias resistor switch needs to be enabled to ensure proper communication. See **Figure 9** for the orientation of switch positions referenced below.
 - The default factory setting is OFF (switch position = right side)
 - To enable biasing, turn the bias switch ON (switch position = left side)

NOTE: Biasing only needs to be enabled on one device. The QuickServer has 510-ohm resistors that are used to set the biasing.

- If the FieldServer is the last device on the trunk, then the end of line (EOL) termination switch needs to be enabled. See **Figure 9** for the orientation of switch positions referenced below.
 - The default factory setting is OFF (switch position = right side)
 - To enable the EOL termination, turn the EOL switch ON (switch position = left side)

5 INSTALLING THE QUICKSERVER

5.1 RS-485

5.1.1 RS-485 Connection R2 Port

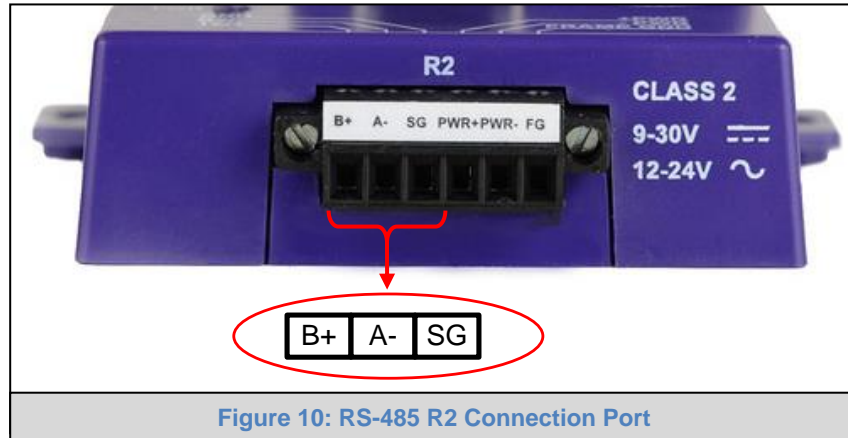

Figure 10: RS-485 R2 Connection Port

Connect to the 3 pins on the left-hand-side of the 6-pin connector as shown.

The following Baud Rates are supported on the R2 Port:
4800, 9600, 19200, 38400, 57600, 115200

For connection details to RS-232 or RS-422, refer to [Appendix A.1](#).

5.1.2 RS-485 Connection R1 Port

NOTE: The following only applies to non-LonWorks QuickServers with an RS-435 R1 port.

Connect to the 3-pin connector as shown.

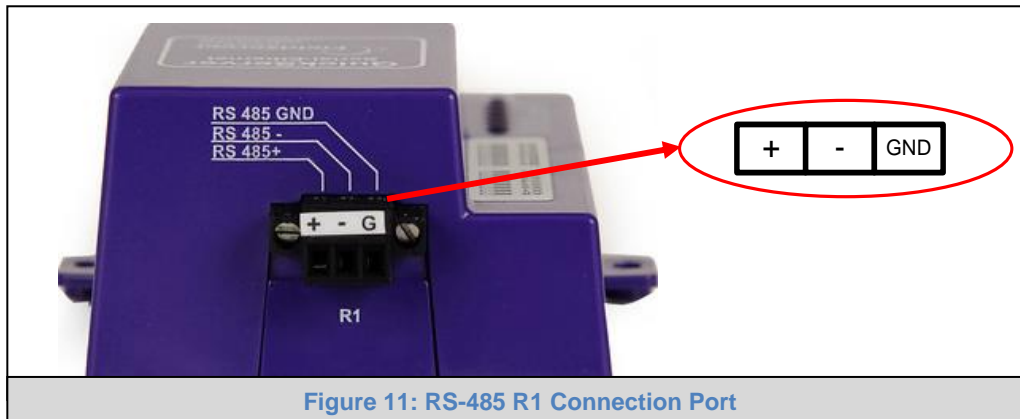

Figure 11: RS-485 R1 Connection Port

The following Baud Rates are supported on the R1 Port:
110, 300, 600, 1200, 2400, 4800, 9600, 19200, 20833, 28800, 38400, 57600, 76800, 115200

5.2 QuickServer LonWorks (FS-QS-1XX1-XXXX)

Connect the QuickServer to the LonWorks terminal using a twisted pair non-shielded cable.



To commission the QuickServer LonWorks port, insert a small screwdriver in the commissioning hole on the face of the QuickServer's enclosure to access the Service Pin. See the instructions on the QuickServer as to which way to toggle the screwdriver during commissioning.

5.3 QuickServer KNX (FS-QS-124X-XXXX)

Connect the QuickServer to the KNX bus using the standard KNX twisted pair cable.

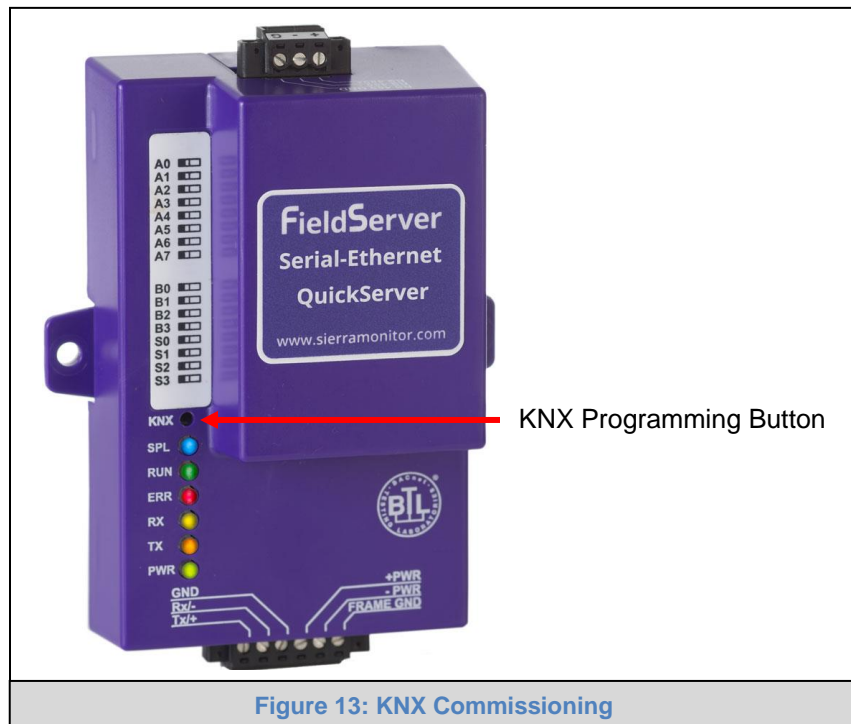

To commission the QuickServer as a KNX device in ETS Software, insert a small pin into the KNX commissioning hole on the face of the QuickServer to access the button.

5.4 RS-232 Connection R2 Port (only available on FS-QS-122X Models)

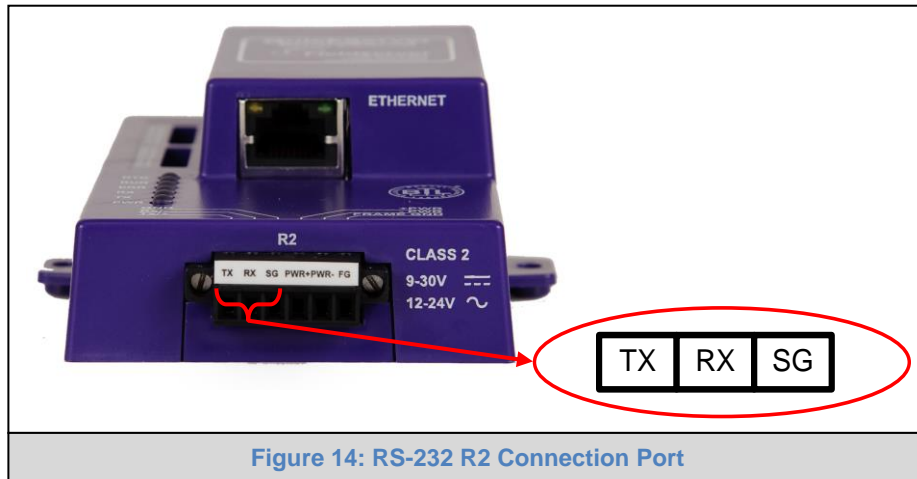

Figure 14: RS-232 R2 Connection Port

Refer to [Appendix A2](#) for further hardware connection options.

The following Baud Rates are supported on the R2 Port:
4800, 9600, 19200, 38400, 57600, 115200

6 OPERATION

6.1 Power Up the Device

Apply power to the device. Ensure that the power supply used complies with the specifications provided. Ensure that the cable is grounded using the "Frame GND" terminal. The QuickServer is factory set for 9-30V DC or 12-24V AC.

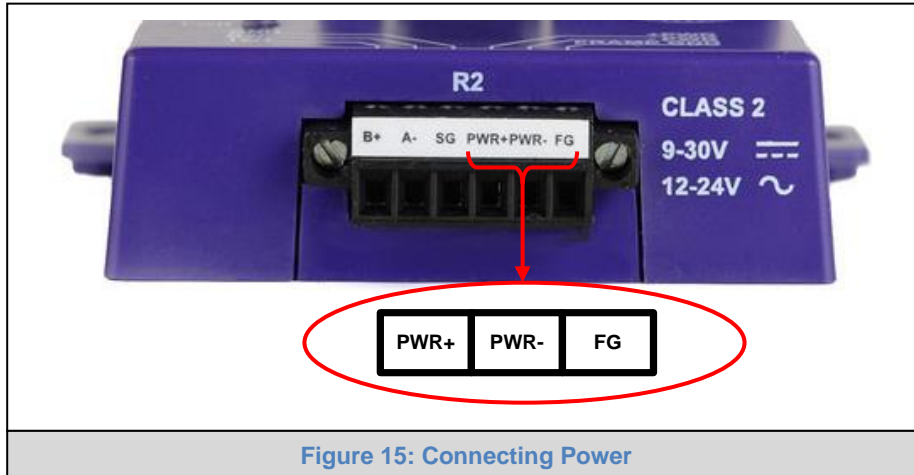

Figure 15: Connecting Power

6.2 Connect the PC to the QuickServer Over the Ethernet Port

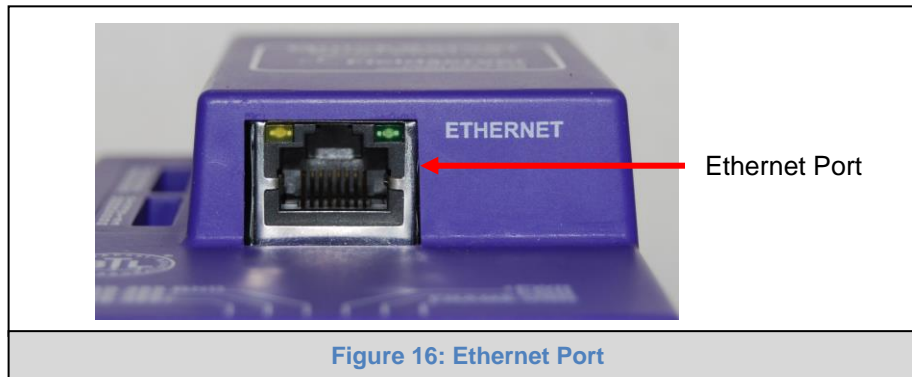

Figure 16: Ethernet Port

- Connect an Ethernet cable between the PC and QuickServer or connect the QuickServer and the PC to the switch using a straight Cat-5 cable.
- The Default IP Address of the QuickServer is **192.168.2.101**, Subnet Mask is **255.255.255.0**.

6.3 Connecting to the QuickServer

6.3.1 Using the FieldServer Toolbox to Discover and Connect to the QuickServer

- Install the Toolbox application from the USB drive or download it from the [Sierra Monitor website](#).
- Use the FS Toolbox application to find the QuickServer and launch the FS-GUI.

NOTE: If the connect button is greyed out, the QuickServer’s IP Address must be set to be on the same network as the PC. (Section 8.1)

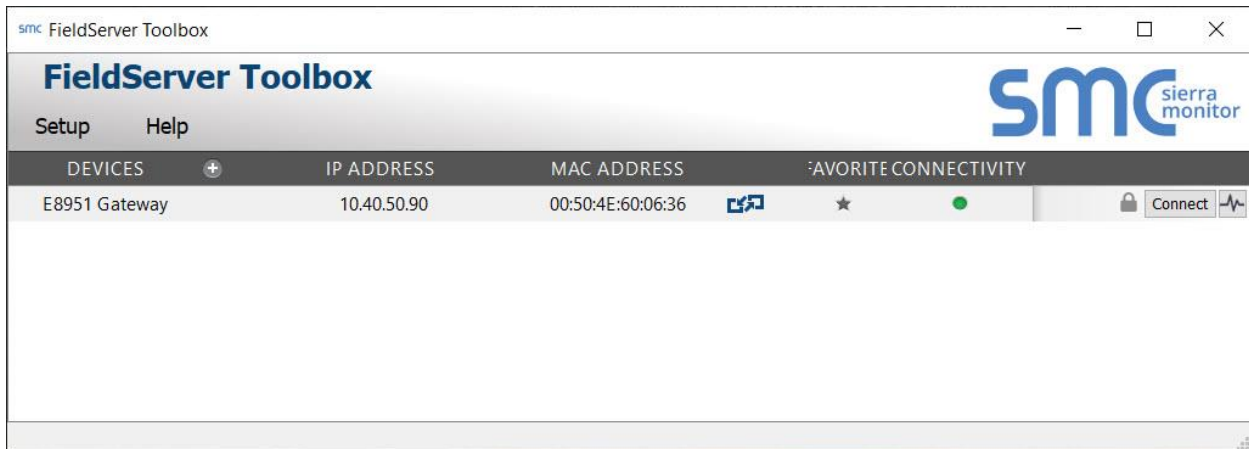

6.3.2 Using a Web Browser to Connect to the QuickServer

- Open a web browser and connect to the QuickServer’s default IP Address. The default IP Address of the FieldServer is **192.168.2.101**, Subnet Mask is **255.255.255.0**.
- If the PC and the QuickServer are on different IP networks, assign a static IP Address to the PC on the 192.168.2.X network.

7 SETUP WEB SERVER SECURITY

7.1 Login to the FieldServer

The first time the FieldServer GUI is opened in a browser, the IP Address for the gateway will appear as untrusted. This will cause the following pop-up windows to appear.

- When the Web Server Security Unconfigured window appears, read the text and choose whether to move forward with HTTPS or HTTP.

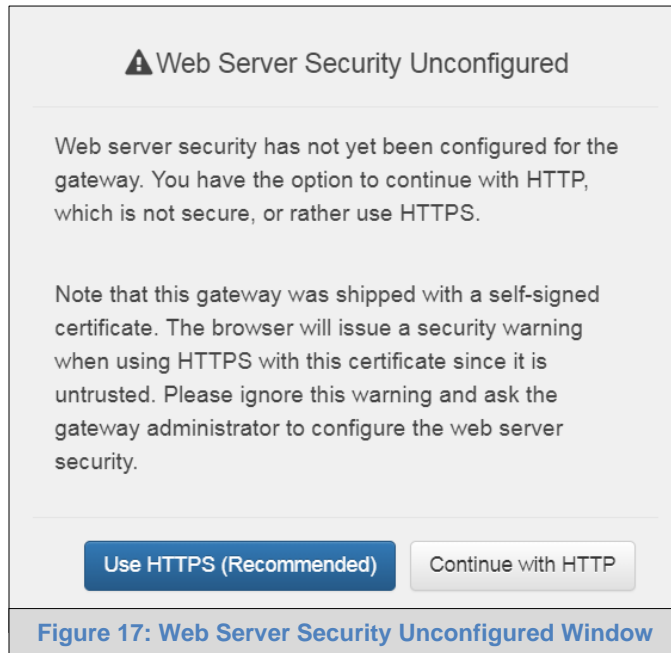

Figure 17: Web Server Security Unconfigured Window

- When the warning that “Your connection is not private” appears, click the advanced button on the bottom left corner of the screen.

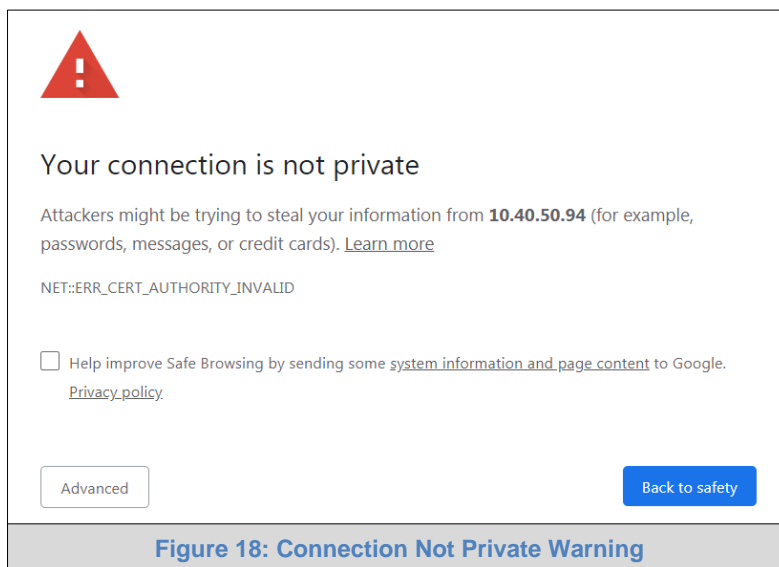

Figure 18: Connection Not Private Warning

- Additional text will expand below the warning, click the underlined text to go to the IP Address. In the **Figure 19** example this text is “[Proceed to 10.40.50.94 \(unsafe\)](#)”.

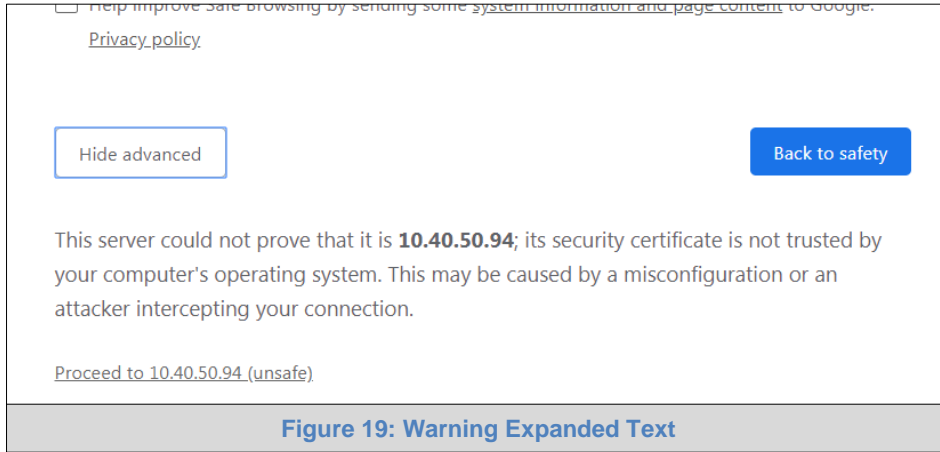

Figure 19: Warning Expanded Text

- When the login screen appears, put in the Username (default is “admin”) and the Password (found on the label of the FieldServer).

NOTE: There is also a QR code in the top right corner of the FieldServer label that shows the default unique password when scanned.

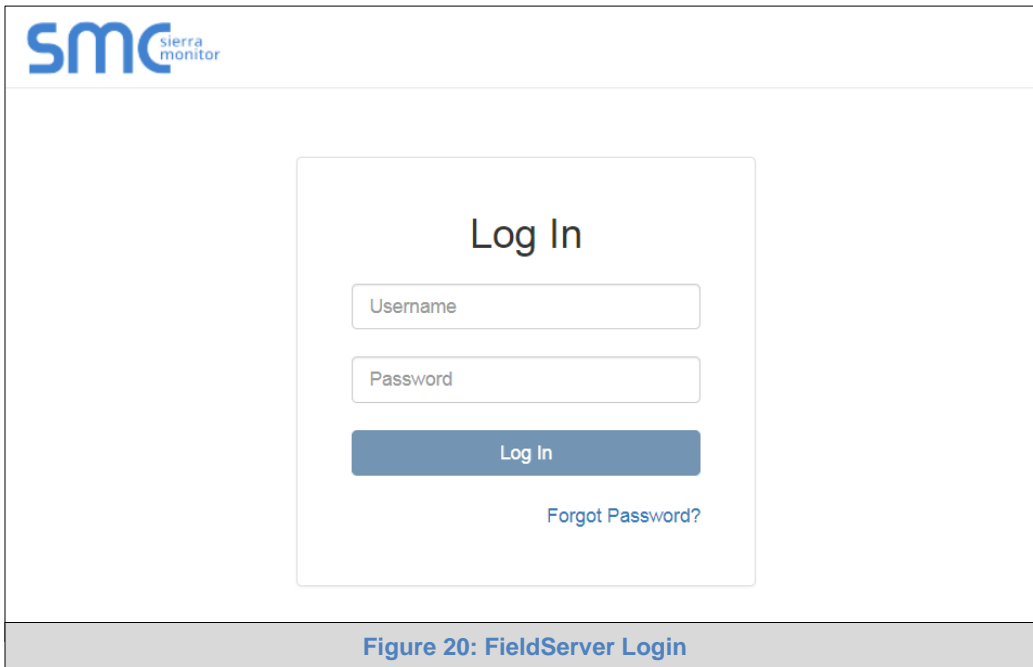

Figure 20: FieldServer Login

NOTE: A user has 5 attempts to login then there will be a 10-minute lockout. There is no timeout on the FieldServer to enter a password.

NOTE: To create individual user logins, go to [Appendix C.5](#).

7.2 Select the Security Mode

- On the first login to the FieldServer, the following screen will appear that allows the user to select which mode the FieldServer should use.

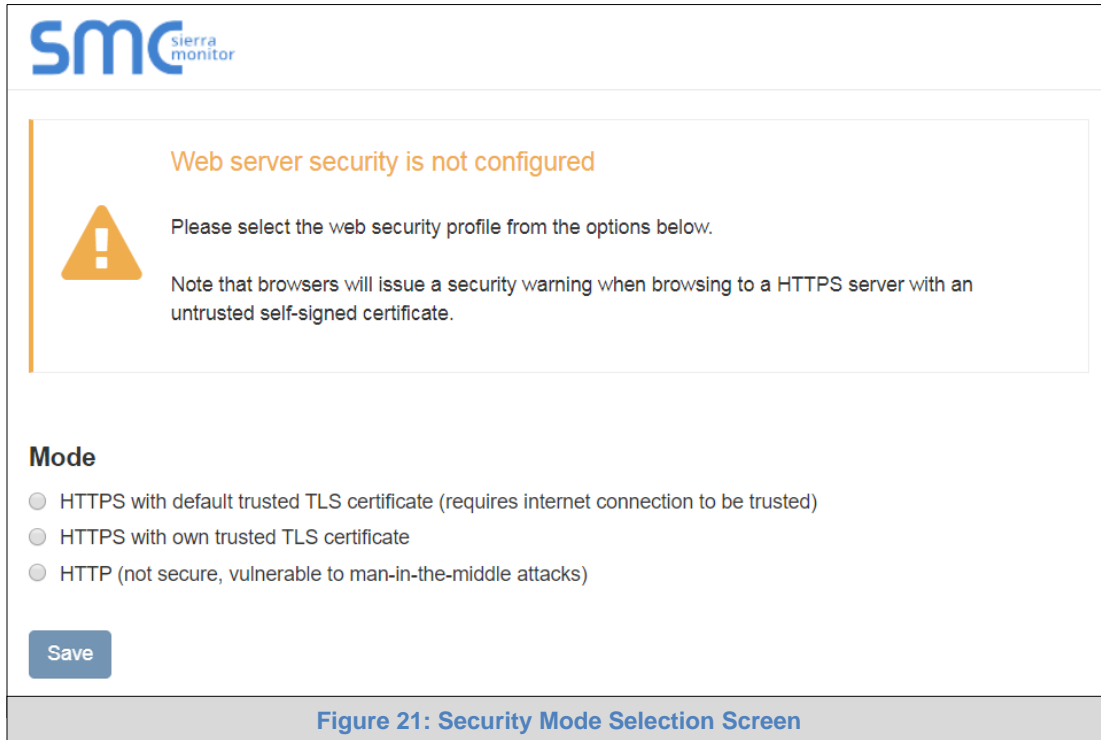

NOTE: Cookies are used for authentication.

NOTE: To change the web server security mode after initial setup, go to [Appendix C.4](#).

The sections that follow include instructions for assigning the different security modes.

7.2.1 HTTPS with Own Trusted TLS Certificate

This is the recommended selection and the most secure.

- Once this option is selected, the Certificate, Private Key and Private Key Passphrase fields will appear under the mode selection.

Certificate

```
XzyMbQZFIRuJZJPe7CTHLcHOrHLowoUFoVTabMYd4d6VGdNkIKazByWKcNOL7mrX
A4lBAQBfM+IPvOx3T/47VEmaiXqE3bx3zEuBFJ6pWPlw7LHf2r2ZoHw+9xb+aNMU
dVvAelhBMTMsnI2ERvQVp0xj3psSv2EJyKXS1bOYNRLsq7UzpwuAdT/Wy3o6vUM5
K+Cwf9qEoQ0LUXDZTIEct67MkcHMiuFi5pk7TRicHnQf/sfoAYOulduHOy9exIk9
FmHFVDIZt/cJUaF+e74EuSph+gEr0IQo2wvmhyc7L22UXse1NoOfU2Zq0Eu1VVtu
JRryaMwIRFEWuuzMGZtKFWVC+8q2JQsVcqiRWM7naoblEhOCMH+sKHJMCxDoXGt
vtZjpZUoAL51YXxWSVcyZdGiAP5e
-----END CERTIFICATE-----
```

Private Key

```
shB0zZoHr4YQSDk2BbYVzbl0LDuKtc8+JiO3ooGjoTuHnqkeAj/fkfbTAsKeAzw
gKQe+H5UQNK0bdvZfOJrm6daDK2vDmR5k+juUHEi5N49upIroB97MQgYotzqfT+
THlbpq5t1SIK617k04ObKmHF5l8fck+ru545sVmpeezh0m5j5SURYAZMvbq5daCu
J4l5NlihbEvxRF4UK41ZDMCvujopC BKUWrb1a/3XXnDnM2K9xyz2wze998D6Wk46
+7aOFY9F+7j5ljmkoS3GYtwCyH5jP+mPP1K6RnuiD019wvGPb4dtN/RTnfd0eF
GYeVskl9fxkxDOFtdWRZbM/rPjn4tmO1Xf8HqONVN1x/iaMynOXG4cukoi4+VO
u0rZaUEsll2zNkfrn7fAASm5NBWg202Cy9IAYnuuis3aAlI5uGBeekA62oTMxlzx
-----END RSA PRIVATE KEY-----
```

Private Key Passphrase

Specify if encrypted

Save

Figure 22: Security Mode Selection Screen

- Copy and paste the Certificate and Private Key text into their respective fields. If the Private Key is encrypted type in the associated Passphrase.
- Click Save.
- A “Redirecting” message will appear. After a short time, the Web Configurator page will open.

7.2.2 HTTPS with Default Untrusted Self-Signed TLS Certificate or HTTP with Built-in Payload Encryption

- Simply select one of these options and click the Save button.
- A “Redirecting” message will appear. After a short time, the Web Configurator page will open.

8 CONFIGURING THE QUICKSERVER

Once the web server setup is complete, the FS-GUI landing page will appear.

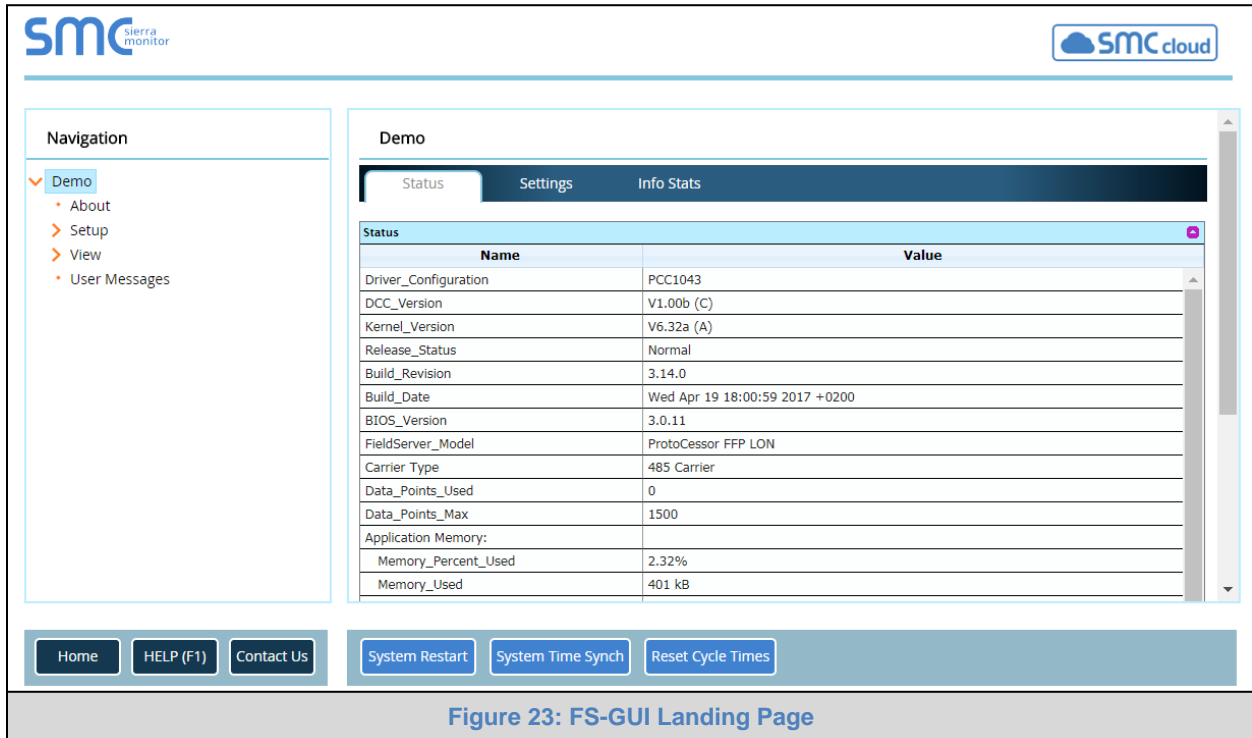



Figure 23: FS-GUI Landing Page

NOTE: The SMC Cloud button  (see [Figure 23](#)) allows users to connect to the SMC Cloud, MSA Safety’s device cloud solution for IIoT. The SMC Cloud enables secure remote connection to field devices through a FieldServer and its local applications for configuration, management, maintenance. For more information about the SMC Cloud, refer to the [SMC Cloud Start-up Guide](#).

8.1 Set IP Address of the QuickServer Using FS-GUI

- From the FS-GUI home page, click on setup and then Network Settings to enter the Edit IP Address Settings menu.
- Modify the IP Address (N1 IP Address field) of the QuickServer Ethernet port.
- If necessary, change the Netmask (N1 Netmask field).
- Type in a new Subnet Mask.
- If necessary, change the IP Gateway (Default Gateway field).
- Type in a new IP Gateway.

NOTE: If the FieldServer is connected to a router, the IP Gateway of the FieldServer should be set to the same IP Address of the router.

- Click Update IP Settings, then click on the System Restart to restart the Gateway and activate the new IP Address.

NOTE: If the FS-GUI was open in a browser, the browser will need to be pointed to the new IP Address of the QuickServer before the FS-GUI will be accessible again.

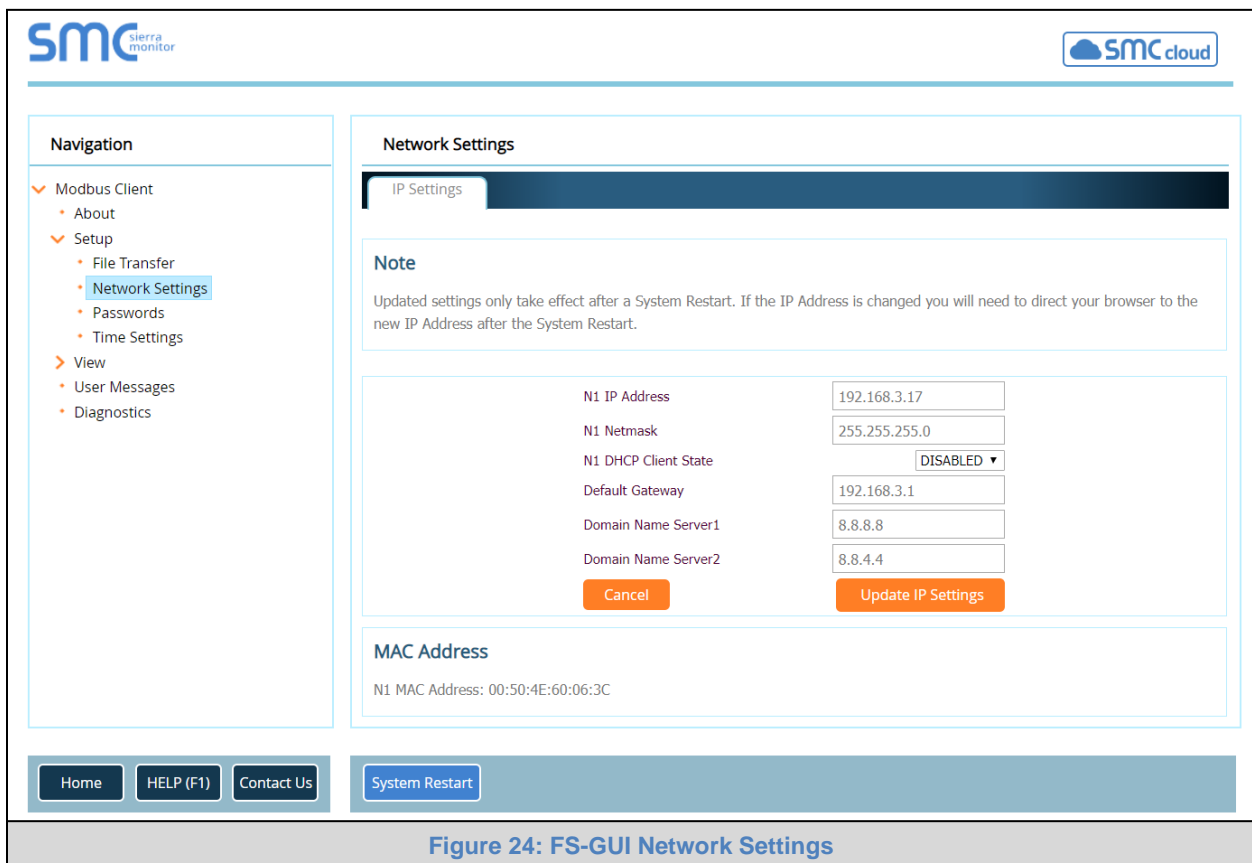

Figure 24: FS-GUI Network Settings

8.2 Retrieve the Sample Configuration File

The configuration of the QuickServer is provided to the QuickServer’s operating system via a comma-delimited file called “CONFIG.CSV”.

If a custom configuration was ordered, the QuickServer will be programmed with the relevant device registers in the Config.csv file for the initial start-up. If not, the product is shipped with a sample config.csv that shows an example of the drivers ordered.

- In the main menu of the FS-GUI screen, go to “Setup”, then “File Transfer”, and finally “Retrieve”.
- Click on “config.csv”, and open or save the file.

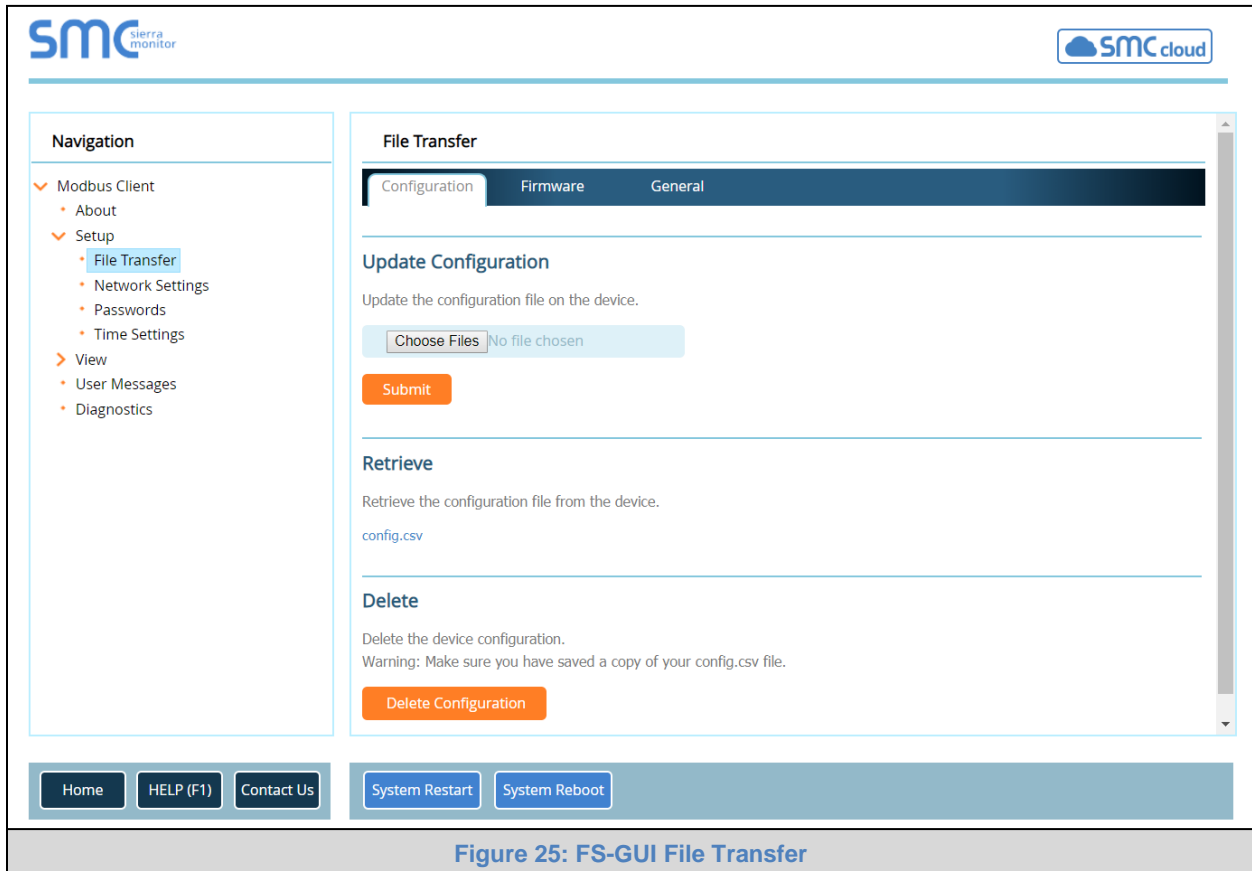

Figure 25: FS-GUI File Transfer

8.3 Change the Configuration File to Meet the Application

Refer to the FieldServer Configuration Manual in conjunction with the Driver supplements for information on configuring the QuickServer.

8.4 Load the Updated Configuration File

8.4.1 Using the FS-GUI to Load a Configuration File

- In the main menu of the FS-GUI screen, click “Setup”, then “File Transfer” and finally “Update”.
- Browse and select the .csv file, open, then click “Submit”.

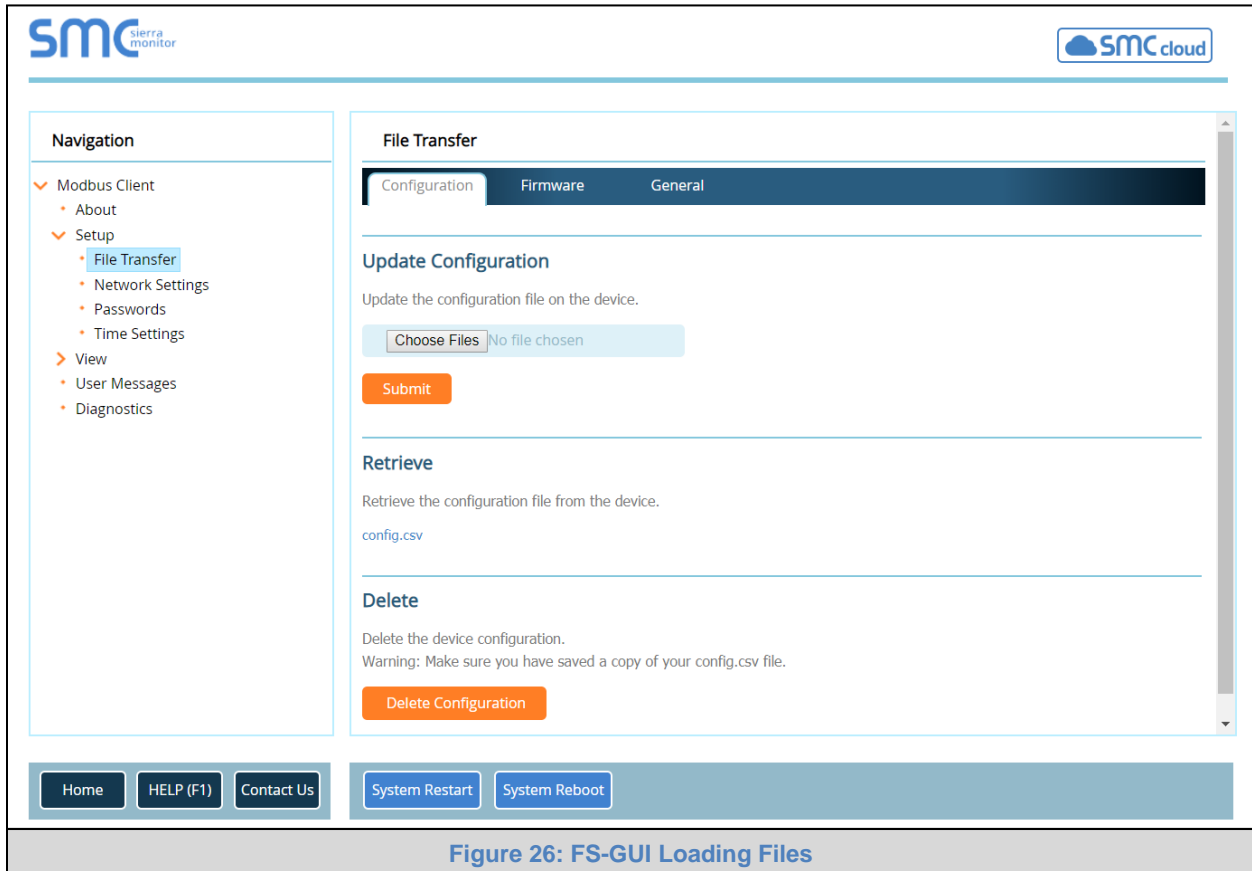

Figure 26: FS-GUI Loading Files

- Once download is complete, a message bar will appear confirming that the configuration was updated successfully.
- Click the System Restart Button to put the new file into operation.

NOTE: It is possible to do multiple downloads to the QuickServer before resetting it.

8.4.2 Retrieve the Configuration File for Modification or Backup

To get a copy of the configuration file for modifying or backing up a configuration on a local computer, do the following:

- In the main menu of the FS-GUI screen, click “Setup”, then “File Transfer”.

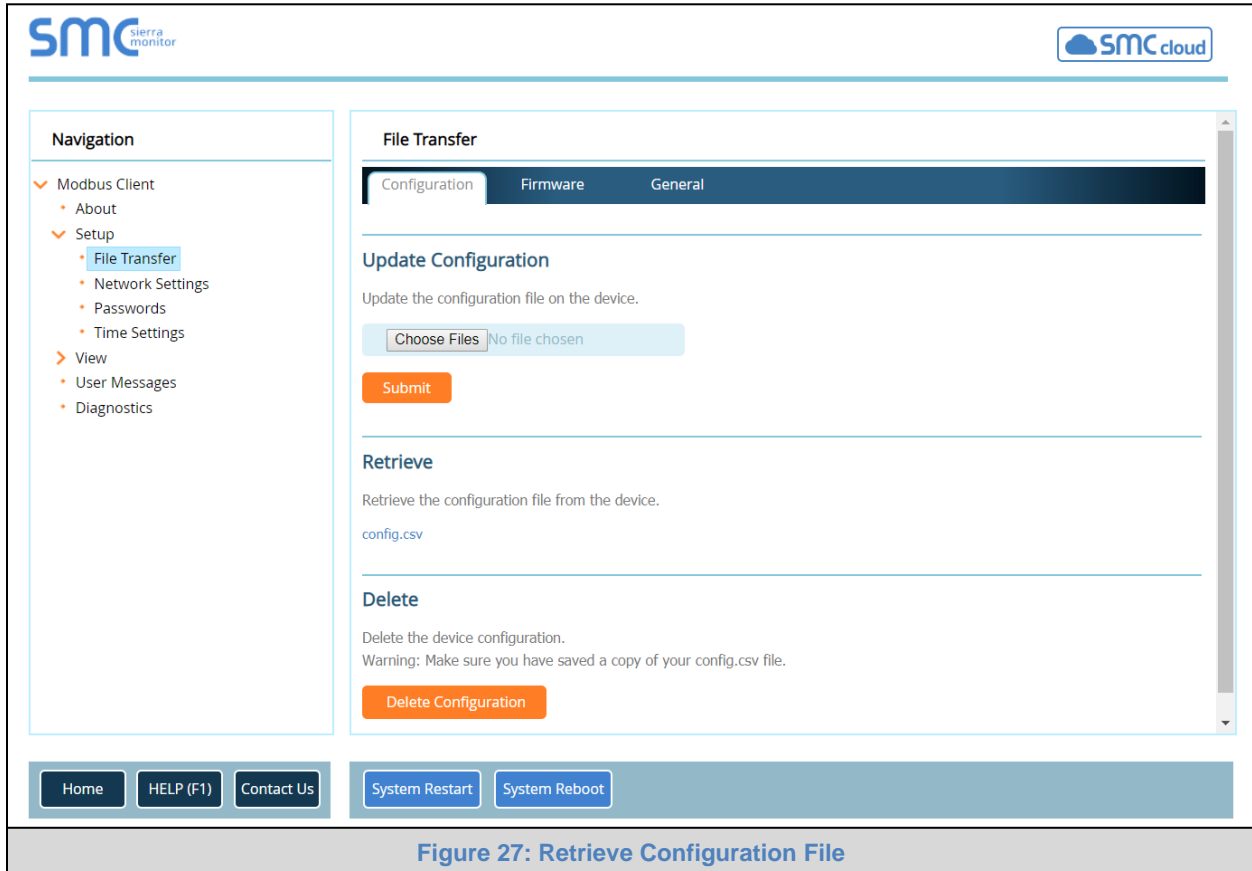

Figure 27: Retrieve Configuration File

- Click the “config.csv” link under the “Retrieve” heading in the middle section of the screen.
 - The file will automatically download to the web browser’s default download location.
- Edit or store the file as desired.

NOTE: Before using any backup configuration file to reset the configuration settings, check that the backup file is not an old version.

8.5 Test and Commission the QuickServer

- Connect the QuickServer to the third-party device(s) and test the application.
- From the landing page of the FS-GUI click on “View” in the navigation tree, then “Connections” to see the number of messages on each protocol.

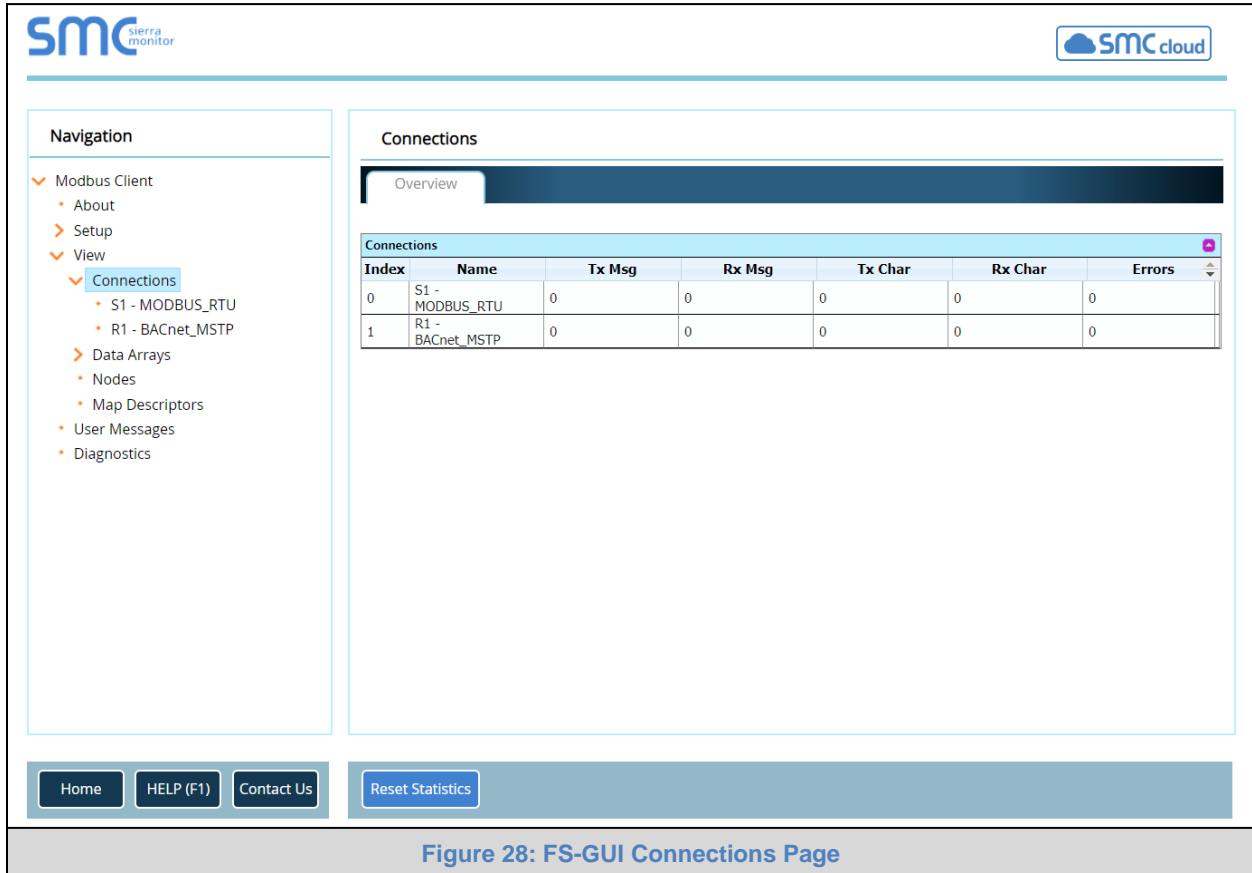

Figure 28: FS-GUI Connections Page

8.5.1 Accessing SMC Cloud

The SMC Cloud button (see Figure 23) allows users to connect to the SMC Cloud, MSA Safety’s device cloud solution for IIoT. The SMC Cloud enables secure remote connection to field devices through a FieldServer and its local applications for configuration, management, maintenance. For more information about the SMC Cloud, refer to the [SMC Cloud Start-up Guide](#).

APPENDIX A USEFUL FEATURES

Appendix A.1. RS-422 Connection R2 Port

NOTE: The following only applies to models: FS-QS-1230 and FS-QS-1231.

RS-422 is a full duplex multi-drop multi-master differential bus. It can be wired to conform to a RS-485 network when less wiring/cabling is used (due to being less expensive to install), but then it becomes a half-duplex multi-drop multi-master differential bus. RS-422 is used for dedicated peer to peer high speed communication when low bus latency is required (very few devices on the bus). Its usage is very specific to client installations/requirements.

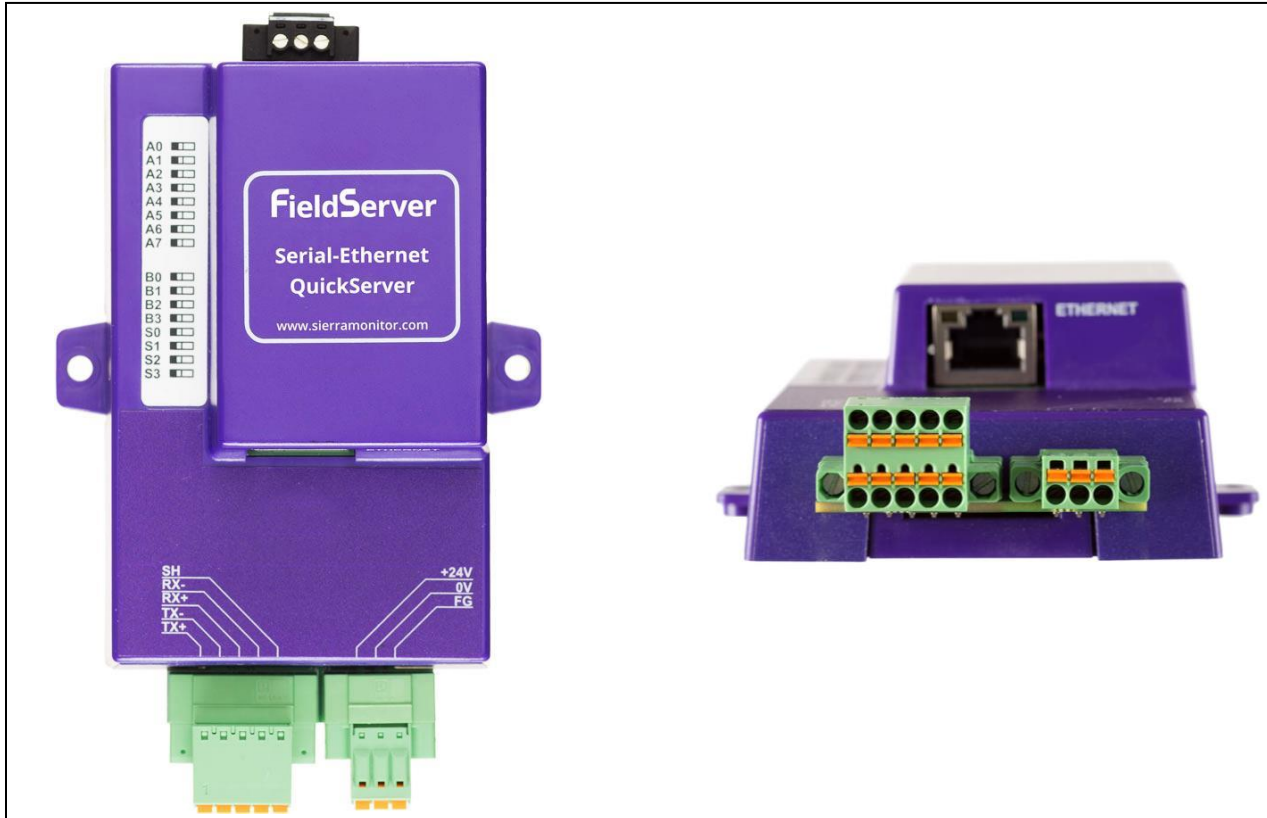
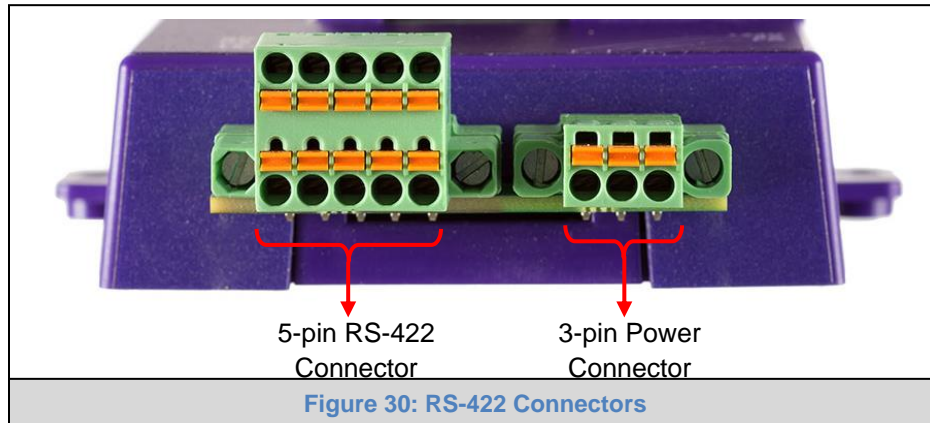

Figure 29: RS-422 Unit

NOTE:

- The RS-232 looks similar to the RS-485 but does not have the blue jumper. The blue jumper is used to enable the termination resistor for the RX signals (120 ohms), while the red jumpers are used to enable the bias resistors for RX signals (510 ohms). In the case of Rockwell/Tetrapak, all jumpers are always required to be in default position (not enabled). For other clients, the bias resistors should always be in the “on” state.
- The part number on the back of the box will identify the port.

Appendix A.1.1. Connection and Operation via the RS-422 Port



RS-422 Connector

- Pin 1-2:* TX +/- (Differential TX outputs: All + signals must be connected to each other, and same applies to - signals; no +/- signals may be crossed)
- Pin 3-4:* RX +/- (Differential RX inputs: All + signals must be connected to each other, and same applies to - signals; no +/- signals may be crossed)
- Pin 5:* SHD (Shield connection, must be connected on at least one side of the bus, but not necessarily on both sides)

POWER Connector

Please note that AC voltage is not supported on the RS-422 carrier, and that DC voltage range is ~20VDC to ~28VDC.

- Pin 1:* +24V (DC power requires this pin be used for the positive voltage)
- Pin 2:* 0V (DC power requires this pin is used for ground / return voltage)
- Pin 3:* FG (this pin needs to be connected to EARTH or noise free reference point - CHASSIS)

Appendix A.2. KNX Connection R2 Port

NOTE: The following only applies to models: FS-QS-1240 and FS-QS-1241.

The KNX QuickServer is used to transfer data to and from devices using KNX protocol. The KNX driver enables data access from KNX networks to other FieldServer protocols. Most KNX data-point types are supported, allowing communication to almost any kind of KNX device in an installation, such as temperature sensors, shutters, light switches, actuators, alarms, etc. This allows BMS systems to access a KNX network using direct read and write or with KNX configured groups. This setup does not require the use of ETS4 to configure the QuickServer KNX gateway. The KNX protocol is a connectionless protocol and therefore supports multiple clients and multiple servers. The QuickServer is intended to act as a Passive Client on the KNX bus and makes information available to other protocols.

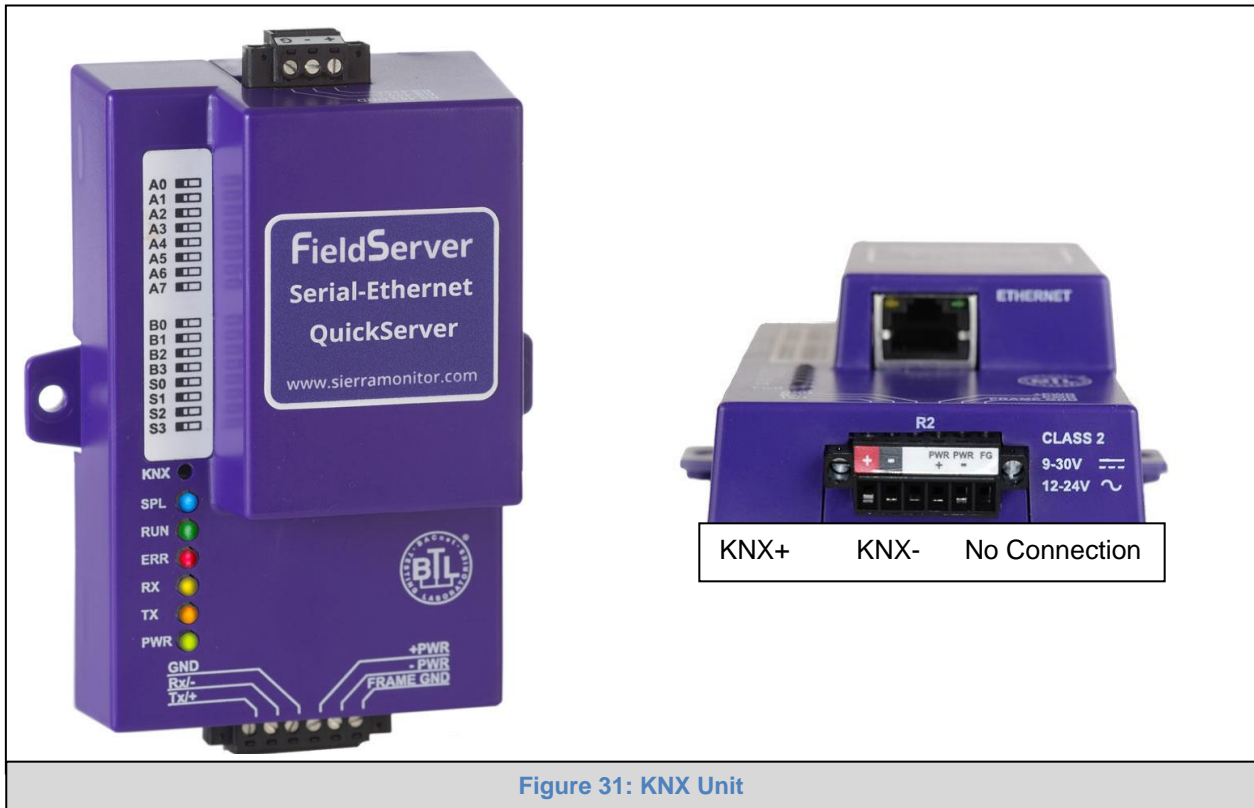

Figure 31: KNX Unit

The KNX Connector consist of a KNX + and KNX- terminal. Each terminal corresponds to the red KNX+ and gray KNX- bus connections on a KNX bus.

The following Baud Rates are supported on the R2 Port:
4800, 9600, 19200, 38400, 57600, 115200

Appendix A.3. M-Bus Connection R2 Port

NOTE: The following only applies to models: FS-QS-1A50, FS-QS-1A51, FS-QS-1B50, FS-QS-1B51, FS-QS-1C50 and FS-QS-1C51.

The M-Bus driver allows the FieldServer to transfer data to and from devices using M-Bus protocol. The Fieldbus connection is included with the FieldServer. The M-Bus QuickServer Gateway is configurable to act as both a Master and a Slave M-Bus device.

The M-Bus Connector consist of a + and – terminal. Most M-Bus Devices are not polarity sensitive, although the polarity of the M-Bus Connector is indicated on the device diagram, should it be a requirement. The M-Bus devices to communicate with the FieldServer must be configured according to the manufacturer’s instructions (for example primary address and readout data).

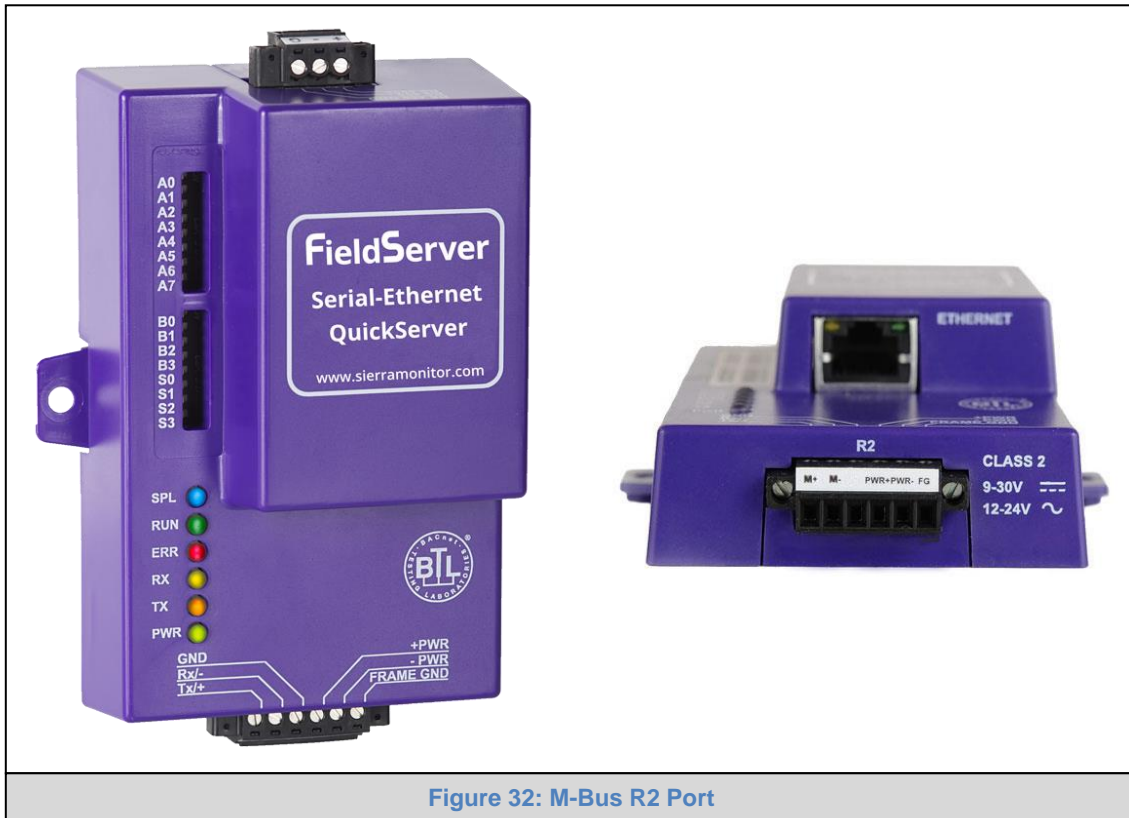

Figure 32: M-Bus R2 Port

The following baud rates are supported on the R2 Port:
 300, 600, 1200, 2400, 4800, 9600, 19200, 38400

Appendix A.4. SSL/TLS for Secure Connection

SSL/TLS (Secure Sockets Layer/Transport Layer Security) is a security technology for establishing an encrypted connection between a server and a client. This allows the secure transfer of data across untrusted networks.

These functions are supported on the following:

FS-QS-1011 or **FS-QS-1211** with a serial number starting with 15 or later (indicating the year it shipped).

Minimum BIOS requirement: 2.6.1

Appendix A.4.1. Configuring FieldServer as a SSL/TLS Server

The following example sets the FieldServer to accept a secure Modbus/TCP connection on port 1502.

Appendix A.4.1.1. Simple Secure Server Configuration

Add TLS_Port parameter in the connections section of the configuration file and set to a port number between 1 – 65535.

```
Connections
Adapter , Protocol , TLS_Port
N1 , Modbus/TCP , 1502
```

This configuration sets the FieldServer to accept any incoming connection but will not request a client's certificate for verification. This means that the FieldServer end point communication will be encrypted but not authenticated.

The FieldServer will send an embedded self-signed certificate if one is requested by a connecting client.

NOTE: If a remote client requires a certificate, then request the smc_cert.pem certificate from FieldServer Technical Support and update the remote client's authority as per vendor instructions.

Appendix A.4.1.2. Limiting Client Access

In addition to TLS_Port parameter also add Validate_Client_Cert in the connections section of the configuration file and set it to “Yes”.

Connections				
Adapter	Protocol	TLS_Port	Validate_Client_Cert	
N1	Modbus/TCP	1502	Yes	

The configuration above sets the FieldServer to request and verify a client’s certificate against its internal authority file before accepting connection. By default, this means the FieldServer will only accept connections from other FieldServers.

In order to load an authority file so that the FieldServer will accept connections from a chosen list of remote clients, configure the FieldServer with the following connection settings:

Connections					
Adapter	Protocol	TLS_Port	Validate_Client_Cert	Cert_Authority_File	
N1	Modbus/TCP	1502	Yes	my_authorized_clients.pem	

This configuration has the FieldServer accept connections from clients who have the correct certificate. The authority file is a collection of client certificates in PEM format. This file can be edited using any text file editor.

NOTE: Cert_Authority_File is useful only if Validate_Client_Cert is set to ‘Yes’.

Appendix A.4.1.3. To Upload the Authority File to the FieldServer

1. Enter the IP address of the FieldServer into a web browser.
2. Choose the ‘Setup’ option in the Navigation Tree and Select ‘File Transfer’.
3. Choose the ‘General’ tab.
4. Click on the ‘Browse’ button and select the PEM file you want to upload.
5. Click on ‘Submit’.
6. When the message, “The file was uploaded successfully” appears, click on the ‘System Restart’ button.

Appendix A.4.1.4. Certificate Validation Options

If connections must be limited to only a particular domain (vendor devices), include Check_Remote_Host to specify the domain/host name.

```
Connections
Adapter , Protocol , TLS_Port , Validate_Client_Cert , Cert_Authority_File , Check_Remote_Host
N1 , Modbus/TCP , 1502 , Yes , my_authorized_clients.pem , SMC
```

The configuration above tells the FieldServer to only accept connections that have the correct certification and is coming from the specified host.

The Check_Remote_Host value is synonymously known as common name, host name or domain etc. The common name can be obtained by the following methods:

- Ask the certificate issuer for the host name.
- Use online tools to decode the certificate (for example: <https://www.sslshopper.com/certificate-decoder.html>).
- If the program openssl is installed on the local PC, then run the following command to get the common name: `openssl x509 -in certificate.pem -text -noout`

Appendix A.4.1.5. Set up Server Certificate

Make sure the certificate is in PEM format. Otherwise, convert it to PEM format (reference the link below). support.ssl.com/Knowledgebase/Article

Configure the FieldServer to use a custom certificate as shown below:

```
Connections
Adapter , Protocol , TLS_Port , Server_Cert_File
N1 , Modbus/TCP , 1502 , my_server_cert.pem
```

Appendix A.4.2. Configuring FieldServer as SSL/TLS Client

The following Node configurations set the FieldServer to open a secure Modbus/TCP connection to Server at IP Address 10.11.12.13 on port 1502.

Appendix A.4.2.1. Simple Secure Client Configuration

Add Remote_Node_TLS_Port parameter in the nodes section of the configuration file and set to a port number between 1 – 65535.

```
Nodes
Node_Name , Node_ID , Protocol , Adapter , IP_Address , Remote_Node_TLS_Port
PLC_11 , 11 , Modbus/TCP , N1 , 10.11.12.13 , 1502
```

The above configuration sets the FieldServer to connect to a remote server but does not request a server's certificate for verification. This means that the FieldServer end point communication will be encrypted but not authenticated.

If requested by a remote server, the FieldServer will send an embedded self-signed certificate.

Appendix A.4.2.2. Limit Server Access

Add the Validate_Server_Cert parameter to the client node section of the configuration.

```
..... , Remote_Node_TLS_Port , Validate_Server_Cert
..... , 1502 , Yes
```

The above configuration sets the FieldServer to request and verify the server's certificate against its own internal authority file before finalizing the connection. By default, this means the FieldServer will only establish connections to other FieldServers.

```
..... , Remote_Node_TLS_Port , Validate_Server_Cert , Cert_Authority_File
..... , 1502 , Yes , my_authorized_servers.pem
```

The above configuration sets the FieldServer to use a specified PEM file to allow custom server connections.

The authority file is a collection of server certificates in PEM format. This file can be edited using any text file editor (such as notepad). When the file has all required certificates, paste it into the PEM formatted server certificate. Now the FieldServer will connect to a server if it can find the server's certificate in the authority file.

NOTE: Cert_Authority_File is useful only if Validate_Client_Cert is set to 'Yes'.

To upload the Certificate to the FieldServer follow the directions for the authority file in [Appendix A.4.1.3](#).

Appendix A.4.2.3. Certificate Validation Options

Use the Check_Remote_Host element as described in [Appendix A.4.1.4](#).

Appendix A.4.2.4. Set up Client Certificate

Make sure the certificate is in PEM format. Otherwise, convert it to PEM format (reference the link below). support.ssl.com/Knowledgebase/Article

Configure the FieldServer to use a custom certificate as shown below:

```
..... , Client_Cert_File
..... , my_client_cert.pem
```

APPENDIX B VENDOR INFORMATION – M-BUS DATA PROFILES

NOTE: All points are Float Data Type. The first Modbus register contains the least significant word.

Appendix B.1. Aquametro Calec ST Mappings to BACnet and Modbus

Point Name	BACnet	Modbus
Vol_Flo_1	AI 01	30001-30002
Temp_Flo_1	AI 02	30003-30004
Temp_Ret_1	AI 03	30005-30006
Temp_Diff_1	AI 04	30007-30008
Power_W_1	AI 05	30009-30010
Energy_Wh_1	AI 06	30011-30012
Energy_Wh_2	AI 07	30013-30014
Volume_1	AI 08	30015-30016
Volume_2	AI 09	30017-30018
Time_1	AI 10	30019-30020
Time_2	AI 11	30021-30022
Mass_1	AI 12	30023-30024
Time_P_1	AI 13	30025-30026
Time_P_2	AI 14	30027-30028
Time_P_3	AI 15	30029-30030
Unknown_1	AI 16	30031-30032
Unknown_2	AI 17	30033-30034
Unknown_3	AI 18	30035-30036
Unknown_4	AI 19	30037-30038
Unknown_5	AI 20	30039-30040
Unknown_6	AI 21	30041-30042
Unknown_7	AI 22	30043-30044
Unknown_8	AI 23	30045-30046
Unknown_9	AI 24	30047-30048

Appendix B.4. EMU 3PH Power 3-85 Mappings to BACnet and Modbus

Point Name	BACnet	Modbus
MBUS_Meter_ \$node_id_Alarms	AI 01	30001-30002
Energy_WH_1	AI 02	30003-30004
Energy_WH_2	AI 03	30005-30006
Energy_WH_3	AI 04	30007-30008
Voltage_1	AI 05	30009-30010
Voltage_2	AI 06	30011-30012
Voltage_3	AI 07	30013-30014
Current_1	AI 08	30015-30016
Current_2	AI 09	30017-30018
Current_3	AI 10	30019-30020

Appendix B.5. Kamstrup 601 Mappings to BACnet and Modbus

Point Name	BACnet	Modbus
Energy_T_WH_1	AI 01	30001-30002
Energy_T_WH_2	AI 02	30003-30004
Energy_T_WH_3	AI 03	30005-30006
Energy_T_WH_4	AI 04	30007-30008
Energy_T_WH_5	AI 05	30009-30010
Energy_T_WH_6	AI 06	30011-30012
Energy_T_WH_7	AI 07	30013-30014
Energy_T_WH_8	AI 08	30015-30016
Energy_T_WH_9	AI 09	30017-30018
Energy_T_WH_10	AI 10	30019-30020
Temp_Flow_1	AI 11	30021-30022
Temp_Flow_2	AI 12	30023-30024
Temp_Flow_3	AI 13	30025-30026
Temp_Ret_1	AI 14	30027-30028
Temp_Ret_2	AI 15	30029-30030
Temp_Ret_3	AI 16	30031-30032
Temp_Dif_1	AI 17	30033-30034
Temp_Dif_2	AI 18	30035-30036
Temp_Dif_3	AI 19	30037-30038
Time_Hrs_1	AI 20	30039-30040
Time_Hrs_2	AI 21	30041-30042
Time_Hrs_3	AI 22	30043-30044
Power_W_1	AI 23	30045-30046
Power_W_2	AI 24	30047-30048
Power_W_3	AI 25	30049-30050
Power_W_4	AI 26	30051-30052
Power_W_5	AI 27	30053-30054
Power_W_6	AI 28	30055-30056
Power_W_7	AI 29	30057-30058
Power_W_8	AI 30	30059-30060
Power_W_9	AI 31	30061-30062
Vol_Flo_L_H_1	AI 32	30063-30064
Vol_Flo_L_H_2	AI 33	30065-30066
Vol_Flo_L_H_3	AI 34	30067-30068
Vol_Flo_L_H_4	AI 35	30069-30070
Vol_Flo_L_H_5	AI 36	30071-30072
Vol_Flo_L_H_6	AI 37	30073-30074
Vol_Flo_L_H_7	AI 38	30075-30076
Vol_Flo_L_H_8	AI 39	30077-30078

Appendix B.2. Comet XRM-50 Mappings to BACnet and Modbus

Point Name	BACnet	Modbus
MBUS_Meter_ \$node_id_Alarms	AI 01	30001-30002
Volume	AI 02	30003-30004
Time_stamp	AI 03	30005-30006
Error_Flags	AI 04	30007-30008
M_BUS_STATE	AI 05	30009-30010

Appendix B.3. Elvaco CMA20 Mappings to BACnet and Modbus

Point Name	BACnet	Modbus
MBUS_Meter_ \$node_id_Alarms	AI 01	30001-30002
Temp_Inst	AI 02	30003-30004
Temp_Min	AI 03	30005-30006
Temp_Max	AI 04	30007-30008
Temp_Avg	AI 05	30009-30010
RH_Ins	AI 06	30011-30012
RH_Min	AI 07	30013-30014
RH_Max	AI 08	30015-30016
RH_Avg	AI 09	30017-30018

Vol_Flo_L_H_9	AI 40	30079-30080
Volume_1	AI 41	30081-30082
Volume_2	AI 42	30083-30084
Volume_3	AI 43	30085-30086
Volume_4	AI 44	30087-30088
Volume_5	AI 45	30089-30090
Volume_6	AI 46	30091-30092
Volume_7	AI 47	30093-30094
Volume_8	AI 48	30095-30096
Volume_9	AI 49	30097-30098
Volume_10	AI 50	30099-30100
Time_Point_1	AI 51	30101-30102
Time_Point_2	AI 52	30103-30104
Time_Point_3	AI 53	30105-30106
Time_Point_4	AI 54	30107-30108
Time_Point_5	AI 55	30109-30110
Time_Point_6	AI 56	30111-30112
ID_Num_1	AI 57	30113-30114
ID_Num_2	AI 58	30115-30116
ID_Num_3	AI 59	30117-30118

Vol_Flo_L_H_7	AI 42	30083-30084
Vol_Flo_L_H_8	AI 43	30085-30086
Vol_Flo_L_H_9	AI 44	30087-30088
Vol_Flo_L_H_10	AI 45	30089-30090
Volume_1	AI 46	30091-30092
Volume_2	AI 47	30093-30094
Volume_3	AI 48	30095-30096
Volume_4	AI 49	30097-30098
Volume_5	AI 50	30099-30100
Volume_6	AI 51	30101-30102
Volume_7	AI 52	30103-30104
Volume_8	AI 53	30105-30106
Volume_9	AI 54	30107-30108
Volume_10	AI 55	30109-30110
Time_Point_1	AI 56	30111-30112
Time_Point_2	AI 57	30113-30114
Time_Point_3	AI 58	30115-30116
Time_Point_4	AI 59	30117-30118
Time_Point_5	AI 60	30119-30120
Time_Point_6	AI 61	30121-30122
ID_Num_1	AI 62	30123-30124
ID_Num_2	AI 63	30125-30126
ID_Num_3	AI 64	30127-30128

Appendix B.6. Kamstrup 602 Mappings to BACnet and Modbus

Point Name	BACnet	Modbus
Energy_T_WH_1	AI 01	30001-30002
Energy_T_WH_2	AI 02	30003-30004
Energy_T_WH_3	AI 03	30005-30006
Energy_T_WH_4	AI 04	30007-30008
Energy_T_WH_5	AI 05	30009-30010
Energy_T_WH_6	AI 06	30011-30012
Energy_T_WH_7	AI 07	30013-30014
Energy_T_WH_8	AI 08	30015-30016
Energy_T_WH_9	AI 09	30017-30018
Energy_T_WH_10	AI 10	30019-30020
Temp_Flow_1	AI 11	30021-30022
Temp_Flow_2	AI 12	30023-30024
Temp_Flow_3	AI 13	30025-30026
Temp_Ret_1	AI 14	30027-30028
Temp_Ret_2	AI 15	30029-30030
Temp_Ret_3	AI 16	30031-30032
Temp_Dif_1	AI 17	30033-30034
Temp_Dif_2	AI 18	30035-30036
Temp_Dif_3	AI 19	30037-30038
Temp_Dif_4	AI 20	30039-30040
Temp_Dif_5	AI 21	30041-30042
Temp_Dif_6	AI 22	30043-30044
Time_Hrs_1	AI 23	30045-30046
Time_Hrs_2	AI 24	30047-30048
Time_Hrs_3	AI 25	30049-30050
Power_W_1	AI 26	30051-30052
Power_W_2	AI 27	30053-30054
Power_W_3	AI 28	30055-30056
Power_W_4	AI 29	30057-30058
Power_W_5	AI 30	30059-30060
Power_W_6	AI 31	30061-30062
Power_W_7	AI 32	30063-30064
Power_W_8	AI 33	30065-30066
Power_W_9	AI 34	30067-30068
Power_W_10	AI 35	30069-30070
Vol_Flo_L_H_1	AI 36	30071-30072
Vol_Flo_L_H_2	AI 37	30073-30074
Vol_Flo_L_H_3	AI 38	30075-30076
Vol_Flo_L_H_4	AI 39	30077-30078
Vol_Flo_L_H_5	AI 40	30079-30080
Vol_Flo_L_H_6	AI 41	30081-30082

Appendix B.7. Sontay Zenner Multidata Mappings to BACnet and Modbus

Point Name	BACnet	Modbus
ID_1	AI 01	30001-30002
Energy_WH_1	AI 02	30003-30004
Volume_1	AI 03	30005-30006
Volume_2	AI 04	30007-30008
Error_Flags	AI 05	30009-30010
Energy_WH_2	AI 06	30011-30012
Volume_3	AI 07	30013-30014
Volume_4	AI 08	30015-30016
Volume_5	AI 09	30017-30018
Vol_Flow_1	AI 10	30019-30020
Power_W_1	AI 11	30021-30022
Temp_Flow	AI 12	30023-30024
Temp_Return	AI 13	30025-30026
Energy_WH_5	AI 14	30027-30028
Energy_WH_6	AI 15	30029-30030
Energy_WH_7	AI 16	30031-30032
Energy_WH_8	AI 17	30033-30034
Energy_WH_9	AI 18	30035-30036
Energy_WH_10	AI 19	30037-30038

Appendix B.8. Sontex SuperCal 531 Mappings to BACnet and Modbus

Point Name	BACnet	Modbus
Dur_Avg_S_1	AI 01	30001-30002
Dur_Avg_M_1	AI 02	30003-30004
Energy_T_WH_1	AI 03	30005-30006
Energy_T_WH_2	AI 04	30007-30008
Energy_T_WH_3	AI 05	30009-30010
Energy_T_WH_4	AI 06	30011-30012
Energy_T_WH_5	AI 07	30013-30014
Energy_T_WH_6	AI 08	30015-30016
Energy_T_WH_7	AI 09	30017-30018
Energy_T_WH_8	AI 10	30019-30020
Energy_T_WH_9	AI 11	30021-30022

Energy_T_WH_10	AI 12	30023-30024
Temp_Flow_1	AI 13	30025-30026
Temp_Ret_1	AI 14	30027-30028
Time_Hrs_1	AI 15	30029-30030
Vol_Flo_L_S_1	AI 16	30031-30032
Error_Flags_1	AI 17	30033-30034
Medium_1	AI 18	30035-30036
Medium_2	AI 19	30037-30038
Volume_1	AI 20	30039-30040

Appendix B.9. Siemens WFH21 Mappings to BACnet and Modbus

Point Name	BACnet	Modbus
Energy_T_WH_1	AI 01	30001-30002
Time_Hrs_1	AI 02	30003-30004
Power_Jh_1	AI 03	30005-30006
ID_1	AI 04	30007-30008
Volume_1	AI 05	30009-30010
Volume_2	AI 06	30011-30012
Unknown_1	AI 07	30013-30014
Unknown_2	AI 08	30015-30016
Unknown_3	AI 09	30017-30018
Unknown_4	AI 10	30019-30020

Appendix B.10. Siemens FUE950 Energy Mappings to BACnet and Modbus

Point Name	BACnet	Modbus
Energy 1	AI 01	30001-30002
Energy 2	AI 02	30003-30004
Energy 3	AI 03	30005-30006
Energy 4	AI 04	30007-30008
Temp Flow	AI 05	30009-30010
Temp Ret	AI 06	30011-30012
Temp Dif	AI 07	30013-30014
Time Op Days	AI 08	30015-30016
Time Point 1	AI 09	30017-30018
Time Point 2	AI 10	30019-30020
Power	AI 11	30021-30022
Volume Flow	AI 12	30023-30024
Volume 1	AI 13	30025-30026
Volume 2	AI 14	30027-30028
Volume 3	AI 15	30029-30030
Volume 4	AI 16	30031-30032
Firmware	AI 17	30033-30034
Software	AI 18	30035-30036
Access Code	AI 19	30037-30038

Appendix B.11. QS All Data Profile Mappings to BACnet and Modbus

Point Name	BACnet	Modbus
Dur_Avg_S_1	AI 1	30001-30002
Dur_Avg_S_2	AI 2	30003-30004
Dur_Avg_S_3	AI 3	30005-30006
Dur_Avg_S_4	AI 4	30007-30008
Dur_Avg_S_5	AI 5	30009-30010
Dur_Avg_S_6	AI 6	30011-30012
Dur_Avg_S_7	AI 7	30013-30014

Dur_Avg_S_8	AI 8	30015-30016
Dur_Avg_S_9	AI 9	30017-30018
Dur_Avg_S_10	AI 10	30019-30020
Dur_Avg_M_1	AI 11	30021-30022
Dur_Avg_M_2	AI 12	30023-30024
Dur_Avg_M_3	AI 13	30025-30026
Dur_Avg_M_4	AI 14	30027-30028
Dur_Avg_M_5	AI 15	30029-30030
Dur_Avg_M_6	AI 16	30031-30032
Dur_Avg_M_7	AI 17	30033-30034
Dur_Avg_M_8	AI 18	30035-30036
Dur_Avg_M_9	AI 19	30037-30038
Dur_Avg_M_10	AI 20	30039-30040
Dur_Avg_H_1	AI 21	30041-30042
Dur_Avg_H_2	AI 22	30043-30044
Dur_Avg_H_3	AI 23	30045-30046
Dur_Avg_H_4	AI 24	30047-30048
Dur_Avg_H_5	AI 25	30049-30050
Dur_Avg_H_6	AI 26	30051-30052
Dur_Avg_H_7	AI 27	30053-30054
Dur_Avg_H_8	AI 28	30055-30056
Dur_Avg_H_9	AI 29	30057-30058
Dur_Avg_H_10	AI 30	30059-30060
Dur_Avg_D_1	AI 31	30061-30062
Dur_Avg_D_2	AI 32	30063-30064
Dur_Avg_D_3	AI 33	30065-30066
Dur_Avg_D_4	AI 34	30067-30068
Dur_Avg_D_5	AI 35	30069-30070
Dur_Avg_D_6	AI 36	30071-30072
Dur_Avg_D_7	AI 37	30073-30074
Dur_Avg_D_8	AI 38	30075-30076
Dur_Avg_D_9	AI 39	30077-30078
Dur_Avg_D_10	AI 40	30079-30080
Dur_Act_Sec_1	AI 41	30081-30082
Dur_Act_Sec_2	AI 42	30083-30084
Dur_Act_Sec_3	AI 43	30085-30086
Dur_Act_Sec_4	AI 44	30087-30088
Dur_Act_Sec_5	AI 45	30089-30090
Dur_Act_Sec_6	AI 46	30091-30092
Dur_Act_Sec_7	AI 47	30093-30094
Dur_Act_Sec_8	AI 48	30095-30096
Dur_Act_Sec_9	AI 49	30097-30098
Dur_Act_Sec_10	AI 50	30099-30100
Dur_Act_Min_1	AI 51	30101-30102
Dur_Act_Min_2	AI 52	30103-30104
Dur_Act_Min_3	AI 53	30105-30106
Dur_Act_Min_4	AI 54	30107-30108
Dur_Act_Min_5	AI 55	30109-30110
Dur_Act_Min_6	AI 56	30111-30112
Dur_Act_Min_7	AI 57	30113-30114
Dur_Act_Min_8	AI 58	30115-30116
Dur_Act_Min_9	AI 59	30117-30118
Dur_Act_Min_10	AI 60	30119-30120
Dur_Act_Hrs_1	AI 61	30121-30122
Dur_Act_Hrs_2	AI 62	30123-30124
Dur_Act_Hrs_3	AI 63	30125-30126
Dur_Act_Hrs_4	AI 64	30127-30128
Dur_Act_Hrs_5	AI 65	30129-30130
Dur_Act_Hrs_6	AI 66	30131-30132
Dur_Act_Hrs_7	AI 67	30133-30134
Dur_Act_Hrs_8	AI 68	30135-30136
Dur_Act_Hrs_9	AI 69	30137-30138
Dur_Act_Hrs_10	AI 70	30139-30140
Dur_Act_Day_1	AI 71	30141-30142
Dur_Act_Day_2	AI 72	30143-30144
Dur_Act_Day_3	AI 73	30145-30146
Dur_Act_Day_4	AI 74	30147-30148
Dur_Act_Day_5	AI 75	30149-30150
Dur_Act_Day_6	AI 76	30151-30152

Dur_Act_Day_7	AI 77	30153-30154
Dur_Act_Day_8	AI 78	30155-30156
Dur_Act_Day_9	AI 79	30157-30158
Dur_Act_Day_10	AI 80	30159-30160
Energy_T_WH_1	AI 81	30161-30162
Energy_T_WH_2	AI 82	30163-30164
Energy_T_WH_3	AI 83	30165-30166
Energy_T_WH_4	AI 84	30167-30168
Energy_T_WH_5	AI 85	30169-30170
Energy_T_WH_6	AI 86	30171-30172
Energy_T_WH_7	AI 87	30173-30174
Energy_T_WH_8	AI 88	30175-30176
Energy_T_WH_9	AI 89	30177-30178
Energy_T_WH_10	AI 90	30179-30180
Energy_T_J_1	AI 91	30181-30182
Energy_T_J_2	AI 92	30183-30184
Energy_T_J_3	AI 93	30185-30186
Energy_T_J_4	AI 94	30187-30188
Energy_T_J_5	AI 95	30189-30190
Energy_T_J_6	AI 96	30191-30192
Energy_T_J_7	AI 97	30193-30194
Energy_T_J_8	AI 98	30195-30196
Energy_T_J_9	AI 99	30197-30198
Energy_T_J_10	AI 100	30199-30200
Voltage_1	AI 101	30201-30202
Voltage_2	AI 102	30203-30204
Voltage_3	AI 103	30205-30206
Voltage_4	AI 104	30207-30208
Voltage_5	AI 105	30209-30210
Voltage_6	AI 106	30211-30212
Voltage_7	AI 107	30213-30214
Voltage_8	AI 108	30215-30216
Voltage_9	AI 109	30217-30218
Voltage_10	AI 110	30219-30220
Current_1	AI 111	30221-30222
Current_2	AI 112	30223-30224
Current_3	AI 113	30225-30226
Current_4	AI 114	30227-30228
Current_5	AI 115	30229-30230
Current_6	AI 116	30231-30232
Current_7	AI 117	30233-30234
Current_8	AI 118	30235-30236
Current_9	AI 119	30237-30238
Current_10	AI 120	30239-30240
Temp_Ext_1	AI 121	30241-30242
Temp_Ext_2	AI 122	30243-30244
Temp_Ext_3	AI 123	30245-30246
Temp_Ext_4	AI 124	30247-30248
Temp_Ext_5	AI 125	30249-30250
Temp_Ext_6	AI 126	30251-30252
Temp_Ext_7	AI 127	30253-30254
Temp_Ext_8	AI 128	30255-30256
Temp_Ext_9	AI 129	30257-30258
Temp_Ext_10	AI 130	30259-30260
Temp_Flow_1	AI 131	30261-30262
Temp_Flow_2	AI 132	30263-30264
Temp_Flow_3	AI 133	30265-30266
Temp_Flow_4	AI 134	30267-30268
Temp_Flow_5	AI 135	30269-30270
Temp_Flow_6	AI 136	30271-30272
Temp_Flow_7	AI 137	30273-30274
Temp_Flow_8	AI 138	30275-30276
Temp_Flow_9	AI 139	30277-30278
Temp_Flow_10	AI 140	30279-30280
Temp_Ret_1	AI 141	30281-30282
Temp_Ret_2	AI 142	30283-30284
Temp_Ret_3	AI 143	30285-30286
Temp_Ret_4	AI 144	30287-30288
Temp_Ret_5	AI 145	30289-30290

Temp_Ret_6	AI 146	30291-30292
Temp_Ret_7	AI 147	30293-30294
Temp_Ret_8	AI 148	30295-30296
Temp_Ret_9	AI 149	30297-30298
Temp_Ret_10	AI 150	30299-30300
Temp_Dif_1	AI 151	30301-30302
Temp_Dif_2	AI 152	30303-30304
Temp_Dif_3	AI 153	30305-30306
Temp_Dif_4	AI 154	30307-30308
Temp_Dif_5	AI 155	30309-30310
Temp_Dif_6	AI 156	30311-30312
Temp_Dif_7	AI 157	30313-30314
Temp_Dif_8	AI 158	30315-30316
Temp_Dif_9	AI 159	30317-30318
Temp_Dif_10	AI 160	30319-30320
Time_Sec_1	AI 161	30321-30322
Time_Sec_2	AI 162	30323-30324
Time_Sec_3	AI 163	30325-30326
Time_Sec_4	AI 164	30327-30328
Time_Sec_5	AI 165	30329-30330
Time_Sec_6	AI 166	30331-30332
Time_Sec_7	AI 167	30333-30334
Time_Sec_8	AI 168	30335-30336
Time_Sec_9	AI 169	30337-30338
Time_Sec_10	AI 170	30339-30340
Time_Min_1	AI 171	30341-30342
Time_Min_2	AI 172	30343-30344
Time_Min_3	AI 173	30345-30346
Time_Min_4	AI 174	30347-30348
Time_Min_5	AI 175	30349-30350
Time_Min_6	AI 176	30351-30352
Time_Min_7	AI 177	30353-30354
Time_Min_8	AI 178	30355-30356
Time_Min_9	AI 179	30357-30358
Time_Min_10	AI 180	30359-30360
Time_Hrs_1	AI 181	30361-30362
Time_Hrs_2	AI 182	30363-30364
Time_Hrs_3	AI 183	30365-30366
Time_Hrs_4	AI 184	30367-30368
Time_Hrs_5	AI 185	30369-30370
Time_Hrs_6	AI 186	30371-30372
Time_Hrs_7	AI 187	30373-30374
Time_Hrs_8	AI 188	30375-30376
Time_Hrs_9	AI 189	30377-30378
Time_Hrs_10	AI 190	30379-30380
Time_Days_1	AI 191	30381-30382
Time_Days_2	AI 192	30383-30384
Time_Days_3	AI 193	30385-30386
Time_Days_4	AI 194	30387-30388
Time_Days_5	AI 195	30389-30390
Time_Days_6	AI 196	30391-30392
Time_Days_7	AI 197	30393-30394
Time_Days_8	AI 198	30395-30396
Time_Days_9	AI 199	30397-30398
Time_Days_10	AI 200	30399-30400
Time_Op_Sec_1	AI 201	30401-30402
Time_Op_Sec_2	AI 202	30403-30404
Time_Op_Sec_3	AI 203	30405-30406
Time_Op_Sec_4	AI 204	30407-30408
Time_Op_Sec_5	AI 205	30409-30410
Time_Op_Sec_6	AI 206	30411-30412
Time_Op_Sec_7	AI 207	30413-30414
Time_Op_Sec_8	AI 208	30415-30416
Time_Op_Sec_9	AI 209	30417-30418
Time_Op_Sec_10	AI 210	30419-30420
Time_Op_Min_1	AI 211	30421-30422
Time_Op_Min_2	AI 212	30423-30424
Time_Op_Min_3	AI 213	30425-30426
Time_Op_Min_4	AI 214	30427-30428

Time_Op_Min_5	AI 215	30429-30430
Time_Op_Min_6	AI 216	30431-30432
Time_Op_Min_7	AI 217	30433-30434
Time_Op_Min_8	AI 218	30435-30436
Time_Op_Min_9	AI 219	30437-30438
Time_Op_Min_10	AI 220	30439-30440
Time_Op_Hrs_1	AI 221	30441-30442
Time_Op_Hrs_2	AI 222	30443-30444
Time_Op_Hrs_3	AI 223	30445-30446
Time_Op_Hrs_4	AI 224	30447-30448
Time_Op_Hrs_5	AI 225	30449-30450
Time_Op_Hrs_6	AI 226	30451-30452
Time_Op_Hrs_7	AI 227	30453-30454
Time_Op_Hrs_8	AI 228	30455-30456
Time_Op_Hrs_9	AI 229	30457-30458
Time_Op_Hrs_10	AI 230	30459-30460
Time_Op_Days_1	AI 231	30461-30462
Time_Op_Days_2	AI 232	30463-30464
Time_Op_Days_3	AI 233	30465-30466
Time_Op_Days_4	AI 234	30467-30468
Time_Op_Days_5	AI 235	30469-30470
Time_Op_Days_6	AI 236	30471-30472
Time_Op_Days_7	AI 237	30473-30474
Time_Op_Days_8	AI 238	30475-30476
Time_Op_Days_9	AI 239	30477-30478
Time_Op_Days_10	AI 240	30479-30480
Custom_1	AI 241	30481-30482
Custom_2	AI 242	30483-30484
Custom_3	AI 243	30485-30486
Custom_4	AI 244	30487-30488
Custom_5	AI 245	30489-30490
Custom_6	AI 246	30491-30492
Custom_7	AI 247	30493-30494
Custom_8	AI 248	30495-30496
Custom_9	AI 249	30497-30498
Custom_10	AI 250	30499-30500
Power_W_1	AI 251	30501-30502
Power_W_2	AI 252	30503-30504
Power_W_3	AI 253	30505-30506
Power_W_4	AI 254	30507-30508
Power_W_5	AI 255	30509-30510
Power_W_6	AI 256	30511-30512
Power_W_7	AI 257	30513-30514
Power_W_8	AI 258	30515-30516
Power_W_9	AI 259	30517-30518
Power_W_10	AI 260	30519-30520
Power_Jh_1	AI 261	30521-30522
Power_Jh_2	AI 262	30523-30524
Power_Jh_3	AI 263	30525-30526
Power_Jh_4	AI 264	30527-30528
Power_Jh_5	AI 265	30529-30530
Power_Jh_6	AI 266	30531-30532
Power_Jh_7	AI 267	30533-30534
Power_Jh_8	AI 268	30535-30536
Power_Jh_9	AI 269	30537-30538
Power_Jh_10	AI 270	30539-30540
Pressure_1	AI 271	30541-30542
Pressure_2	AI 272	30543-30544
Pressure_3	AI 273	30545-30546
Pressure_4	AI 274	30547-30548
Pressure_5	AI 275	30549-30550
Pressure_6	AI 276	30551-30552
Pressure_7	AI 277	30553-30554
Pressure_8	AI 278	30555-30556
Pressure_9	AI 279	30557-30558
Pressure_10	AI 280	30559-30560
Mass_1	AI 281	30561-30562
Mass_2	AI 282	30563-30564
Mass_3	AI 283	30565-30566

Mass_4	AI 284	30567-30568
Mass_5	AI 285	30569-30570
Mass_6	AI 286	30571-30572
Mass_7	AI 287	30573-30574
Mass_8	AI 288	30575-30576
Mass_9	AI 289	30577-30578
Mass_10	AI 290	30579-30580
Mass_Flow_1	AI 291	30581-30582
Mass_Flow_2	AI 292	30583-30584
Mass_Flow_3	AI 293	30585-30586
Mass_Flow_4	AI 294	30587-30588
Mass_Flow_5	AI 295	30589-30590
Mass_Flow_6	AI 296	30591-30592
Mass_Flow_7	AI 297	30593-30594
Mass_Flow_8	AI 298	30595-30596
Mass_Flow_9	AI 299	30597-30598
Mass_Flow_10	AI 300	30599-30600
Vol_Flo_L_M_1	AI 301	30601-30602
Vol_Flo_L_M_2	AI 302	30603-30604
Vol_Flo_L_M_3	AI 303	30605-30606
Vol_Flo_L_M_4	AI 304	30607-30608
Vol_Flo_L_M_5	AI 305	30609-30610
Vol_Flo_L_M_6	AI 306	30611-30612
Vol_Flo_L_M_7	AI 307	30613-30614
Vol_Flo_L_M_8	AI 308	30615-30616
Vol_Flo_L_M_9	AI 309	30617-30618
Vol_Flo_L_M_10	AI 310	30619-30620
Vol_Flo_L_H_1	AI 311	30621-30622
Vol_Flo_L_H_2	AI 312	30623-30624
Vol_Flo_L_H_3	AI 313	30625-30626
Vol_Flo_L_H_4	AI 314	30627-30628
Vol_Flo_L_H_5	AI 315	30629-30630
Vol_Flo_L_H_6	AI 316	30631-30632
Vol_Flo_L_H_7	AI 317	30633-30634
Vol_Flo_L_H_8	AI 318	30635-30636
Vol_Flo_L_H_9	AI 319	30637-30638
Vol_Flo_L_H_10	AI 320	30639-30640
Vol_Flo_ML_S_1	AI 321	30641-30642
Vol_Flo_ML_S_2	AI 322	30643-30644
Vol_Flo_ML_S_3	AI 323	30645-30646
Vol_Flo_ML_S_4	AI 324	30647-30648
Vol_Flo_ML_S_5	AI 325	30649-30650
Vol_Flo_ML_S_6	AI 326	30651-30652
Vol_Flo_ML_S_7	AI 327	30653-30654
Vol_Flo_ML_S_8	AI 328	30655-30656
Vol_Flo_ML_S_9	AI 329	30657-30658
Vol_Flo_ML_S_10	AI 330	30659-30660
ID_1	AI 331	30661-30662
ID_2	AI 332	30663-30664
ID_3	AI 333	30665-30666
ID_4	AI 334	30667-30668
ID_5	AI 335	30669-30670
ID_6	AI 336	30671-30672
ID_7	AI 337	30673-30674
ID_8	AI 338	30675-30676
ID_9	AI 339	30677-30678
ID_10	AI 340	30679-30680
Volume_1	AI 341	30681-30682
Volume_2	AI 342	30683-30684
Volume_3	AI 343	30685-30686
Volume_4	AI 344	30687-30688
Volume_5	AI 345	30689-30690
Volume_6	AI 346	30691-30692
Volume_7	AI 347	30693-30694
Volume_8	AI 348	30695-30696
Volume_9	AI 349	30697-30698
Volume_10	AI 350	30699-30700
Error_Flags_1	AI 351	30701-30702
Error_Flags_2	AI 352	30703-30704

Error_Flags_3	AI 353	30705-30706
Error_Flags_4	AI 354	30707-30708
Error_Flags_5	AI 355	30709-30710
Error_Flags_6	AI 356	30711-30712
Error_Flags_7	AI 357	30713-30714
Error_Flags_8	AI 358	30715-30716
Error_Flags_9	AI 359	30717-30718
Error_Flags_10	AI 360	30719-30720
Medium_1	AI 361	30721-30722
Medium_2	AI 362	30723-30724
Medium_3	AI 363	30725-30726
Medium_4	AI 364	30727-30728
Medium_5	AI 365	30729-30730
Medium_6	AI 366	30731-30732
Medium_7	AI 367	30733-30734
Medium_8	AI 368	30735-30736
Medium_9	AI 369	30737-30738
Medium_10	AI 370	30739-30740
Unknown_1	AI 371	30741-30742
Unknown_2	AI 372	30743-30744
Unknown_3	AI 373	30745-30746
Unknown_4	AI 374	30747-30748
Unknown_5	AI 375	30749-30750
Unknown_6	AI 376	30751-30752
Unknown_7	AI 377	30753-30754
Unknown_8	AI 378	30755-30756
Unknown_9	AI 379	30757-30758
Unknown_10	AI 380	30759-30760
Time_Pt_1	AI 381	30761-30762
Time_Pt_2	AI 382	30763-30764
Time_Pt_3	AI 383	30765-30766
Time_Pt_4	AI 384	30767-30768
Time_Pt_5	AI 385	30769-30770
Time_Pt_6	AI 386	30771-30772
Time_Pt_7	AI 387	30773-30774
Time_Pt_8	AI 388	30775-30776
Time_Pt_9	AI 389	30777-30778
Time_Pt_10	AI 390	30779-30780
Fab_Number_1	AI 391	30781-30782
Fab_Number_2	AI 392	30783-30784
Fab_Number_3	AI 393	30785-30786
Fab_Number_4	AI 394	30787-30788
Fab_Number_5	AI 395	30789-30790
Fab_Number_6	AI 396	30791-30792
Fab_Number_7	AI 397	30793-30794
Fab_Number_8	AI 398	30795-30796
Fab_Number_9	AI 399	30797-30798
Fab_Number_10	AI 400	30799-30800
Alarm_Flags_1	AI 401	30801-30802
Alarm_Flags_2	AI 402	30803-30804
Alarm_Flags_3	AI 403	30805-30806
Alarm_Flags_4	AI 404	30807-30808
Alarm_Flags_5	AI 405	30809-30810
Alarm_Flags_6	AI 406	30811-30812
Alarm_Flags_7	AI 407	30813-30814
Alarm_Flags_8	AI 408	30815-30816
Alarm_Flags_9	AI 409	30817-30818
Alarm_Flags_10	AI 410	30819-30820

Appendix B.12. Kamstrup 66 Mappings to BACnet and Modbus

Point Name	BACnet	Modbus
Energy_T_WH_1	AI 01	30001-30002
Energy_T_WH_2	AI 02	30003-30004
Energy_T_WH_3	AI 03	30005-30006

Energy_T_WH_4	AI 04	30007-30008
Energy_T_WH_5	AI 05	30009-30010
Energy_T_WH_6	AI 06	30011-30012
Energy_T_WH_7	AI 07	30013-30014
Energy_T_WH_8	AI 08	30015-30016
Energy_T_WH_9	AI 09	30017-30018
Energy_T_WH_10	AI 10	30019-30020
Energy_T_J_1	AI 11	30021-30022
Temp_Ret_1	AI 12	30023-30024
Temp_Dif_1	AI 13	30025-30026
Time_Hrs_1	AI 14	30027-30028
Power_W_1	AI 15	30029-30030
Power_W_2	AI 16	30031-30032
Power_W_3	AI 17	30033-30034
Power_W_4	AI 18	30035-30036
Power_W_5	AI 19	30037-30038
Vol_Flo_L_H_1	AI 20	30039-30040
Vol_Flo_L_H_2	AI 21	30041-30042
Vol_Flo_L_H_3	AI 22	30043-30044
Vol_Flo_L_H_4	AI 23	30045-30046
Vol_Flo_ML_S_1	AI 24	30047-30048
Volume_1	AI 25	30049-30050
Volume_2	AI 26	30051-30052
Volume_3	AI 27	30053-30054
Volume_4	AI 28	30055-30056
Volume_5	AI 29	30057-30058
Volume_6	AI 30	30059-30060
Volume_7	AI 31	30061-30062

Appendix B.13. Amtron Sonic D Mappings to BACnet and Modbus

Point Name	BACnet	Modbus
Energy_T_WH_1	AI 01	30001-30002
Energy_T_WH_2	AI 02	30003-30004
Energy_T_WH_3	AI 03	30005-30006
Temp_Flow_1	AI 04	30007-30008
Temp_Ret_1	AI 05	30009-30010
Temp_Dif_1	AI 06	30011-30012
Time_Op_Days_1	AI 07	30013-30014
Power_W_1	AI 08	30015-30016
Vol_Flo_L_S_1	AI 09	30017-30018
Volume_1	AI 10	30019-30020
Volume_2	AI 11	30021-30022
Time_Point_1	AI 12	30023-30024
Time_Point_2	AI 13	30025-30026
Time_Point_3	AI 14	30027-30028
Time_Point_4	AI 15	30029-30030

Appendix B.14. Shenitech STUF-280T Mappings to BACnet and Modbus

Point Name	BACnet	Modbus
Dur_Avg_S_1	AI 01	30001-30002
Dur_Avg_S_2	AI 02	30003-30004
Dur_Avg_S_3	AI 03	30005-30006
Dur_Act_Sec_1	AI 04	30007-30008
Dur_Act_Sec_2	AI 05	30009-30010
Dur_Act_Sec_3	AI 06	30011-30012
Temp_Flow_1	AI 07	30013-30014
Temp_Flow_2	AI 08	30015-30016
Temp_Flow_3	AI 09	30017-30018
Temp_Ret_1	AI 10	30019-30020

Temp_Ret_2	AI 11	30021-30022
Temp_Ret_3	AI 12	30023-30024
Power_W_1	AI 13	30025-30026
Power_W_2	AI 14	30027-30028
Power_W_3	AI 15	30029-30030
Vol_Flo_L_H_1	AI 16	30031-30032
Vol_Flo_L_H_2	AI 17	30033-30034
Vol_Flo_L_H_3	AI 18	30035-30036
Volume_1	AI 19	30037-30038
Volume_2	AI 20	30039-30040
Volume_3	AI 21	30041-30042
Enregy_MWH_1	AI 22	30043-30044
Enregy_MWH_2	AI 23	30045-30046
Enregy_MWH_3	AI 24	30047-30048

Appendix B.15. SensusHRI-B1-8Profile Mappings to BACnet and Modbus

Point Name	BACnet	Modbus
Volume_1	AI 1	30001-30002
Meter_ID_1	AI 2	30003-30004

Appendix B.16. KromSchroderTRZ2S1 Mappings to BACnet and Modbus

Point Name	BACnet	Modbus
Volume_1	AI 1	30001-30002
Meter_ID_1	AI 2	30003-30004

Appendix B.17. KromSchroderDE10R25-40B Mappings to BACnet and Modbus

Point Name	BACnet	Modbus
Dur_Avg_S_1	AI 001	30001-30002
Dur_Avg_S_2	AI 002	30003-30004
Dur_Avg_S_3	AI 003	30005-30006
Dur_Avg_S_4	AI 004	30007-30008
Dur_Avg_S_5	AI 005	30009-30010
Dur_Avg_S_6	AI 006	30011-30012
Dur_Avg_S_7	AI 007	30013-30014
Dur_Avg_S_8	AI 008	30015-30016
Dur_Avg_S_9	AI 009	30017-30018
Dur_Avg_S_10	AI 010	30019-30020
Dur_Avg_M_1	AI 011	30021-30022
Dur_Avg_M_2	AI 012	30023-30024
Dur_Avg_M_3	AI 013	30025-30026
Dur_Avg_M_4	AI 014	30027-30028
Dur_Avg_M_5	AI 015	30029-30030
Dur_Avg_M_6	AI 016	30031-30032
Dur_Avg_M_7	AI 017	30033-30034
Dur_Avg_M_8	AI 018	30035-30036
Dur_Avg_M_9	AI 019	30037-30038
Dur_Avg_M_10	AI 020	30039-30040
Dur_Avg_H_1	AI 021	30041-30042
Dur_Avg_H_2	AI 022	30043-30044
Dur_Avg_H_3	AI 023	30045-30046
Dur_Avg_H_4	AI 024	30047-30048
Dur_Avg_H_5	AI 025	30049-30050
Dur_Avg_H_6	AI 026	30051-30052
Dur_Avg_H_7	AI 027	30053-30054

Dur_Avg_H_8	AI 028	30055-30056
Dur_Avg_H_9	AI 029	30057-30058
Dur_Avg_H_10	AI 030	30059-30060
Dur_Avg_D_1	AI 031	30061-30062
Dur_Avg_D_2	AI 032	30063-30064
Dur_Avg_D_3	AI 033	30065-30066
Dur_Avg_D_4	AI 034	30067-30068
Dur_Avg_D_5	AI 035	30069-30070
Dur_Avg_D_6	AI 036	30071-30072
Dur_Avg_D_7	AI 037	30073-30074
Dur_Avg_D_8	AI 038	30075-30076
Dur_Avg_D_9	AI 039	30077-30078
Dur_Avg_D_10	AI 040	30079-30080
Dur_Act_Sec_1	AI 041	30081-30082
Dur_Act_Sec_2	AI 042	30083-30084
Dur_Act_Sec_3	AI 043	30085-30086
Dur_Act_Sec_4	AI 044	30087-30088
Dur_Act_Sec_5	AI 045	30089-30090
Dur_Act_Sec_6	AI 046	30091-30092
Dur_Act_Sec_7	AI 047	30093-30094
Dur_Act_Sec_8	AI 048	30095-30096
Dur_Act_Sec_9	AI 049	30097-30098
Dur_Act_Sec_10	AI 050	30099-30100
Dur_Act_Min_1	AI 051	30101-30102
Dur_Act_Min_2	AI 052	30103-30104
Dur_Act_Min_3	AI 053	30105-30106
Dur_Act_Min_4	AI 054	30107-30108
Dur_Act_Min_5	AI 055	30109-30110
Dur_Act_Min_6	AI 056	30111-30112
Dur_Act_Min_7	AI 057	30113-30114
Dur_Act_Min_8	AI 058	30115-30116
Dur_Act_Min_9	AI 059	30117-30118
Dur_Act_Min_10	AI 060	30119-30120
Dur_Act_Hrs_1	AI 061	30121-30122
Dur_Act_Hrs_2	AI 062	30123-30124
Dur_Act_Hrs_3	AI 063	30125-30126
Dur_Act_Hrs_4	AI 064	30127-30128
Dur_Act_Hrs_5	AI 065	30129-30130
Dur_Act_Hrs_6	AI 066	30131-30132
Dur_Act_Hrs_7	AI 067	30133-30134
Dur_Act_Hrs_8	AI 068	30135-30136
Dur_Act_Hrs_9	AI 069	30137-30138
Dur_Act_Hrs_10	AI 070	30139-30140
Dur_Act_Day_1	AI 071	30141-30142
Dur_Act_Day_2	AI 072	30143-30144
Dur_Act_Day_3	AI 073	30145-30146
Dur_Act_Day_4	AI 074	30147-30148
Dur_Act_Day_5	AI 075	30149-30150
Dur_Act_Day_6	AI 076	30151-30152
Dur_Act_Day_7	AI 077	30153-30154
Dur_Act_Day_8	AI 078	30155-30156
Dur_Act_Day_9	AI 079	30157-30158
Dur_Act_Day_10	AI 080	30159-30160
Energy_T_WH_1	AI 081	30161-30162
Energy_T_WH_2	AI 082	30163-30164
Energy_T_WH_3	AI 083	30165-30166
Energy_T_WH_4	AI 084	30167-30168
Energy_T_WH_5	AI 085	30169-30170
Energy_T_WH_6	AI 086	30171-30172
Energy_T_WH_7	AI 087	30173-30174
Energy_T_WH_8	AI 088	30175-30176
Energy_T_WH_9	AI 089	30177-30178
Energy_T_WH_10	AI 090	30179-30180
Energy_T_J_1	AI 091	30181-30182
Energy_T_J_2	AI 092	30183-30184
Energy_T_J_3	AI 093	30185-30186
Energy_T_J_4	AI 094	30187-30188
Energy_T_J_5	AI 095	30189-30190
Energy_T_J_6	AI 096	30191-30192

Energy_T_J_7	AI 097	30193-30194
Energy_T_J_8	AI 098	30195-30196
Energy_T_J_9	AI 099	30197-30198
Energy_T_J_10	AI 100	30199-30200
Voltage_1	AI 101	30201-30202
Voltage_2	AI 102	30203-30204
Voltage_3	AI 103	30205-30206
Voltage_4	AI 104	30207-30208
Voltage_5	AI 105	30209-30210
Voltage_6	AI 106	30211-30212
Voltage_7	AI 107	30213-30214
Voltage_8	AI 108	30215-30216
Voltage_9	AI 109	30217-30218
Voltage_10	AI 110	30219-30220
Current_1	AI 111	30221-30222
Current_2	AI 112	30223-30224
Current_3	AI 113	30225-30226
Current_4	AI 114	30227-30228
Current_5	AI 115	30229-30230
Current_6	AI 116	30231-30232
Current_7	AI 117	30233-30234
Current_8	AI 118	30235-30236
Current_9	AI 119	30237-30238
Current_10	AI 120	30239-30240
Temp_Ext_1	AI 121	30241-30242
Temp_Ext_2	AI 122	30243-30244
Temp_Ext_3	AI 123	30245-30246
Temp_Ext_4	AI 124	30247-30248
Temp_Ext_5	AI 125	30249-30250
Temp_Ext_6	AI 126	30251-30252
Temp_Ext_7	AI 127	30253-30254
Temp_Ext_8	AI 128	30255-30256
Temp_Ext_9	AI 129	30257-30258
Temp_Ext_10	AI 130	30259-30260
Temp_Flow_1	AI 131	30261-30262
Temp_Flow_2	AI 132	30263-30264
Temp_Flow_3	AI 133	30265-30266
Temp_Flow_4	AI 134	30267-30268
Temp_Flow_5	AI 135	30269-30270
Temp_Flow_6	AI 136	30271-30272
Temp_Flow_7	AI 137	30273-30274
Temp_Flow_8	AI 138	30275-30276
Temp_Flow_9	AI 139	30277-30278
Temp_Flow_10	AI 140	30279-30280
Temp_Ret_1	AI 141	30281-30282
Temp_Ret_2	AI 142	30283-30284
Temp_Ret_3	AI 143	30285-30286
Temp_Ret_4	AI 144	30287-30288
Temp_Ret_5	AI 145	30289-30290
Temp_Ret_6	AI 146	30291-30292
Temp_Ret_7	AI 147	30293-30294
Temp_Ret_8	AI 148	30295-30296
Temp_Ret_9	AI 149	30297-30298
Temp_Ret_10	AI 150	30299-30300
Temp_Dif_1	AI 151	30301-30302
Temp_Dif_2	AI 152	30303-30304
Temp_Dif_3	AI 153	30305-30306
Temp_Dif_4	AI 154	30307-30308
Temp_Dif_5	AI 155	30309-30310
Temp_Dif_6	AI 156	30311-30312
Temp_Dif_7	AI 157	30313-30314
Temp_Dif_8	AI 158	30315-30316
Temp_Dif_9	AI 159	30317-30318
Temp_Dif_10	AI 160	30319-30320
Time_Sec_1	AI 161	30321-30322
Time_Sec_2	AI 162	30323-30324
Time_Sec_3	AI 163	30325-30326
Time_Sec_4	AI 164	30327-30328
Time_Sec_5	AI 165	30329-30330

Time_Sec_6	AI 166	30331-30332
Time_Sec_7	AI 167	30333-30334
Time_Sec_8	AI 168	30335-30336
Time_Sec_9	AI 169	30337-30338
Time_Sec_10	AI 170	30339-30340
Time_Min_1	AI 171	30341-30342
Time_Min_2	AI 172	30343-30344
Time_Min_3	AI 173	30345-30346
Time_Min_4	AI 174	30347-30348
Time_Min_5	AI 175	30349-30350
Time_Min_6	AI 176	30351-30352
Time_Min_7	AI 177	30353-30354
Time_Min_8	AI 178	30355-30356
Time_Min_9	AI 179	30357-30358
Time_Min_10	AI 180	30359-30360
Time_Hrs_1	AI 181	30361-30362
Time_Hrs_2	AI 182	30363-30364
Time_Hrs_3	AI 183	30365-30366
Time_Hrs_4	AI 184	30367-30368
Time_Hrs_5	AI 185	30369-30370
Time_Hrs_6	AI 186	30371-30372
Time_Hrs_7	AI 187	30373-30374
Time_Hrs_8	AI 188	30375-30376
Time_Hrs_9	AI 189	30377-30378
Time_Hrs_10	AI 190	30379-30380
Time_Days_1	AI 191	30381-30382
Time_Days_2	AI 192	30383-30384
Time_Days_3	AI 193	30385-30386
Time_Days_4	AI 194	30387-30388
Time_Days_5	AI 195	30389-30390
Time_Days_6	AI 196	30391-30392
Time_Days_7	AI 197	30393-30394
Time_Days_8	AI 198	30395-30396
Time_Days_9	AI 199	30397-30398
Time_Days_10	AI 200	30399-30400
Time_Op_Sec_1	AI 201	30401-30402
Time_Op_Sec_2	AI 202	30403-30404
Time_Op_Sec_3	AI 203	30405-30406
Time_Op_Sec_4	AI 204	30407-30408
Time_Op_Sec_5	AI 205	30409-30410
Time_Op_Sec_6	AI 206	30411-30412
Time_Op_Sec_7	AI 207	30413-30414
Time_Op_Sec_8	AI 208	30415-30416
Time_Op_Sec_9	AI 209	30417-30418
Time_Op_Sec_10	AI 210	30419-30420
Time_Op_Min_1	AI 211	30421-30422
Time_Op_Min_2	AI 212	30423-30424
Time_Op_Min_3	AI 213	30425-30426
Time_Op_Min_4	AI 214	30427-30428
Time_Op_Min_5	AI 215	30429-30430
Time_Op_Min_6	AI 216	30431-30432
Time_Op_Min_7	AI 217	30433-30434
Time_Op_Min_8	AI 218	30435-30436
Time_Op_Min_9	AI 219	30437-30438
Time_Op_Min_10	AI 220	30439-30440
Time_Op_Hrs_1	AI 221	30441-30442
Time_Op_Hrs_2	AI 222	30443-30444
Time_Op_Hrs_3	AI 223	30445-30446
Time_Op_Hrs_4	AI 224	30447-30448
Time_Op_Hrs_5	AI 225	30449-30450
Time_Op_Hrs_6	AI 226	30451-30452
Time_Op_Hrs_7	AI 227	30453-30454
Time_Op_Hrs_8	AI 228	30455-30456
Time_Op_Hrs_9	AI 229	30457-30458
Time_Op_Hrs_10	AI 230	30459-30460
Time_Op_Days_1	AI 231	30461-30462
Time_Op_Days_2	AI 232	30463-30464
Time_Op_Days_3	AI 233	30465-30466
Time_Op_Days_4	AI 234	30467-30468

Time_Op_Days_5	AI 235	30469-30470
Time_Op_Days_6	AI 236	30471-30472
Time_Op_Days_7	AI 237	30473-30474
Time_Op_Days_8	AI 238	30475-30476
Time_Op_Days_9	AI 239	30477-30478
Time_Op_Days_10	AI 240	30479-30480
Custom_1	AI 241	30481-30482
Custom_2	AI 242	30483-30484
Custom_3	AI 243	30485-30486
Custom_4	AI 244	30487-30488
Custom_5	AI 245	30489-30490
Custom_6	AI 246	30491-30492
Custom_7	AI 247	30493-30494
Custom_8	AI 248	30495-30496
Custom_9	AI 249	30497-30498
Custom_10	AI 250	30499-30500
Power_W_1	AI 251	30501-30502
Power_W_2	AI 252	30503-30504
Power_W_3	AI 253	30505-30506
Power_W_4	AI 254	30507-30508
Power_W_5	AI 255	30509-30510
Power_W_6	AI 256	30511-30512
Power_W_7	AI 257	30513-30514
Power_W_8	AI 258	30515-30516
Power_W_9	AI 259	30517-30518
Power_W_10	AI 260	30519-30520
Power_Jh_1	AI 261	30521-30522
Power_Jh_2	AI 262	30523-30524
Power_Jh_3	AI 263	30525-30526
Power_Jh_4	AI 264	30527-30528
Power_Jh_5	AI 265	30529-30530
Power_Jh_6	AI 266	30531-30532
Power_Jh_7	AI 267	30533-30534
Power_Jh_8	AI 268	30535-30536
Power_Jh_9	AI 269	30537-30538
Power_Jh_10	AI 270	30539-30540
Pressure_1	AI 271	30541-30542
Pressure_2	AI 272	30543-30544
Pressure_3	AI 273	30545-30546
Pressure_4	AI 274	30547-30548
Pressure_5	AI 275	30549-30550
Pressure_6	AI 276	30551-30552
Pressure_7	AI 277	30553-30554
Pressure_8	AI 278	30555-30556
Pressure_9	AI 279	30557-30558
Pressure_10	AI 280	30559-30560
Mass_1	AI 281	30561-30562
Mass_2	AI 282	30563-30564
Mass_3	AI 283	30565-30566
Mass_4	AI 284	30567-30568
Mass_5	AI 285	30569-30570
Mass_6	AI 286	30571-30572
Mass_7	AI 287	30573-30574
Mass_8	AI 288	30575-30576
Mass_9	AI 289	30577-30578
Mass_10	AI 290	30579-30580
Mass_Flow_1	AI 291	30581-30582
Mass_Flow_2	AI 292	30583-30584
Mass_Flow_3	AI 293	30585-30586
Mass_Flow_4	AI 294	30587-30588
Mass_Flow_5	AI 295	30589-30590
Mass_Flow_6	AI 296	30591-30592
Mass_Flow_7	AI 297	30593-30594
Mass_Flow_8	AI 298	30595-30596
Mass_Flow_9	AI 299	30597-30598
Mass_Flow_10	AI 300	30599-30600
Vol_Flo_L_M_1	AI 301	30601-30602
Vol_Flo_L_M_2	AI 302	30603-30604
Vol_Flo_L_M_3	AI 303	30605-30606

Vol_Flo_L_M_4	AI 304	30607-30608
Vol_Flo_L_M_5	AI 305	30609-30610
Vol_Flo_L_M_6	AI 306	30611-30612
Vol_Flo_L_M_7	AI 307	30613-30614
Vol_Flo_L_M_8	AI 308	30615-30616
Vol_Flo_L_M_9	AI 309	30617-30618
Vol_Flo_L_M_10	AI 310	30619-30620
Vol_Flo_L_H_1	AI 311	30621-30622
Vol_Flo_L_H_2	AI 312	30623-30624
Vol_Flo_L_H_3	AI 313	30625-30626
Vol_Flo_L_H_4	AI 314	30627-30628
Vol_Flo_L_H_5	AI 315	30629-30630
Vol_Flo_L_H_6	AI 316	30631-30632
Vol_Flo_L_H_7	AI 317	30633-30634
Vol_Flo_L_H_8	AI 318	30635-30636
Vol_Flo_L_H_9	AI 319	30637-30638
Vol_Flo_L_H_10	AI 320	30639-30640
Vol_Flo_ML_S_1	AI 321	30641-30642
Vol_Flo_ML_S_2	AI 322	30643-30644
Vol_Flo_ML_S_3	AI 323	30645-30646
Vol_Flo_ML_S_4	AI 324	30647-30648
Vol_Flo_ML_S_5	AI 325	30649-30650
Vol_Flo_ML_S_6	AI 326	30651-30652
Vol_Flo_ML_S_7	AI 327	30653-30654
Vol_Flo_ML_S_8	AI 328	30655-30656
Vol_Flo_ML_S_9	AI 329	30657-30658
Vol_Flo_ML_S_10	AI 330	30659-30660
ID_1	AI 331	30661-30662
ID_2	AI 332	30663-30664
ID_3	AI 333	30665-30666
ID_4	AI 334	30667-30668
ID_5	AI 335	30669-30670
ID_6	AI 336	30671-30672
ID_7	AI 337	30673-30674
ID_8	AI 338	30675-30676
ID_9	AI 339	30677-30678
ID_10	AI 340	30679-30680
Volume_1	AI 341	30681-30682
Volume_2	AI 342	30683-30684
Volume_3	AI 343	30685-30686
Volume_4	AI 344	30687-30688
Volume_5	AI 345	30689-30690
Volume_6	AI 346	30691-30692
Volume_7	AI 347	30693-30694
Volume_8	AI 348	30695-30696
Volume_9	AI 349	30697-30698
Volume_10	AI 350	30699-30700
Error_Flags_1	AI 351	30701-30702
Error_Flags_2	AI 352	30703-30704
Error_Flags_3	AI 353	30705-30706
Error_Flags_4	AI 354	30707-30708
Error_Flags_5	AI 355	30709-30710
Error_Flags_6	AI 356	30711-30712
Error_Flags_7	AI 357	30713-30714
Error_Flags_8	AI 358	30715-30716
Error_Flags_9	AI 359	30717-30718
Error_Flags_10	AI 360	30719-30720
Medium_1	AI 361	30721-30722
Medium_2	AI 362	30723-30724
Medium_3	AI 363	30725-30726
Medium_4	AI 364	30727-30728
Medium_5	AI 365	30729-30730
Medium_6	AI 366	30731-30732
Medium_7	AI 367	30733-30734
Medium_8	AI 368	30735-30736
Medium_9	AI 369	30737-30738
Medium_10	AI 370	30739-30740
Unknown_1	AI 371	30741-30742
Unknown_2	AI 372	30743-30744

Unknown_3	AI 373	30745-30746
Unknown_4	AI 374	30747-30748
Unknown_5	AI 375	30749-30750
Unknown_6	AI 376	30751-30752
Unknown_7	AI 377	30753-30754
Unknown_8	AI 378	30755-30756
Unknown_9	AI 379	30757-30758
Unknown_10	AI 380	30759-30760

Appendix B.18. RelayPadPulsM1 Mappings to BACnet and Modbus

Point Name	BACnet	Modbus
Energy_T_WH_1	AI 1	30001-30002
Vol_Flo_L_M_1	AI 2	30003-30004

Appendix B.19. AILA AUF200 Meter Data Profile Mappings to BACnet and Modbus

Point Name	BACnet	Modbus
Energy_Wh_1	AI 1	30001-30002
Energy_Wh_2	AI 2	30003-30004
Temp_Flow	AI 3	30005-30006
Temp_Return	AI 4	30007-30008
Time_Sec	AI 5	30009-30010
Power_W	AI 6	30011-30012
Volume_Flow_L_H	AI 7	30013-30014
Volume	AI 8	30015-30016

Appendix B.20. Siemens WFN21 Mappings to BACnet and Modbus

Point Name	BACnet	Modbus
Energy_T_WH_1	AI 1	30001/30002
Energy_T_WH_2	AI 2	30003/30004
Energy_T_WH_3	AI 3	30005/30006
Energy_T_WH_4	AI 4	30007/30008
Energy_T_WH_5	AI 5	30009/30010
Energy_T_WH_6	AI 6	30011/30012
Energy_T_WH_7	AI 7	30013/30014
Energy_T_WH_8	AI 8	30015/30016
Time_Op_Min_1	AI 9	30017/30018
ID_1	AI 10	30019/30020
Error_Flags_1	AI 11	30021/30022

Appendix B.21. Siemens UH50 Mappings to BACnet and Modbus

Point Name	BACnet	Modbus
Averaging Duration Minutes	AI 1	30001/30002
Averaging Duration Seconds	AI 2	30003/30004
Actuality Duration	AI 3	30005/30006
Energy 1	AI 4	30007/30008
Energy 2	AI 5	30009/30010
Energy 3	AI 6	30011/30012
Energy 4	AI 7	30013/30014
Energy 5	AI 8	30015/30016

Energy 6	AI 9	30017/30018
Energy 7	AI 10	30019/30020
Energy 8	AI 11	30021/30022
Energy 9	AI 12	30023/30024
Energy 10	AI 13	30025/30026
Energy 11	AI 14	30027/30028
Energy 12	AI 15	30029/30030
Flow Temperature 1	AI 16	30031/30032
Flow Temperature 2	AI 17	30033/30034
Flow Temperature 3	AI 18	30035/30036
Return Temperature 1	AI 19	30037/30038
Return Temperature 2	AI 20	30039/30040
Return Temperature 3	AI 21	30041/30042
Temperature Difference	AI 22	30043/30044
On Time 1	AI 23	30045/30046
On Time 2	AI 24	30047/30048
On Time 3	AI 25	30049/30050
On Time 4	AI 26	30051/30052
Power 1	AI 27	30053/30054
Power 2	AI 28	30055/30056
Power 3	AI 29	30057/30058
Power 4	AI 30	30059/30060
Volume Flow 1	AI 31	30061/30062
Volume Flow 2	AI 32	30063/30064
Volume Flow 3	AI 33	30065/30066
Volume 1	AI 34	30067/30068
Volume 2	AI 35	30069/30070
Volume 3	AI 36	30071/30072
Time Point 1	AI 37	30073/30074
Time Point 2	AI 38	30075/30076
Fabrication Number	AI 39	30077/30078

Appendix B.22. Siemens T230 Mappings to BACnet and Modbus

Point Name	BACnet	Modbus
Averaging Duration Seconds 1	AI 1	30001/30002
Averaging Duration Seconds 2	AI 2	30003/30004
Averaging Duration Seconds 3	AI 3	30005/30006
Averaging Duration Minutes 1	AI 4	30007/30008
Averaging Duration Minutes 2	AI 5	30009/30010
Averaging Duration Minutes 3	AI 6	30011/30012
Actuality Duration 1	AI 7	30013/30014
Actuality Duration 2	AI 8	30015/30016
Actuality Duration 3	AI 9	30017/30018
Energy 1	AI 10	30019/30020
Energy 2	AI 11	30021/30022
Energy 3	AI 12	30023/30024
Energy 4	AI 13	30025/30026
Energy 5	AI 14	30027/30028
Energy 6	AI 15	30029/30030
Energy 7	AI 16	30031/30032
Energy 8	AI 17	30033/30034
Energy 9	AI 18	30035/30036
Energy 10	AI 19	30037/30038
Flow Temperature 1	AI 20	30039/30040
Flow Temperature 2	AI 21	30041/30042
Flow Temperature 3	AI 22	30043/30044
Flow Temperature 4	AI 23	30045/30046
Flow Temperature 5	AI 24	30047/30048
Flow Temperature 6	AI 25	30049/30050
Flow Temperature 7	AI 26	30051/30052
Flow Temperature 8	AI 27	30053/30054
Flow Temperature 9	AI 28	30055/30056
Flow Temperature 10	AI 29	30057/30058
Return Temperature 1	AI 30	30059/30060

Return Temperature 2	AI 31	30061/30062
Return Temperature 3	AI 32	30063/30064
Return Temperature 4	AI 33	30065/30066
Return Temperature 5	AI 34	30067/30068
Return Temperature 6	AI 35	30069/30070
Return Temperature 7	AI 36	30071/30072
Return Temperature 8	AI 37	30073/30074
Return Temperature 9	AI 38	30075/30076
Return Temperature 10	AI 39	30077/30078
Temperature Difference 1	AI 40	30079/30080
Temperature Difference 2	AI 41	30081/30082
Temperature Difference 3	AI 42	30083/30084
On Time 1	AI 43	30085/30086
On Time 2	AI 44	30087/30088
On Time 3	AI 45	30089/30090
On Time 4	AI 46	30091/30092
On Time 5	AI 47	30093/30094
On Time 6	AI 48	30095/30096
On Time 7	AI 49	30097/30098
On Time 8	AI 50	30099/30100
On Time 9	AI 51	30101/30102
Operating Hours 1	AI 52	30103/30104
Operating Hours 2	AI 53	30105/30106
Operating Hours 3	AI 54	30107/30108
Operating Hours 4	AI 55	30109/30110
Operating Hours 5	AI 56	30111/30112
Operating Hours 6	AI 57	30113/30114
Power 1	AI 58	30115/30116
Power 2	AI 59	30117/30118
Power 3	AI 60	30119/30120
Power 4	AI 61	30121/30122
Power 5	AI 62	30123/30124
Power 6	AI 63	30125/30126
Power 7	AI 64	30127/30128
Power 8	AI 65	30129/30130
Power 9	AI 66	30131/30132
Power 10	AI 67	30133/30134
Volume Flow 1	AI 68	30135/30136
Volume Flow 2	AI 69	30137/30138
Volume Flow 3	AI 70	30139/30140
Volume Flow 4	AI 71	30141/30142
Volume Flow 5	AI 72	30143/30144
Volume Flow 6	AI 73	30145/30146
Volume Flow 7	AI 74	30147/30148
Volume Flow 8	AI 75	30149/30150
Volume Flow 9	AI 76	30151/30152
Volume Flow 10	AI 77	30153/30154
Volume 1	AI 78	30155/30156
Volume 2	AI 79	30157/30158
Volume 3	AI 80	30159/30160
Volume 4	AI 81	30161/30162
Volume 5	AI 82	30163/30164
Volume 6	AI 83	30165/30166
Time Point 1	AI 84	30167/30168
Time Point 2	AI 85	30169/30170
Time Point 3	AI 86	30171/30172
Time Point 4	AI 87	30173/30174
Time Point 5	AI 88	30175/30176
Time Point 6	AI 89	30177/30178
Fabrication Number 1	AI 90	30179/30180
Fabrication Number 2	AI 91	30181/30182
Fabrication Number 3	AI 92	30183/30184

Appendix B.23. Kamstrup Multical Mappings to BACnet and Modbus

Point Name	BACnet	Modbus
Energy_T_WH_1	AI 1	30001/30002
Energy_T_WH_2	AI 2	30003/30004
Energy_T_WH_3	AI 3	30005/30006
Energy_T_WH_4	AI 4	30007/30008
Energy_T_WH_5	AI 5	30009/30010
Energy_T_WH_6	AI 6	30011/30012
Energy_T_WH_7	AI 7	30013/30014
Energy_T_WH_8	AI 8	30015/30016
Energy_T_WH_9	AI 9	30017/30018
Energy_T_WH_10	AI 10	30019/30020
Energy_T_WH_11	AI 11	30021/30022
Energy_T_WH_12	AI 12	30023/30024
Energy_T_WH_13	AI 13	30025/30026
Energy_T_WH_14	AI 14	30027/30028
Energy_T_WH_15	AI 15	30029/30030
Energy_T_WH_16	AI 16	30031/30032
Energy_T_WH_17	AI 17	30033/30034
Energy_T_WH_18	AI 18	30035/30036
Energy_T_WH_19	AI 19	30037/30038
Energy_T_WH_20	AI 20	30039/30040
Energy_T_WH_21	AI 21	30041/30042
Energy_T_WH_22	AI 22	30043/30044
Energy_T_WH_23	AI 23	30045/30046
Energy_T_J_1	AI 24	30047/30048
Temp_Flow_1	AI 25	30049/30050
Temp_Ret_1	AI 26	30051/30052
Temp_Dif_1	AI 27	30053/30054
Time_Op_Hrs_1	AI 28	30055/30056
Power_W_1	AI 29	30057/30058
Power_W_2	AI 30	30059/30060
Power_W_3	AI 31	30061/30062
Power_Jh_1	AI 32	30063/30064
Vol_Flo_L_H_1	AI 33	30065/30066
Vol_Flo_L_H_2	AI 34	30067/30068
Vol_Flo_L_H_3	AI 35	30069/30070
Volume_1	AI 36	30071/30072
Volume_2	AI 37	30073/30074
Volume_3	AI 38	30075/30076
Volume_4	AI 39	30077/30078
Volume_5	AI 40	30079/30080
Volume_6	AI 41	30081/30082
Time_Pt_1	AI 42	30083/30084
Time_Pt_2	AI 43	30085/30086
Fab_Number_1	AI 44	30087/30088

Appendix B.24. Siemens UH50 Combined Mappings to BACnet and Modbus

Point Name	BACnet	Modbus
Averaging Duration Seconds	AI 1	30001/30002
Averaging Duration Seconds	AI 2	30003/30004
Averaging Duration Seconds	AI 3	30005/30006
Averaging Duration Minutes	AI 4	30007/30008
Averaging Duration Minutes	AI 5	30009/30010
Averaging Duration Minutes	AI 6	30011/30012
Actuality Duration	AI 7	30013/30014
Actuality Duration	AI 8	30015/30016
Actuality Duration	AI 9	30017/30018
Energy 1	AI 10	30019/30020
Energy 2	AI 11	30021/30022
Energy 3	AI 12	30023/30024

Energy 4	AI 13	30025/30026
Energy 5	AI 14	30027/30028
Energy 6	AI 15	30029/30030
Energy 7	AI 16	30031/30032
Energy 8	AI 17	30033/30034
Energy 9	AI 18	30035/30036
Energy 10	AI 19	30037/30038
Energy 11	AI 20	30039/30040
Energy 12	AI 21	30041/30042
Flow Temperature 1	AI 22	30043/30044
Flow Temperature 2	AI 23	30045/30046
Flow Temperature 3	AI 24	30047/30048
Flow Temperature 4	AI 25	30049/30050
Flow Temperature 5	AI 26	30051/30052
Flow Temperature 6	AI 27	30053/30054
Flow Temperature 7	AI 28	30055/30056
Flow Temperature 8	AI 29	30057/30058
Flow Temperature 9	AI 30	30059/30060
Return Temperature 1	AI 31	30061/30062
Return Temperature 2	AI 32	30063/30064
Return Temperature 3	AI 33	30065/30066
Return Temperature 4	AI 34	30067/30068
Return Temperature 5	AI 35	30069/30070
Return Temperature 6	AI 36	30071/30072
Return Temperature 7	AI 37	30073/30074
Return Temperature 8	AI 38	30075/30076
Return Temperature 9	AI 39	30077/30078
Temperature Difference 1	AI 40	30079/30080
Temperature Difference 2	AI 41	30081/30082
Temperature Difference 3	AI 42	30083/30084
On Time 1	AI 43	30085/30086
On Time 2	AI 44	30087/30088
On Time 3	AI 45	30089/30090
On Time 4	AI 46	30091/30092
On Time 5	AI 47	30093/30094
On Time 6	AI 48	30095/30096
On Time 7	AI 49	30097/30098
On Time 8	AI 50	30099/30100
On Time 9	AI 51	30101/30102
On Time 10	AI 52	30103/30104
Power 1	AI 53	30105/30106
Power 2	AI 54	30107/30108
Power 3	AI 55	30109/30110
Power 4	AI 56	30111/30112
Power 5	AI 57	30113/30114
Power 6	AI 58	30115/30116
Power 7	AI 59	30117/30118
Power 8	AI 60	30119/30120
Power 9	AI 61	30121/30122
Power 10	AI 62	30123/30124
Volume Flow 1	AI 63	30125/30126
Volume Flow 2	AI 64	30127/30128
Volume Flow 3	AI 65	30129/30130
Volume Flow 4	AI 66	30131/30132
Volume Flow 5	AI 67	30133/30134
Volume Flow 6	AI 68	30135/30136
Volume Flow 7	AI 69	30137/30138
Volume Flow 8	AI 70	30139/30140
Volume Flow 9	AI 71	30141/30142
Volume 1	AI 72	30143/30144
Volume 2	AI 73	30145/30146
Volume 3	AI 74	30147/30148
Volume 4	AI 75	30149/30150
Volume 5	AI 76	30151/30152
Volume 6	AI 77	30153/30154
Volume 7	AI 78	30155/30156
Volume 8	AI 79	30157/30158
Volume 9	AI 80	30159/30160
Time Point 1	AI 81	30161/30162

Time Point 2	AI 82	30163/30164
Time Point 3	AI 83	30165/30166
Time Point 4	AI 84	30167/30168
Time Point 5	AI 85	30169/30170
Time Point 6	AI 86	30171/30172
Fabrication Number 1	AI 87	30173/30174
Fabrication Number 2	AI 88	30175/30176
Fabrication Number 3	AI 89	30177/30178

Appendix B.25. Sensostar 2C Mappings to BACnet and Modbus

Point Name	BACnet	Modbus
Energy_T_WH_1	AI 1	30001/30002
Energy_T_J_1	AI 2	30003/30004
Temp_Ext_1	AI 3	30005/30006
Temp_Flow_1	AI 4	30007/30008
Temp_Ret_1	AI 5	30009/30010
Temp_Dif_1	AI 6	30011/30012
Vol_Flo_L_H_1	AI 7	30013/30014
Vol_Flo_ML_S_10	AI 8	30015/30016
ID_1	AI 9	30017/30018
Volume_1	AI 10	30019/30020

Appendix B.26. Axis SKU-03 Mappings to BACnet and Modbus

Point Name	BACnet	Modbus
Energy_T_WH_1	AI 1	30001/30002
Temp_Flow_1	AI 2	30003/30004
Temp_Ret_1	AI 3	30005/30006
Temp_Dif_1	AI 4	30007/30008
Time_Sec_1	AI 5	30009/30010
Time_Op_Sec_1	AI 6	30011/30012
Power_W_1	AI 7	30013/30014
Vol_Flo_L_M_1	AI 8	30015/30016
ID_1	AI 9	30017/30018
Volume_1	AI 10	30019/30020
Error_Flags_1	AI 11	30021/30022
M_Bus_State_1	AI 12	30023/30024

Appendix B.27. ECS Elec Mtr Mappings to BACnet and Modbus

Point Name	BACnet	Modbus
Energy_T_WH_1	AI 1	30001/30002
Energy_T_WH_2	AI 2	30003/30004
Energy_T_WH_3	AI 3	30005/30006
Energy_T_WH_4	AI 4	30007/30008
Energy_T_WH_5	AI 5	30009/30010
Energy_T_WH_6	AI 6	30011/30012
Voltage_1	AI 7	30013/30014
Voltage_2	AI 8	30015/30016
Voltage_3	AI 9	30017/30018
Current_1	AI 10	30019/30020
Current_2	AI 11	30021/30022
Current_3	AI 12	30023/30024
Current_4	AI 13	30025/30026
Power_W_1	AI 14	30027/30028
Power_W_2	AI 15	30029/30030

Power_W_3	AI 16	30031/30032
Power_W_4	AI 17	30033/30034
Power_W_5	AI 18	30035/30036
Power_W_6	AI 19	30037/30038
Power_W_7	AI 20	30039/30040
Power_W_8	AI 21	30041/30042
ID_1	AI 22	30043/30044
Error_Flags_1	AI 23	30045/30046
Unknown_2	AI 24	30047/30048
Unknown_3	AI 25	30049/30050
Unknown_4	AI 26	30051/30052
Unknown_5	AI 27	30053/30054
Unknown_6	AI 28	30055/30056

Time_Min_1	AI 4	30007/30008
Custom_1	AI 5	30009/30010
Power_W_1	AI 6	30011/30012
Pressure_1	AI 7	30013/30014
Mass_1	AI 8	30015/30016
Vol_Flo_L_M_1	AI 9	30017/30018
Volume_1	AI 10	30019/30020
Unknown_1	AI 11	30021/30022
Unknown_2	AI 12	30023/30024
Unknown_3	AI 13	30025/30026
Unknown_4	AI 14	30027/30028
Time_Pt_1	AI 15	30029/30030

Appendix B.28. Diehl Hydrus Mappings to BACnet and Modbus

Point Name	BACnet	Modbus
Temp_Flow_1	AI 1	30001/30002
Vol_Flo_L_H_1	AI 2	30003/30004
Volume_1	AI 3	30005/30006
Volume_2	AI 4	30007/30008
Volume_3	AI 5	30009/30010
Time_Pt_1	AI 6	30011/30012

Appendix B.31. Hydrometer Mappings to BACnet and Modbus

Point Name	BACnet	Modbus
Energy_T_WH_1	AI 1	30001/30002
Energy_T_WH_2	AI 2	30003/30004
Energy_T_WH_3	AI 3	30005/30006
Energy_T_WH_4	AI 4	30007/30008
Energy_T_WH_5	AI 5	30009/30010
Energy_T_WH_6	AI 6	30011/30012
Energy_T_WH_7	AI 7	30013/30014
Energy_T_WH_8	AI 8	30015/30016
Energy_T_WH_9	AI 9	30017/30018
Energy_T_WH_10	AI 10	30019/30020
Temp_Flow_1	AI 11	30021/30022
Temp_Flow_2	AI 12	30023/30024
Temp_Flow_3	AI 13	30025/30026
Temp_Ret_1	AI 14	30027/30028
Temp_Ret_2	AI 15	30029/30030
Temp_Ret_3	AI 16	30031/30032
Temp_Dif_1	AI 17	30033/30034
Temp_Dif_2	AI 18	30035/30036
Temp_Dif_3	AI 19	30037/30038
Time_Op_Hrs_1	AI 20	30039/30040
Time_Op_Hrs_2	AI 21	30041/30042
Time_Op_Hrs_3	AI 22	30043/30044
Power_W_1	AI 23	30045/30046
Power_W_2	AI 24	30047/30048
Power_W_3	AI 25	30049/30050
Vol_Flo_L_H_1	AI 26	30051/30052
Vol_Flo_L_H_2	AI 27	30053/30054
Vol_Flo_L_H_3	AI 28	30055/30056
Volume_1	AI 29	30057/30058
Volume_2	AI 30	30059/30060
Volume_3	AI 31	30061/30062
Volume_4	AI 32	30063/30064
Volume_5	AI 33	30065/30066
Volume_6	AI 34	30067/30068
Volume_7	AI 35	30069/30070
Volume_8	AI 36	30071/30072
Volume_9	AI 37	30073/30074
Volume_10	AI 38	30075/30076
Time_Pt_1	AI 39	30077/30078
Time_Pt_2	AI 40	30079/30080
Time_Pt_3	AI 41	30081/30082
Time_Pt_4	AI 42	30083/30084
Time_Pt_5	AI 43	30085/30086
Time_Pt_6	AI 44	30087/30088
Time_Pt_7	AI 45	30089/30090
Time_Pt_8	AI 46	30091/30092
Time_Pt_9	AI 47	30093/30094
Time_Pt_10	AI 48	30095/30096
Status_Byte	AI 49	30097

Appendix B.29. Diehl Sharky 775 Mappings to BACnet and Modbus

Point Name	BACnet	Modbus
Energy_T_WH_1	AI 1	30001/30002
Energy_T_WH_2	AI 2	30003/30004
Energy_T_WH_3	AI 3	30005/30006
Energy_T_WH_4	AI 4	30007/30008
Energy_T_WH_5	AI 5	30009/30010
Energy_T_WH_6	AI 6	30011/30012
Energy_T_WH_7	AI 7	30013/30014
Energy_T_WH_8	AI 8	30015/30016
Temp_Flow_1	AI 9	30017/30018
Temp_Ret_1	AI 10	30019/30020
Temp_Dif_1	AI 11	30021/30022
Time_Days_1	AI 12	30023/30024
Power_W_1	AI 13	30025/30026
Vol_Flo_L_H_1	AI 14	30027/30028
Volume_1	AI 15	30029/30030
Volume_2	AI 16	30031/30032
Volume_3	AI 17	30033/30034
Volume_4	AI 18	30035/30036
Time_Pt_1	AI 19	30037/30038
Time_Pt_2	AI 20	30039/30040
Time_Pt_3	AI 21	30041/30042
Time_Pt_4	AI 22	30043/30044
Time_Pt_5	AI 23	30045/30046

Appendix B.30. Metz T M4 Mappings to BACnet and Modbus

Point Name	BACnet	Modbus
Energy_T_WH_1	AI 1	30001/30002
Energy_T_WH_2	AI 2	30003/30004
Temp_Ext_1	AI 3	30005/30006

Appendix B.32. Kamstrup 402 Mappings to BACnet and Modbus

Point Name	BACnet	Modbus
Energy_T_WH_1	AI 1	30001/30002
Energy_T_WH_2	AI 2	30003/30004
Energy_T_WH_3	AI 3	30005/30006
Energy_T_WH_4	AI 4	30007/30008
Energy_T_WH_5	AI 5	30009/30010
Energy_T_WH_6	AI 6	30011/30012
Energy_T_WH_7	AI 7	30013/30014
Energy_T_WH_8	AI 8	30015/30016
Energy_T_WH_9	AI 9	30017/30018
Energy_T_WH_10	AI 10	30019/30020
Temp_Flow_1	AI 11	30021/30022
Temp_Flow_2	AI 12	30023/30024
Temp_Flow_3	AI 13	30025/30026
Temp_Ret_1	AI 14	30027/30028
Temp_Ret_2	AI 15	30029/30030
Temp_Ret_3	AI 16	30031/30032
Temp_Dif_1	AI 17	30033/30034
Temp_Dif_2	AI 18	30035/30036
Temp_Dif_3	AI 19	30037/30038
Time_Op_Hrs_1	AI 20	30039/30040
Time_Op_Hrs_2	AI 21	30041/30042
Time_Op_Hrs_3	AI 22	30043/30044
Power_W_1	AI 23	30045/30046
Power_W_2	AI 24	30047/30048
Power_W_3	AI 25	30049/30050
Vol_Flo_L_H_1	AI 26	30051/30052
Vol_Flo_L_H_2	AI 27	30053/30054
Vol_Flo_L_H_3	AI 28	30055/30056
Volume_1	AI 29	30057/30058
Volume_2	AI 30	30059/30060
Volume_3	AI 31	30061/30062
Volume_4	AI 32	30063/30064
Volume_5	AI 33	30065/30066
Volume_6	AI 34	30067/30068
Volume_7	AI 35	30069/30070
Volume_8	AI 36	30071/30072
Volume_9	AI 37	30073/30074
Volume_10	AI 38	30075/30076
Time_Pt_1	AI 39	30077/30078
Time_Pt_2	AI 40	30079/30080
Time_Pt_3	AI 41	30081/30082
Time_Pt_4	AI 42	30083/30084
Time_Pt_5	AI 43	30085/30086
Time_Pt_6	AI 44	30087/30088
Time_Pt_7	AI 45	30089/30090
Time_Pt_8	AI 46	30091/30092
Time_Pt_9	AI 47	30093/30094
Time_Pt_10	AI 48	30095/30096
Status_Byte	AI 49	30097

APPENDIX C TROUBLESHOOTING TIPS**Appendix C.1. Communicating with the QuickServer Over the Network**

- Confirm that the network cabling is correct.
- Confirm that the computer network card is operational and correctly configured.
- Confirm that there is an Ethernet adapter installed in the PC's Device Manager List, and that it is configured to run the TCP/IP protocol.
- Check that the IP netmask of the PC matches the QuickServer. The Default IP Address of the QuickServer is 192.168.2.X, Subnet Mask is 255.255.255.0.
 - Go to Start|Run
 - Type in "ipconfig"
 - The account settings should be displayed.
 - Ensure that the IP Address is 102.168.2.X and the netmask 255.255.255.0
- Ensure that the PC and QuickServer are on the same IP Network, or assign a Static IP Address to the PC on the 192.168.2.0 network.

Appendix C.2. Take a FieldServer Diagnostic Capture

When there is a problem on-site that cannot easily be resolved, perform a Diagnostic Capture before contacting support. Once the Diagnostic Capture is complete, email it to technical support. The Diagnostic Capture will accelerate diagnosis of the problem.

If the FieldServer bios is updated/released on November 2017 or later then the Diagnostic Capture is performed via the gateway's on-board system.

- Access the FieldServer Diagnostics page via one of the following methods:
 - Open the FieldServer FS-GUI page and click on Diagnostics in the Navigation panel
 - Open the FieldServer Toolbox software and click the diagnose icon  of the desired device

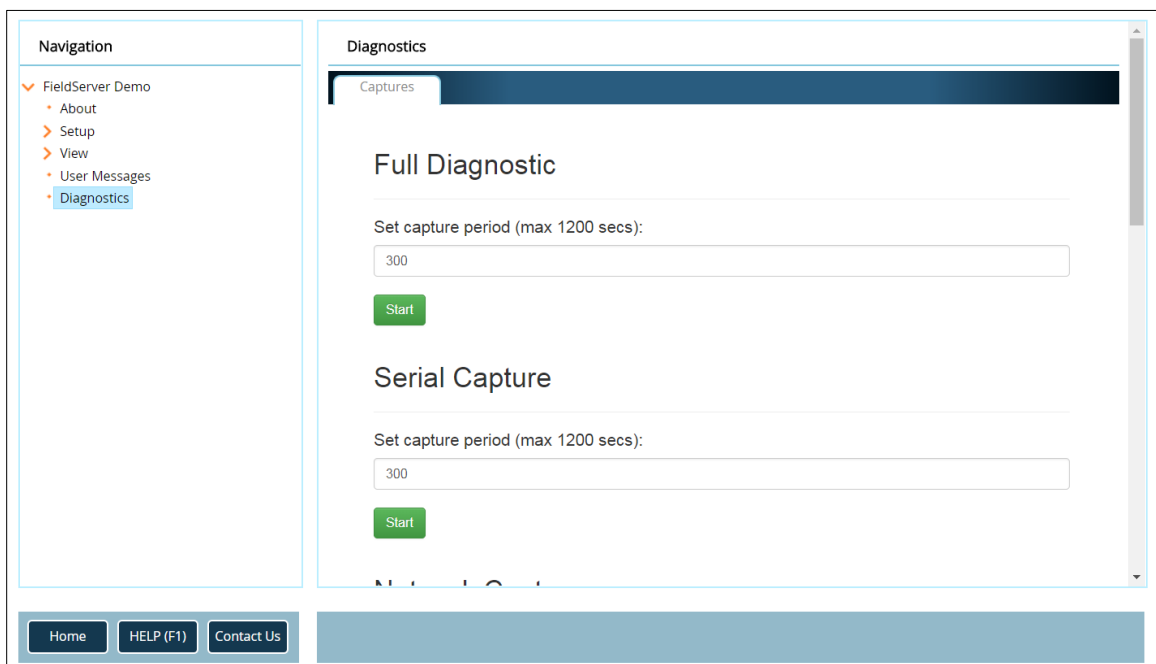

- Go to Full Diagnostic and select the capture period.
- Click the Start button under the Full Diagnostic heading to start the capture.
 - When the capture period is finished, a Download button will appear next to the Start button

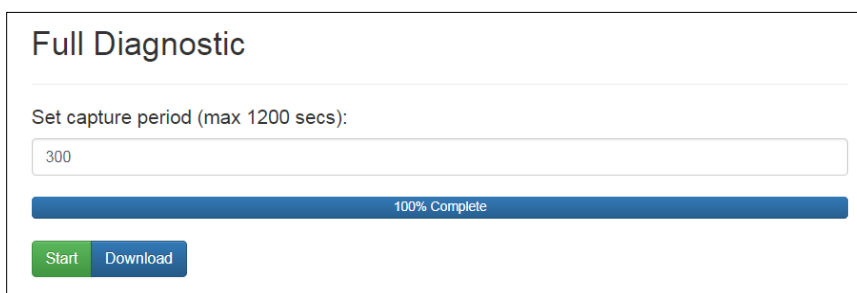

- Click Download for the capture to be downloaded to the local PC.
- Send the diagnostic zip file to technical support.

NOTE: Diagnostic captures of BACnet MS/TP communication are output in a “.PCAP” file extension which is compatible with Wireshark.

Appendix C.2.1. Taking a Capture with Older Firmware

If the FieldServer firmware is from before November 2017, the Diagnostic Capture can be done by downloading the FieldServer Toolbox software but network connections (such as Ethernet and Wi-Fi) cannot be captured (if a network diagnostic is needed take a Wire Shark capture).

Once the Diagnostic Capture is complete, email it to technical support. The Diagnostic Capture will accelerate diagnosis of the problem.

NOTE: While all necessary documentation is shipped with the FieldServer on the USB flash drive, these documents are constantly being updated. Newer versions may be available on the [Sierra Monitor website](#).

- Ensure that FieldServer Toolbox is loaded onto the local PC. Otherwise, download the FieldServer-Toolbox.zip via the Sierra Monitor website's [Software Downloads](#).
- Extract the executable file and complete the installation.

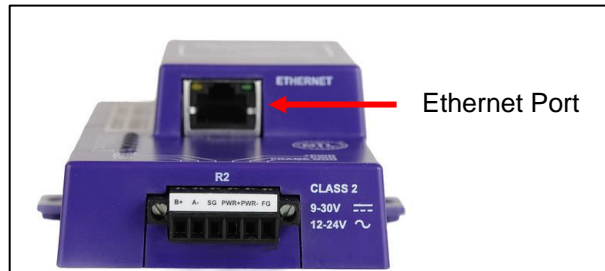

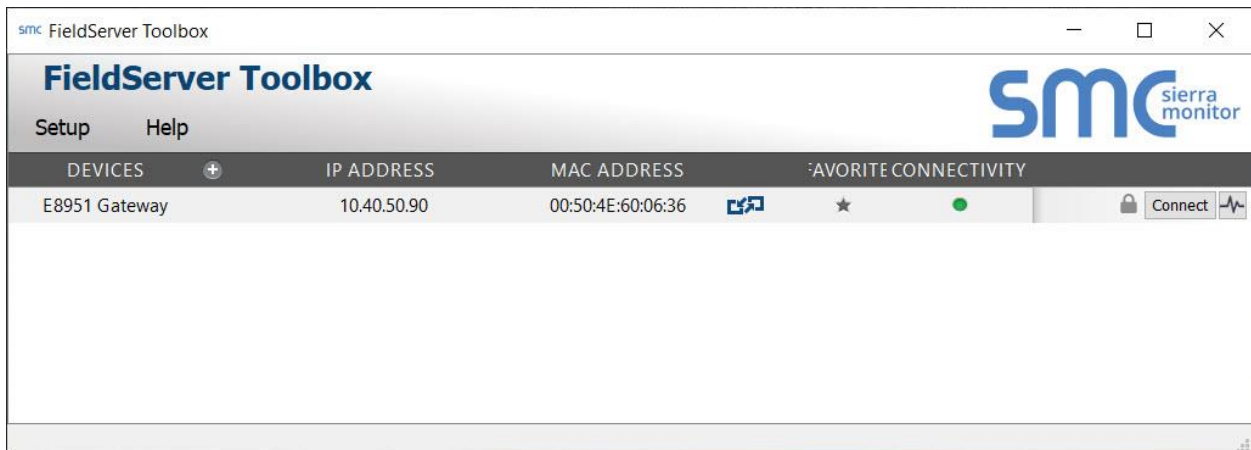

Figure 33: Ethernet Port Location

- Connect a standard Cat-5 Ethernet cable between the PC and QuickServer.
- Double click on the FS Toolbox Utility.
- **Step 1:** Take a Log
 - Click on the diagnose icon  of the desired device



- Select "Full Diagnostic" from the drop down menu



NOTE: If desired, the default capture period can be changed.

- Click on the Start Diagnostic button



- Wait for the capture period to finish and the Diagnostic Test Complete window will appear

• **Step 2: Send Log**

- Once the diagnostic test is complete, a .zip file is saved on the PC

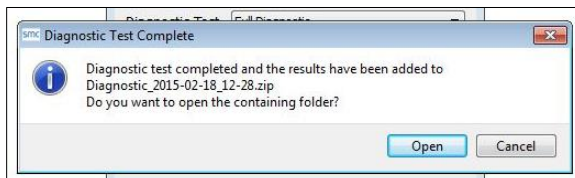

- Click "Open" to launch explorer and have it point directly at the correct folder
- Email the diagnostic zip file to smc-support@msasafety.com



Appendix C.3. Internet Browser Software Support

The following web browsers are supported:

- Chrome Rev. 57 and higher
- Firefox Rev. 35 and higher
- Microsoft Edge Rev. 41 and higher
- Safari Rev. 3 and higher

NOTE: Internet Explorer is no longer supported as recommended by Microsoft.

NOTE: Computer and network firewalls must be opened for Port 80 to allow FieldServer GUI to function.

Appendix C.4. Change Web Server Security Settings After Initial Setup

NOTE: Any changes will require a FieldServer reboot to take effect.

- From the FS-GUI landing page, click Setup in the Navigation panel.

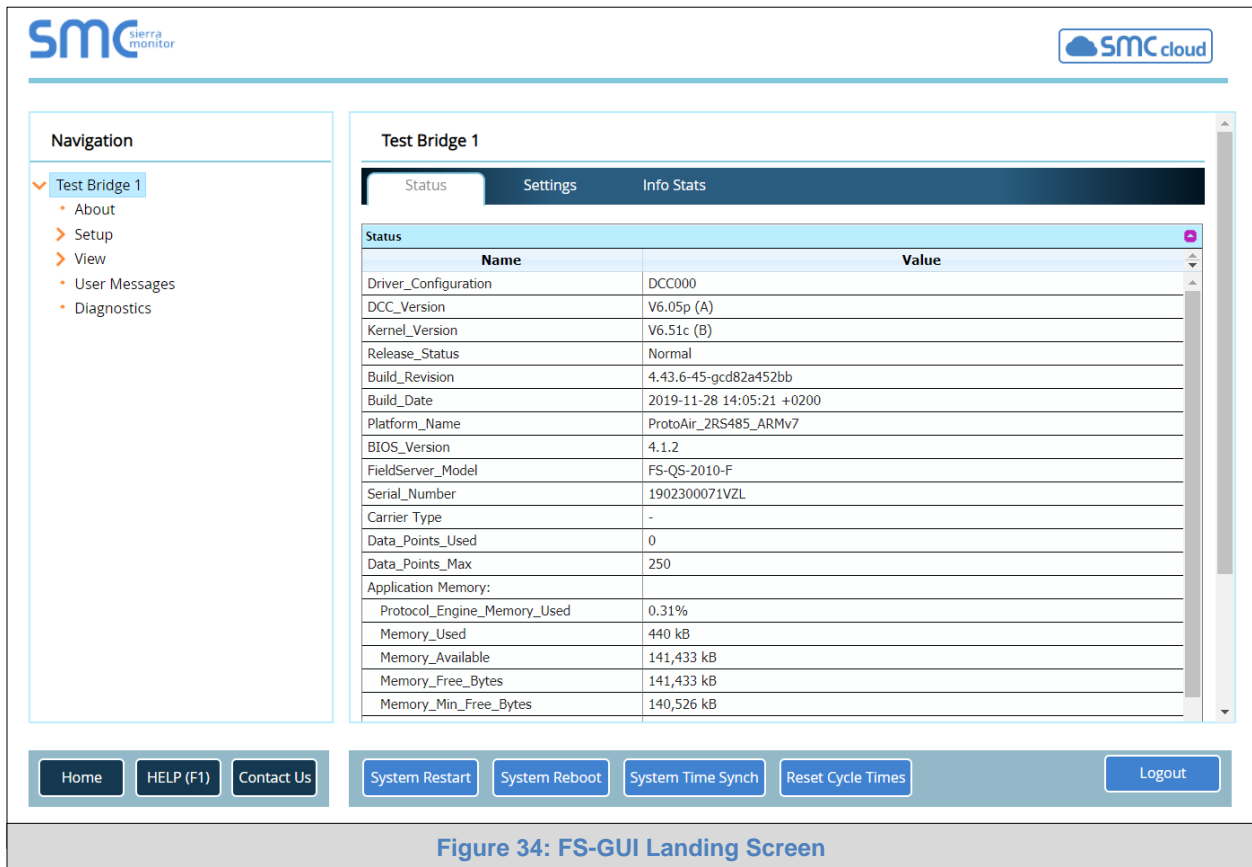

Figure 34: FS-GUI Landing Screen

Appendix C.4.1. Change Security Mode

- Click Security in the Navigation panel.

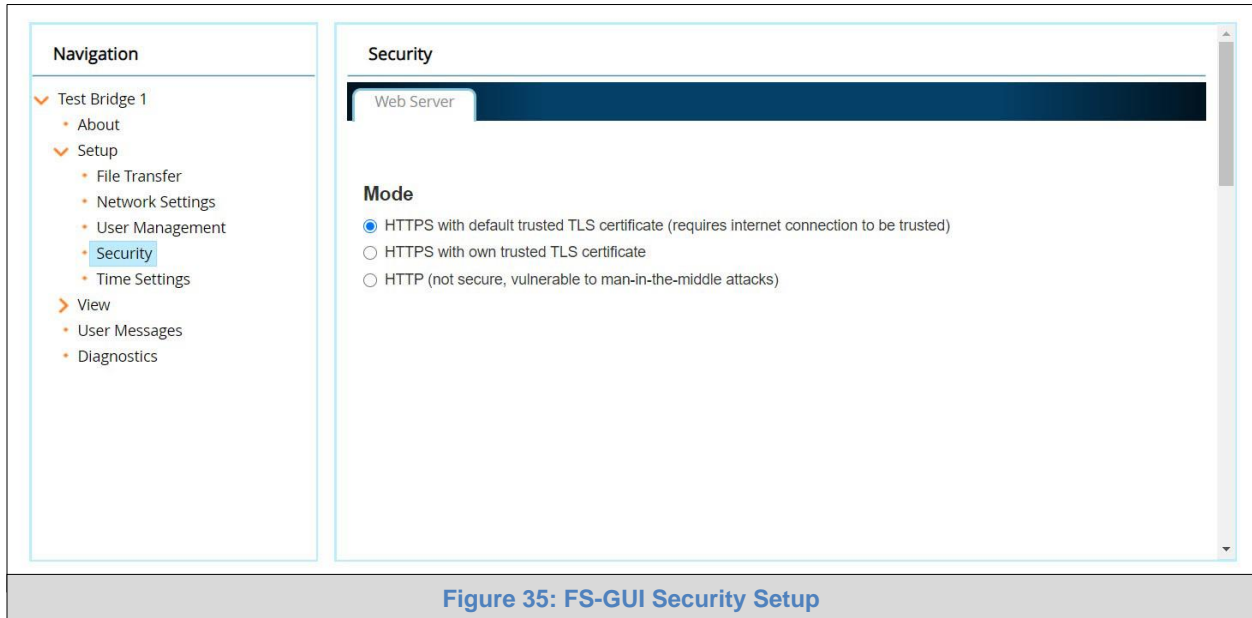

Figure 35: FS-GUI Security Setup

- Click the Mode desired.
 - If HTTPS with own trusted TLS certificate is selected, follow instructions in **Section 7.2.1**
- Click the Save button.

Appendix C.4.2. Edit the Certificate Loaded onto the FieldServer

NOTE: A loaded certificate will only be available if the security mode was previously setup as HTTPS with own trusted TLS certificate.

- Click Security in the Navigation panel.

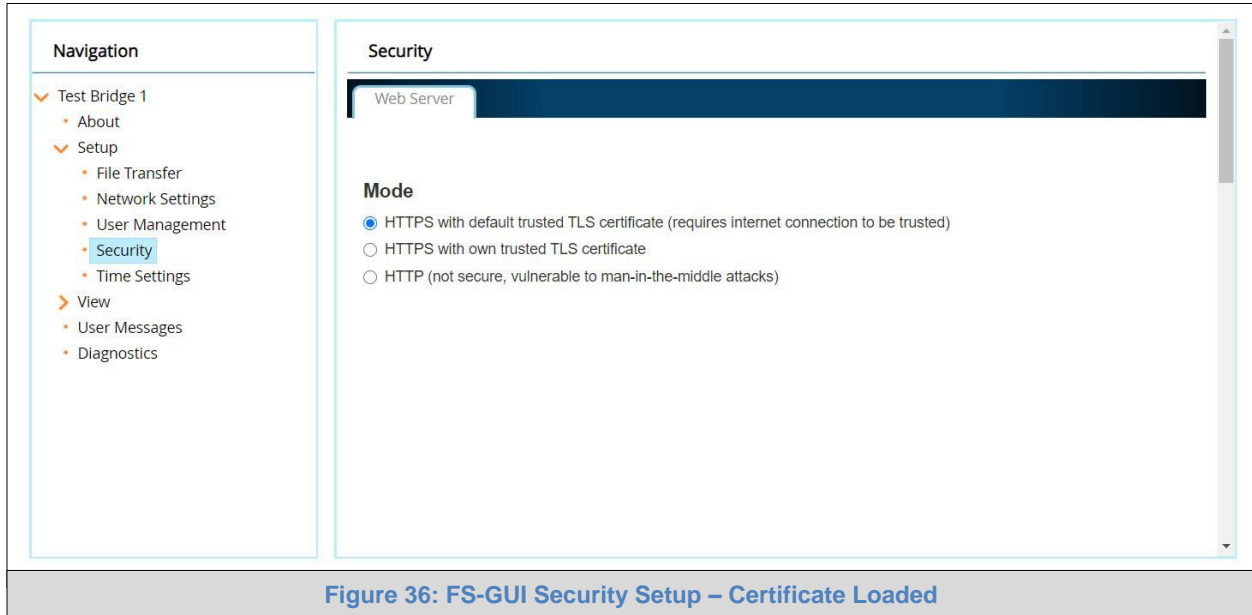

Figure 36: FS-GUI Security Setup – Certificate Loaded

- Click the Edit Certificate button to open the certificate and key fields.
- Edit the loaded certificate or key text as needed.
- Click Save.

Appendix C.5. Change User Management Settings

- From the FS-GUI page, click Setup in the Navigation panel.
- Click User Management in the navigation panel.

NOTE: If the passwords are lost, the unit can be reset to factory settings to reinstate the default unique password on the label. For QuickServer FS-QS-1xxx, ProtoNode, ProtoCessor or ProtoCarrier recovery instructions, see the [FieldServer Recovery Instructions document](#). For QuickServer 2xx0, ProtoNode FPC-N54 or ProtoAir recovery instructions, see the [FieldServer Next Gen Recovery document](#). If the default unique password is lost, then the unit must be mailed back to the factory.

NOTE: Any changes will require a FieldServer reboot to take effect.

Appendix C.5.1. User Management

- Check that the Users tab is selected.

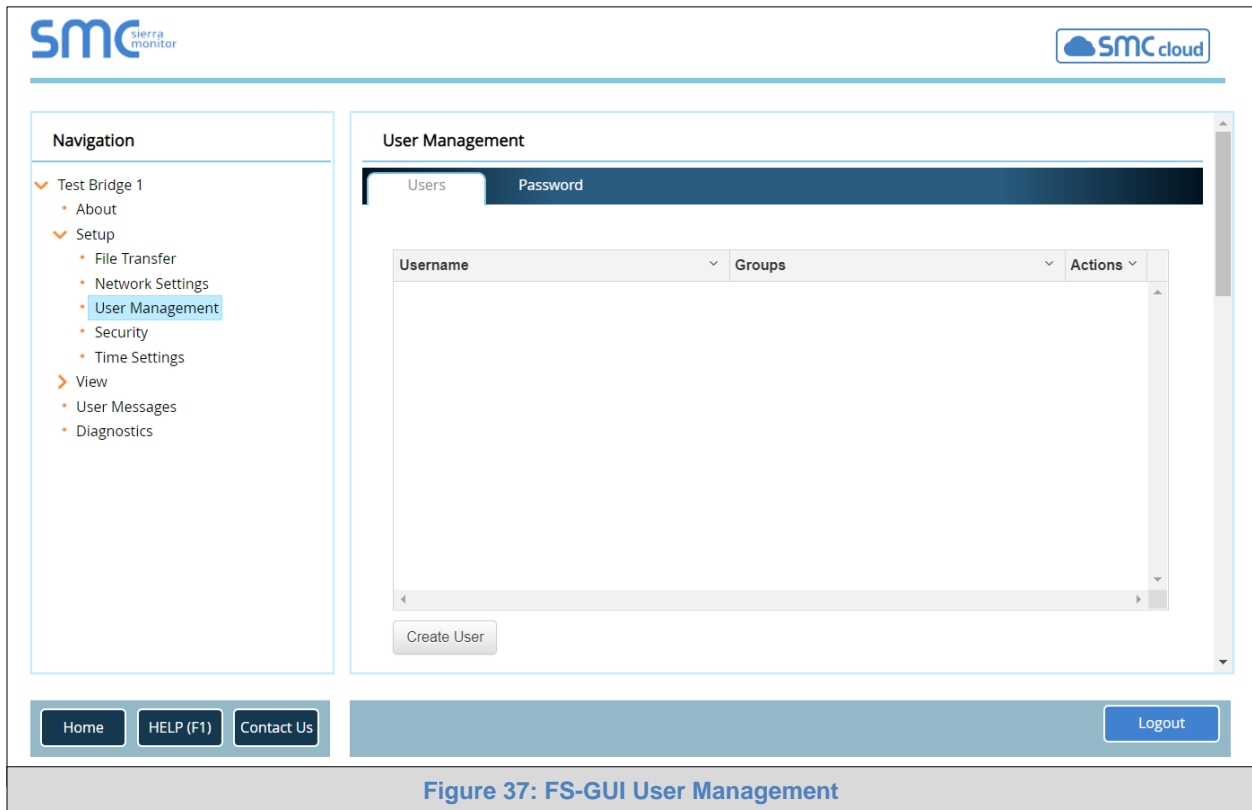

Figure 37: FS-GUI User Management

User Types:

Admin – Can modify any settings on the FieldServer.

Operator – Can modify and view any data in the FieldServer array(s).

Viewer – Can only view settings/readings on the FieldServer.

Appendix C.5.1.1. Create Users

- Click the Create User button.

- Enter the new User fields: Name, Security Group and Password.
 - **User details are hashed and salted**

NOTE: The password must meet the minimum complexity requirements. An algorithm automatically checks the password entered and notes the level of strength on the top right of the Password text field.

- Click the Create button.
- Once the Success message appears, click OK.

Appendix C.5.1.2. Edit Users

- Click the pencil icon next to the desired user to open the User Edit window.

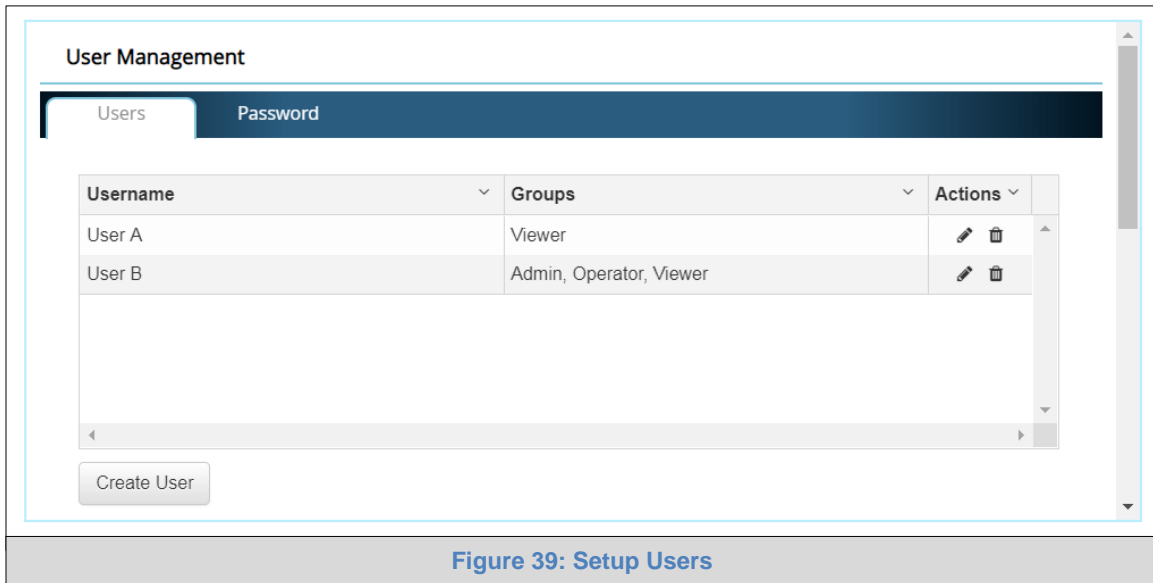

Figure 39: Setup Users

- Once the User Edit window opens, change the User Security Group and Password as needed.

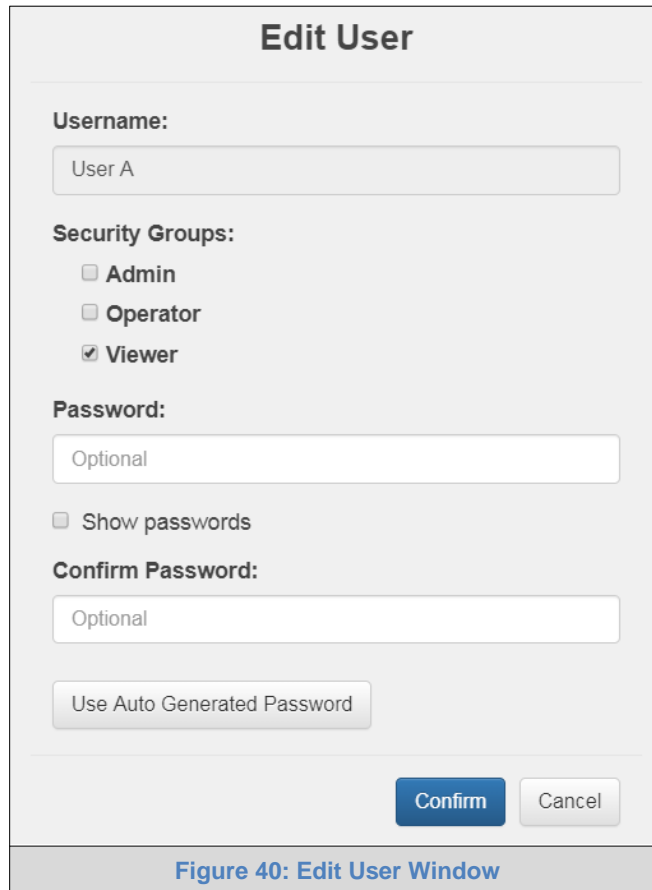

Figure 40: Edit User Window

- Click Confirm.
- Once the Success message appears, click OK.

Appendix C.5.1.3. Delete Users

- Click the trash can icon next to the desired user to delete the entry.

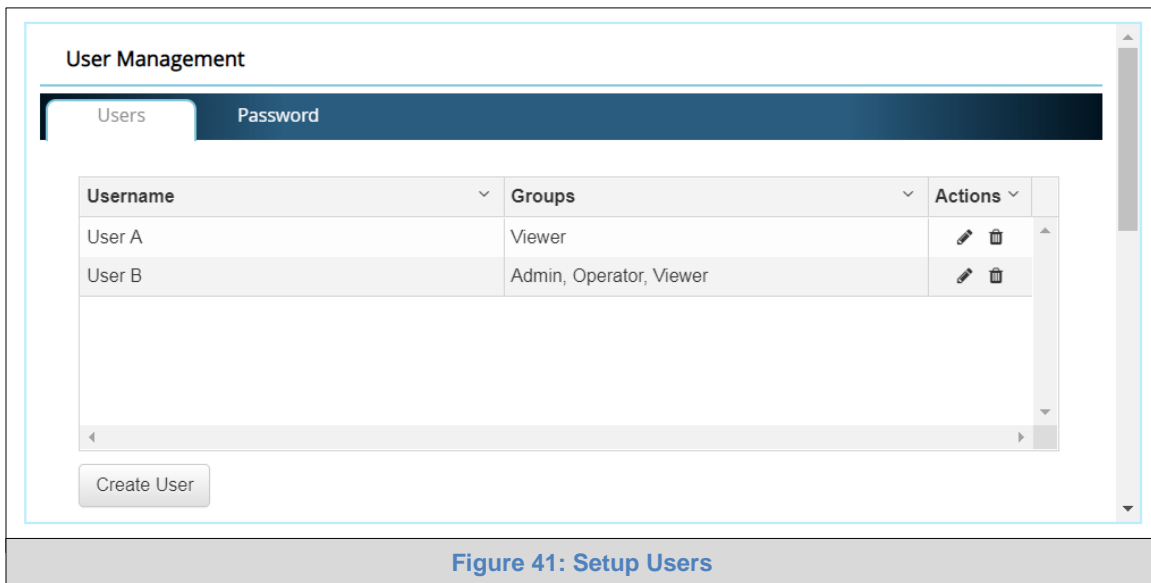

Figure 41: Setup Users

- When the warning message appears, click Confirm.

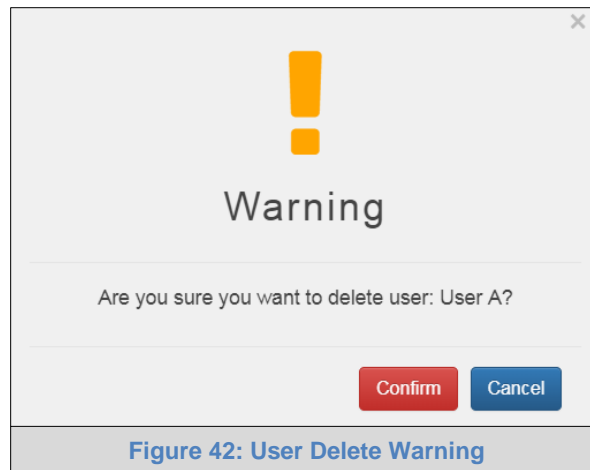

Figure 42: User Delete Warning

Appendix C.5.2. Change FieldServer Password

- Click the Password tab.

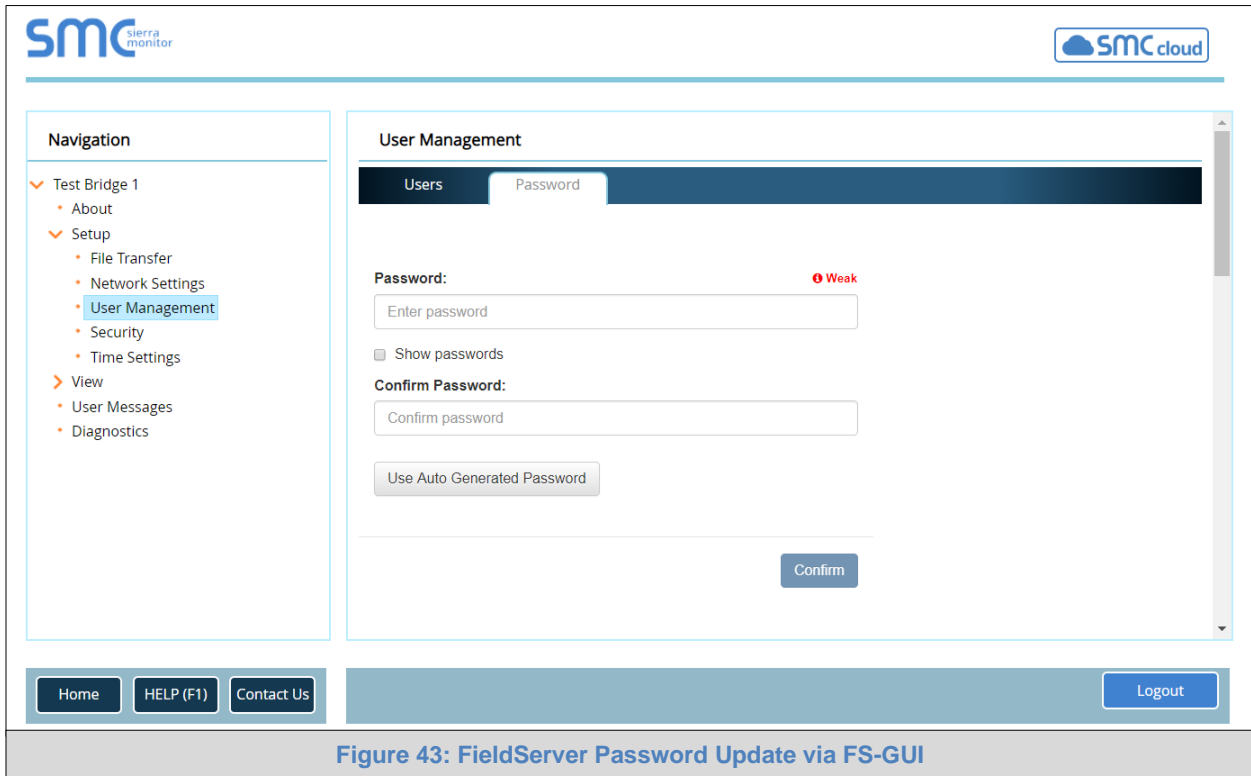

Figure 43: FieldServer Password Update via FS-GUI

- Change the login password for the FieldServer as needed.

NOTE: The password must meet the minimum complexity requirements. An algorithm automatically checks the password entered and notes the level of strength on the top right of the Password text field.

NOTE: If a gateway in the field is updated to a secure gateway, the password will change to “admin”. This change will still occur if the gateway was already setup with a unique password that was loaded in the factory and printed on the label.

APPENDIX D REFERENCE

Appendix D.1. LED Functions

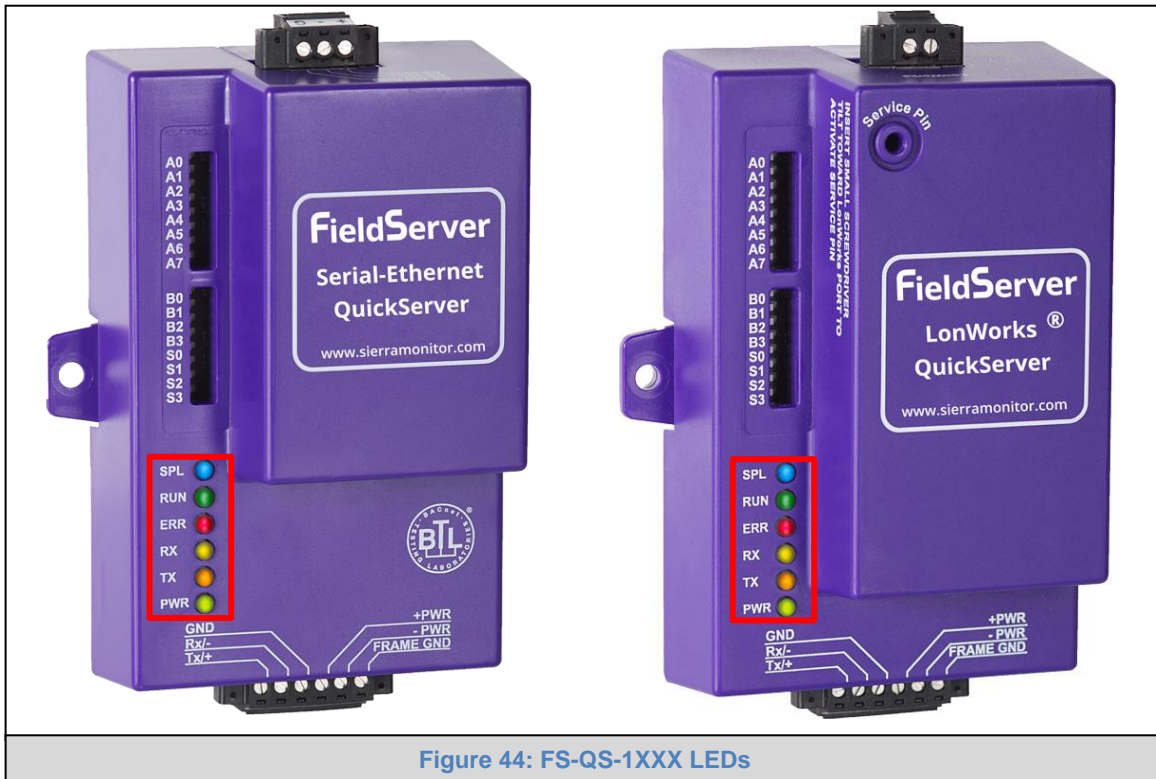

Figure 44: FS-QS-1XXX LEDs

Light	Description
SPL	SPL LED will be on when a configured node in the QuickServer is detected as being offline. See Node overview screen of the FS-GUI for further details. For LonWorks units , LED will light until the unit is commissioned on the LonWorks network.
RUN	RUN LED will flash 20 seconds after power up, signifying normal operation. The QuickServer will be able to access FS-GUI (refer to Section 6.3 for more information) once this LED starts flashing. During the first 20 seconds, the LED should be off.
ERR	The ERR LED will go on solid 15 seconds after power up. It will turn off after 5 seconds. A steady red light will indicate there is a system error on the FieldServer. If this occurs, immediately report the related “system error” shown in the error screen of the FS-GUI interface to the FieldServer for evaluation.
RX	On normal operation of FS-QS-1XXX, the RX LED will flash when a message is received on the field port of the QuickServer.
TX	On normal operation of FS-QS-1XXX, the TX LED will flash when a message is sent on the field port of the QuickServer.
PWR	This is the power light. It should always show a steady green light when powered.

Appendix D.2. QuickServer FS-QS-101X DCC

Driver	Code
BACnet/IP – BACnet MS/TP	0285
BACnet/IP – LonWorks	0131
JCI Metasys N2 ³ – LonWorks	0097
JCI Metasys N2– BACnet MS/TP	0309
JCI Metasys N2– BACnet/IP	0122
Modbus RTU – BACnet MS/TP	0367
Modbus RTU – BACnet/IP	0104
Modbus RTU – JCI Metasys N2	0038
Modbus RTU – LonWorks	0085
Modbus TCP/IP – BACnet/IP	0237
Modbus TCP/IP – LonWorks	0154
Modbus TCP/IP – BACnet MS/TP	0419
Modbus TCP/IP – JCI Metasys N2	0117
SNMP – BACnet/IP	1047
SNMP – LonWorks	1178
SNMP – JCI Metasys N2	1154
SNMP – BACnet MS/TP	1200
BACnet MS/TP - LonWorks	0345

Appendix D.3. QuickServer 1XXX Part Numbers

		Field Connections							
		Interface Connections							
		RS-232 ¹	RS-485 ²	RS-422 ³	KNX ⁶	RS-485	M-Bus	Ethernet ⁴	LonWorks ⁵
QuickServer	FS-QS-1011		1					1	1
	FS-QS-1211		1					1	1
	FS-QS-1221	1						1	1
	FS-QS-1230		1	1				1	
	FS-QS-1231			1				1	1
	FS-QS-1240		1		1			1	
	FS-QS-1241				1			1	1
	FS-QS-1A50					1	1	1	
	FS-QS-1A51						1	1	1
	FS-QS-1B50					1	1	1	
	FS-QS-1B51						1	1	1
	FS-QS-1C50					1	1	1	
	FS-QS-1C51						1	1	1

¹ TX/Rx/GND

² +/-/Frame Ground

³ See Manual

⁴ 10/100 Base T

⁵ FTT10

⁶ KNX/EIB TP1

³ Metasys is a registered trademark of Johnson Controls Inc.

Appendix D.4. Compliance with UL Regulations

For UL compliance, the following instructions must be met when operating QuickServer.

- The units shall be powered by listed LPS or Class 2 power supply suited to the expected operating temperature range.
- The interconnecting power connector and power cable shall:
 - Comply with local electrical code
 - Be suited to the expected operating temperature range
 - Meet the current and voltage rating for QuickServer/Net
- Furthermore, the interconnecting power cable shall:
 - Be of length not exceeding 3.05m (118.3")
 - Be constructed of materials rated VW-1, FT-1 or better
- If the unit is to be installed in an operating environment with a temperature above 65 °C, it should be installed in a Restricted Access Area requiring a key or a special tool to gain access.
- This device must not be connected to a LAN segment with outdoor wiring.

Appendix D.5. Specifications⁴



	FS-QS-12X0-XXXX/ FS-QS-1X50-XXXX ⁵	FS-QS-1011-XXXX/FS-QS-12X1-XXXX/ FS-QS-1X51-XXXX ⁵
Available Ports	6-pin Phoenix connector: RS-485 or RS-232 or RS-422 +/- ground port, power +/- frame ground port 3-pin RS-485 Phoenix connector: RS-485 +/- ground port Ethernet-10/100 port	6-pin Phoenix connector: RS-485 or RS-232 or RS-422 +/- ground port, power +/- frame ground port 2-pin FTT-10 LonWorks port Ethernet-10/100 port
Power Requirements	Input Voltage: 9-30VDC or 12-24VAC Input Power Frequency: 50/60 Hz. Power Rating: 2.5 Watts Current Draw: @ 12V, 150 mA	Input Voltage: 9-30VDC or 12-24VAC Input Power Frequency: 50/60 Hz. Power Rating: 2.5 Watts Current Draw: @ 12V, 279 mA
Approvals	UL 916 approved RoHS3 compliant FCC part 15 compliant DNP compliant CE certified BTL certified WEEE compliant	UL 916 approved, RoHS compliant, FCC part 15 compliant, DNP compliant, LonMark certification, WEEE compliant SPID: 80:00:95:46:00:84:04:01 Profiles: 0000 - Node object (1) 0001 - Open Loop Sensor Object (5) 0003 - Open Loop Actuator Object (5)
Physical Dimensions⁶	5.05 x 2.91 x 1.6 in. (12.82 x 7.39 x 4.06 cm)	
Weight	0.4 lbs (0.2 Kg)	
Operating Temperature	-40°C to 75°C (-40°F to 167°F)	
Surge Suppression	EN61000-4-2 ESD EN61000-4-3 EMC EN61000-4-4 EFT	
Humidity	5 - 90% RH (non-condensing)	
Figure 45: Specifications		

“This device complies with part 15 of the FCC Rules. Operation is subject to the following two conditions:

- This device may not cause harmful interference
- This device must accept any interference received, including interference that may cause undesired operation.

NOTE: This equipment has been tested and found to comply with the limits for a Class A digital device, pursuant to part 15 of the FCC Rules. These limits are designed to provide reasonable protection against harmful interference when the equipment is operated in a commercial environment. This equipment generates, uses, and can radiate radio frequency energy and, if not installed and used in accordance with the instruction manual, may cause harmful interference to radio communications. Operation of this equipment in a residential area is likely to cause harmful interference in which case the user will be required to correct the interference at his expense. Modifications not expressly approved by FieldServer could void the user's authority to operate the equipment under FCC rules.”

⁴ Specifications subject to change without notice.
⁵ XXXX at the end of the part number identifies the code for the specific drivers included in the QuickServer. (Appendix D.2)
⁶ (WxDxH); Excluding mounting tabs.