

# HybridPACK™ Drive Module

FS380R12A6T4B

Final Data Sheet

V3.1, 2019-09-10

Automotive High Power

### 1 Features / Description

HybridPACK™ Drive module with Trench/Fieldstop IGBT4 and Emitter Controlled 4 diode

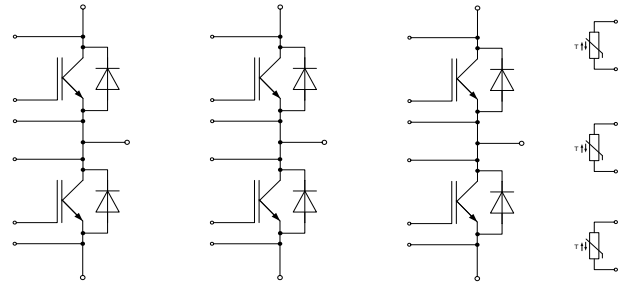
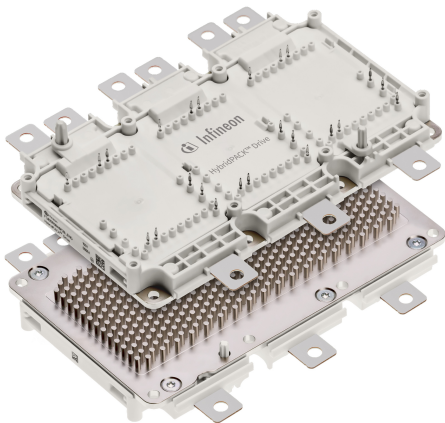

$V_{CES} = 1200\text{ V}$   
 $I_C = 380\text{ A}$

#### Typical Applications

- Automotive Applications
- Hybrid Electrical Vehicles (H)EV
- Motor Drives
- Commercial Agriculture Vehicles

#### Electrical Features

- Blocking voltage 1200V
- Low  $V_{CEsat}$
- Low Switching Losses
- Low  $Q_g$  and  $Cr_{ss}$
- Low Inductive Design
- $T_{vj\ op} = 150^\circ\text{C}$

#### Mechanical Features

- 4.2kV DC 1sec Insulation
- High Creepage and Clearance Distances
- High Power Density
- High Performance Si3N4 Ceramic
- Direct Cooled PinFin Base Plate
- Guiding elements for PCB and cooler assembly
- Integrated NTC temperature sensor
- PressFIT Contact Technology
- RoHS compliant
- UL 94 V0 module frame

#### Description

The HybridPACK™ Drive is a very compact six-pack module (1200V/380A) optimized for hybrid and electric vehicles. The power module implements the IGBT4 generation. The chipset has high short circuit ruggedness and come with a matching efficient and soft switching Emcon4 diode.

The new HybridPACK™ Drive power module family comes with mechanical guiding elements supporting easy assembly processes for customers. Furthermore, the press-fit pins for the signal terminals avoid additional time consuming selective solder processes, which provides cost savings on system level and increases system reliability. The direct cooled baseplate with PinFin structure and optimized ceramic material in the FS380R12A6T4B product best utilizes the implemented chipset and shows superior thermal characteristics. Due to the high clearance & creepage distances, the module well suited for increased system working voltages and supports modular inverter approaches.

Product Name	Ordering Code
FS380R12A6T4B	SP001632438

## 2 IGBT, Inverter

### 2.1 Maximum Rated Values

Parameter	Conditions	Symbol	Value	Unit
Collector-emitter voltage	$T_{vj} = 25^{\circ}\text{C}$	$V_{CES}$	1200 <sup>1)</sup>	V
Implemented collector current		$I_{CN}$	380	A
Continuous DC collector current	$T_F = 100^{\circ}\text{C}$ , $T_{vj\max} = 175^{\circ}\text{C}$	$I_{C\text{nom}}$	250 <sup>2)</sup>	A
Repetitive peak collector current	$t_p = 1\text{ ms}$	$I_{CRM}$	760	A
Total power dissipation	$T_F = 75^{\circ}\text{C}$ , $T_{vj\max} = 175^{\circ}\text{C}$	$P_{\text{tot}}$	870 <sup>2)</sup>	W
Gate-emitter peak voltage		$V_{GES}$	+/-20	V

### 2.2 Characteristic Values

Parameter	Conditions	Symbol	min. typ. max.			Unit	
Collector-emitter saturation voltage	$I_C = 250\text{ A}$ , $V_{GE} = 15\text{ V}$ $I_C = 250\text{ A}$ , $V_{GE} = 15\text{ V}$ $I_C = 250\text{ A}$ , $V_{GE} = 15\text{ V}$ $I_C = 380\text{ A}$ , $V_{GE} = 15\text{ V}$ $I_C = 380\text{ A}$ , $V_{GE} = 15\text{ V}$	$T_{vj} = 25^{\circ}\text{C}$ $T_{vj} = 125^{\circ}\text{C}$ $T_{vj} = 150^{\circ}\text{C}$ $T_{vj} = 25^{\circ}\text{C}$ $T_{vj} = 150^{\circ}\text{C}$	$V_{CE\text{sat}}$	1.60 1.85 1.90 1.95 2.40	1.95	V	
Gate threshold voltage	$I_C = 9.75\text{ mA}$ , $V_{CE} = V_{GE}$	$T_{vj} = 25^{\circ}\text{C}$	$V_{GE\text{th}}$	5.20	5.80	6.40	V
Gate charge	$V_{GE} = -8\text{ V} \dots 15\text{ V}$ , $V_{CE} = 600\text{ V}$		$Q_G$	1.75			$\mu\text{C}$
Internal gate resistor		$T_{vj} = 25^{\circ}\text{C}$	$R_{G\text{int}}$	2.5			$\Omega$
Input capacitance	$f = 1\text{ MHz}$ , $V_{CE} = 25\text{ V}$ , $V_{GE} = 0\text{ V}$	$T_{vj} = 25^{\circ}\text{C}$	$C_{\text{ies}}$	19.0			nF
Reverse transfer capacitance	$f = 1\text{ MHz}$ , $V_{CE} = 25\text{ V}$ , $V_{GE} = 0\text{ V}$	$T_{vj} = 25^{\circ}\text{C}$	$C_{\text{res}}$	0.81			nF
Collector-emitter cut-off current	$V_{CE} = 1200\text{ V}$ , $V_{GE} = 0\text{ V}$	$T_{vj} = 25^{\circ}\text{C}$	$I_{CES}$		1.0		mA
Gate-emitter leakage current	$V_{CE} = 0\text{ V}$ , $V_{GE} = 20\text{ V}$	$T_{vj} = 25^{\circ}\text{C}$	$I_{GES}$		400		nA
Turn-on delay time, inductive load	$I_C = 250\text{ A}$ , $V_{CE} = 600\text{ V}$ $V_{GE} = -8 / +15\text{ V}$ $R_{G\text{on}} = 2.2\ \Omega$	$T_{vj} = 25^{\circ}\text{C}$ $T_{vj} = 125^{\circ}\text{C}$ $T_{vj} = 150^{\circ}\text{C}$	$t_{d\text{on}}$	0.13 0.14 0.14			$\mu\text{s}$
Rise time, inductive load	$I_C = 250\text{ A}$ , $V_{CE} = 600\text{ V}$ $V_{GE} = -8 / +15\text{ V}$ $R_{G\text{on}} = 2.2\ \Omega$	$T_{vj} = 25^{\circ}\text{C}$ $T_{vj} = 125^{\circ}\text{C}$ $T_{vj} = 150^{\circ}\text{C}$	$t_r$	0.05 0.05 0.05			$\mu\text{s}$
Turn-off delay time, inductive load	$I_C = 250\text{ A}$ , $V_{CE} = 600\text{ V}$ $V_{GE} = -8 / +15\text{ V}$ $R_{G\text{off}} = 2.2\ \Omega$	$T_{vj} = 25^{\circ}\text{C}$ $T_{vj} = 125^{\circ}\text{C}$ $T_{vj} = 150^{\circ}\text{C}$	$t_{d\text{off}}$	0.47 0.57 0.60			$\mu\text{s}$
Fall time, inductive load	$I_C = 250\text{ A}$ , $V_{CE} = 600\text{ V}$ $V_{GE} = -8 / +15\text{ V}$ $R_{G\text{off}} = 2.2\ \Omega$	$T_{vj} = 25^{\circ}\text{C}$ $T_{vj} = 125^{\circ}\text{C}$ $T_{vj} = 150^{\circ}\text{C}$	$t_f$	0.10 0.20 0.22			$\mu\text{s}$
Turn-on energy loss per pulse	$I_C = 250\text{ A}$ , $V_{CE} = 600\text{ V}$ , $L_S = 20\text{ nH}$ $V_{GE} = -8 / +15\text{ V}$ $R_{G\text{on}} = 2.2\ \Omega$ $di/dt$ ( $T_{vj} 25^{\circ}\text{C}$ ) = 4000 A/ $\mu\text{s}$ $di/dt$ ( $T_{vj} 150^{\circ}\text{C}$ ) = 3800 A/ $\mu\text{s}$	$T_{vj} = 25^{\circ}\text{C}$ $T_{vj} = 125^{\circ}\text{C}$ $T_{vj} = 150^{\circ}\text{C}$	$E_{\text{on}}$	19.0 26.5 29.0			mJ
Turn-off energy loss per pulse	$I_C = 250\text{ A}$ , $V_{CE} = 600\text{ V}$ , $L_S = 20\text{ nH}$ $V_{GE} = -8 / +15\text{ V}$ $R_{G\text{off}} = 2.2\ \Omega$ $dv/dt$ ( $T_{vj} 25^{\circ}\text{C}$ ) = 3300 V/ $\mu\text{s}$ $dv/dt$ ( $T_{vj} 150^{\circ}\text{C}$ ) = 3000 V/ $\mu\text{s}$	$T_{vj} = 25^{\circ}\text{C}$ $T_{vj} = 125^{\circ}\text{C}$ $T_{vj} = 150^{\circ}\text{C}$	$E_{\text{off}}$	18.5 28.0 31.0			mJ
SC data	$V_{GE} \leq 15\text{ V}$ , $V_{CC} = 800\text{ V}$ $V_{CE\text{max}} = V_{CES} - L_{S\text{CE}} \cdot di/dt$	$t_p \leq 8\ \mu\text{s}$ , $T_{vj} = 25^{\circ}\text{C}$ $t_p \leq 6\ \mu\text{s}$ , $T_{vj} = 150^{\circ}\text{C}$	$I_{SC}$	1500 1200			A
Thermal resistance, junction to cooling fluid	per IGBT; $\Delta V/\Delta t = 10\text{ dm}^3/\text{min}$ , $T_F = 75^{\circ}\text{C}$		$R_{\text{thJF}}$	0.100 <sup>3)</sup>	0.115 <sup>3)</sup>		K/W
Temperature under switching conditions	$t_{\text{op}}$ continuous		$T_{vj\text{op}}$	-40	150		$^{\circ}\text{C}$

<sup>1)</sup> For applications with applied blocking voltage > 60% of the specified maximum collector-emitter voltage, we recommend to evaluate the impact of the cosmic radiation effect in early design phase. For assessment please contact local Infineon sales office.

<sup>2)</sup> Verified by characterization / design not by test.

<sup>3)</sup> Cooler design and flow direction according to application note AN-HPDPERF-ASSEMBLY. Cooling fluid 50% water / 50% ethylenglycol.

### 3 Diode, Inverter

#### 3.1 Maximum Rated Values

Parameter	Conditions	Symbol	Value	Unit
Repetitive peak reverse voltage	$T_{vj} = 25^{\circ}\text{C}$	$V_{RRM}$	1200 <sup>1)</sup>	V
Implemented forward current		$I_{FN}$	380	A
Continuous DC forward current		$I_F$	250 <sup>2)</sup>	A
Repetitive peak forward current	$t_p = 1 \text{ ms}$	$I_{FRM}$	760	A
$I^2t$ - value	$V_R = 0 \text{ V}, t_p = 10 \text{ ms}, T_{vj} = 125^{\circ}\text{C}$	$I^2t$	10000	$\text{A}^2\text{s}$
	$V_R = 0 \text{ V}, t_p = 10 \text{ ms}, T_{vj} = 150^{\circ}\text{C}$		8800	$\text{A}^2\text{s}$

#### 3.2 Characteristic Values

Parameter	Conditions	Symbol	Value			Unit	
			min.	typ.	max.		
Forward voltage	$I_F = 250 \text{ A}, V_{GE} = 0 \text{ V}$	$V_F$		1.60	2.00	V	
	$I_F = 250 \text{ A}, V_{GE} = 0 \text{ V}$			1.55			
	$I_F = 250 \text{ A}, V_{GE} = 0 \text{ V}$			1.55			
	$I_F = 380 \text{ A}, V_{GE} = 0 \text{ V}$			1,85			
Peak reverse recovery current	$I_F = 380 \text{ A}, V_{GE} = 0 \text{ V}$	$I_{RM}$		1,80		A	
	$I_F = 250 \text{ A}, -di_F/dt = 3800 \text{ A}/\mu\text{s} (T_{vj} = 150^{\circ}\text{C})$			$T_{vj} = 25^{\circ}\text{C}$			245
	$V_R = 600 \text{ V}$			$T_{vj} = 125^{\circ}\text{C}$			300
Recovered charge	$V_{GE} = -8 \text{ V}$	$Q_r$		315		$\mu\text{C}$	
	$I_F = 250 \text{ A}, -di_F/dt = 3800 \text{ A}/\mu\text{s} (T_{vj} = 150^{\circ}\text{C})$			$T_{vj} = 25^{\circ}\text{C}$			24.0
	$V_R = 600 \text{ V}$			$T_{vj} = 125^{\circ}\text{C}$			42.5
Reverse recovery energy	$V_{GE} = -8 \text{ V}$	$E_{rec}$		48.0		mJ	
	$I_F = 250 \text{ A}, -di_F/dt = 3800 \text{ A}/\mu\text{s} (T_{vj} = 150^{\circ}\text{C})$			$T_{vj} = 25^{\circ}\text{C}$			10.0
	$V_R = 600 \text{ V}$			$T_{vj} = 125^{\circ}\text{C}$			17.5
Thermal resistance, junction to cooling fluid	per diode; $\Delta V/\Delta t = 10 \text{ dm}^3/\text{min}, T_F = 75^{\circ}\text{C}$	$R_{thJF}$		0.140 <sup>3)</sup>	0.160 <sup>3)</sup>	K/W	
Temperature under switching conditions	$t_{op}$ continuous	$T_{vj op}$	-40		150	$^{\circ}\text{C}$	

### 4 NTC-Thermistor

Parameter	Conditions	Symbol	Value			Unit
			min.	typ.	max.	
Rated resistance	$T_C = 25^{\circ}\text{C}$	$R_{25}$		5.00		k $\Omega$
Deviation of R100	$T_C = 100^{\circ}\text{C}, R_{100} = 493 \Omega$	$\Delta R/R$	5		5	%
Power dissipation	$T_C = 25^{\circ}\text{C}$	$P_{25}$			20.0	mW
B-value	$R_2 = R_{25} \exp [B_{25/50}(1/T_2 - 1/(298,15 \text{ K}))]$	$B_{25/50}$		3375		K
B-value	$R_2 = R_{25} \exp [B_{25/80}(1/T_2 - 1/(298,15 \text{ K}))]$	$B_{25/80}$		3411		K
B-value	$R_2 = R_{25} \exp [B_{25/100}(1/T_2 - 1/(298,15 \text{ K}))]$	$B_{25/100}$		3433		K

Specification according to the valid application note.

<sup>1)</sup> For applications with applied blocking voltage > 60% of the specified maximum collector-emitter voltage, we recommend to evaluate the impact of the cosmic radiation effect in early design phase. For assessment please contact local Infineon sales office.

<sup>2)</sup> Verified by characterization / design not by test.

<sup>3)</sup> Cooler design and flow direction according to application note AN-HPDPERF-ASSEMBLY. Cooling fluid 50% water / 50% ethylenglycol.

## 5 Module

Parameter	Conditions	Symbol	Value			Unit
Isolation test voltage	RMS, f = 0 Hz, t = 1 sec	$V_{ISOL}$	4.2			kV
Maximum RMS module terminal current	$T_F = 75^\circ\text{C}$ , $T_{Ct} = 105^\circ\text{C}$	$I_{IRMS}$	550			A
Material of module baseplate			Cu+Ni <sup>1)</sup>			
Internal isolation	basic insulation (class 1, IEC 61140)		Si <sub>3</sub> N <sub>4</sub>			
Creepage distance	terminal to heatsink terminal to terminal	$d_{Creep}$	9.0			mm
			9.0			
Clearance	terminal to heatsink terminal to terminal	$d_{Clear}$	4.5			mm
			4.5			
Comperative tracking index		CTI	> 200			
			min.	typ.	max.	
Pressure drop in cooling circuit	$\Delta V/\Delta t = 10.0 \text{ dm}^3/\text{min}$ ; $T_F = 75^\circ\text{C}$	$\Delta p$		64 <sup>2)</sup>		mbar
Maximum pressure in cooling circuit	$T_{baseplate} < 40^\circ\text{C}$ $T_{baseplate} > 40^\circ\text{C}$ (relative pressure)	p			2.5 2.0	bar
Stray inductance module		$L_{sCE}$		8.0		nH
Module lead resistance, terminals - chip	$T_F = 25^\circ\text{C}$ , per switch	$R_{CC+EE}$		0.75		mΩ
Storage temperature		$T_{stg}$	-40		125	°C
Mounting torque for modul mounting	Screw M4 baseplate to heatsink	M	1.80	2.00	2.20 <sup>3)</sup>	Nm
Weight		G		720		g

<sup>1)</sup> Ni plated Cu baseplate.

<sup>2)</sup> Cooler design and flow direction according to application note AN-HPDPERF-ASSEMBLY. Cooling fluid 50% water / 50% ethylenglycol.

<sup>3)</sup> According to application note AN-HPDPERF-ASSEMBLY.

## 6 Characteristics Diagrams

output characteristic IGBT, Inverter (typical)

$I_C = f(V_{CE})$   
 $V_{GE} = 15\text{ V}$

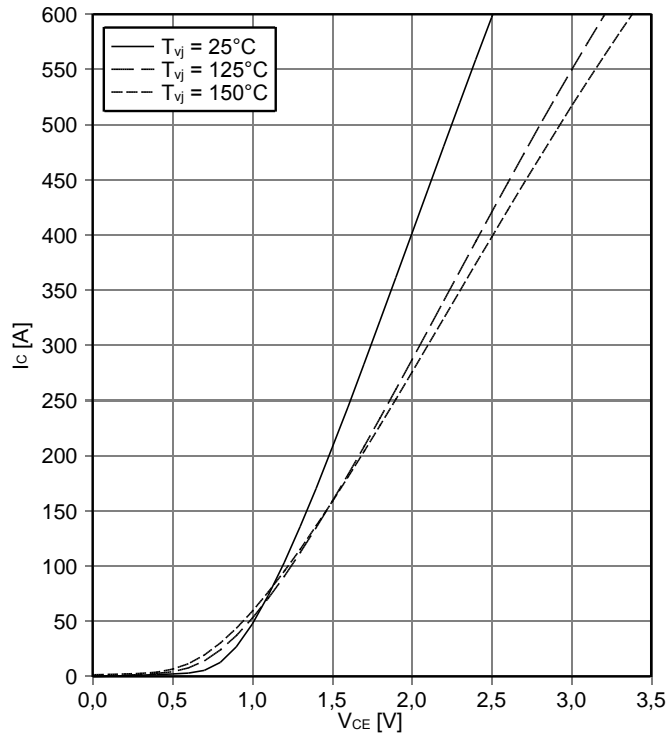

output characteristic IGBT, Inverter (typical)

$I_C = f(V_{CE})$   
 $T_{vj} = 150^\circ\text{C}$

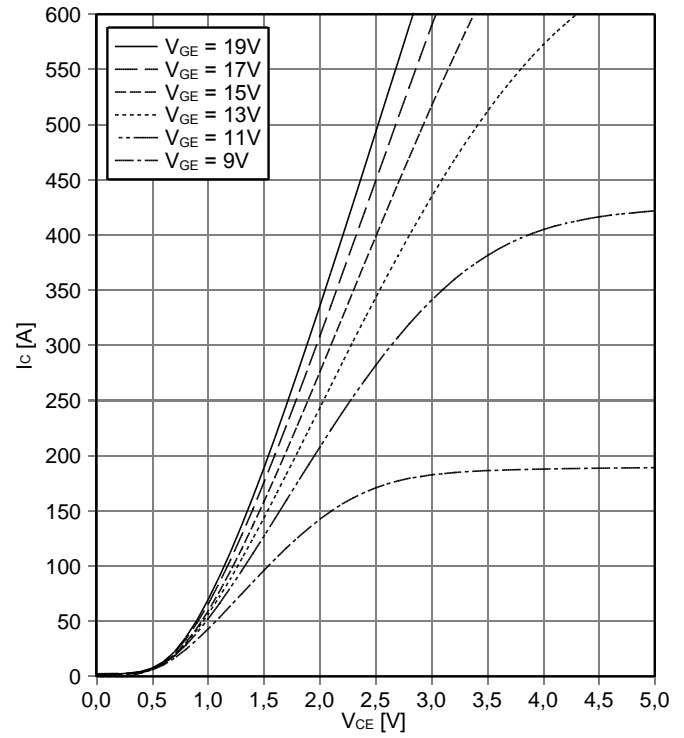

transfer characteristic IGBT, Inverter (typical)

$I_C = f(V_{GE})$   
 $V_{CE} = 20\text{ V}$

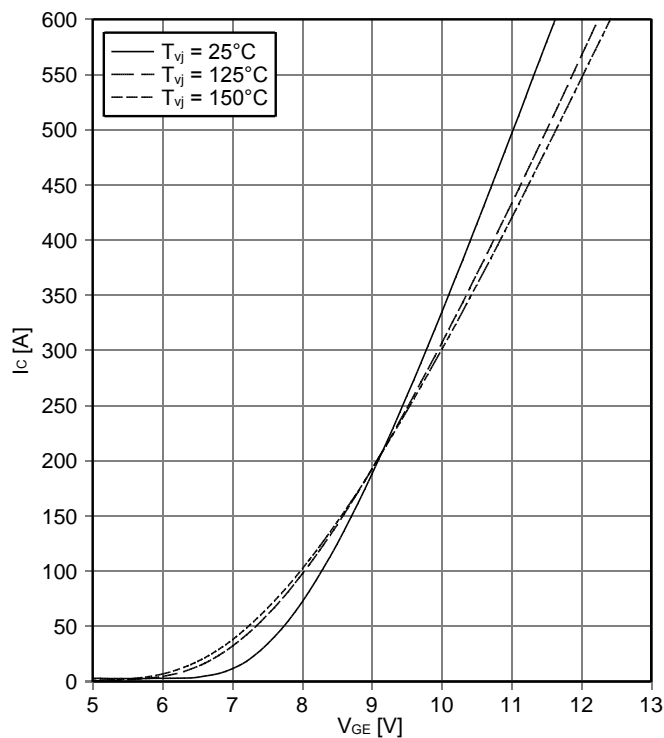

switching losses IGBT, Inverter (typical)

$E_{on} = f(I_C)$ ,  $E_{off} = f(I_C)$   
 $V_{GE} = +15\text{ V} / -8\text{ V}$ ,  $R_{Gon} = 2.2\ \Omega$ ,  $R_{Goff} = 2.2\ \Omega$ ,  $V_{CE} = 600\text{ V}$

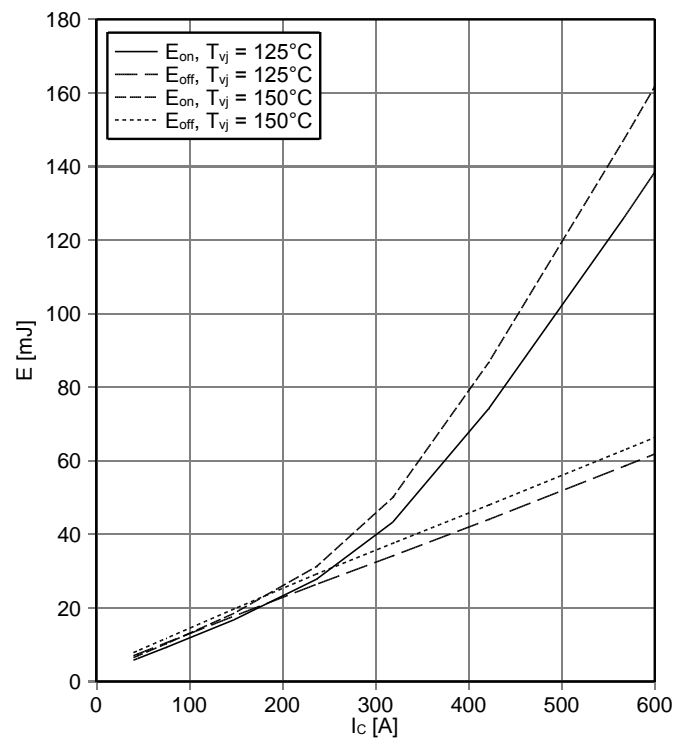

switching losses IGBT, Inverter (typical)

$E_{on} = f(R_G), E_{off} = f(R_G)$   
 $V_{GE} = +15V / -8V, I_C = 250 A, V_{CE} = 600V$

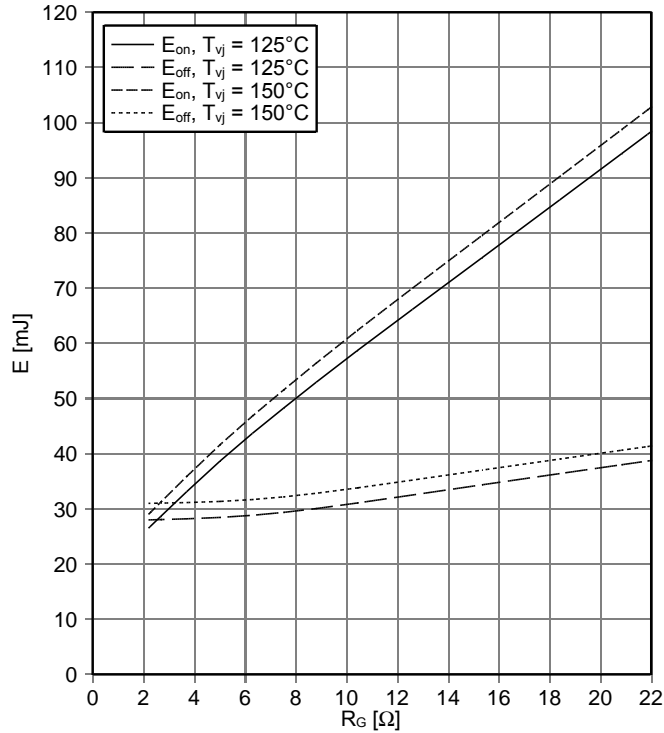

transient thermal impedance IGBT, Inverter

$Z_{thJF} = f(t), \Delta V/\Delta t = 10 \text{ dm}^3/\text{min}; 50\% \text{ water} / 50\% \text{ ethylenglycol}$   
 $T_f = 75^\circ\text{C}; \text{ cooler design according to AN-HPDPERF-ASSEMBLY}$

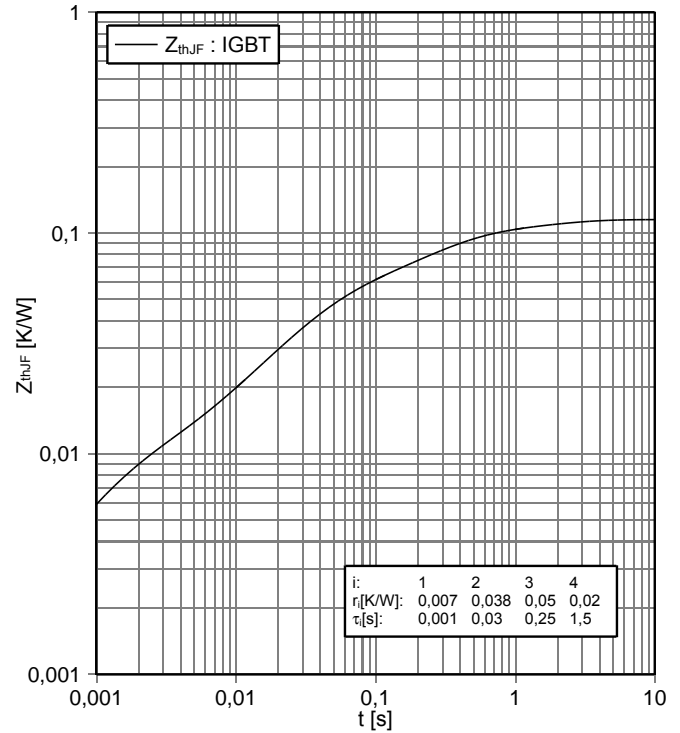

reverse bias safe operating area IGBT, Inverter (RBSOA)

$I_C = f(V_{CE});$   
 $V_{GE} = +15V / -8V, R_{Goff} = 2.2 \Omega, T_{vj} = 150^\circ\text{C}$

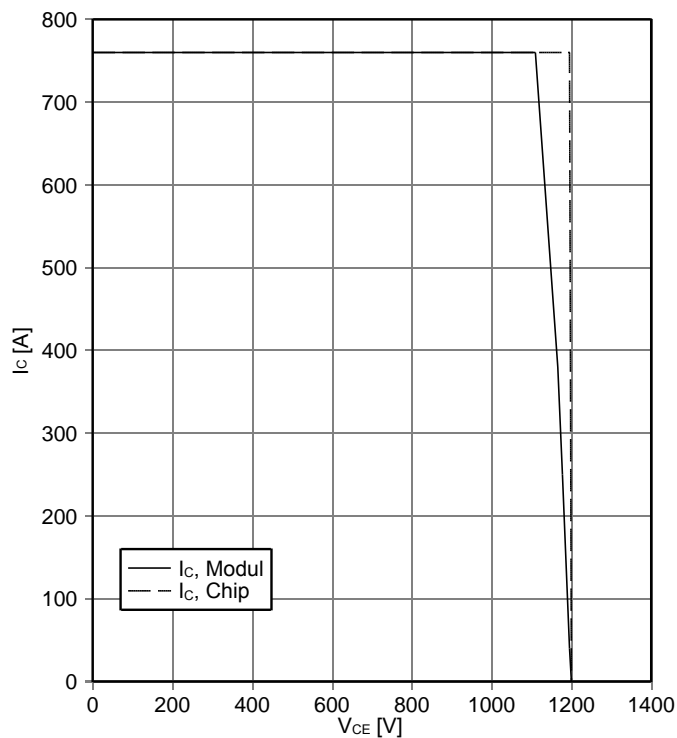

thermal impedance IGBT, Inverter

$R_{thJF} = f(\Delta V/\Delta t), T_f = 75^\circ\text{C}; 50\% \text{ water} / 50\% \text{ ethylenglycol}$   
cooler design according to AN-HPDPERF-ASSEMBLY

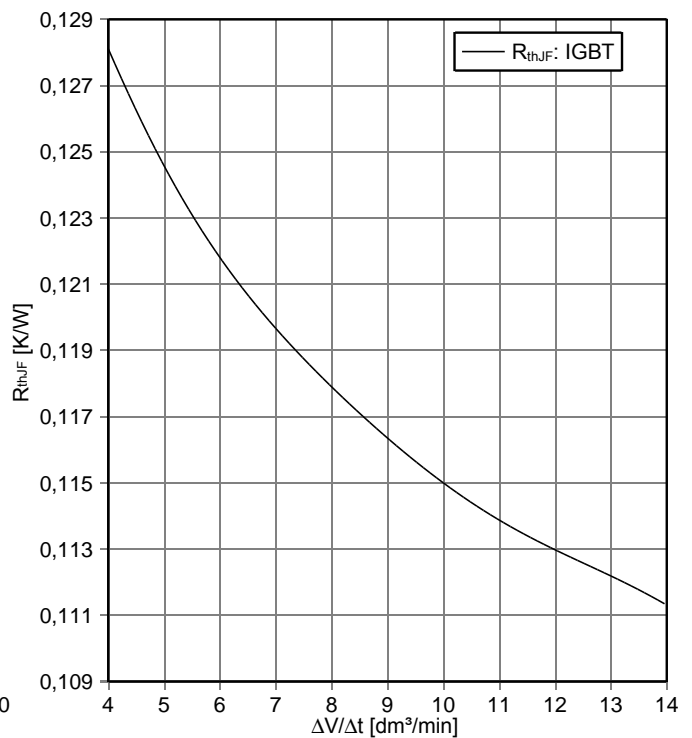

forward characteristic of Diode, Inverter (typical)  
 $I_F = f(V_F)$

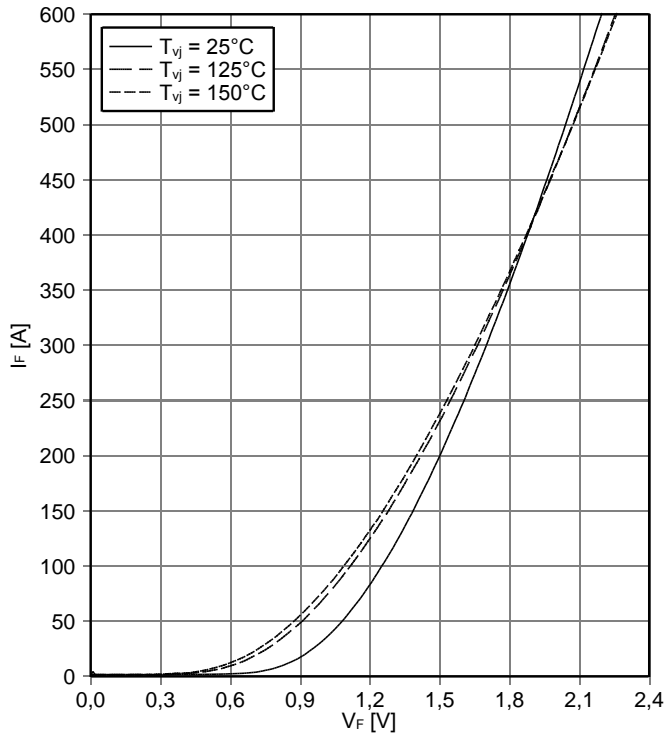

switching losses Diode, Inverter (typical)  
 $E_{rec} = f(I_F)$ ,  
 $R_{Gon} = 2.2 \Omega$ ,  $V_{CE} = 600 V$

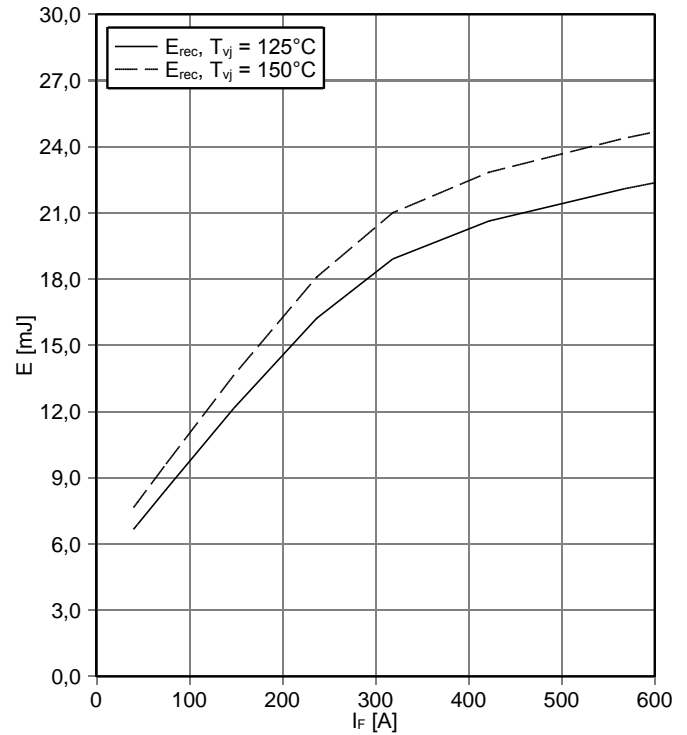

switching losses Diode, Inverter (typical)  
 $E_{rec} = f(R_G)$ ,  
 $I_F = 250 A$ ,  $V_{CE} = 600 V$

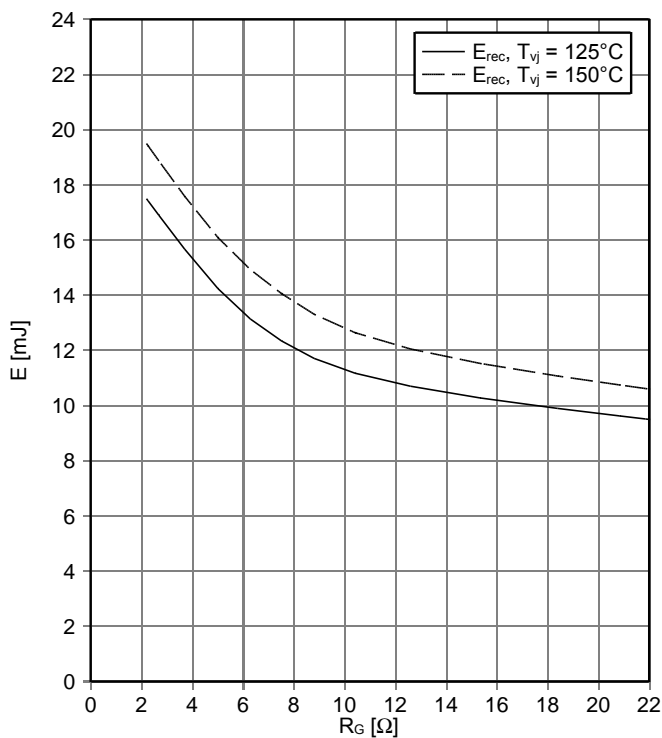

transient thermal impedance Diode, Inverter  
 $Z_{thJF} = f(t)$ ,  $\Delta V/\Delta t = 10 \text{ dm}^3/\text{min}$ ; 50% water / 50% ethylenglycol  
 $T_f = 75^\circ\text{C}$ ; cooler design according to AN-HPDPERF-ASSEMBLY

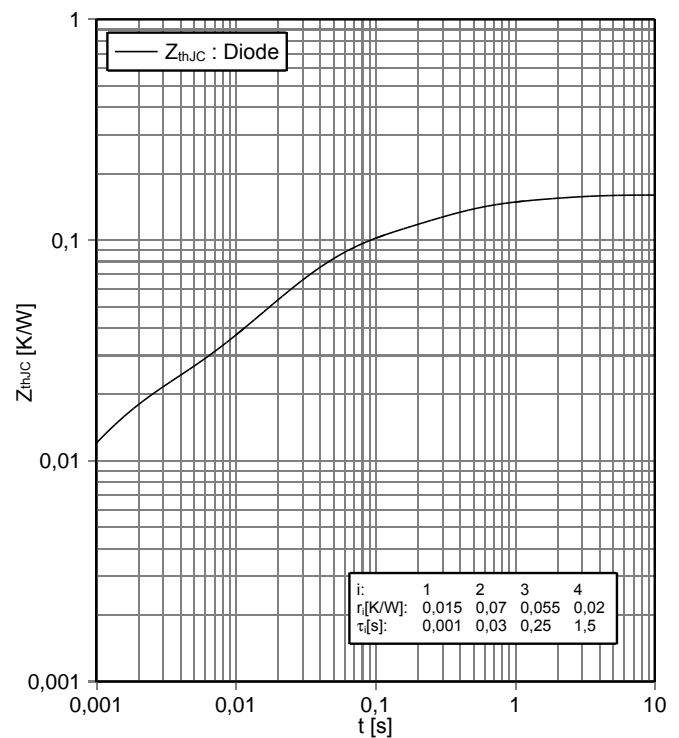



thermal impedance Diode, Inverter  
 $R_{thJF} = f(\Delta V/\Delta t)$ ,  $T_f = 75^\circ\text{C}$ ; 50% water / 50% ethylenglycol  
 cooler design according to AN-HPDPERF-ASSEMBLY

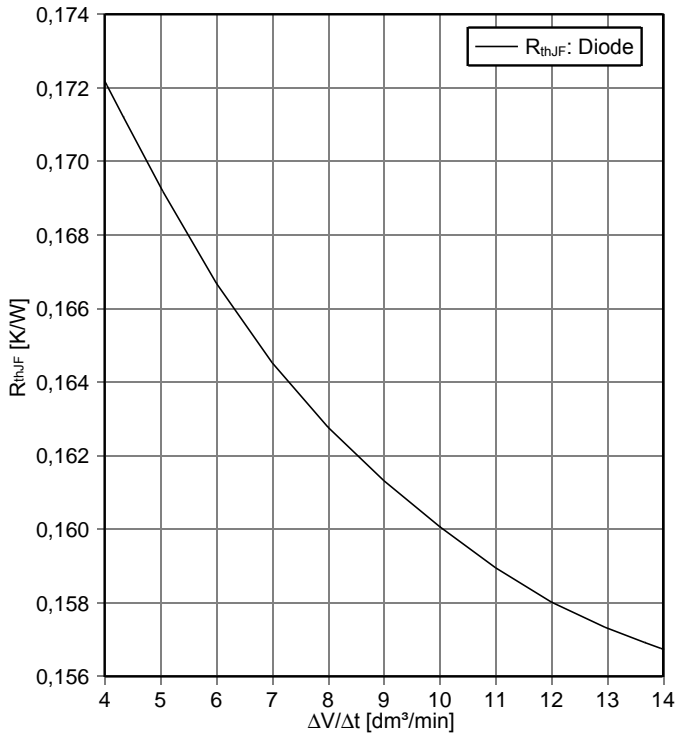

NTC-Thermistor-temperature characteristic (typical)  
 $R = f(T)$

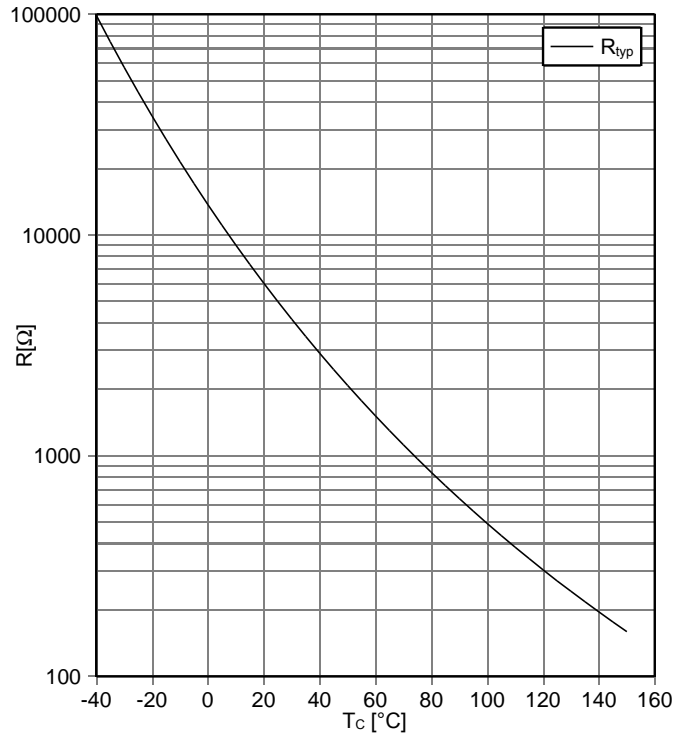

pressure drop in cooling circuit  
 $\Delta p = f(\Delta V/\Delta t)$ ,  $T_f = 75^\circ\text{C}$ ; 50% water / 50% ethylenglycol  
 cooler design according to AN-HPDPERF-ASSEMBLY

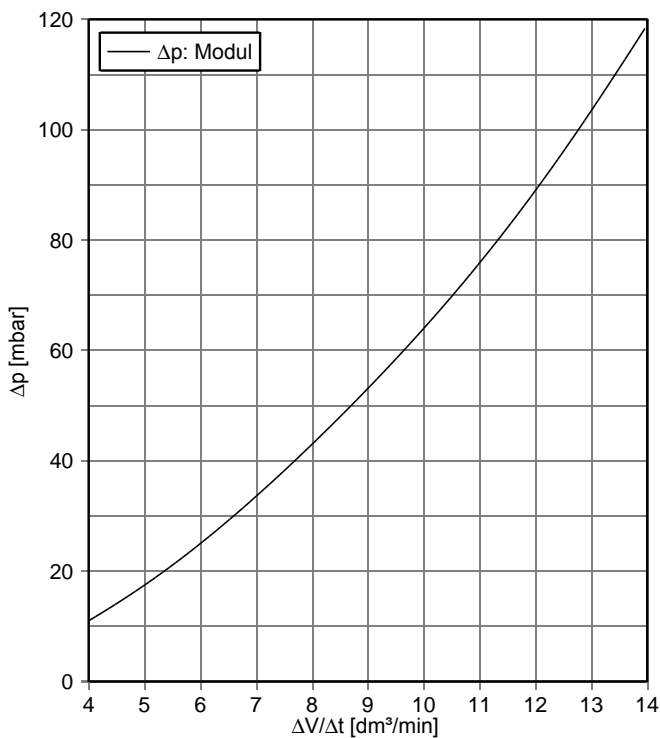

7 Circuit diagram

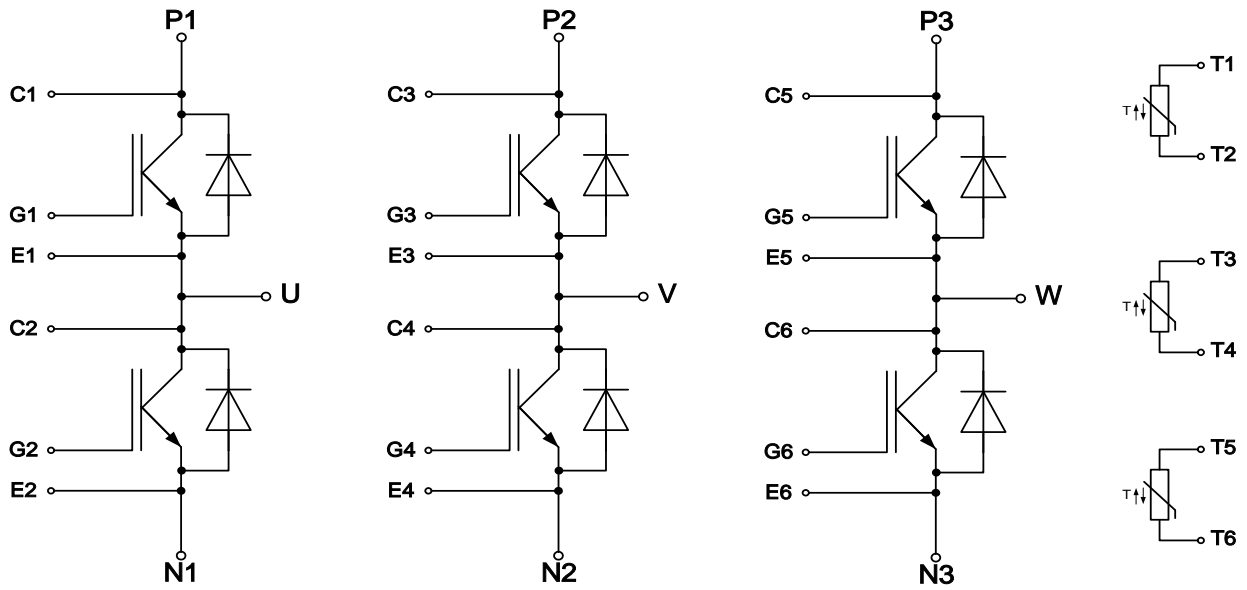



## 9 Label Codes

### 9.1 Module Code

Code Format	Data Matrix		
Encoding	ASCII Text		
Symbol Size	16x16		
Standard	IEC24720 and IEC16022		
Code Content	Content Module Serial Number Module Material Number Production Order Number Datecode (Production Year) Datecode (Production Week)	Digit 1 - 5 6 - 11 12 - 19 20 - 21 22 - 23	Example (below) 71549 142846 55054991 15 30
Example	 71549142846550549911530		

### 9.2 Packing Code

Code Format	Code128			
Encoding	Code Set A			
Symbol Size	34 digits			
Standard	IEC8859-1			
Code Content	Content Backend Construction Number Production Lot Number Serial Number Date Code Box Quantity	Identifier X 1T S 9D Q	Digit 2 - 9 12 - 19 21 - 25 28 - 31 33 - 34	Example (below) 95056609 2X0003E0 754389 1139 15
Example	 X950566091T2X0003E0S754389D1139Q15			

## Revision History

Major changes since previous revision

Revision History		
Reference	Date	Description
V1.0	2017-05-11	Target datasheet
V2.0	2018-08-27	Preliminary datasheet
V3.0	2019-05-09	Final datasheet
V3.1	2019-09-10	Correction of product weight and document cross references

## Terms & Conditions of usage

Edition 2018-08-01

Published by  
Infineon Technologies AG  
81726 Munich, Germany  
© 2018 Infineon Technologies AG  
All Rights Reserved.

### Legal Disclaimer

The information given in this document shall in no event be regarded as a guarantee of conditions or characteristics. With respect to any examples or hints given herein, any typical values stated herein and/or any information regarding the application of the device, Infineon Technologies hereby disclaims any and all warranties and liabilities of any kind, including without limitation, warranties of non-infringement of intellectual property rights of any third party.

### Information

For further information on technology, delivery terms and conditions and prices, please contact the nearest Infineon Technologies Office (<http://www.infineon.com>)

### Warnings

Due to technical requirements, components may contain dangerous substances. For information on the types in question, please contact the nearest Infineon Technologies Office.

These components are not designed for "special applications" that demand extremely high reliability or safety such as aerospace, defense or life support devices or systems (Class III medical devices). If you intend to use the components in any of these special applications, please contact your local representative at International Rectifier HiRel Products, Inc. or the Infineon support (<https://www.infineon.com/support>) to review product requirements and reliability testing.

Infineon Technologies components may be used in special applications only with the express written approval of Infineon Technologies. Class III medical devices are intended to be implanted in the human body or to support and/or maintain and sustain and/or protect human life. If they fail, it is reasonable to assume that the health of the user or other persons may be endangered.

## Trademarks

### Trademarks of Infineon Technologies AG

AURIX™, C166™, CanPAK™, CIPOS™, CIPURSE™, EconoPACK™, CoolMOS™, CoolSET™, CORECONTROL™, CROSSAVE™, DAVE™, DI-POL™, EasyPIM™, EconoBRIDGE™, EconoDUAL™, EconoPIM™, EconoPACK™, EiceDRIVER™, eupec™, FCOS™, HITFET™, HybridPACK™, I<sup>2</sup>RFT™, ISOFACE™, IsoPACK™, MIPAQ™, ModSTACK™, my-d™, NovalithIC™, OptiMOS™, ORIGA™, POWERCODE™, PRIMARION™, PrimePACK™, PrimeSTACK™, PRO-SIL™, PROFET™, RASIC™, ReverSave™, SatRIC™, SIEGET™, SINDRION™, SIPMOST™, SmartLEWIS™, SOLID FLASH™, TEMPFET™, thinQ!™, TRENCHSTOP™, TriCore™.

### Other Trademarks

Advance Design System™ (ADS) of Agilent Technologies, AMBA™, ARM™, MULTI-ICE™, KEIL™, PRIMECELL™, REALVIEW™, THUMB™, μVision™ of ARM Limited, UK. AUTOSAR™ is licensed by AUTOSAR development partnership. Bluetooth™ of Bluetooth SIG Inc. CAT-iq™ of DECT Forum. COLOSSUS™, FirstGPS™ of Trimble Navigation Ltd. EMV™ of EMVCo, LLC (Visa Holdings Inc.). EPCOS™ of Epcos AG. FLEXGO™ of Microsoft Corporation. FlexRay™ is licensed by FlexRay Consortium. HYPERTERMINAL™ of Hilgraeve Incorporated. IEC™ of Commission Electrotechnique Internationale. IrDA™ of Infrared Data Association Corporation. ISO™ of INTERNATIONAL ORGANIZATION FOR STANDARDIZATION. MATLAB™ of MathWorks, Inc. MAXIM™ of Maxim Integrated Products, Inc. MICROTEC™, NUCLEUS™ of Mentor Graphics Corporation. MIPI™ of MIPI Alliance, Inc. MIPS™ of MIPS Technologies, Inc., USA. muRata™ of MURATA MANUFACTURING CO., MICROWAVE OFFICE™ (MWO) of Applied Wave Research Inc., OmniVision™ of OmniVision Technologies, Inc. Openwave™ Openwave Systems Inc. RED HAT™ Red Hat, Inc. RFMD™ RF Micro Devices, Inc. SIRIUS™ of Sirius Satellite Radio Inc. SOLARIS™ of Sun Microsystems, Inc. SPANSION™ of Spansion LLC Ltd. Symbian™ of Symbian Software Limited. TAIYO YUDEN™ of Taiyo Yuden Co. TEAKLITE™ of CEVA, Inc. TEKTRONIX™ of Tektronix Inc. TOKO™ of TOKO KABUSHIKI KAISHA TA. UNIX™ of X/Open Company Limited. VERILOG™, PALLADIUM™ of Cadence Design Systems, Inc. VLYNQ™ of Texas Instruments Incorporated. VXWORKS™, WIND RIVER™ of WIND RIVER SYSTEMS, INC. ZETEX™ of Diodes Zetex Limited.

Last update

2011-11-11