



TAOGLAS®



Datasheet

Freedom

Part No:
FXP831.07.0100C

Description:

FXP.831 Freedom 2.4/4.9-6GHz Ground Coupled Antenna

Features:

- Flexible Ultra Low Profile
- Adheres directly to inside of product plastic or glass housing
- Dipole Antenna
- Form factor and cable routing convenient for integration
- High Efficiency
- Cable: 100mm of \varnothing 1.37mm
- Connector: IPEX MHF Connector (U.FL compatible)
- RoHS & Reach Compliant



1. Introduction	3
2. Specifications	4
3. Electrical Characteristic	5
4. Radiation Patterns	9
5. Mechanical Drawing	17
6. Precautions for usage	18
7. Packaging	19
<hr/>	
Changelog	20

Taoglas makes no warranties based on the accuracy or completeness of the contents of this document and reserves the right to make changes to specifications and product descriptions at any time without notice. Taoglas reserves all rights to this document and the information contained herein. Reproduction, use or disclosure to third parties without express permission is strictly prohibited.



1. Introduction



The FXP831 is a high efficiency, small, dual-band, dipole antenna for 2.4/4.9-6GHz band including DSRC, V2V, WiFi, Bluetooth, Zigbee and other applications in these bands. The FXP.831 has a peak gain of 2.5dBi at 2.4GHz and efficiencies of 56%, and 4.5dBi and 55% along bands 4.9GHz to 6GHz.

This Taoglas patent granted antenna is unique in the market because it is made from poly-flexible material, has a tiny form factor (45*7*.01mm) and has double-sided 3M tape for easy “peel and stick” mounting. The cable routes conveniently directly out of the bottom of the antenna, reducing the volume the antenna takes up in the device to an absolute minimum compared to other designs. The FXP.831 is the ideal all-round antenna solution for squeezing into narrow spaces and still maintaining high performance, for example on the inside top or adjacent side applied directly to the plastic housing of LCD devices.

Many module manufacturers specify peak gain limits for any antennas that are to be connected to that module. Those peak gain limits are based on free-space conditions. In practice, the peak gain of an antenna tested in free-space can degrade by at least 1 or 2dBi when put inside a device. So ideally you should go for a slightly higher peak gain antenna than mentioned on the module specification to compensate for this effect, giving you better performance. Upon testing of any of our antennas with your device and a selection of appropriate layout, integration technique, or cable, Taoglas can make sure any of our antennas’ peak gain will be below the peak gain limits. Taoglas can then issue a specification and/or report for the selected antenna in your device that will clearly show it complying with the peak gain limits, so you can be assured you are meeting regulatory requirements for that module.

For example, a module manufacturer may state that the antenna must have less than 2dBi peak gain, but you don’t need to select an embedded antenna that has a peak gain of less than 2dBi in free space. This will give you a less optimized solution. It is better to go for a slightly higher free-space peak gain of 3dBi or more if available. Once that antenna gets integrated into your device, performance will degrade below this 2dBi peak gain due to the effects of GND plane, surrounding components, and device housing. If you want to be absolutely sure, contact Taoglas and we will test. Choosing a Taoglas antenna with a higher peak gain than what is specified by the module manufacturer and enlisting our help will ensure you are getting the best performance possible without exceeding the peak gain limits.

The cable and connector are fully customizable, for further information contact your regional Taoglas customer support team.

2. Specifications

Electrical		
Frequency	2.4 ~ 2.5GHz,	4.9 ~ 6.0GHz
Peak Gain (free space)	2.5dBi	4.5dBi
Peak Gain (on plastic*)	3.0dBi	5.5dBi
Average Gain (free space)	-2.6dBi	-2.6dBi
Average Gain (on plastic)	-2.6dBi	-1.8dBi
Efficiency (free space)	56%	55%
Efficiency (on plastic)	56%	75%
VSWR	≤2.5 : 1	
Impedance	50 Ohms	
Polarization	Linear	
Radiation Pattern	Omni	
Input Power	2W max.	
Mechanical		
Dimensions	45mm x 7mm	
Antenna Body Material	Polymer	
Cable	Gray 100mm 1.37 co-axial	
Connector	Iplex MHF	
ENVIRONMENTAL		
Temperature Range	-40°C to 85°C	
Humidity	Non-condensing 65°C 95% RH	

3. Electrical Characteristic

3.1 S11

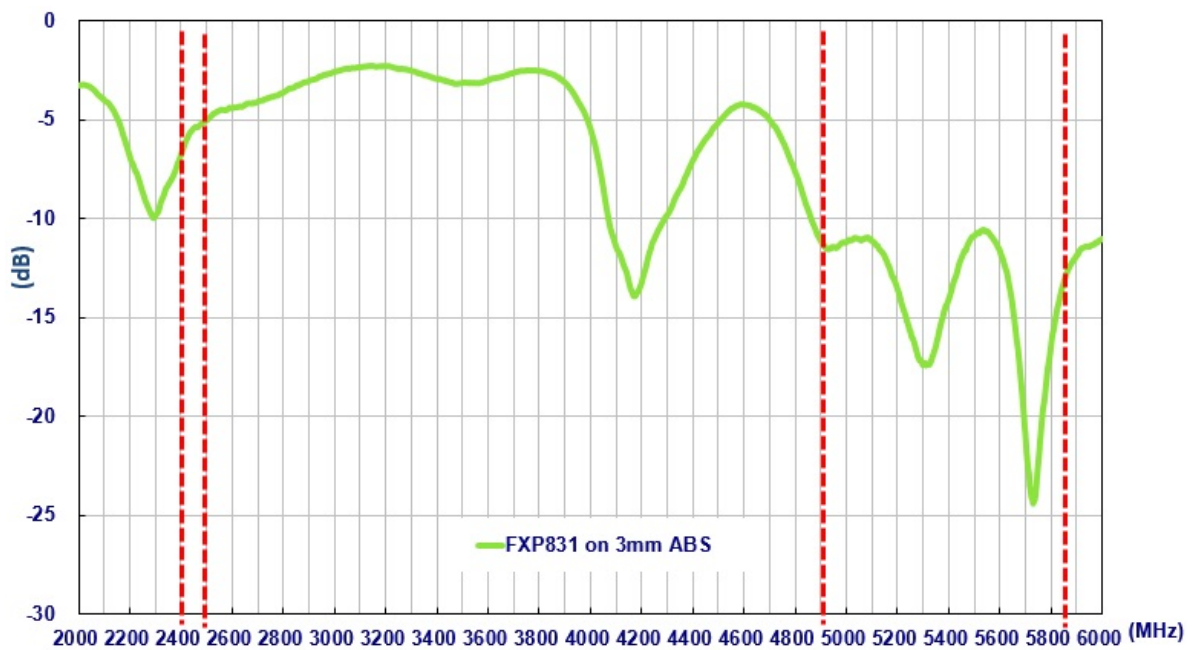
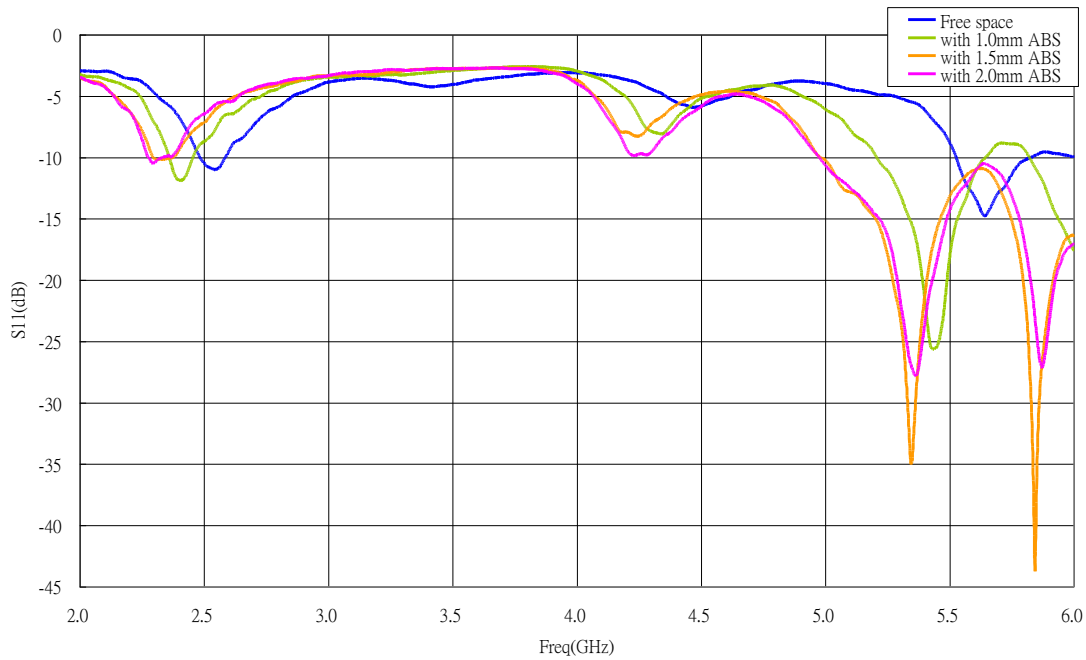

3.2 Test setup

A ETS AMS-8500 test chamber is used for the free space radiation testing for FXP831.07.0100A. The measurement is taken with the antenna properly mounted in the designated device.

Device tested in AMS-8500 Rectangular test chamber.

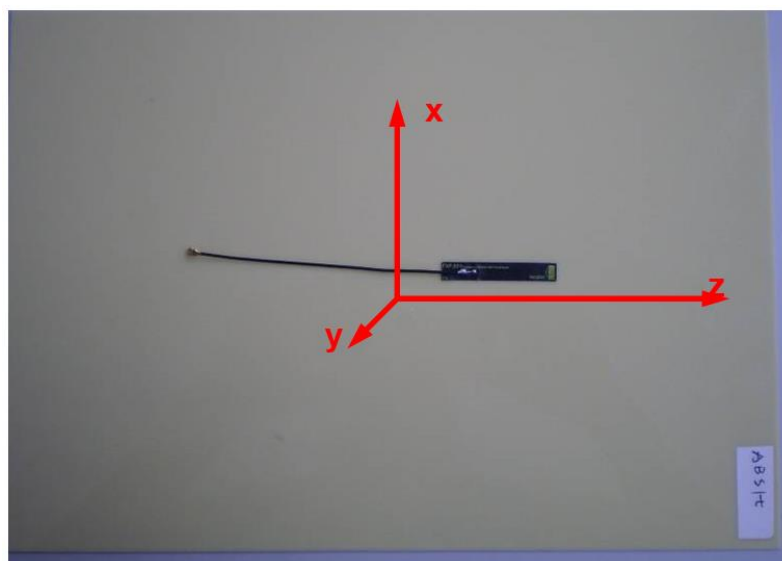
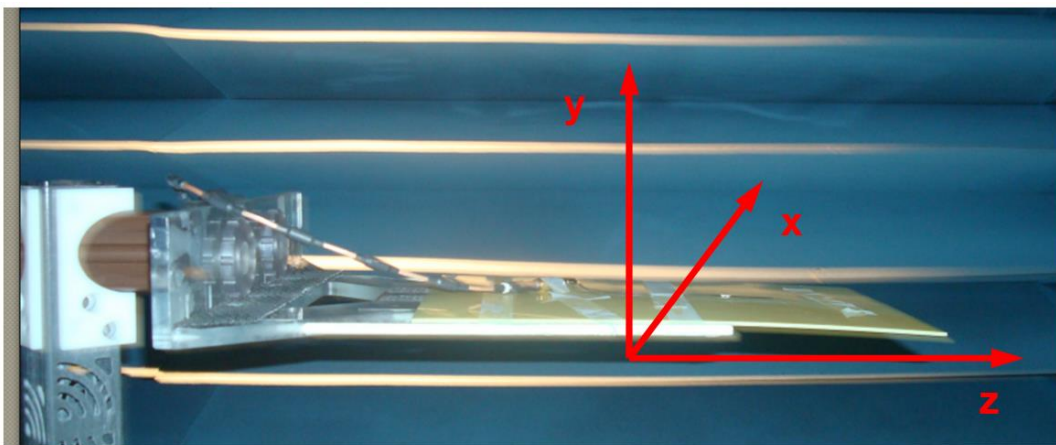

3.2 Peak Gain

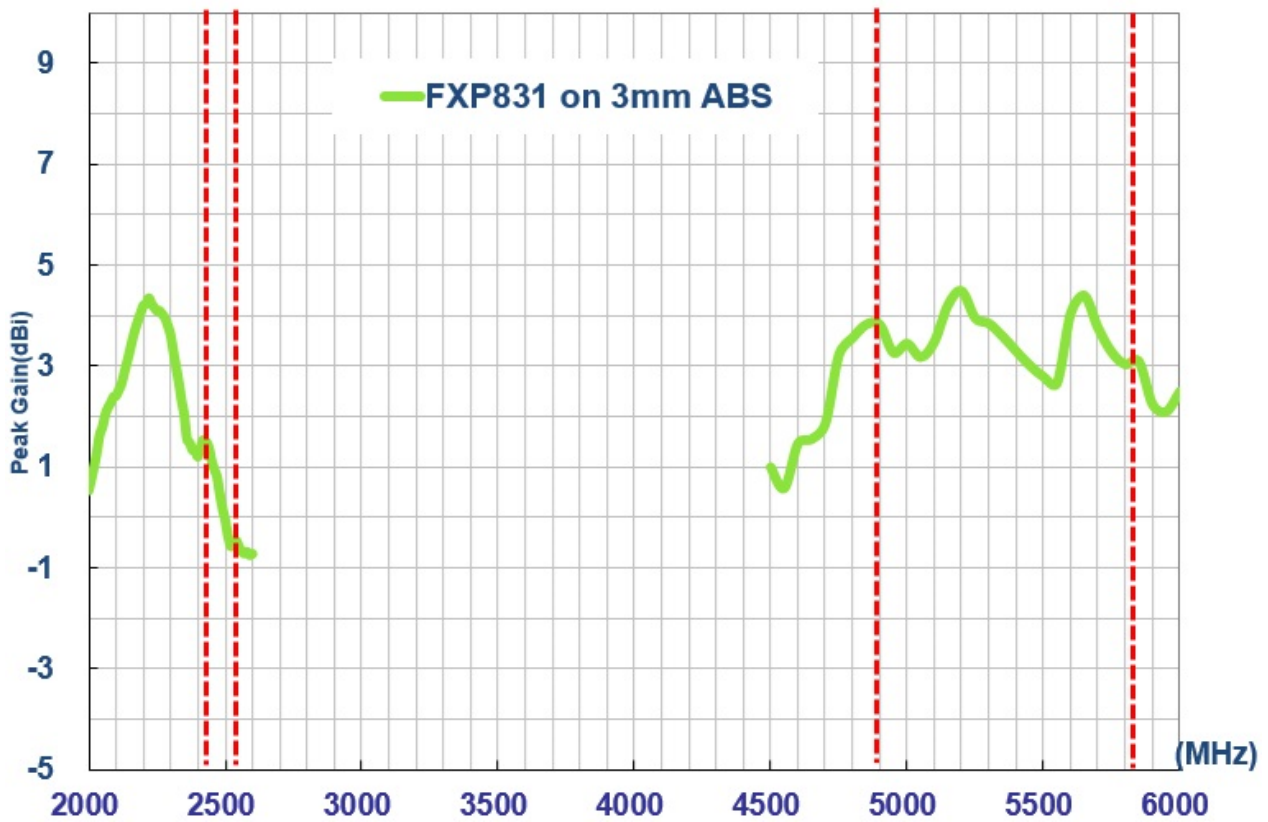
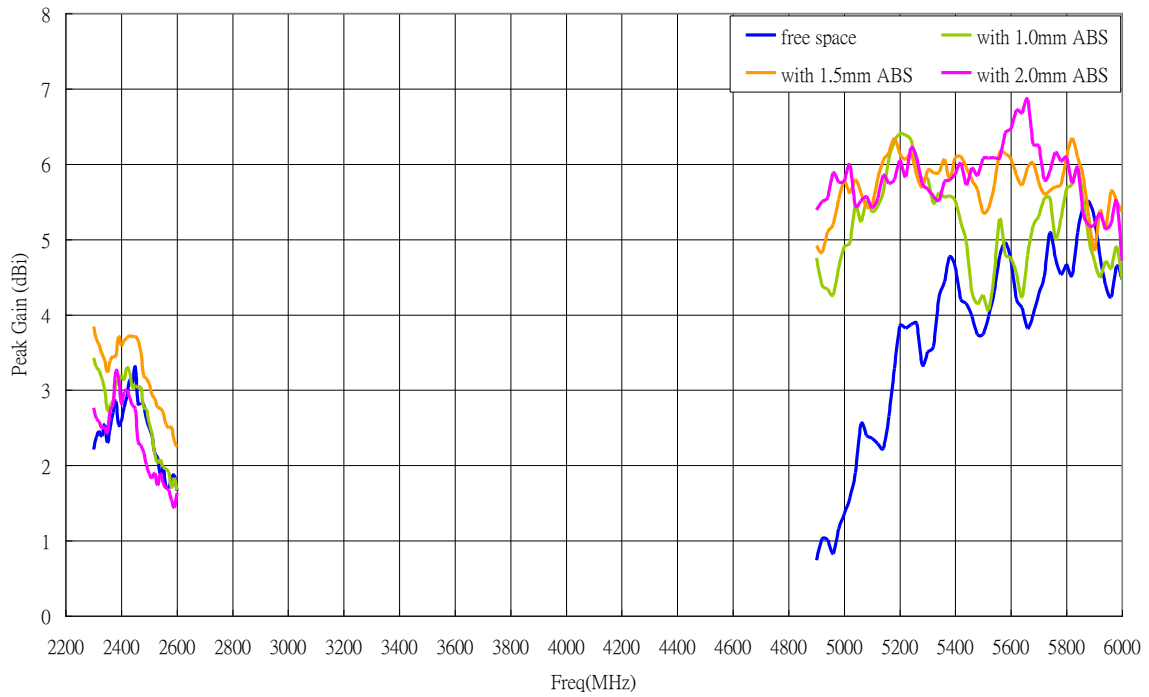

3.3 Efficiency

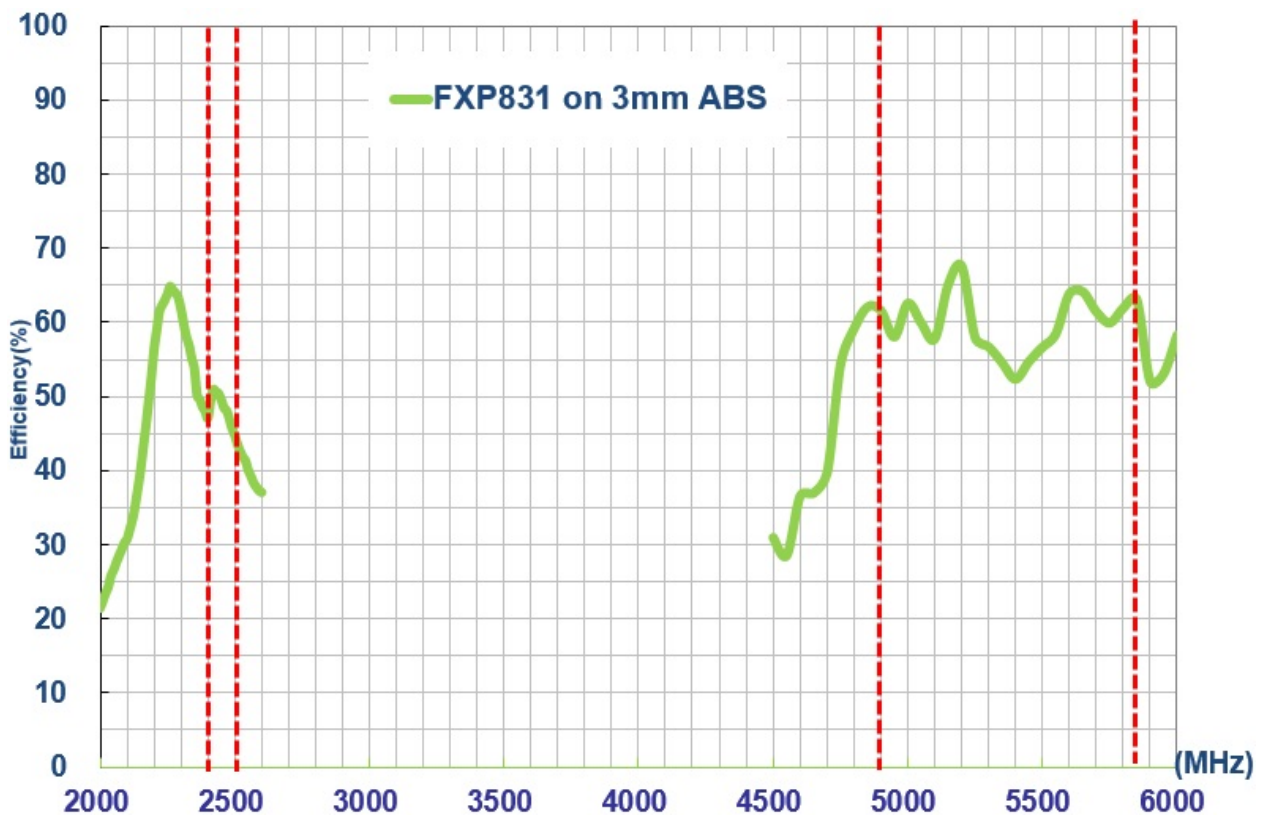
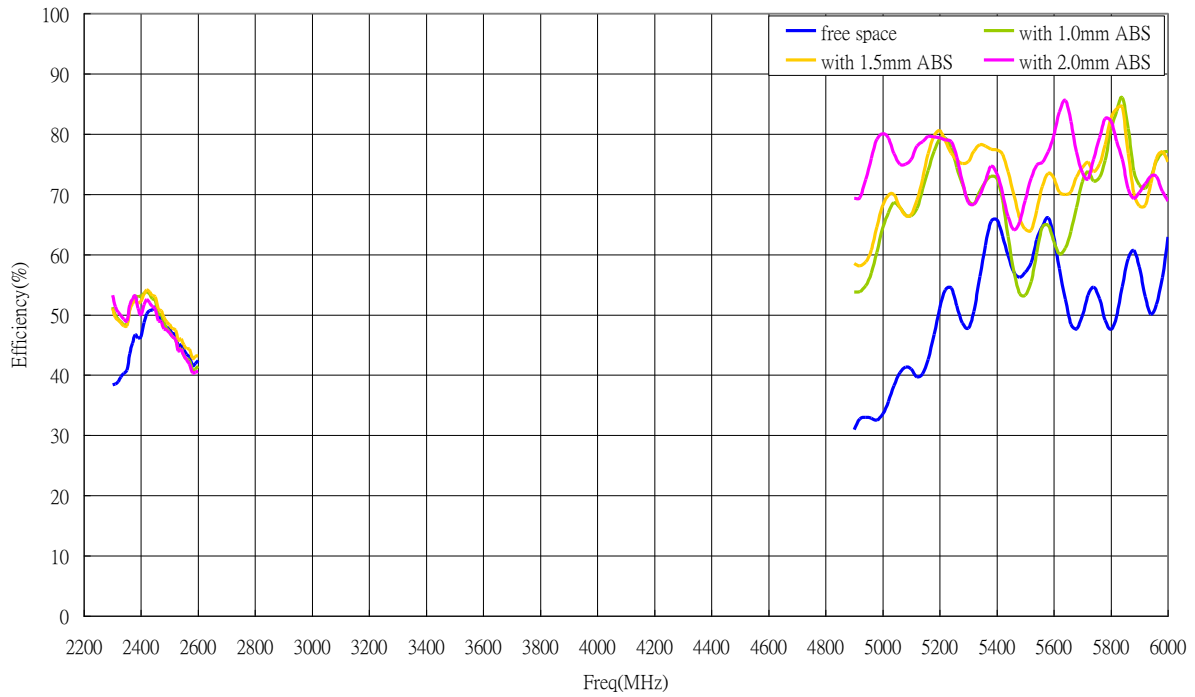

4. Radiation Patterns

XZ Plane (at 2400MHz)

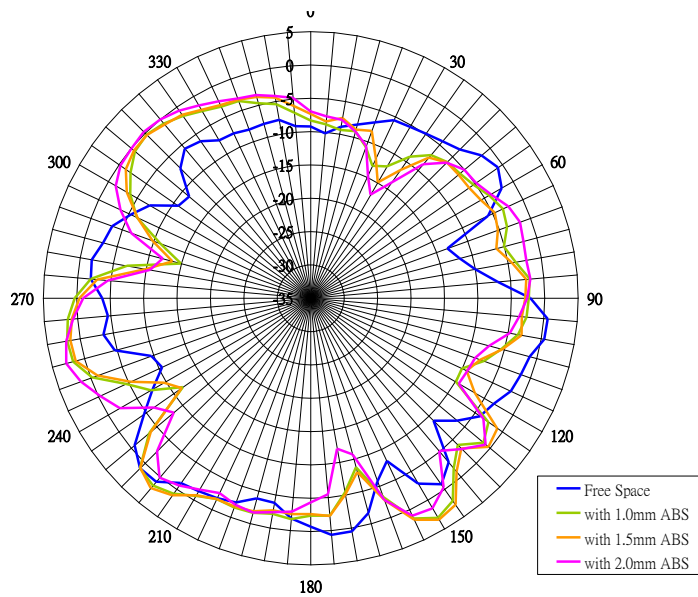

XZ Plane (at 2500MHz)

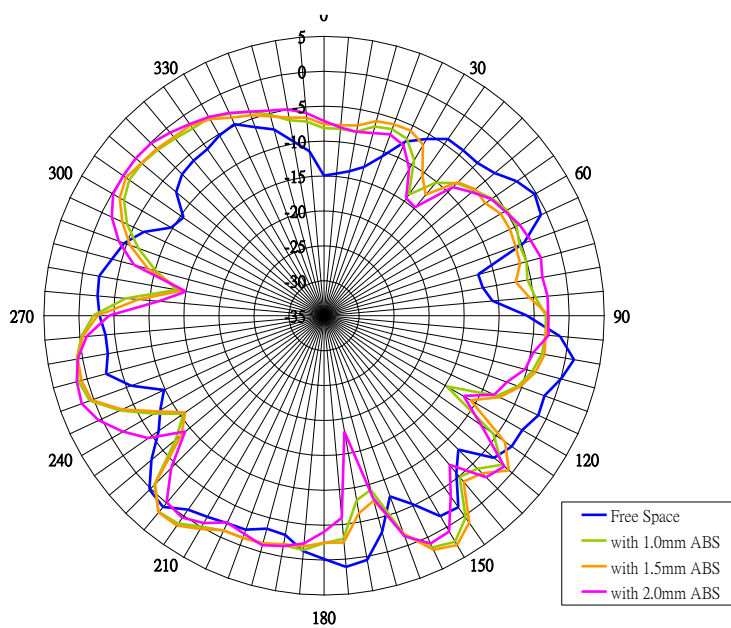

XZ Plane (at 5000MHz)

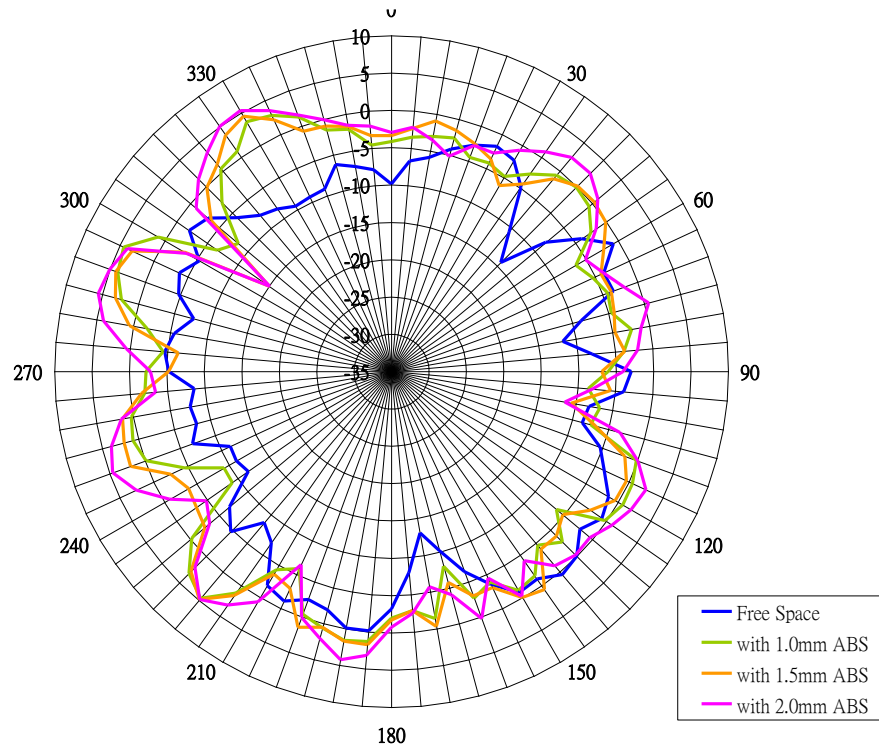

XZ Plane (at 5500MHz)

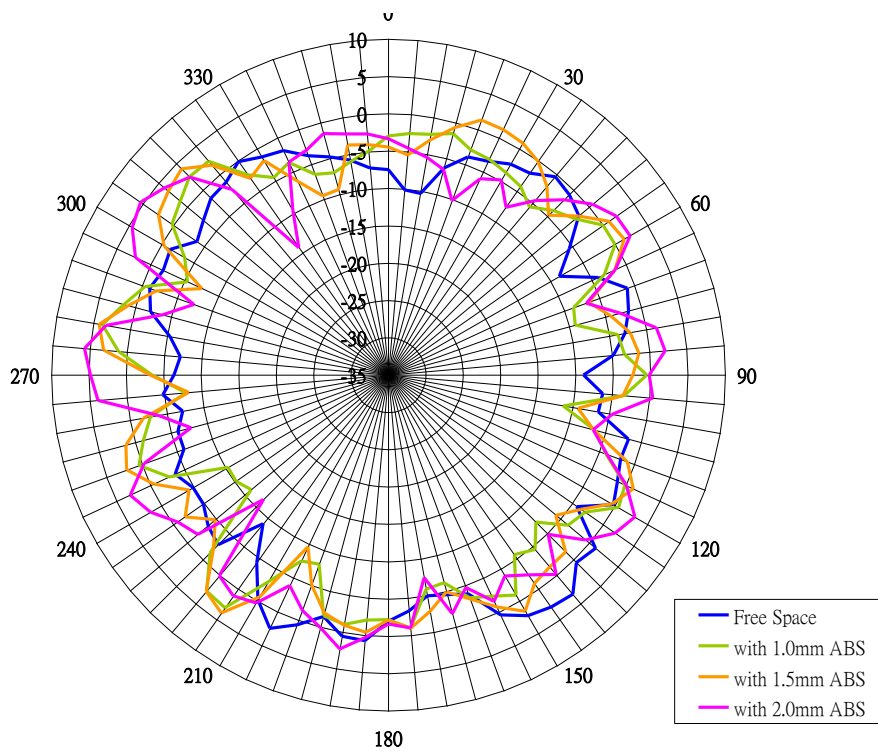

XZ Plane (at 6000MHz)

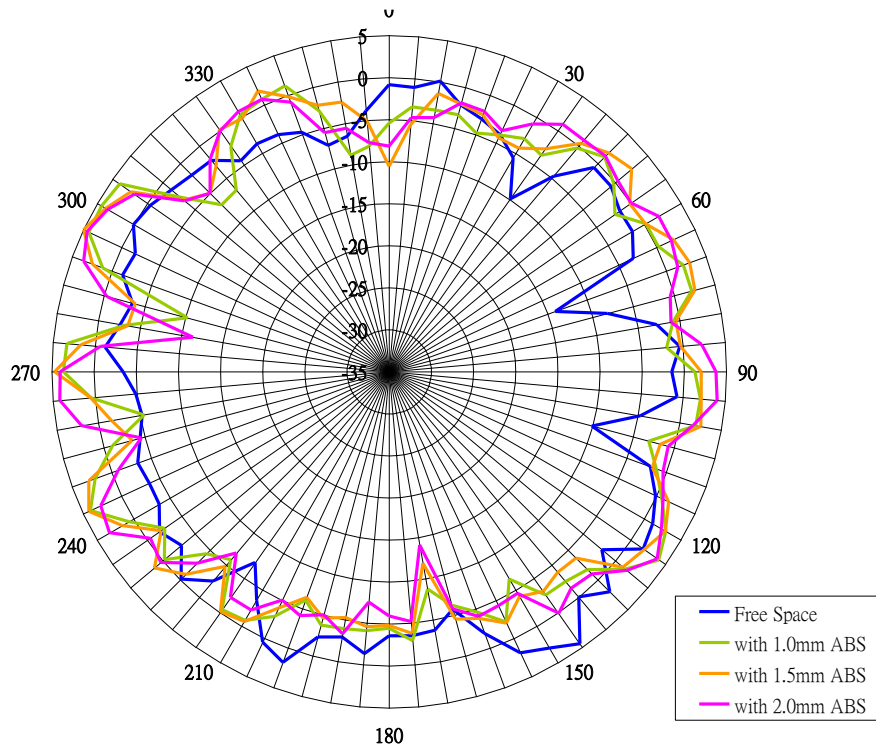

YZ Plane (at 2400MHz)

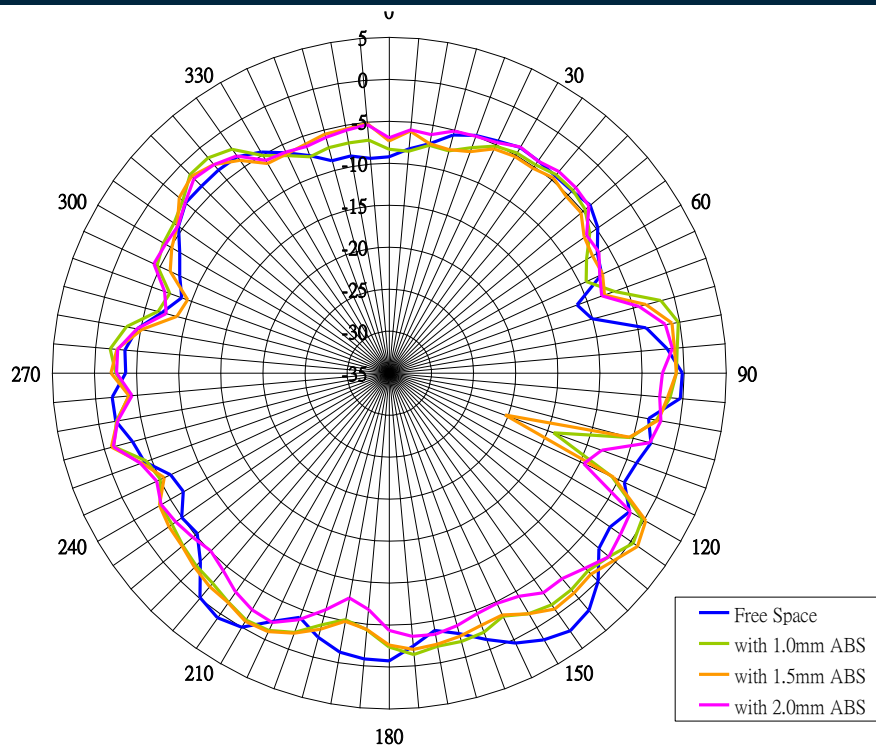

YZ Plane (at 2500MHz)

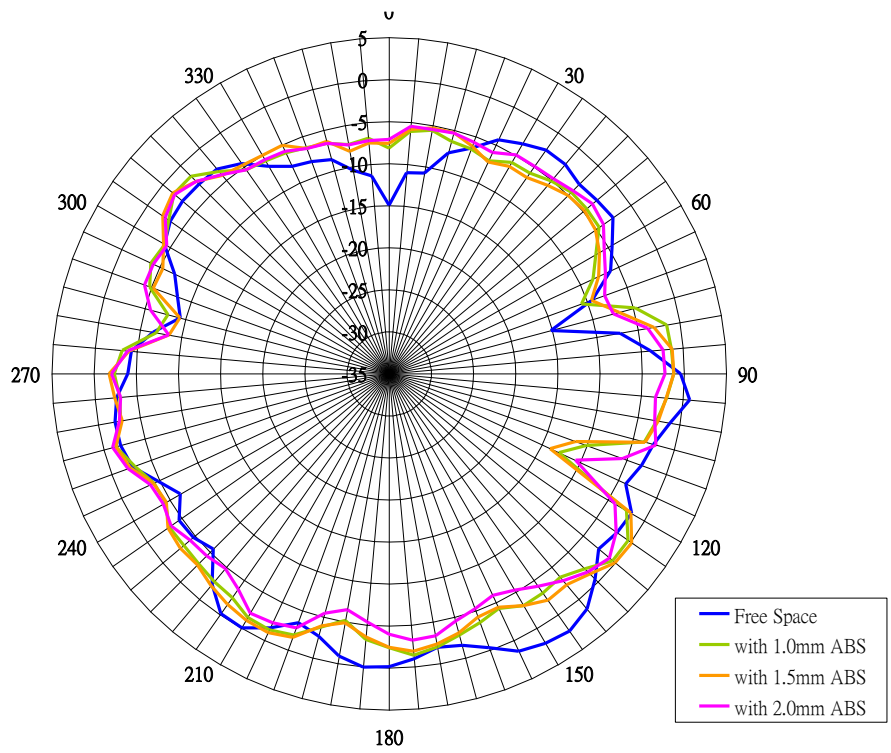

YZ Plane (at 5000MHz)

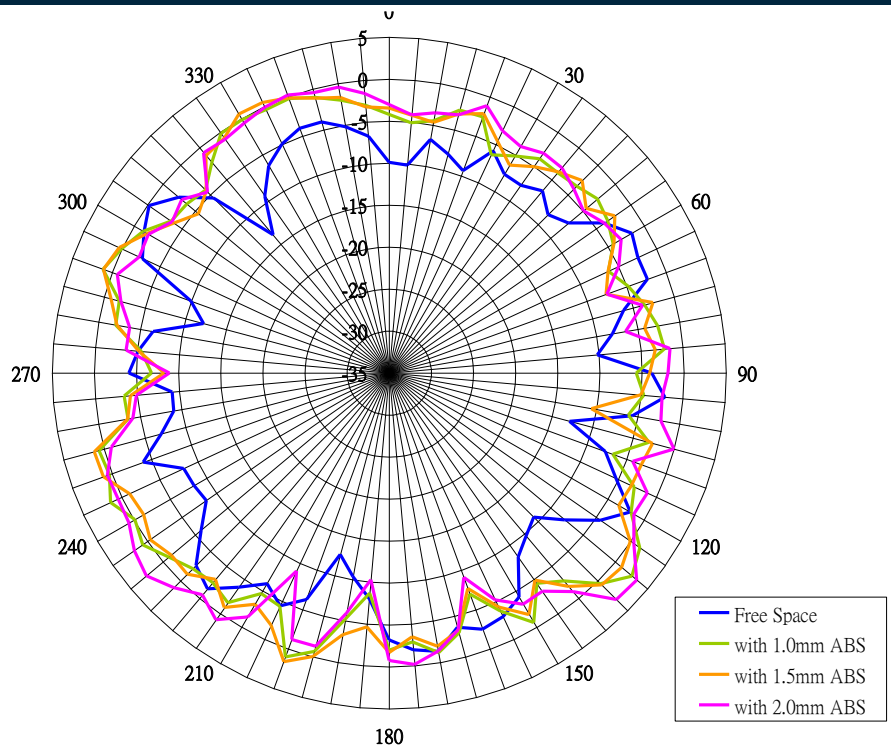

YZ Plane (at 5500MHz)

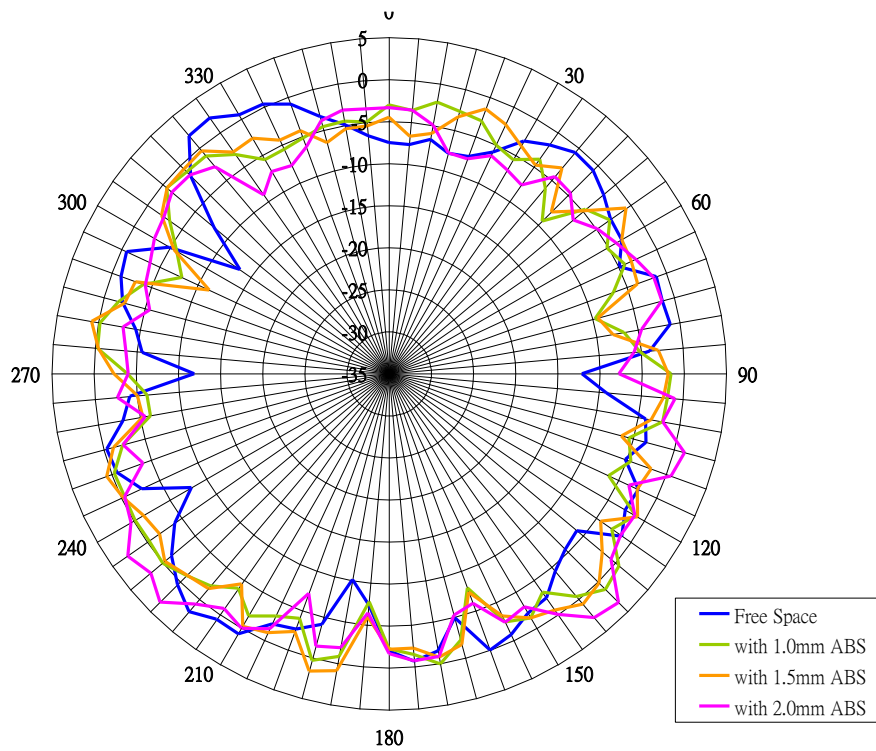

YZ Plane (at 6000MHz)

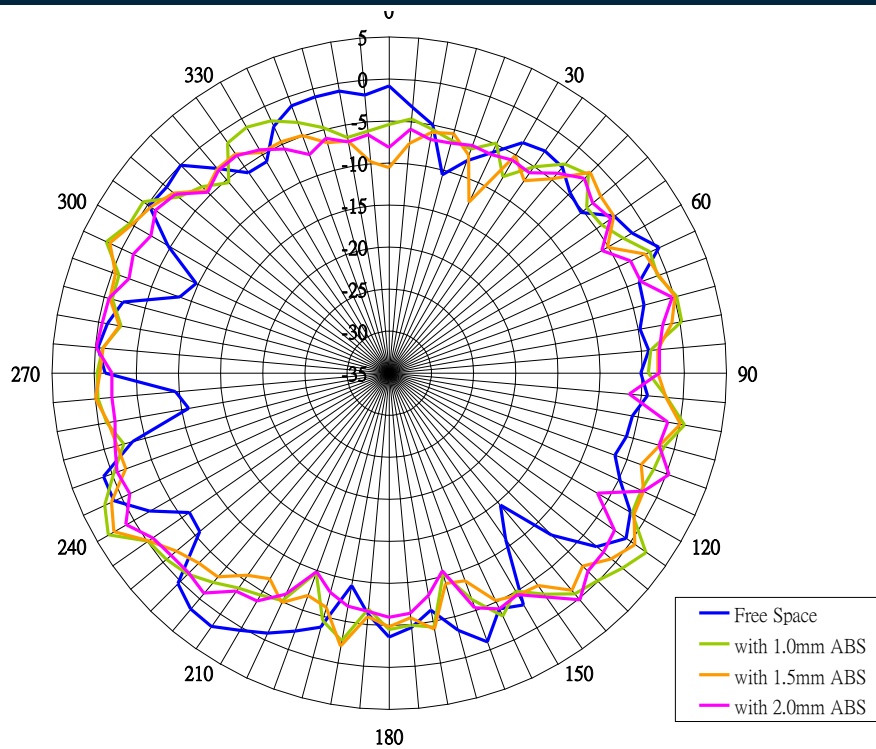

XY Plane (at 2400MHz)

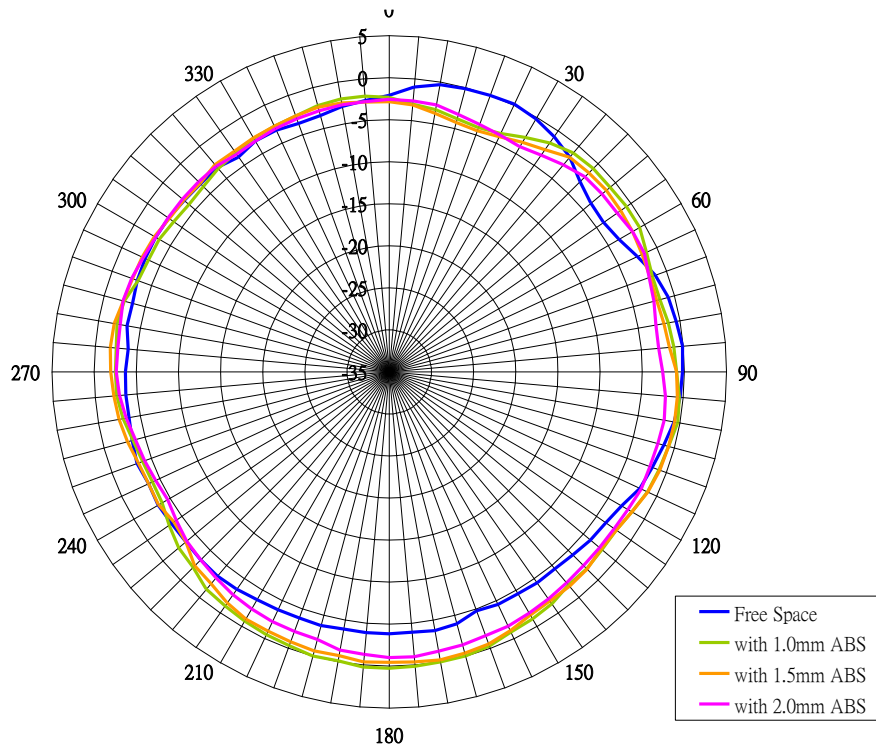

XY Plane (at 2500MHz)

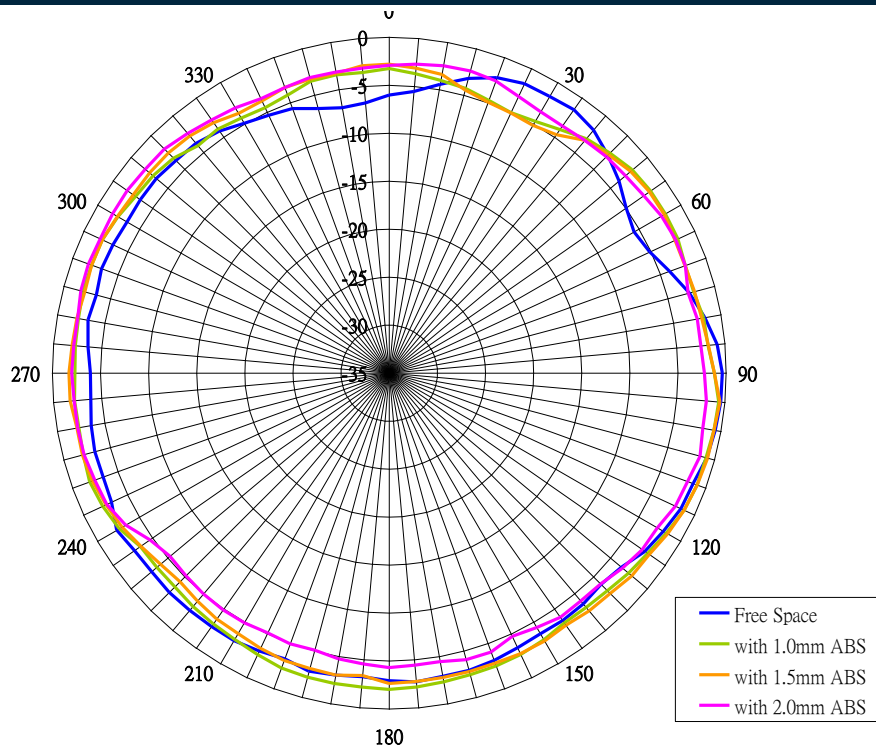

XY Plane (at 5000MHz)

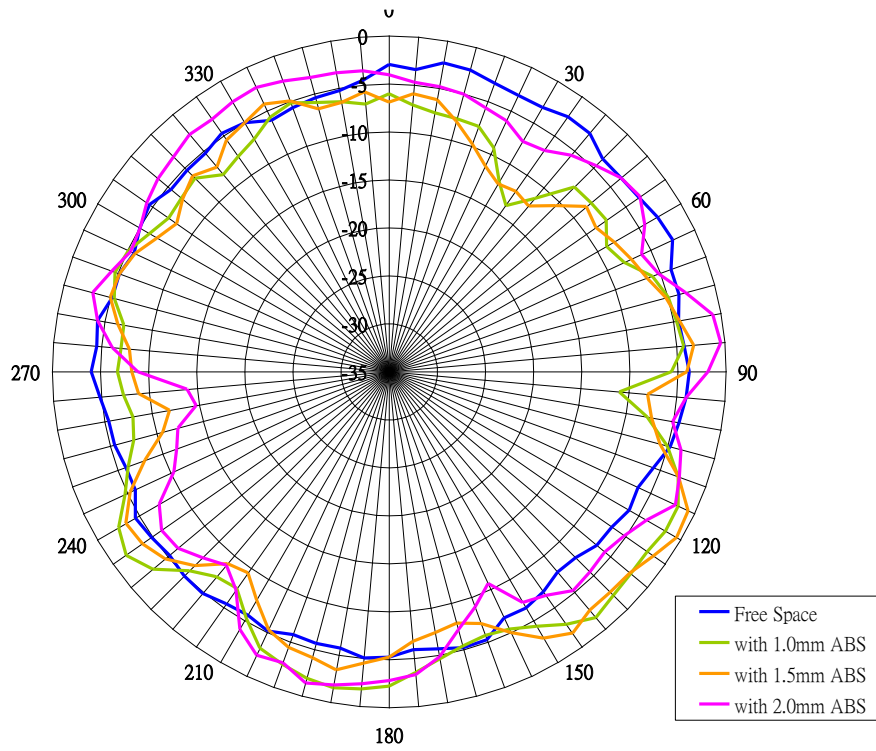

XY Plane (at 5500MHz)

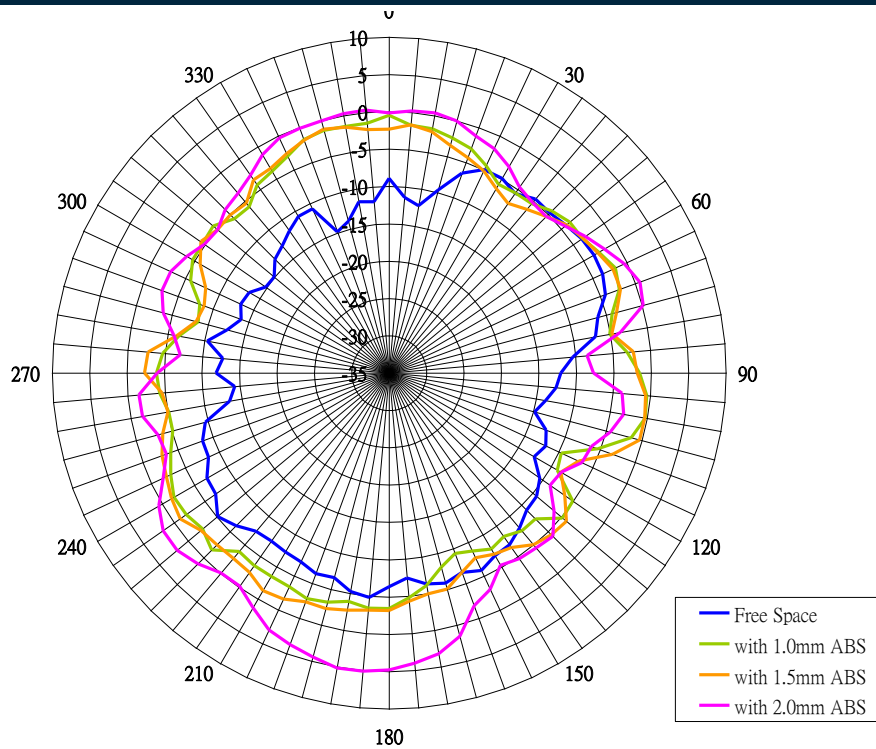

XY Plane (at 6000MHz)

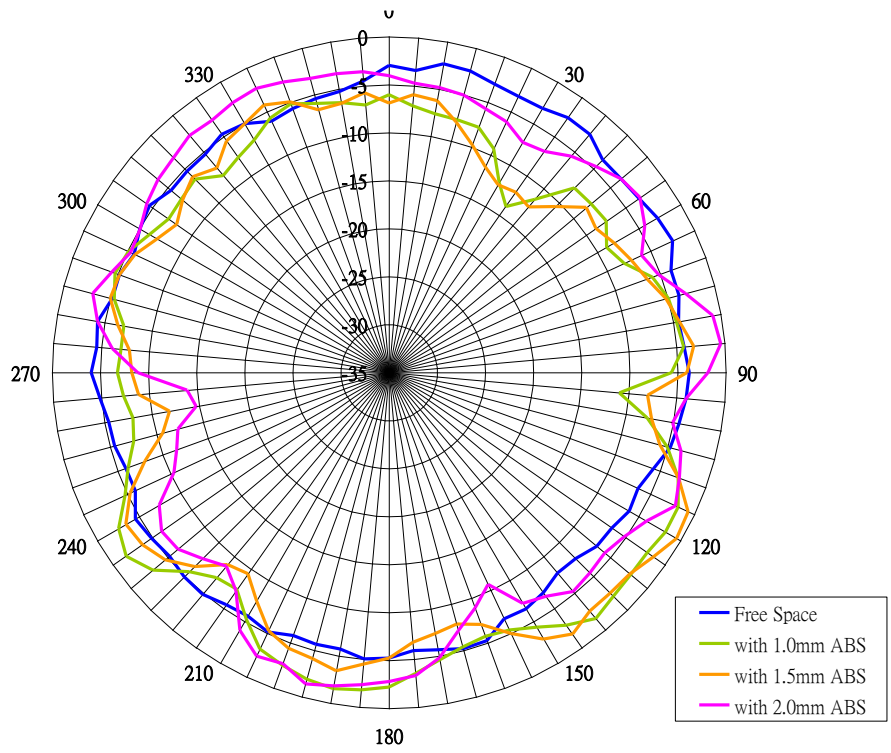

5. Mechanical Drawing (Units: mm)

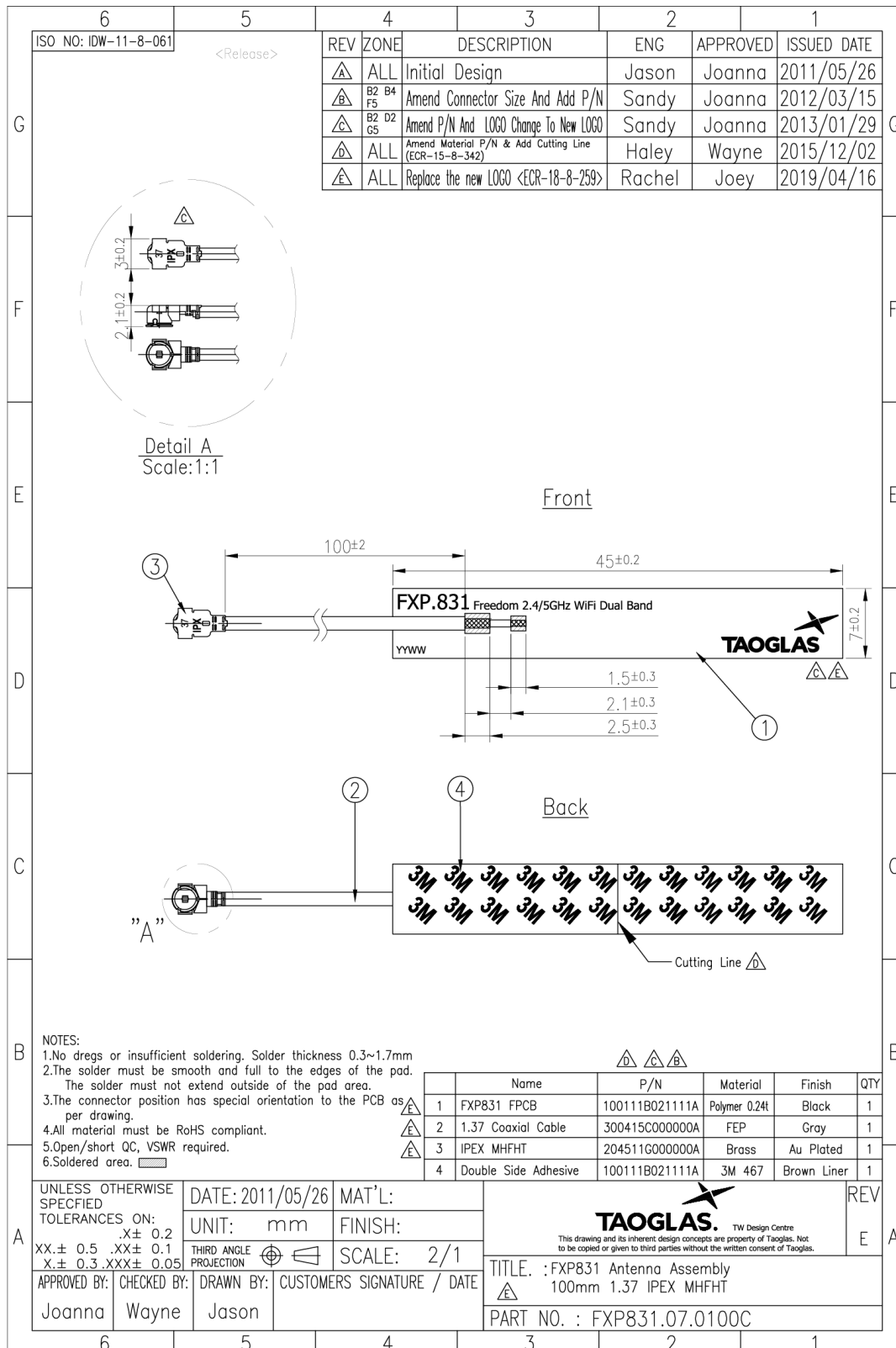

6. Precautions for usage

Mating / unmating

(1) To disconnect connectors, insert the end portion of I-PEX under the connector flanges and pull off vertically, in the direction of the connector mating axis.

(2) To mate the connectors, the mating axes of both connectors must be aligned and the connectors can be mated. The "click" will confirm fully mated connection.

Do not attempt to insert on an extreme angle.

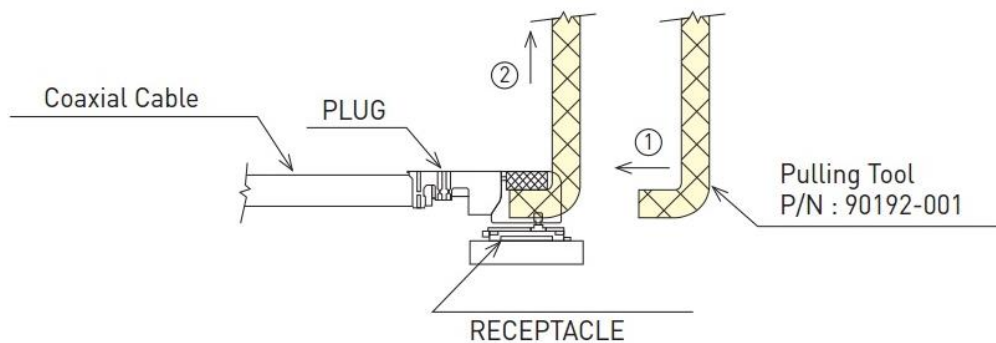

Pull forces on the cable after connectors are mated

After the connectors are mated, do not apply a load to the cable in excess of the values indicated in the diagram below.

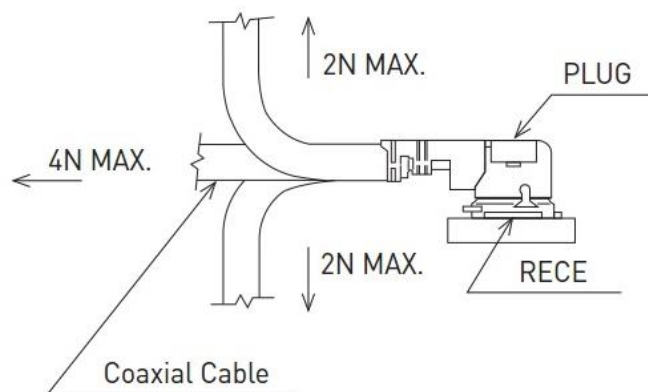

7. Packaging

100pc FXP831.07.0100C per Small PE Bag

Dimensions: 300*100mm

Weight: 70g

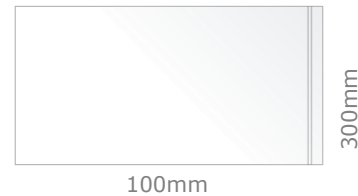
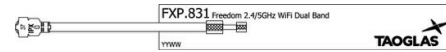

1000pcs FXP831.07.0100C per Large PE Bag

Dimensions: 430*280mm

Weight: 807g



5000pcs FXP831.07.0100C per Carton

Carton Dimensions: 320*250*230 mm

Weight: 4.5Kg

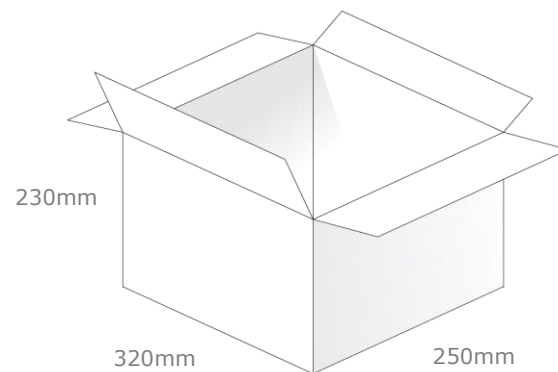

Pallet Dimensions:

1200*1000*1350mm

60 Cartons per Pallet

12 Cartons per layer, 5 Layers

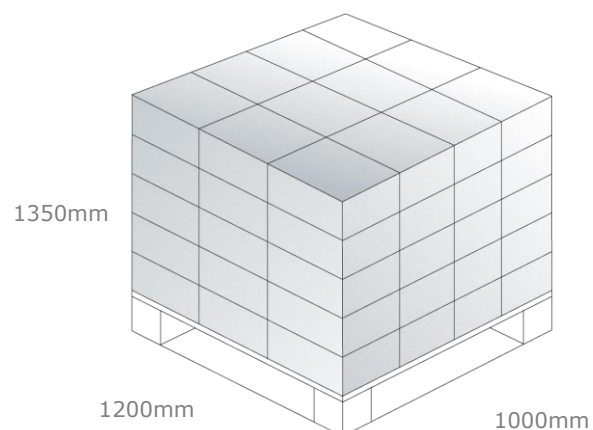

Changelog for the datasheet

SPE-11-8-037 – FXP831.07.0100C

Revision: J	
Date:	2019-03-01
Changes:	Updated specifications
Changes Made by:	Cesar Sousa

Previous Revisions

Revision: I	
Date:	2019-05-14
Changes:	Images Updated
Changes Made by:	David Connolly

Revision: D	
Date:	2014-10-04
Changes:	Added in Batch code
Changes Made by:	Aine Doyle

Revision: H	
Date:	2016-06-22
Changes:	Added patent
Changes Made by:	Aine Doyle

Revision: C	
Date:	2012-01-14
Changes:	Updated intro
Changes Made by:	Aine Doyle

Revision: G	
Date:	2015-07-09
Changes:	Specification Updated
Changes Made by:	Aine Doyle

Revision: B	
Date:	2011-07-14
Changes:	
Changes Made by:	Aine Doyle

Revision: F	
Date:	2015-06-30
Changes:	Added in DSRC
Changes Made by:	Aine Doyle

Revision: A (Original First Release)	
Date:	2011-07-01
Notes:	
Author:	Aine Doyle

Revision: E	
Date:	2015-02-15
Changes:	Added note on Intro
Changes Made by:	Aine Doyle