



TAOGLAS®



Datasheet

Freedom FXP832

Part No:
FXP832.03.0458D

Description:

FXP832 Freedom Wi-Fi 2.4GHz and 4.9-6GHz Dipole Antenna

Features:

- Flexible PCB
- Very High Efficiency
- 42mm*7mm*0.1mm
- Ground-plane Independent
- Cable: 458mm (18 inches) RG174
- Connector: RP-SMA(M) Straight
- RoHS & REACH Compliant

1. Introduction	3
2. Specifications	4
3. Antenna Characteristics	5
4. 2D Radiation Patterns	7
5. 3D Radiation Patterns	9
6. Mechanical Drawing	11
7. Packaging	12
<hr/>	
Changelog	13

Taoglas makes no warranties based on the accuracy or completeness of the contents of this document and reserves the right to make changes to specifications and product descriptions at any time without notice. Taoglas reserves all rights to this document and the information contained herein. Reproduction, use or disclosure to third parties without express permission is strictly prohibited.



1. Introduction



The Freedom FXP832 is a breakthrough, very high efficiency, small, dual-band Wi-Fi dipole omni-directional antenna for 2.4/5GHz bands. This antenna is designed for DSRC, V2V, Wi-Fi, Bluetooth, Zigbee and other applications in these bands. It is designed in such a narrow rectangular form factor to cover most of the current applications on the market. Taoglas FXP series are conformal flexible antennas and can fit irregular housings.

With dimensions of 42*7*.01mm it comes with double-sided 3M tape for easy “peel and stick” mounting. This longer cable length version of the FXP832 is ideal for applications in embedded industrial and automotive environments.

Typical Applications include:

- Automotive
- Remote Monitoring
- Security

Like all embedded omni-directional antennas, care should be taken to keep the antenna away from metal as much as possible, a minimum of 10mm is recommended.

The cable length and connector type are fully customizable, for more information contact your regional Taoglas Customer Support Team.

2. Specifications

Electrical		
Frequency (MHz)	2400-2500	4900-6000
Peak Gain (dBi)		
On 2mm ABS	3.66	5.33
Average Gain (dB)		
On 2mm ABS	-1.25	-1.89
Efficiency (%)		
On 2mm ABS	74.9	64.7
Impedance	50Ω	
Polarization	Linear	
Radiation Pattern	Omni	
Input Power	2W	
Mechanical		
Dimensions	42mm x 7mm	
Antenna Body Material	Polymer	
Cable	Black 458mm (18 inches) RG174 Coaxial Cable	
Connector	RP-SMA(M) Straight	
Weight	7.5g	
Environmental		
Temperature Range	-40°C to 85°C	
Humidity	Non-condensing 65°C 95% RH	

3. Antenna Characteristics

3.1 Return Loss

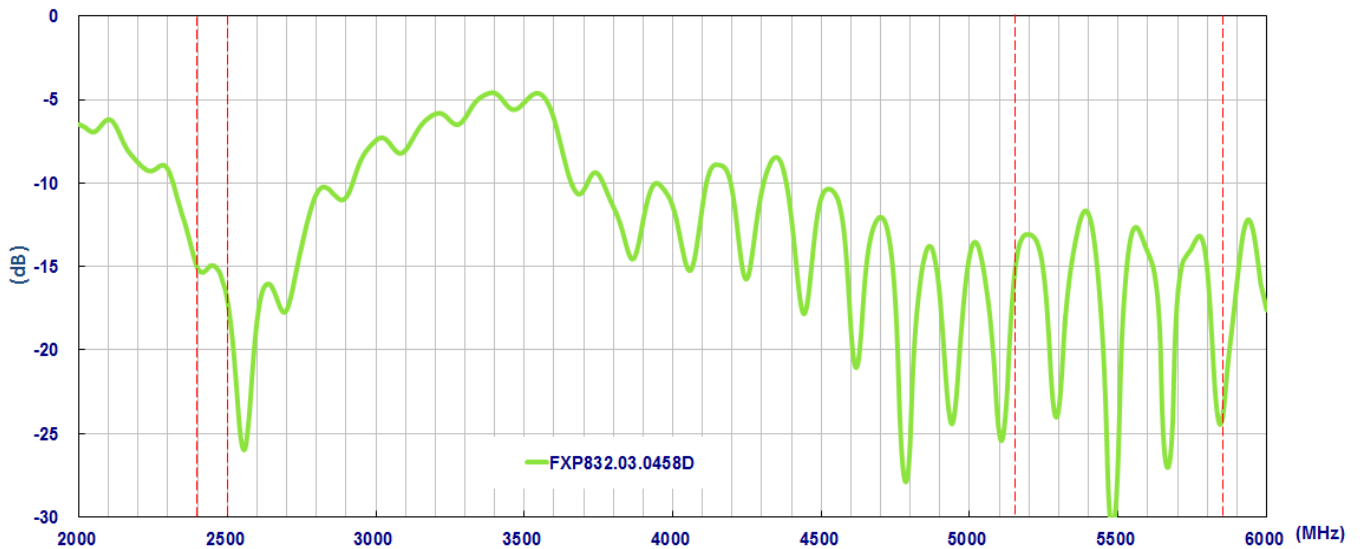

3.2 Efficiency

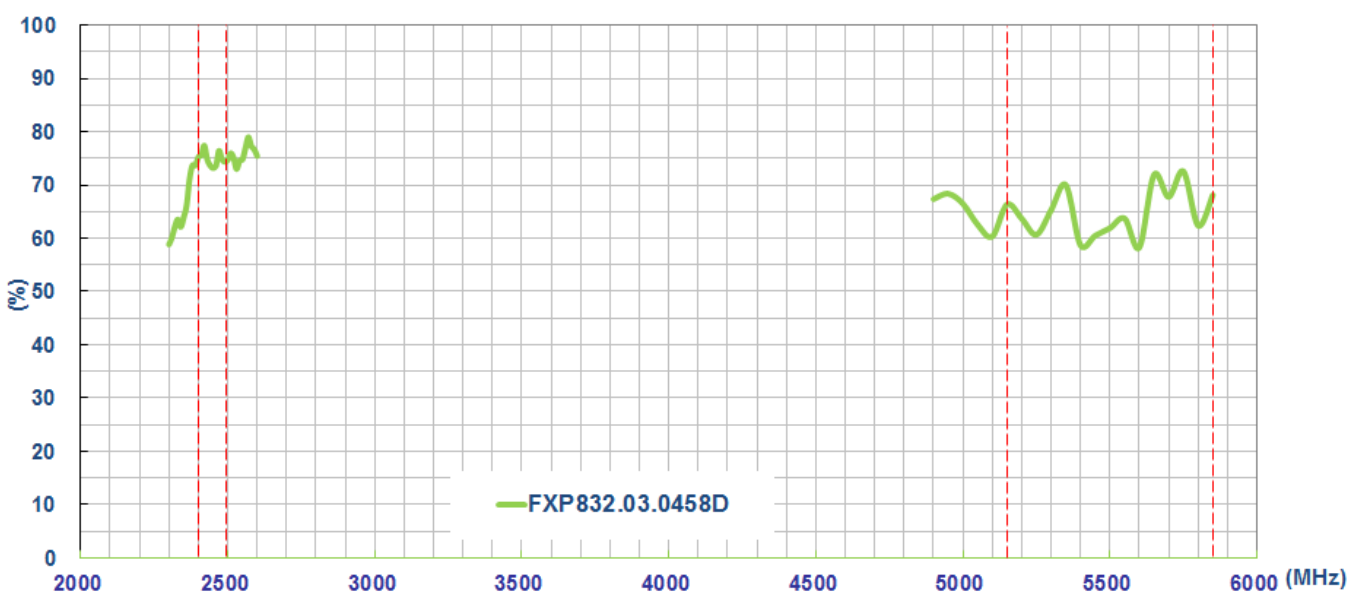

3.3 Peak Gain

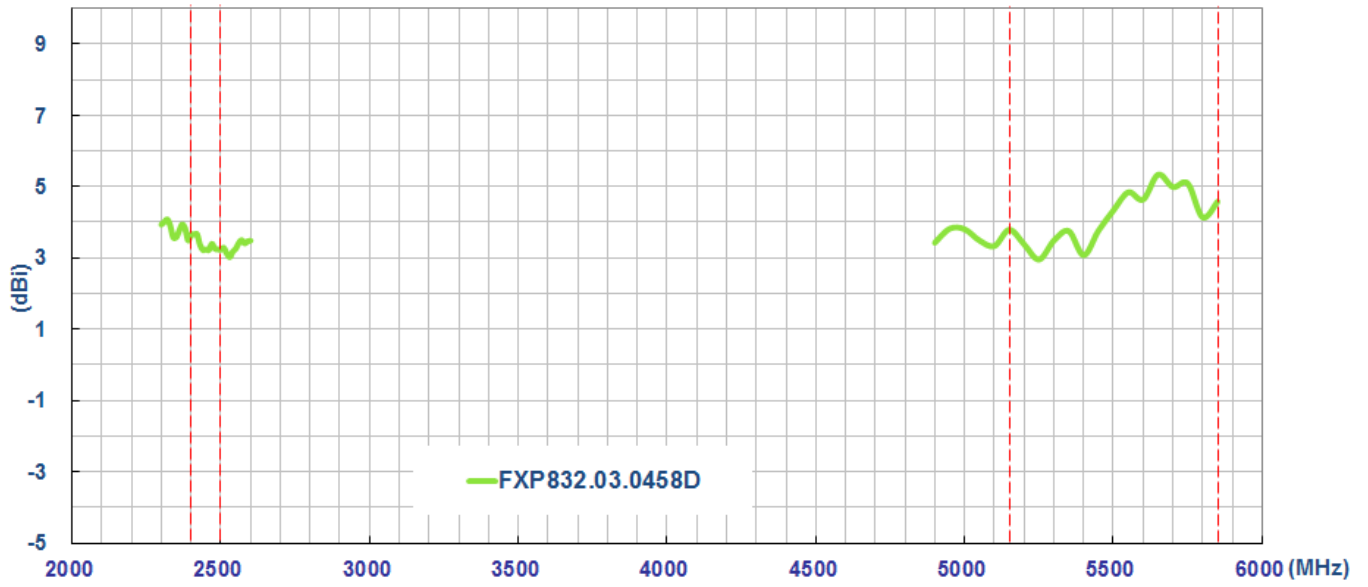

4. 2D Radiation Patterns

4.1 Test Setup

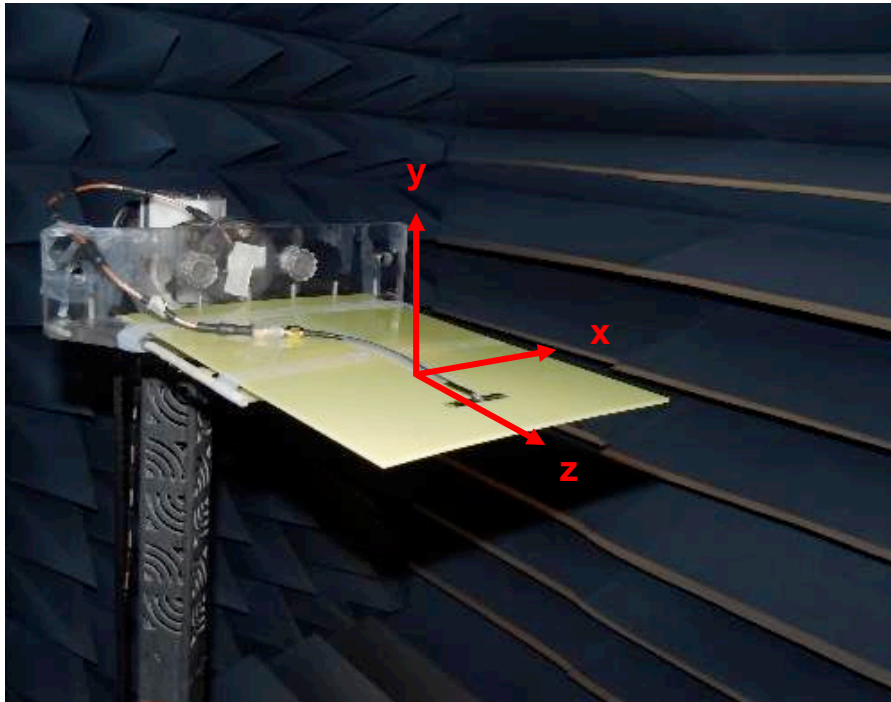

Free space

XY Plane

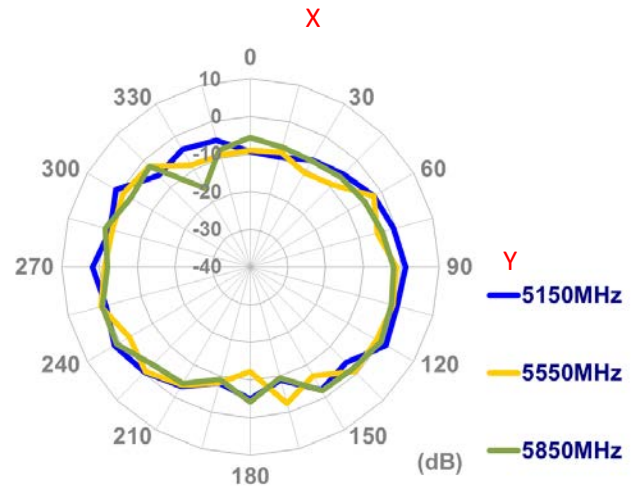
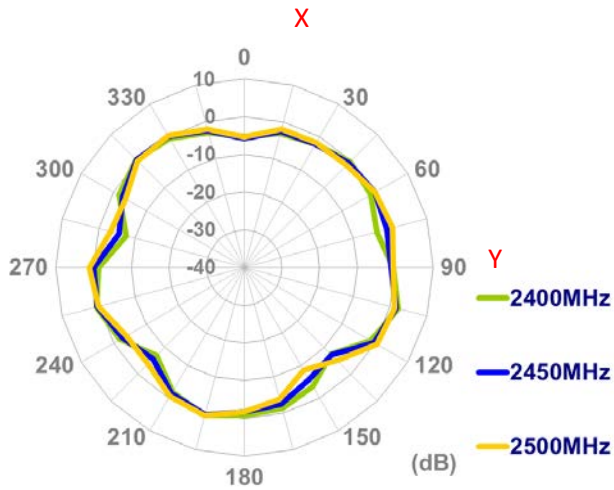

XZ Plane

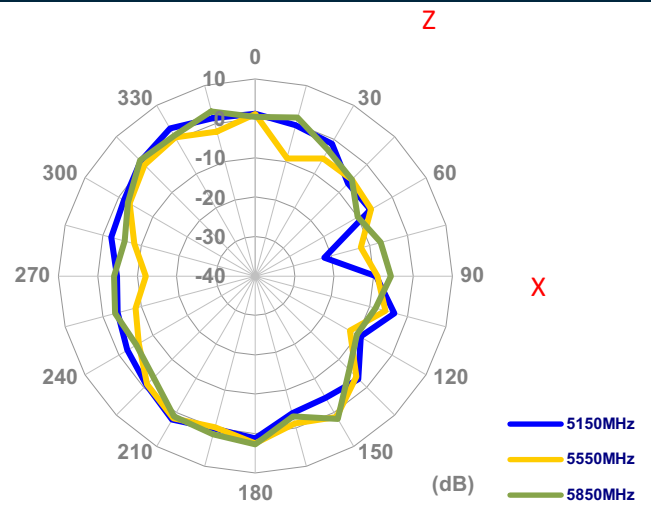
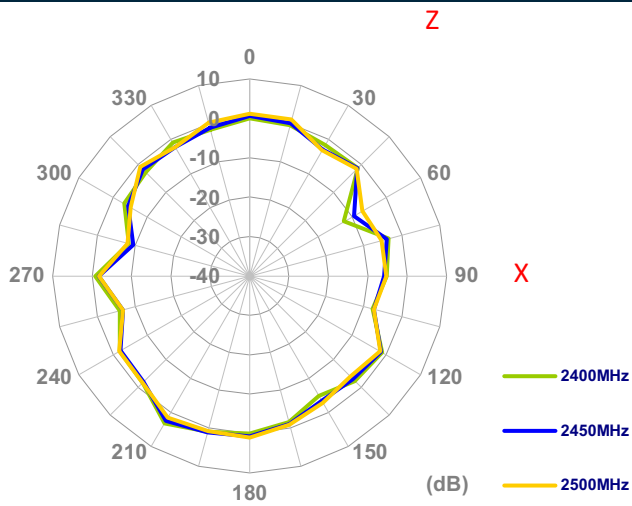

YZ Plane

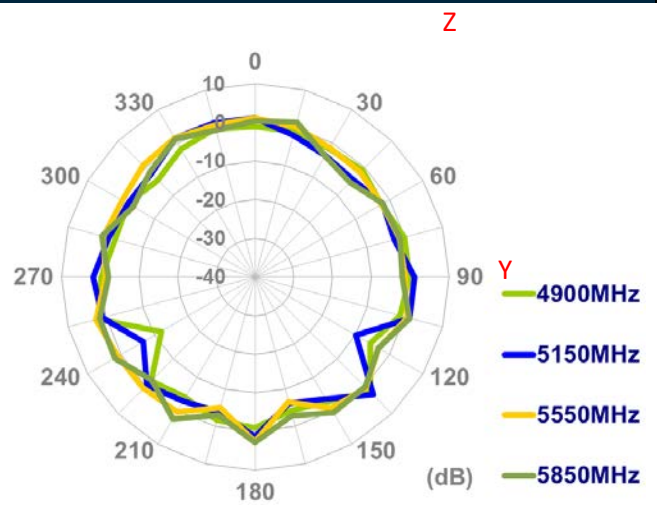
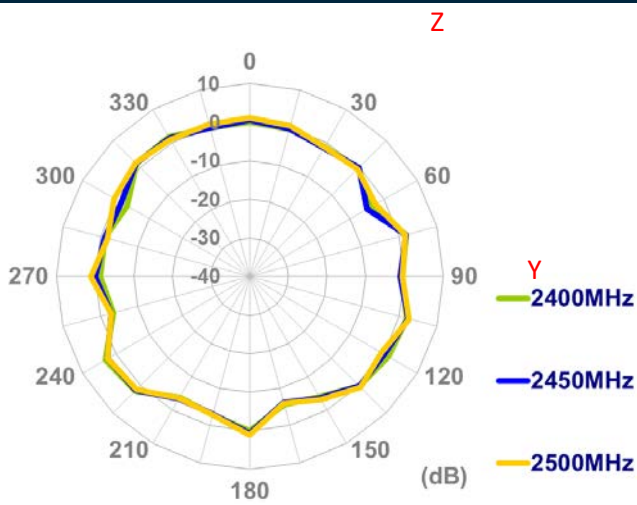

5. 3D Radiation Patterns

5.1 Free Space

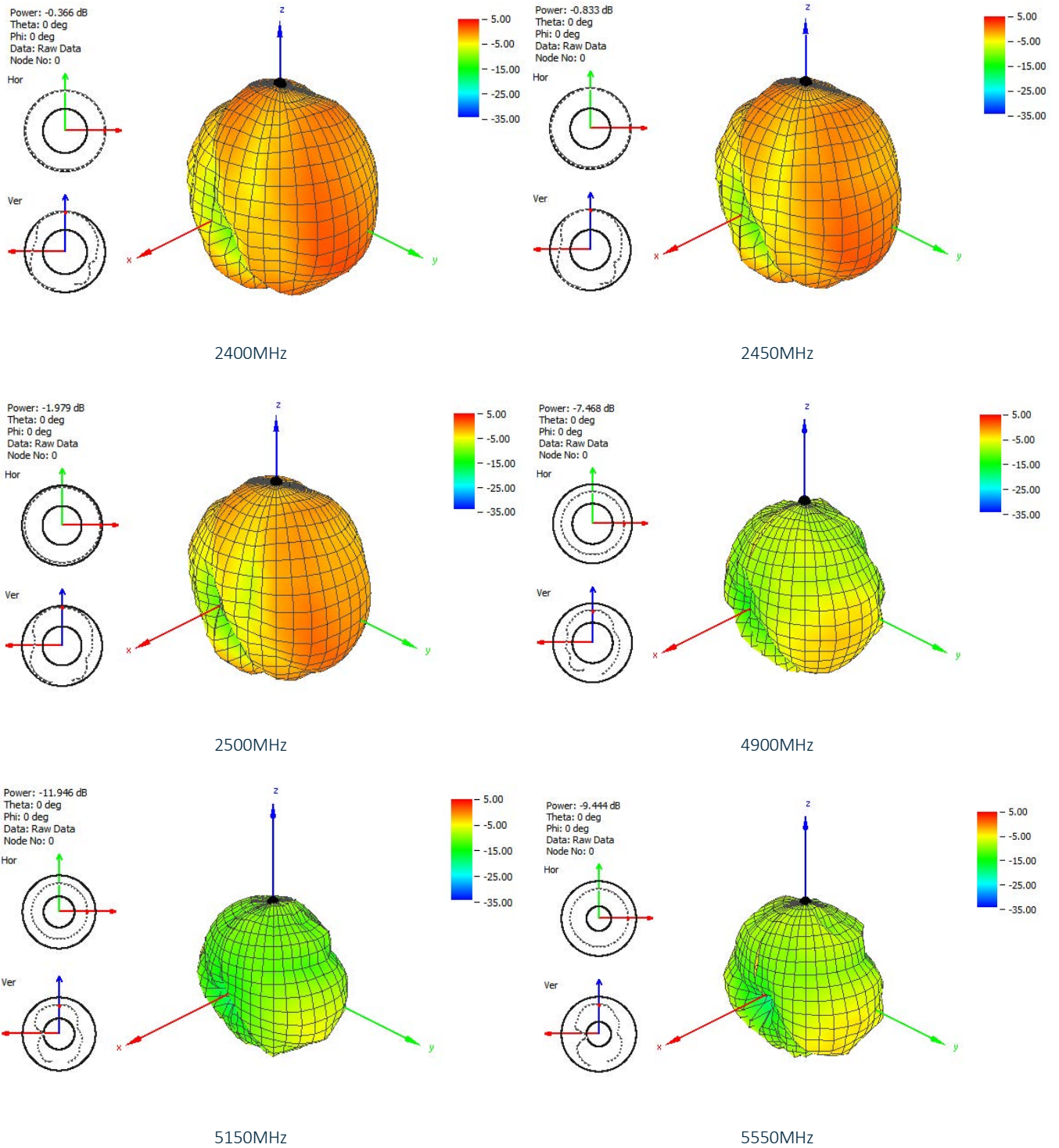

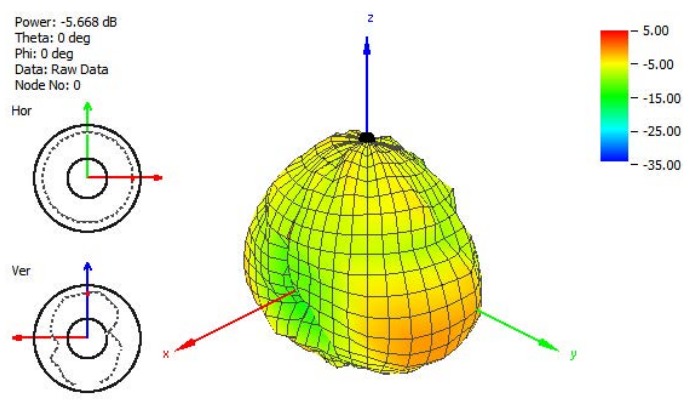

5850MHz

6. Mechanical Drawing (Units: mm)

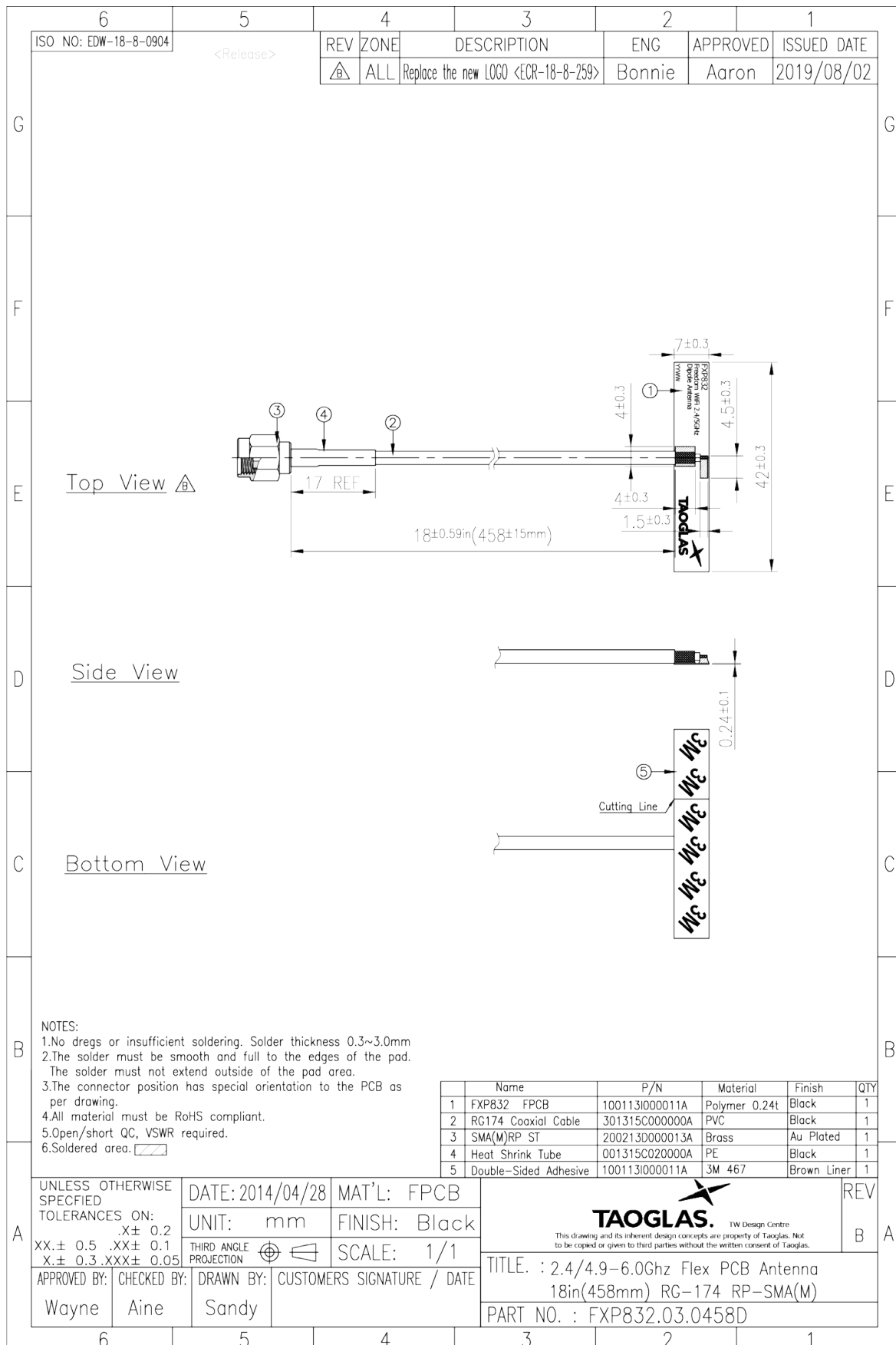

7. Packaging

50pcs FXP832.03.0458D per PE Bag
 Bag Dimensions: 450*280mm
 Weight: 375g

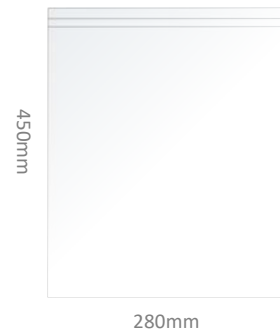

500pcs FXP832.03.0458D per carton
 Dimensions: 320*250*230mm
 Weight: 3.75Kg

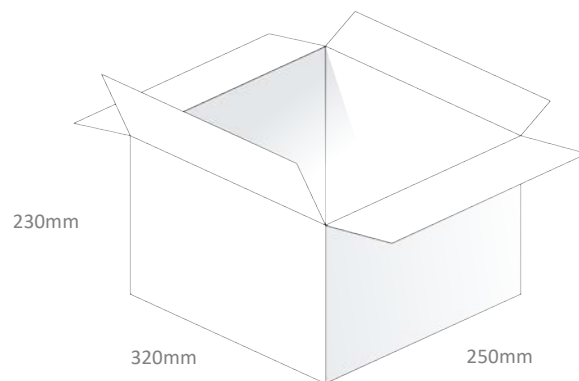

Changelog for the datasheet

SPE-17-8-042 – FXP832.03.0458D

Revision: E (Current Version)

Date:	2019-11-14
Changes:	Updated Images
Changes Made by:	Russell Meyler

Previous Revisions

Revision: D

Date:	2019-07-23
Changes:	Packaging Amended
Changes Made by:	Jack Conroy

Revision: C

Date:	2015-06-30
Changes:	Added DSRC
Changes Made by:	Aine Doyle

Revision: B

Date:	2015-01-20
Changes:	added note on gain and 3D radiation patterns
Changes Made by:	Aine Doyle

Revision: A (Original First Release)

Date:	2014-04-07
Notes:	
Author:	Aine Doyle