



TAOGLAS®



Datasheet

Part No:
FXR.3030 Series

Description:

Square Form Factor Flexible Near Field Communications Antenna

Features:

13.56 MHz Antenna

Flexible Low Profile Embedded

Reading distance: Typical interrogation distance: 40 mm

Dimensions:

- Length and Height: 30 x 30 mm
- Thickness: 0.14 mm - FXR.3030.A - NFC without ferrite
- Thickness: 0.27 mm - FXR.3030.A.dg - NFC with ferrite
- Thickness: 0.27 mm - FXR.3030.52.0075X.A.dg - NFC with ferrite and 75mm twisted cable.

Peel and stick 3M adhesive on back

RoHS & Reach Compliant

1. Introduction	3
2. Specifications	4
3. Antenna Application	5
4. Mechanical Drawing	10
5. Packaging	13
<hr/>	
Changelog	14

Taoglas makes no warranties based on the accuracy or completeness of the contents of this document and reserves the right to make changes to specifications and product descriptions at any time without notice. Taoglas reserves all rights to this document and the information contained herein. Reproduction, use or disclosure to third parties without express permission is strictly prohibited.



1. Introduction



The Taoglas FXR and FXC series of high-performance NFC (Near Field Communications) antennas are ideal for IoT and mobile devices and for applications such as contactless payment systems, access control or RFID systems.

The compact, flexible NFC antennas are supplied with adhesive backing for quick and easy installation and can be mounted inside a plastic device enclosure or on an internal battery. For any NFC antennas that are attached to the battery, we offer variants with ferrite flux directors to provide isolation from the battery or other electronic components within the device. Using the antenna on a conductive surface without a ferrite layer could result in losses on the antenna communication performance.

Taking into consideration the many environments that the antenna could be used, Taoglas offers three versions of each of the FXR and FXC series models. A standard model without ferrite and adhesive backing, a model with a ferrite layer and adhesive backing and a third model with ferrite and a 75mm Twisted Pair 28AWG cable with ACH(F) connectors.

Typical Applications Include:

- Mobile Devices
- Wearable Smart Devices
- Payment Terminals
- Device tracking and ID systems
- Access control

For further optimization to customer-specific device environments and for support to integrate and test this antennas performance in your device, contact your regional Taoglas Customer Services Team.

2. Specifications

Electrical			
Part Number	FXR. 3030.A	FXR.3030.A.dg	FXR.3030.52.0075X.A.dg
Frequency	13.56 MHz	13.56 MHz	13.56 MHz
La	0.75 μ H	1.06 μ H	1.15 μ H
Rs	1.09 ohm	1.82 ohm	1.97 ohm
Q Factor	58.6	49.6	49.7
Self-Resonance Frequency	136 MHz	109.5 MHz	71.1 MHz
Rp	10.4 kohm	3.85 kohm	3.78 kohm
Mechanical			
Antenna Dimensions	30*30 mm	30*30 mm	30*30 mm
Thickness	0.14 mm	0.27 mm	0.27 mm
RoHS Compliant	Yes	Yes	Yes
Adhesive	3M467 or 3M9460	3M467 or 3M9460	3M467 or 3M9460
Weight	1 g	1 g	1 g
Environmental			
Operation Temperature	-40°C to 85°C	-40°C to 85°C	-40°C to 85°C
Storage Temperature	-40°C to 85°C	-40°C to 85°C	-40°C to 85°C
Humidity	Non-condensing 65°C 95% RH	Non-condensing 65°C 95% RH	Non-condensing 65°C 95% RH

* Contact pads are gold plated copper. Base material is polyimide which can take heat from soldering for brief periods suitable for attaching wires. Additional wire length will affect read range and result in different performance than that detailed in this document.

3. Antenna Application

3.1 Test Setup

A test fixture is used to measure the maximum interrogation distance. The FXR.3030.A antenna is connected to NFC evaluation boards and then placed under the PC material blocks to communicate with the standard card above them.

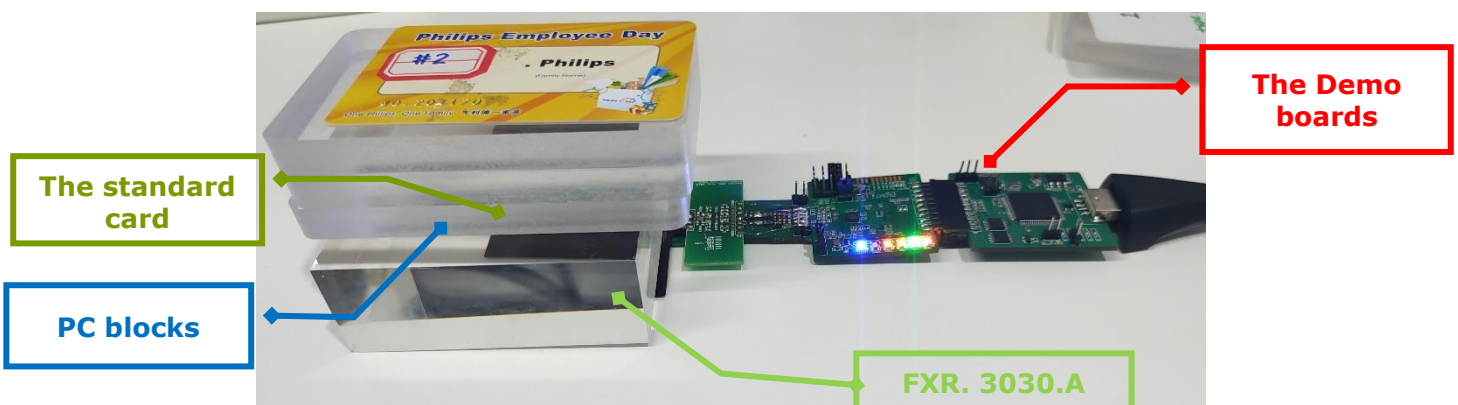

When the number of the PC material blocks are carefully adjusted until the reader can no longer read the sample, that's mean in this point the FXR.3030.A cannot establish communication with the standard card or the POS machine, the thickness of the PC material block is the maximum interrogation distance of them.

3.2 RFID Tags and POS Used for Test

A total of 5 NFC forum tags were used to measure the interrogation distances. The next picture shows type 1, type 2, type 3, type 4 and type 5 tags, respectively.



Type 1 is based on ISO/IEC 14443A standard and has 96 bytes of memory.

Type 2 is based on ISO/IEC 14443A standard and has 144 bytes of memory.

Type 3 is based on ISO-18092, JIS-X-6319-4 Sony Felica standard and has 9k bytes of memory.

Type 4 is based on ISO / IEC 14443A 1-4 compliant and has 4K of memory

Type 5 is based on ISO-15693 specification, the communication with this NFC Forum Tag type is based on NFC-V Technology.

3.3 The POS machine used for test

The next picture shows the POS machine using to measure the Card emulation performance of the FXR.4040. Series NFC antennas.



ACR122 is a PC-linked contactless smart card reader/writer developed on the 13.56MHz Contactless (RFID) Technology and followed the ISO/IEC18092 Standard for Near Field Communication (NFC), supporting not only MIFACE® ISO 14443 A and B cards but also NFC and FELICA contactless technologies.

The ACR122 is a USB Plug and Play device with CCID compliance. By making use of up to 424 Kbps for NFC Tag access and full USB speed of up to 12 Mbps, the ACR122 can read and write faster and more efficiently. The proximity operating distance of ACR122 is up to 5 cm, depending on the type of contactless tag in use. Operating distance can be extended on request by adding an RF booster, so the ACR122 is suitable for logistics and supply chain management.

T6-BU-00-00 is a 13.56MHz high frequency readable and writable device, a USB drive-free RFID reader card which supports ISO14443 standard protocol Class A card reading and writing read and write. Also, T6-BU-00-00 is a module that can be set to read and write a chip card that supports the ISO15693 standard protocol.

3.3 Matching

The interrogation distances presented here were taken with the antenna connected directly to the evaluation boards with the optimized matching circuit. For the NXP PN553 chipset, it is suggested using 20ohm impedance of the NFC antenna. Just like below:

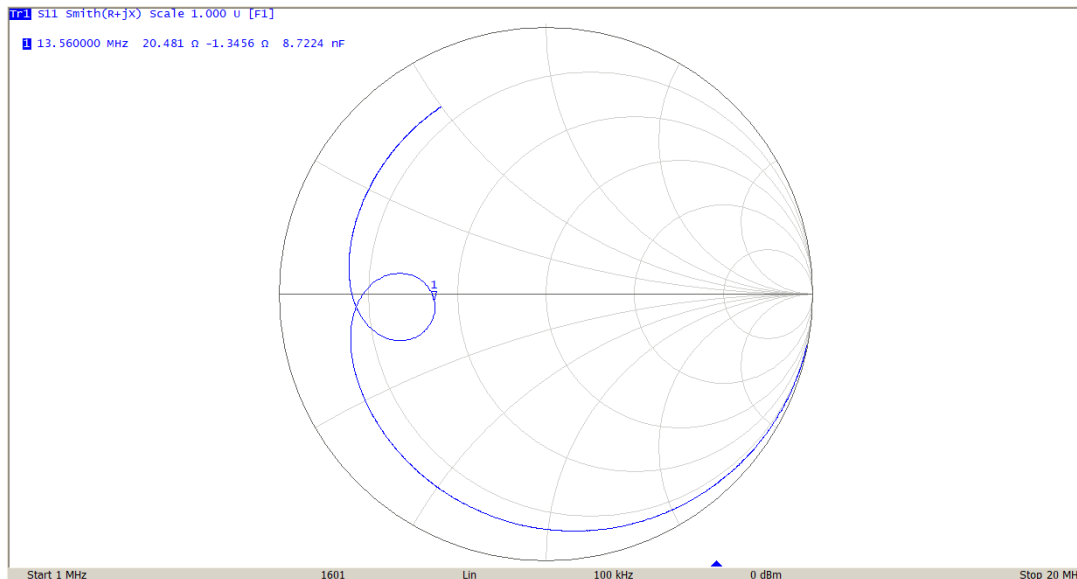

As with any matching network the exact circuit and values for an optimal network depend on the combination of antenna, NFC circuit, any intervening transmission line and the environment presented to the antenna. These factors are specific to the particular end product.

As a starting point, to achieve the read range results presented here, use the matching network detailed in the schematic of the evaluation board for your particular NFC chip and keep the antenna free of any obstruction. Once you can demonstrate successful reads you can then optimize performance as desired.

3.4 Read/Write & Card emulation mode

The NFC forum card type 1~5 were used to measure the interrogation distances in Read/write mode. The POS machine ACR122, T6-14443 T6-15693 were used to measure the interrogation distances in Card emulation mode. The results are in the next tables:

Device	Interrogation Distance(mm)		
	FXR.3030.A	FXR.3030.A.dg	FXR.3030.52.0075X.A.dg
Topaz512 (Type 1)	57	40	37
NTAG203 (Type 2)	59	39	38
Sony Felica (Type 3)	39	27	27
Mifare DESFire (Type 4)	36	20	19
ISO 15693 (Type 5)	105	70	68
ACR122	105	64	58
T6-14443	78	46	40
T6-15693	106	65	57

4. Mechanical Drawing (Units: mm)

4.1 FXR.3030.A

- NOTES: 1. This drawing is strictly confidential.
 2. All related parts and material must be RoHS compliant.
 3. " * " Critical Dimensions.

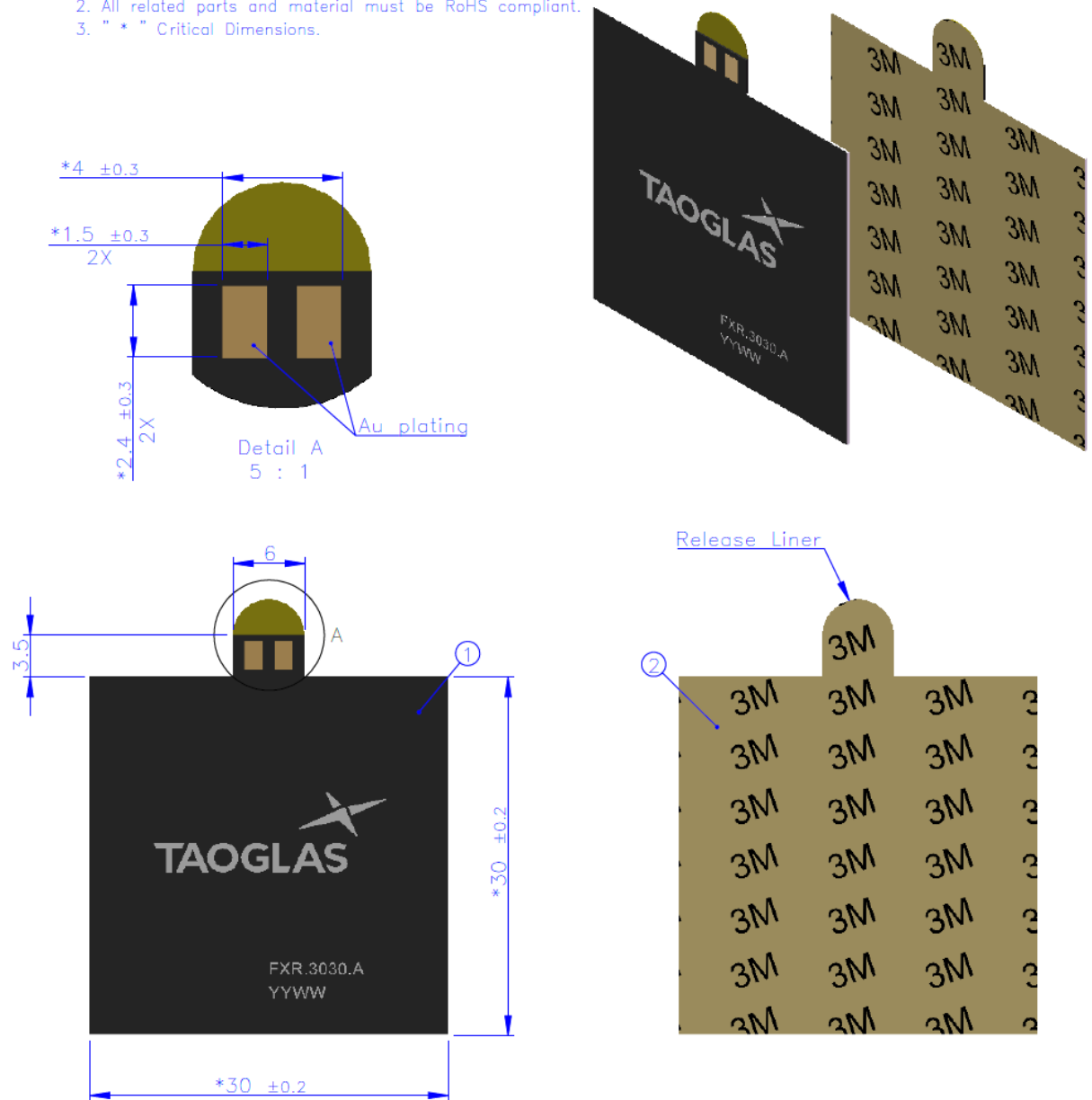

	Name	Material	Finish	QTY	Thickness(um)
1	FPC	ED copper/PI Base/ED Copper	Ni/Au Plating	1	110
2	Adhesive	3M Adhesive	Natural	1	50
Total Thickness (Not including liner)					160 ±30

4.2 FXR.3030.A.dg

- NOTES: 1. This drawing is strictly confidential.
 2. All related parts and material must be RoHS compliant.
 3. " * " Critical Dimensions.

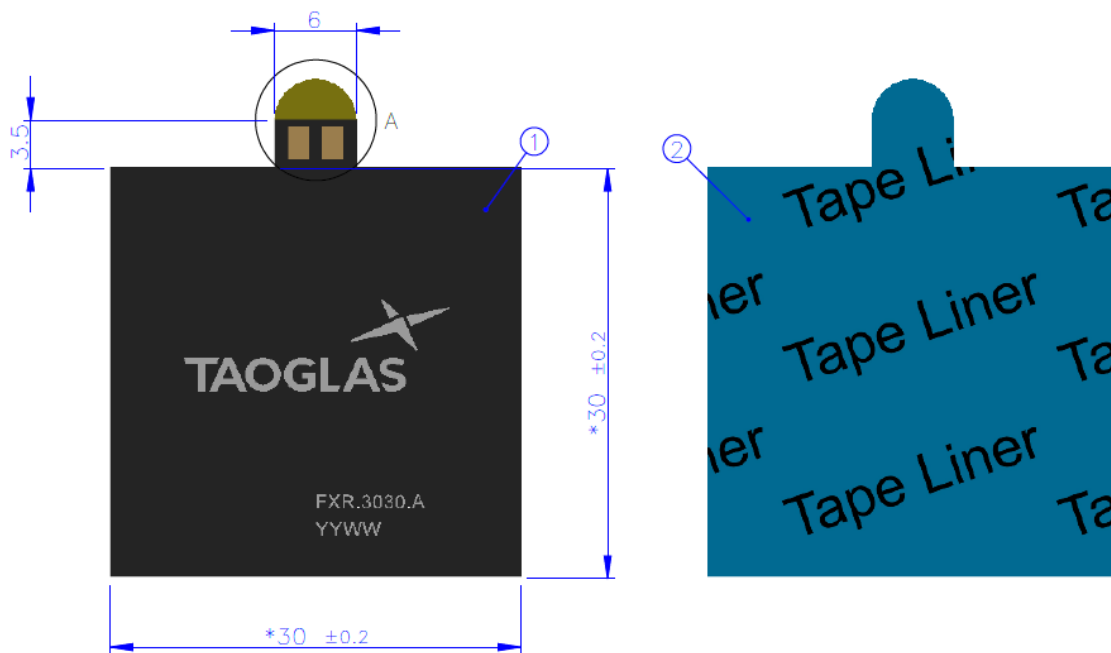
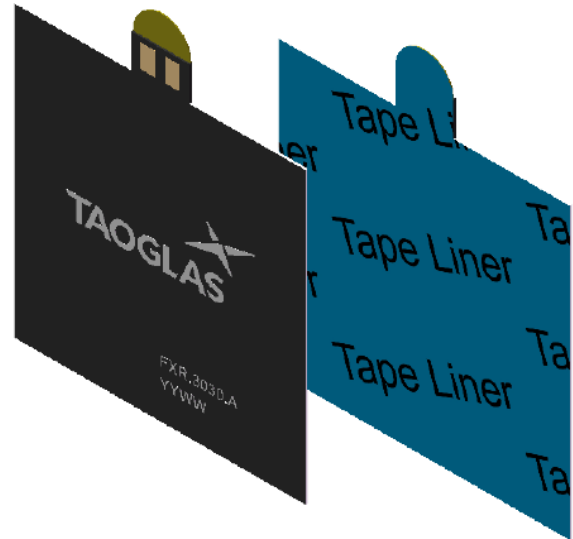
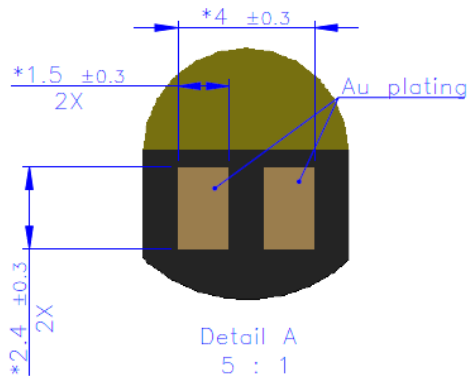

	Name	Material	Finish	QTY	Thickness(um)
1	FPC with adhesive	ED copper/PI Base/ED Copper/Adhesive	Ni/Au Plating	1	160
2	Ferrite with adhesive	Cover Film/Ferrite/Adhesive/Tape Liner	Natural	1	140
Total Thickness (Not including liner)					300 ± 50

4.3 FXR.3030.52.0075X.A.dg

- NOTES: 1. This drawing is strictly confidential.
 2. All related parts and material must be RoHS compliant.
 3. " * " Critical Dimensions

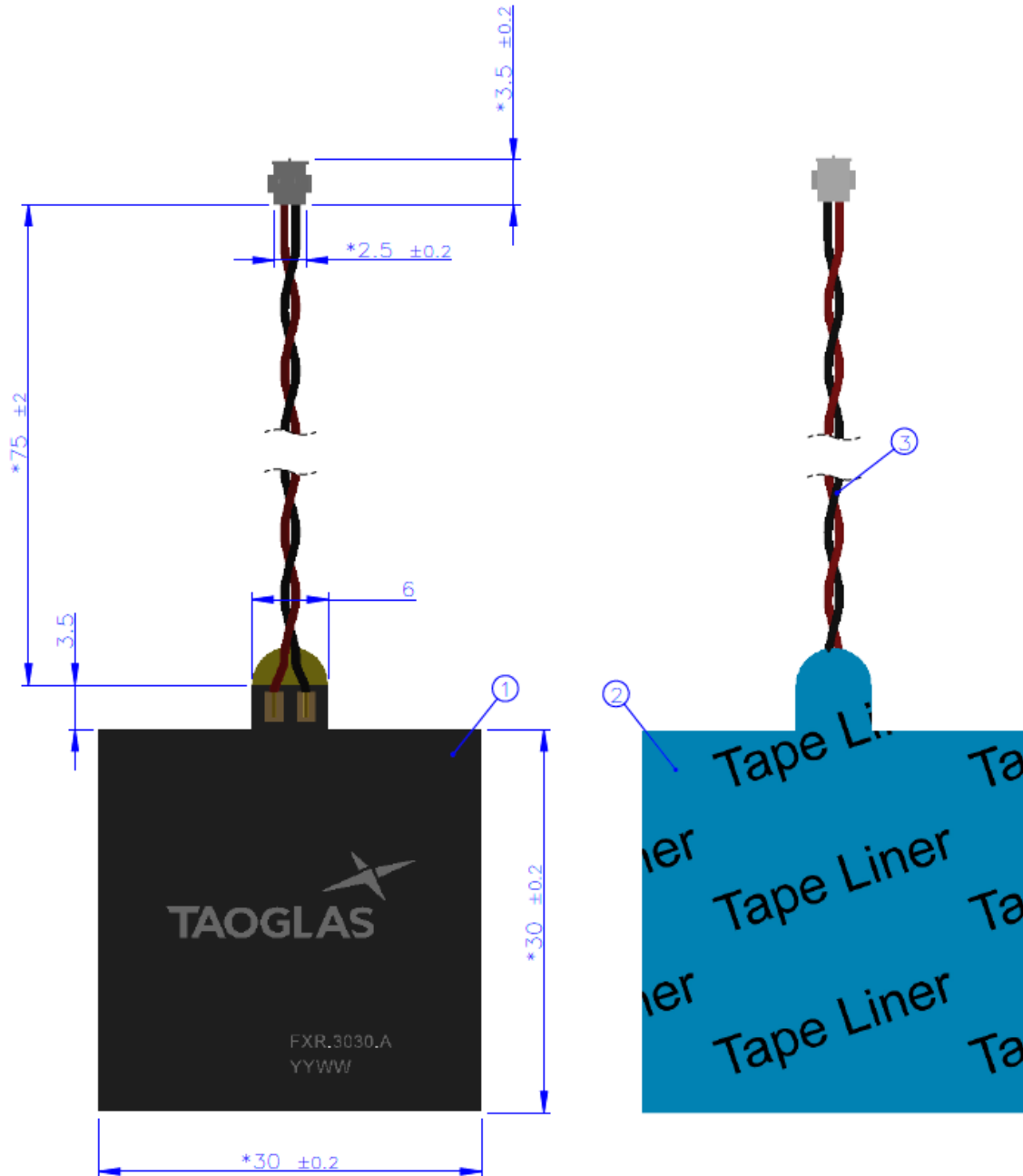

	Name	Material	Finish	QTY
1	FPC with Adhesive	ED copper/PI Base /ED Copper/Adhesive	Ni/Au plating	1
2	Ferrite with Adhesive	Cover Film/Ferrite /Adhesive	Black	1
3	Twisted Pair 28AWG cable and ACH(F)	PVDF	Red &Black	1

5. Packaging

FXR.3030 Series
1 pcs / Small PE Bag



100pcs/ Grid of Honeycomb Board

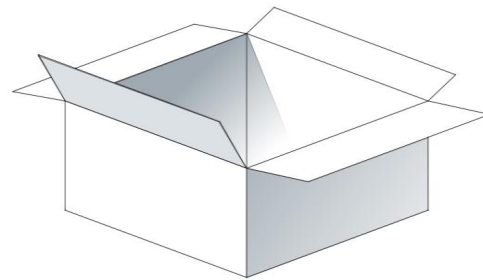

Honeycomb Board 1 set
Carton(mm): 230(L)x175(W)x160(H)
Carton board 2 pcs
Carton Label

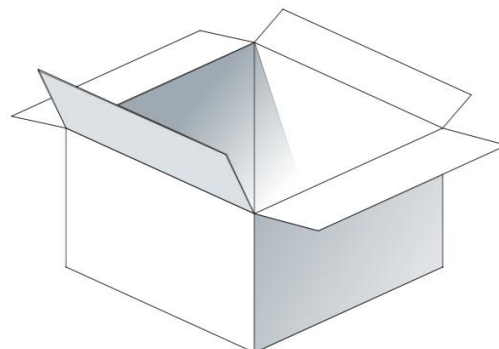

Changelog for the datasheet

SPE-22-8-122 – FXR.3030 Series

Revision: A (Original First Release)	
Date:	2022-09-01
Notes:	
Author:	Cesar Sousa

Previous Revisions
