



Datasheet

FXUB62.07.0150C

Patent Pending

Description:

LTE Wide Band Flex Antenna
698MHz -3000 MHz

Features:

Patent Pending
Ground Plane Independent
Operates at 4G Bands from 698-3000MHz
>45% Efficiency on All covered bands
5dBi Peak Gain
I-PEX MHF® I (U.FL comp)
150mm Ø1.37 coaxial cable
Dimensions: 96*21*0.2 mm
RoHS & Reach Compliant

1. Introduction	3
2. Specifications	4
3. Antenna Characteristics	6
4. Radiation Patterns	8
5. Mechanical Drawing	16
6. Packaging	17
<hr/>	
Changelog	18

Taoglas makes no warranties based on the accuracy or completeness of the contents of this document and reserves the right to make changes to specifications and product descriptions at any time without notice. Taoglas reserves all rights to this document and the information contained herein.

Reproduction, use or disclosure to third parties without express permission is strictly prohibited.

© Taoglas



1. Introduction

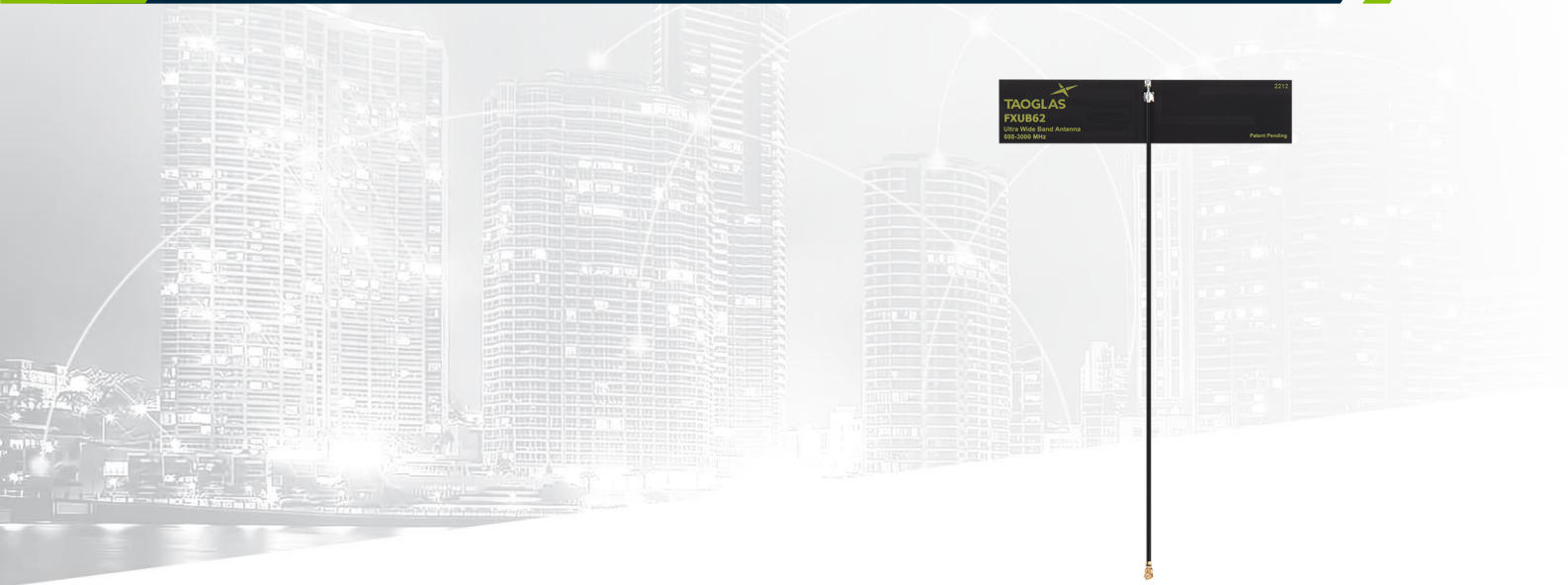

The patent pending FXUB62 flexible wideband antenna has been designed to cover all working frequencies in the 698-3000MHz spectrum, covering all Cellular, 2.4GHz Wi-Fi, ISM and AGPS. The antenna is delivered with a flexible body with excellent efficiencies on all bands, ground independent, with cable and connector for easy installation.

The FXUB62 flexible polymer antenna, at 96*21*0.2mm, is ultra thin and wideband with high efficiencies across the bands. It is assembled by a simple “peel and stick” process, attaching securely to non-metal surfaces via 3M adhesive. It enables designers to use only one antenna that covers all common LTE frequencies.

Typical Applications Include:

- Wearable Healthcare Devices
- Point of Sale Terminals
- Handheld Devices

The FXUB62 antenna is a durable flexible polymer antenna that has a peak gain of 5dBi, an efficiency of more than 45% across the bands and is designed to be mounted directly onto a plastic or glass cover. It is an ideal choice for any device maker that needs to keep manufacturing costs down over the lifetime of a product. It is ground plane independent and delivered with a cable and connector for easy connecting to the wireless module or customer PCB.

Cables and Connectors are fully customizable. Like all such antennas, care should be taken to mount the antenna at least 10mm from metal components or surfaces, and ideally 20mm for best radiation efficiency. For further information, please contact your regional Taoglas customer support team.

2. Specifications

5G/4G Bands			
Band Number	5G NR / FR1 / LTE / LTE-Advanced / WCDMA / HSPA / HSPA+ / TD-SCDMA		
	Uplink	Downlink	Covered
1	UL: 1920 to 1980	DL: 2110 to 2170	✓
2	UL: 1850 to 1910	DL: 1930 to 1990	✓
3	UL: 1710 to 1785	DL: 1805 to 1880	✓
4	UL: 1710 to 1755	DL: 2110 to 2155	✓
5	UL: 824 to 849	DL: 869 to 894	✓
7	UL: 2500 to 2570	DL: 2620 to 2690	✓
8	UL: 880 to 915	DL: 925 to 960	✓
9	UL: 1749.9 to 1784.9	DL: 1844.9 to 1879.9	✓
11	UL: 1427.9 to 1447.9	DL: 1475.9 to 1495.9	✗
12	UL: 699 to 716	DL: 729 to 746	✓
13	UL: 777 to 787	DL: 746 to 756	✓
14	UL: 788 to 798	DL: 758 to 768	✓
17	UL: 704 to 716	DL: 734 to 746	✓
18	UL: 815 to 830	DL: 860 to 875	✓
19	UL: 830 to 845	DL: 875 to 890	✓
20	UL: 832 to 862	DL: 791 to 821	✓
21	UL: 1447.9 to 1462.9	DL: 1495.9 to 1510.9	✗
22	UL: 3410 to 3490	DL: 3510 to 3590	✗
23	UL: 2000 to 2020	DL: 2180 to 2200	✓
24	UL: 1625.5 to 1660.5	DL: 1525 to 1559	✓
25	UL: 1850 to 1915	DL: 1930 to 1995	✓
26	UL: 814 to 849	DL: 859 to 894	✓
27	UL: 807 to 824	DL: 852 to 869	✓
28	UL: 703 to 748	DL: 758 to 803	✓
29	UL: -	DL: 717 to 728	✓
30	UL: 2305 to 2315	DL: 2350 to 2360	✓
31	UL: 452.5 to 457.5	DL: 462.5 to 467.5	✗
32	UL: -	DL: 1452 - 1496	✗
35		1850 to 1910	✓
38		2570 to 2620	✓
39		1880 to 1920	✓
40		2300 to 2400	✓
41		2496 to 2690	✓
42		3400 to 3600	✗
43		3600 to 3800	✗
48		3550 to 3700	✗
66	UL: 1710-1780	DL: 2110-2200	✓
71		617 to 698	✓
74/75/76		1427 to 1518	✓
78		3300 to 3800	✗
79		4400 to 5000	✗
85	698-716	728-746	✓

Electrical						
Frequency (MHz)	698-960	1575.42	1710 -1990	1755-2170	2400 -2500	2500-2690
Efficiency (%)						
On 3mm ABS	61	77	70	70	64	55
Average Gain (dB)						
On 3mm ABS	-2.1	-1.1	-1.5	-1.6	-1.9	-2.6
Peak Gain (dBi)						
On 3mm ABS	2.4	4.5	5.9	5.9	4.6	4.0
Max VSWR						
On 3mm ABS	5.2	2.0	1.9	2.0	1.8	1.8
Max Return Loss (dB)						
On 3mm ABS	-3.4	-9.7	-10.5	-9.8	-10.7	-10.7
Impedance	50Ω					
Polarization	Linear					
Radiation Pattern	Omni					
Input Power	5W Max					
Mechanical						
Dimensions (mm)	96*21*0.2 mm					
Material	Flexible Polymer					
Connector	I-PEX MHFI (U.FL Compatible)					
Cable Length	150 mm					
Cable Type	1.37 mm mini coax					
Environmental						
Operation Temperature	-40°C to 85°C					
Storage Temperature	-40°C to 85°C					
Relative Humidity	40% to 95%					

3. Antenna Characteristics

3.1 Return Loss

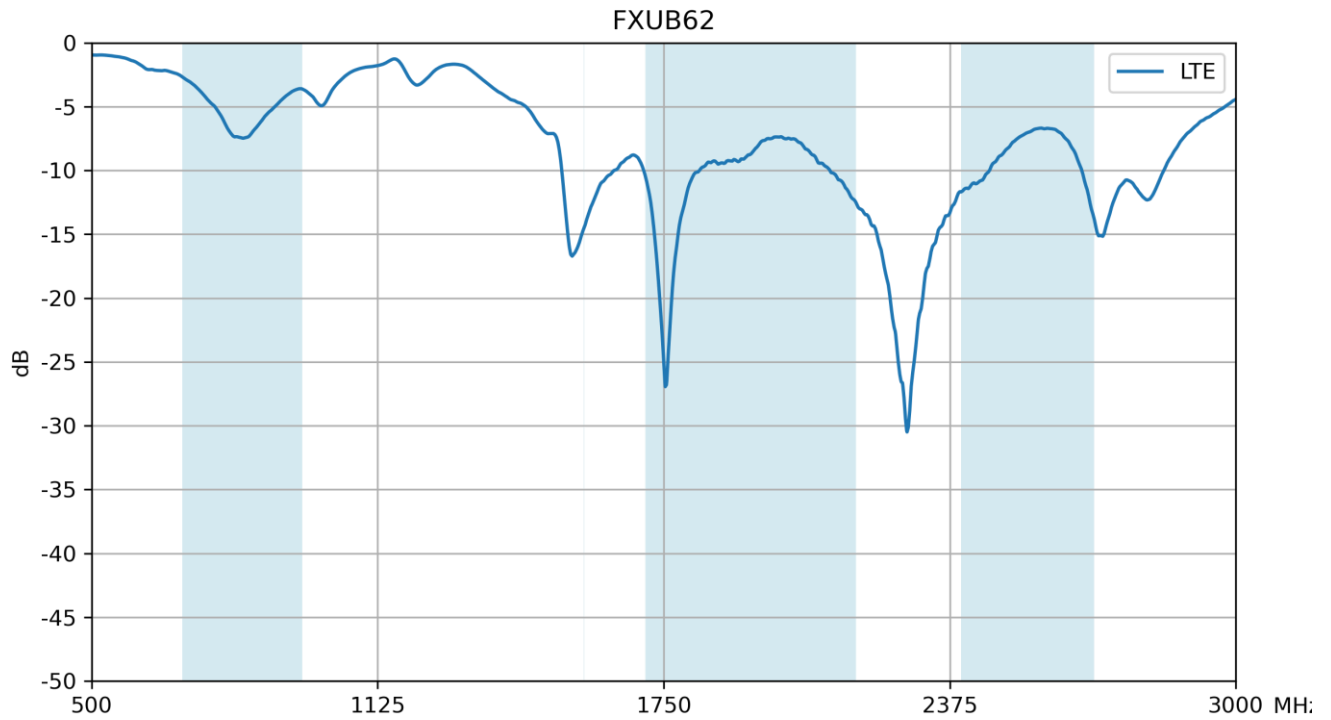

3.2 Efficiency

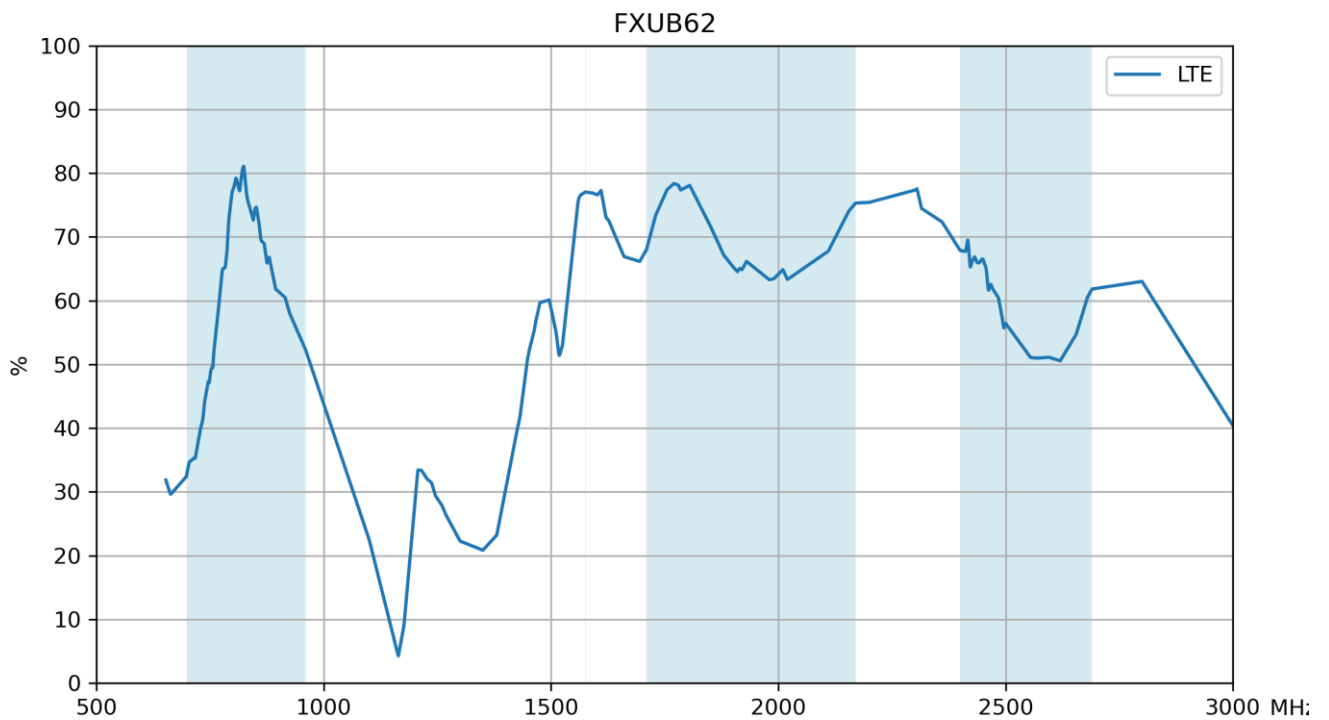

3.3 Peak Gain

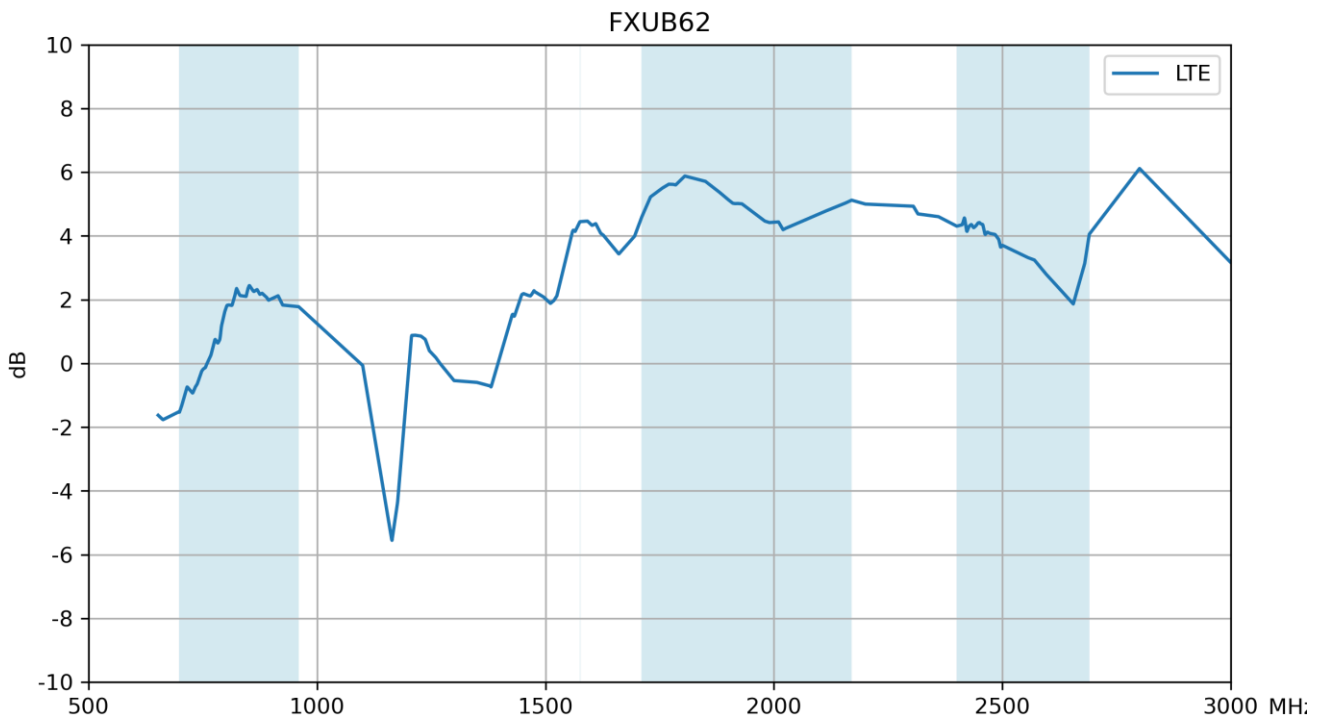

3.4 Average Gain

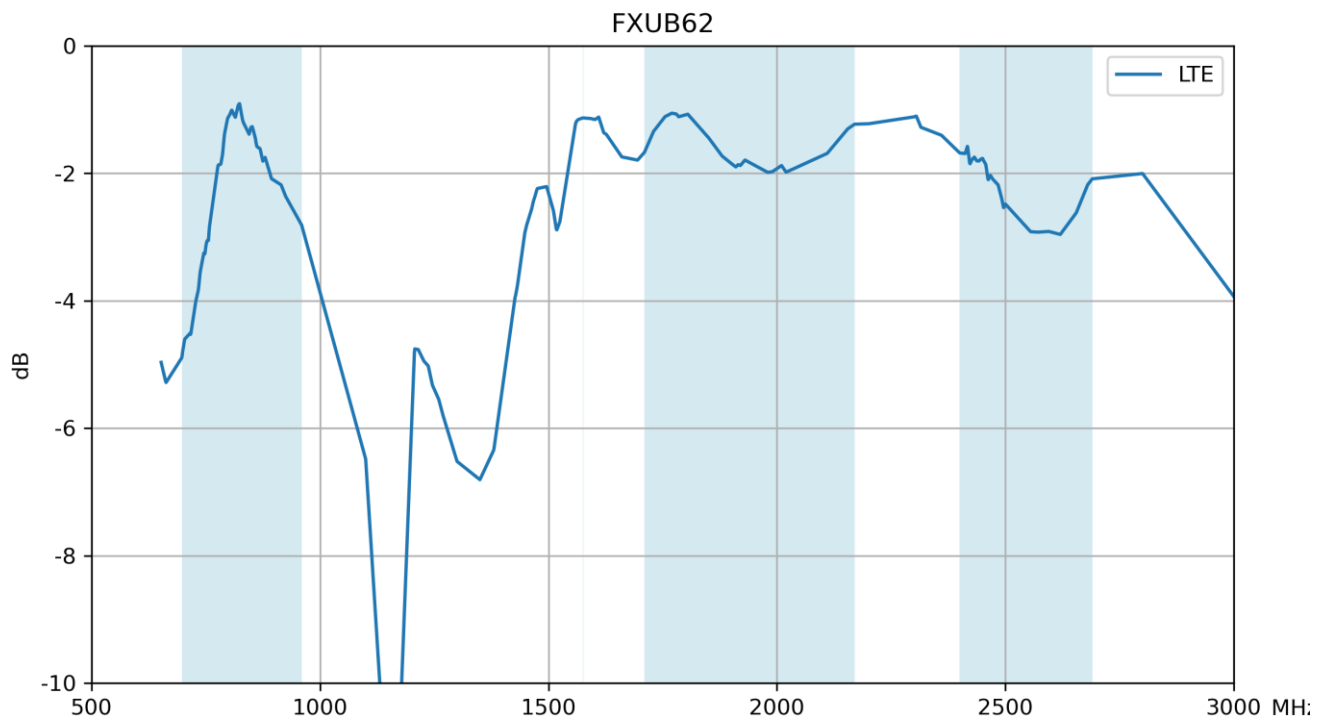

4. Radiation Patterns

4.1 Test Setup

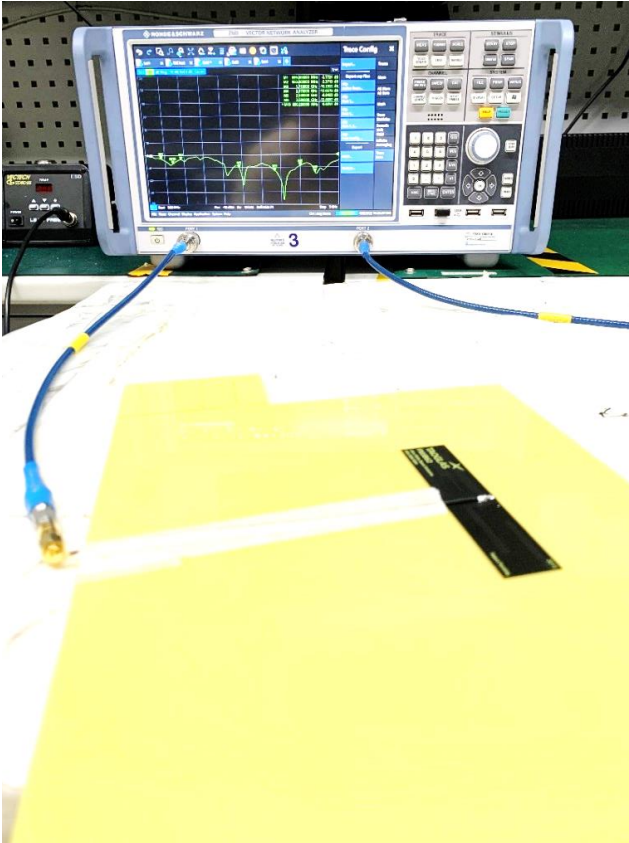

VNA Set-Up

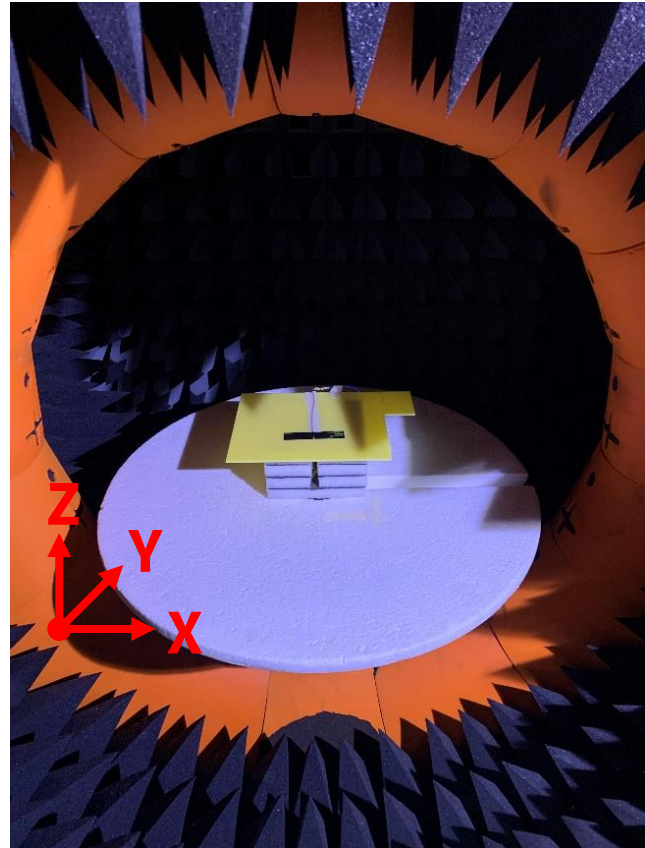

Chamber Set-Up

751MHz

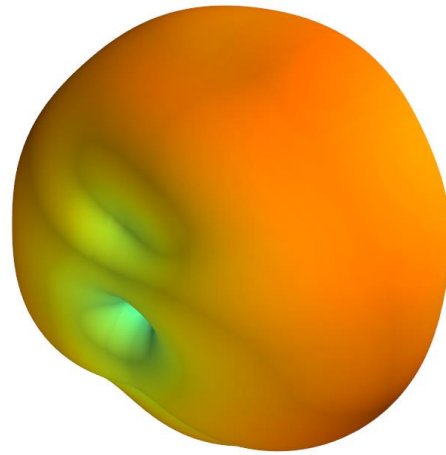

XY Plane

XZ Plane

YZ Plane

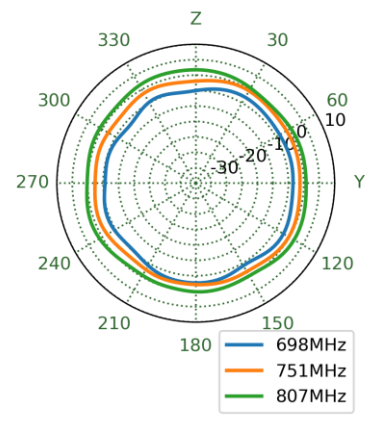
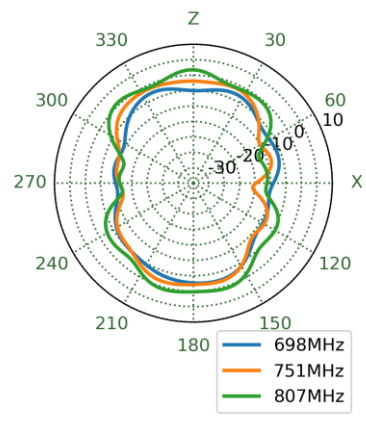
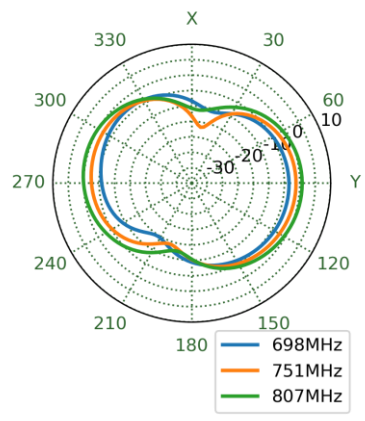

890MHz

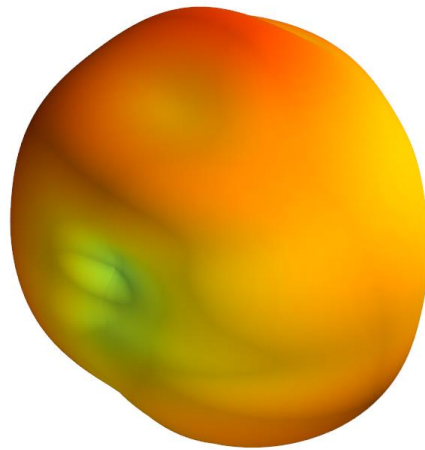

XY Plane

XZ Plane

YZ Plane

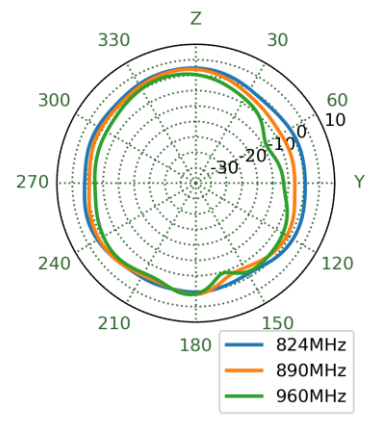
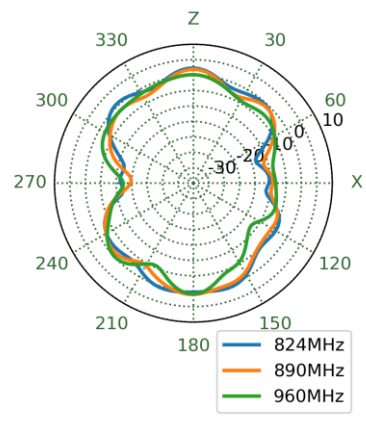
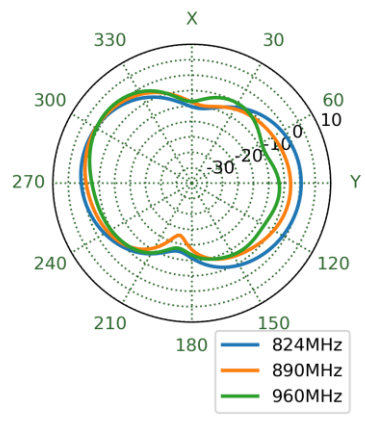

1575MHz

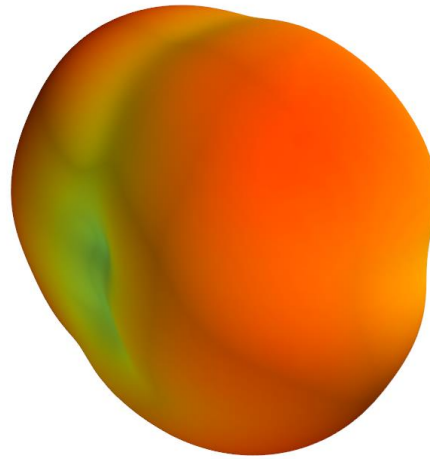

XY Plane

XZ Plane

YZ Plane

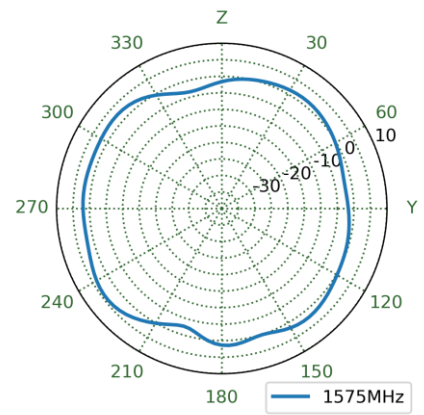
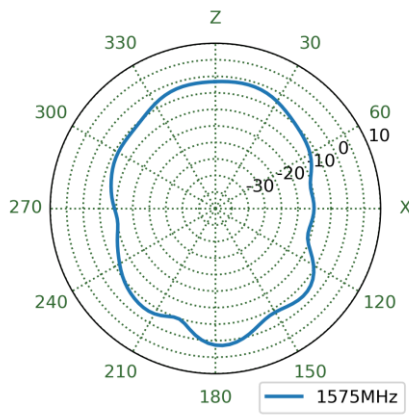
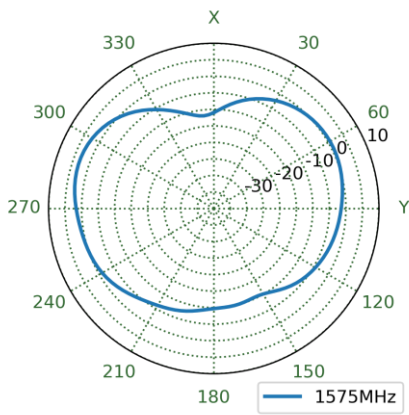

1805MHz

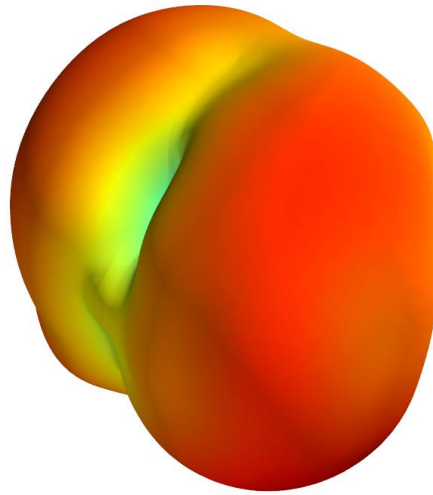

XY Plane

XZ Plane

YZ Plane

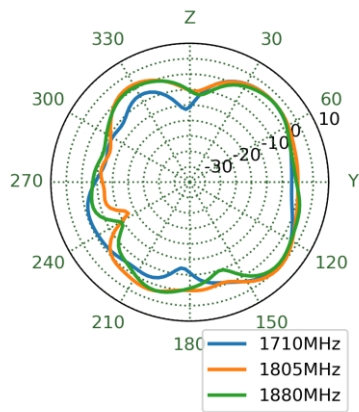
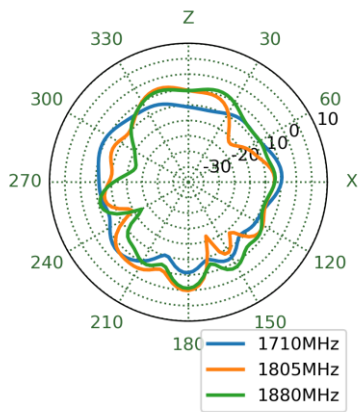
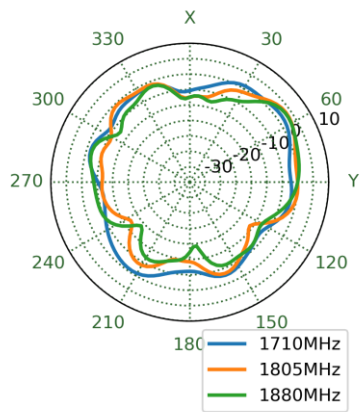

1920MHz

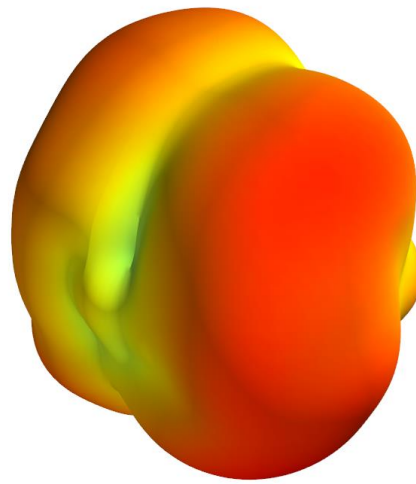

XY Plane

XZ Plane

YZ Plane

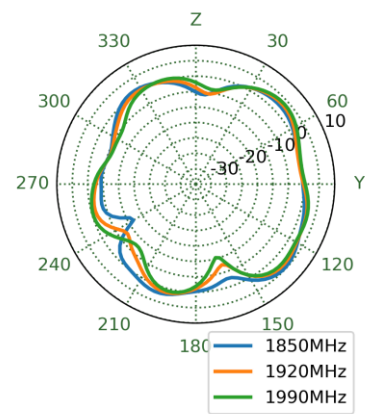
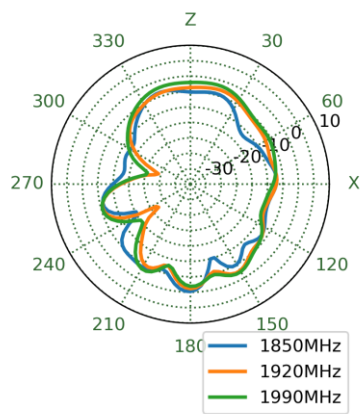
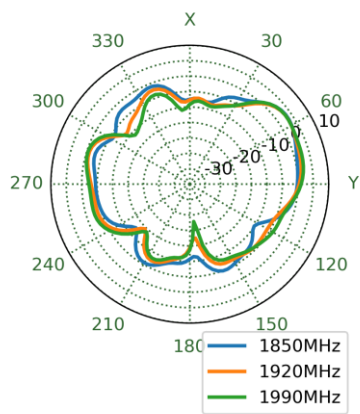

1990MHz

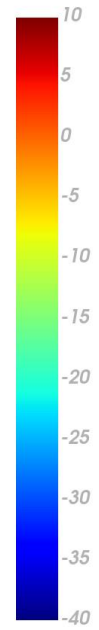
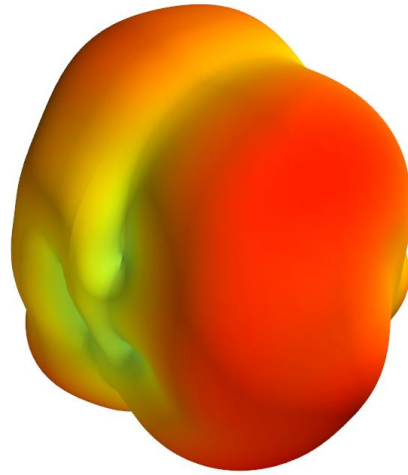

XY Plane

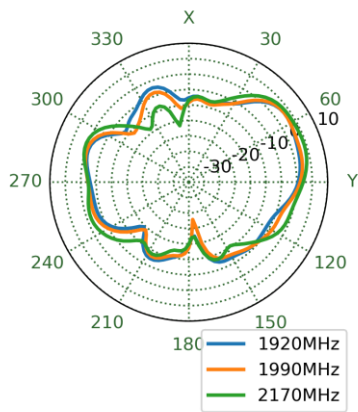

XZ Plane

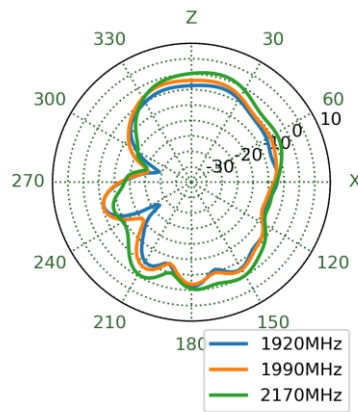

YZ Plane

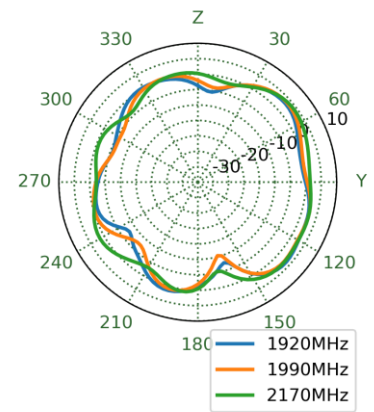

2595MHz

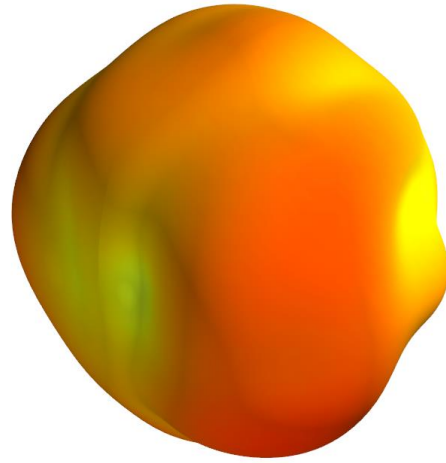

XY Plane

XZ Plane

YZ Plane

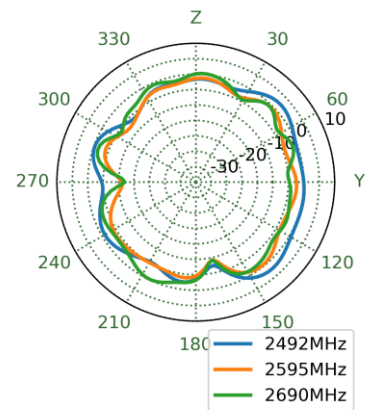
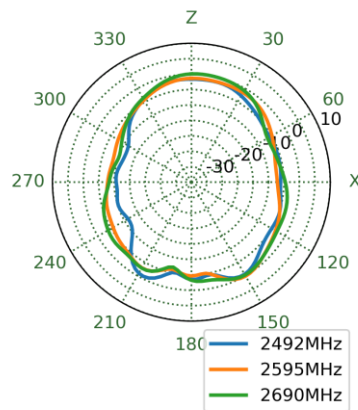
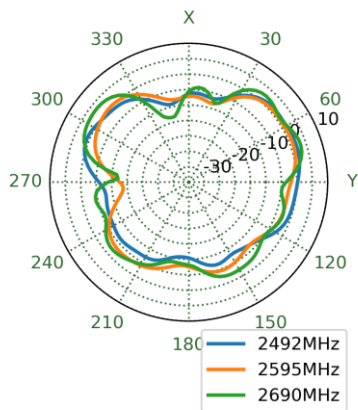

5. Mechanical Drawing (Units: mm)

ISO NO.: EDW-22-8-0138

STATE: Release

- NOTES:
1. No dregs or insufficient soldering. Solder thickness 0.3~1.7mm.
 2. The solder must be smooth and full to the edges of the pad. The solder must not extend outside of the pad area.
 3. The connector position has special orientation to the PCB as per drawing.
 4. All material must be RoHS compliant.
 5. Open/short QC, VSWR required.
 6. Soldered area:
 7. ** Critical Dimensions.

REV.	DESCRIPTION	ENG.	APPROVED	DATE
001	Initial Design	Ruby	Aaron	2022/02/24

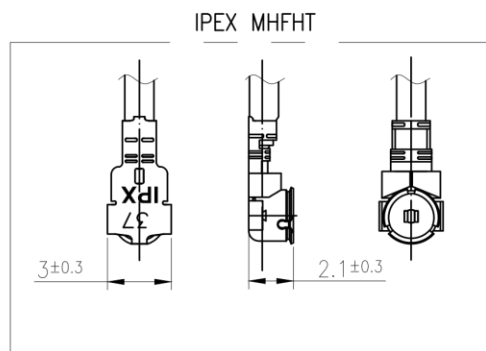
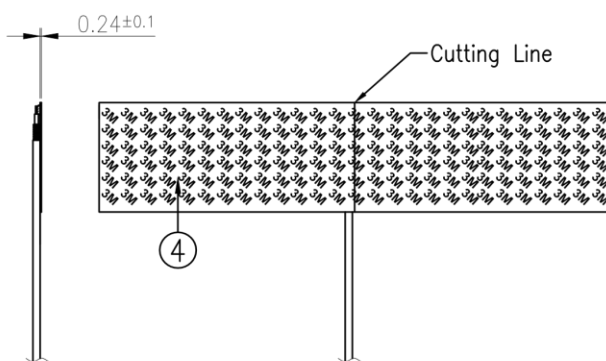
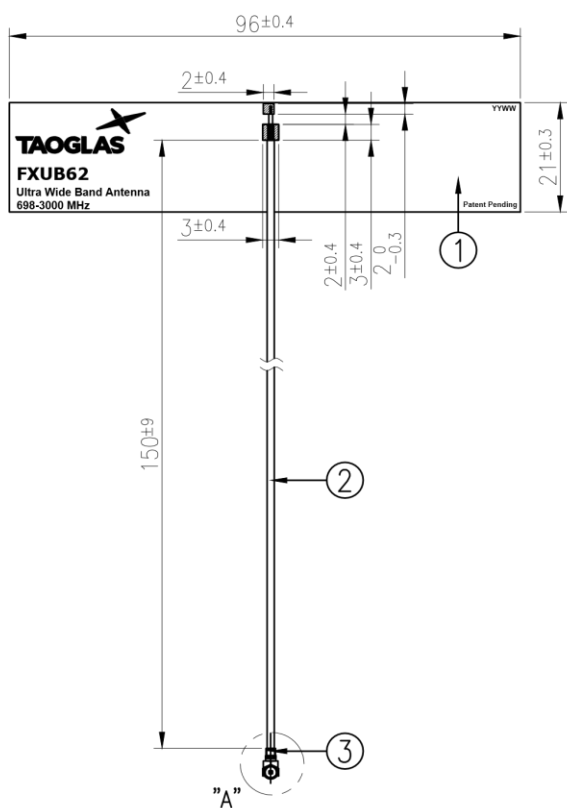
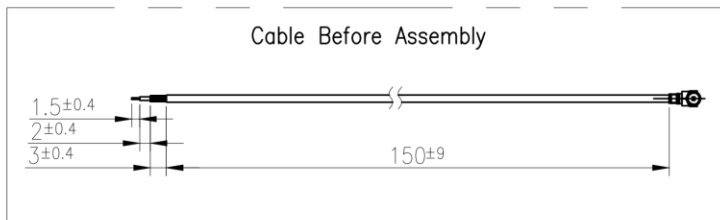

Detail A
Scale: 4:1

Name	Material	Finish	QTY
1 FXUB62 FPCB	Polymer 0.24t	Black	1
2 1.37 Coaxial Cable	FEP	Black	1
3 IPEX MHFHT	Brass	Au Plated	1
4 Double-Sided Adhesive	3M 467	Brown Liner	1

APPROVED BY: Aaron	<p>TW Design Centre This drawing and its inherent design concepts are property of Taoglas. Not to be copied or given to third parties without the written consent of Taoglas.</p>
CHECK BY: Aaron	
DRAWN BY: Ruby	
DATE: 2022/02/24	
UNLESS OTHERWISE SPECIFIED TOLERANCES ON:	<p>TITLE: Wide Band Flex Antenna 698MHz to 3GHz with 150mm 1.37 IPEX MHFHT</p> <p>PART NO.: FXUB62.07.0150C</p>
THIRD ANGLE PROJECTION	<p>UNIT: mm SCALE: 1:1.25 PAGES: 1/1 REV. D01</p>

6. Packaging

50pcs FXUB63.07.0150C per PE Bag
 Dimensions - 300*100
 Weight - 80g



2000pcs FXUB63.07.0150C per carton
 Dimensions - 320*250*230mm
 Weight - 6Kg

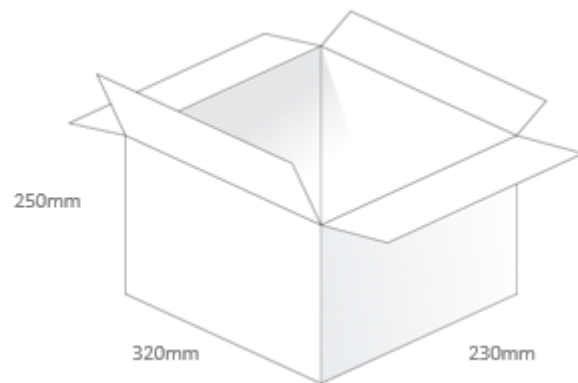

Changelog for the datasheet

SPE-22-8-086 – FXUB62.07.0150C

Revision: B (Original First Release)

Date:	2022-11-08
Notes:	Updated testing condition in spec table.
Author:	Gary West

Previous Revisions

Revision: A (Original First Release)

Date:	2022-05-28
Notes:	First Release
Author:	Jack Conroy