

# Amphenol

<http://www.amphenol.com.tw>

Amphenol East Asia Ltd., *Taiwan Branch*

5F, No.361, Fusing 1st Rd., Gueishan Township, Taoyuan County 333, Taiwan (R.O.C.)

TEL:+886-3-264-7200 FAX:+886-3-327-5296

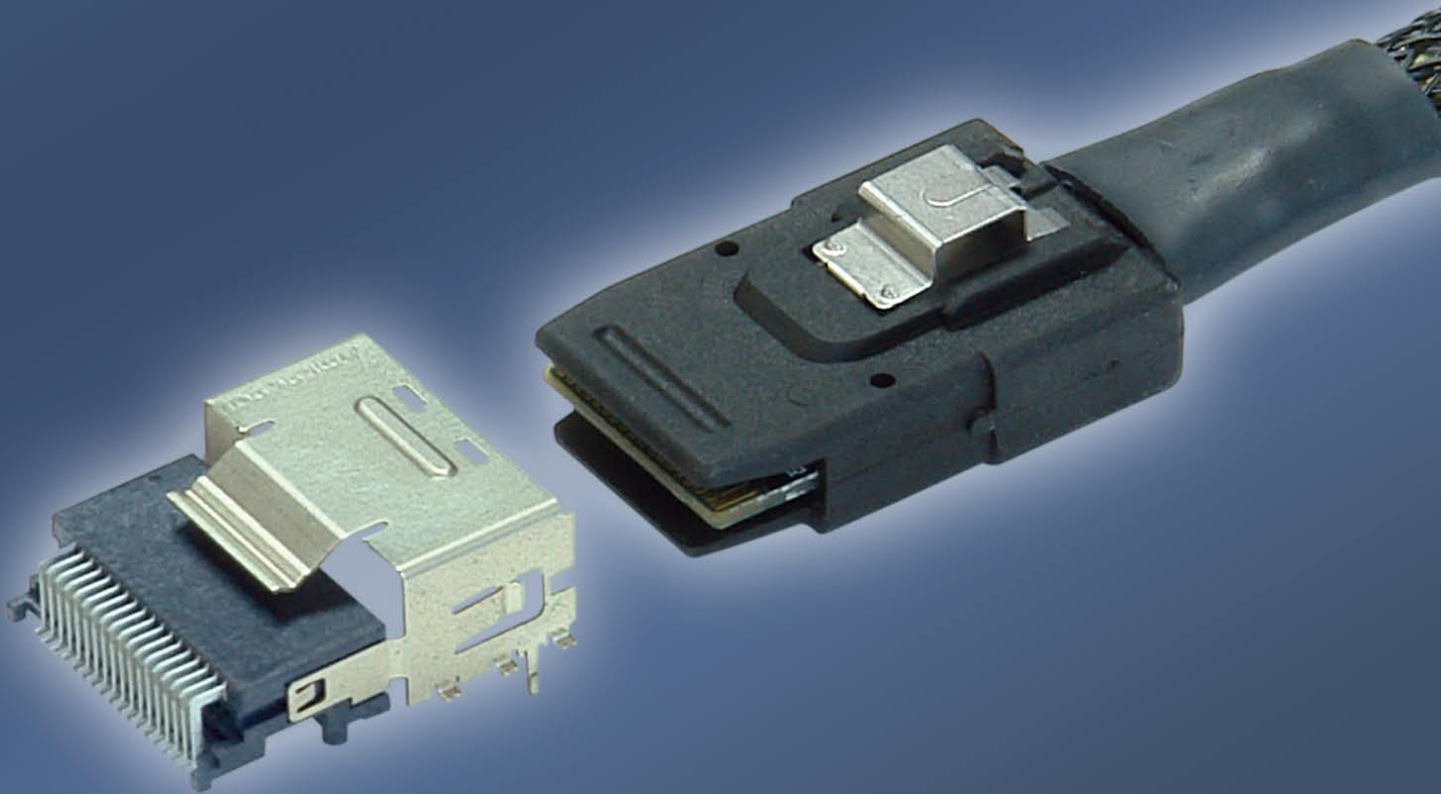

## Contents:

G40 Part Number System.....	2
G40 Part Number List Table.....	3
G40 BR & SR 36 pos Series.....	4
G40 MR & MV 36 pos Series.....	5

# mini SAS Connector

## mini SAS G40 Part Number System

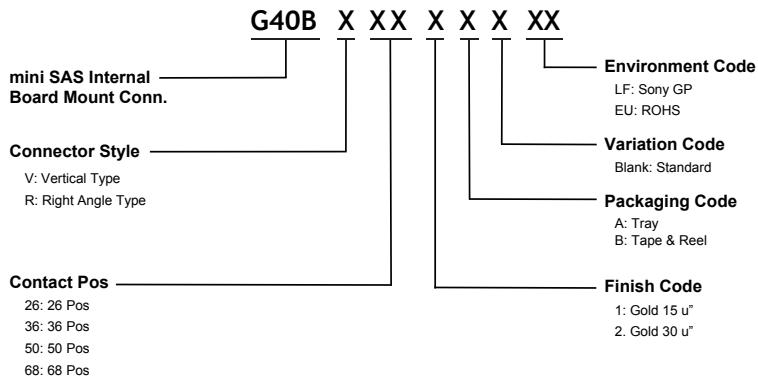

G40SR36D2EU

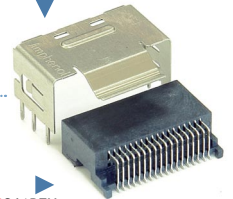

G40BR361BEU

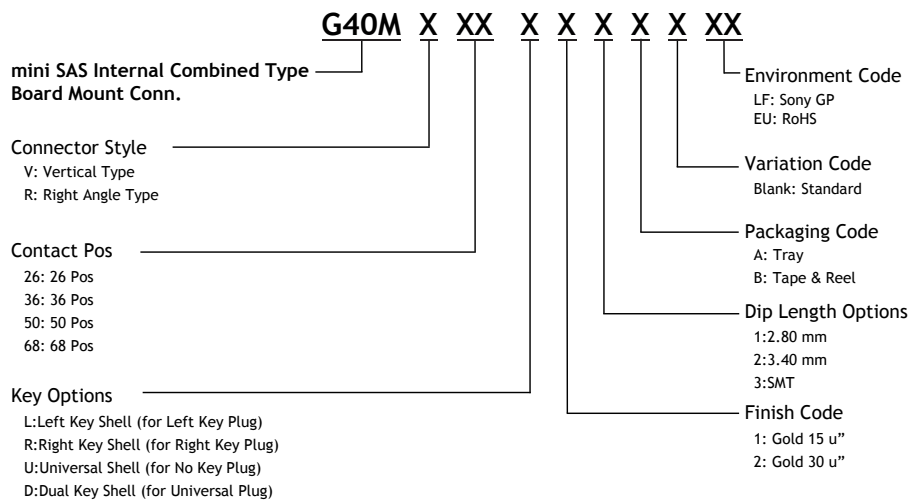
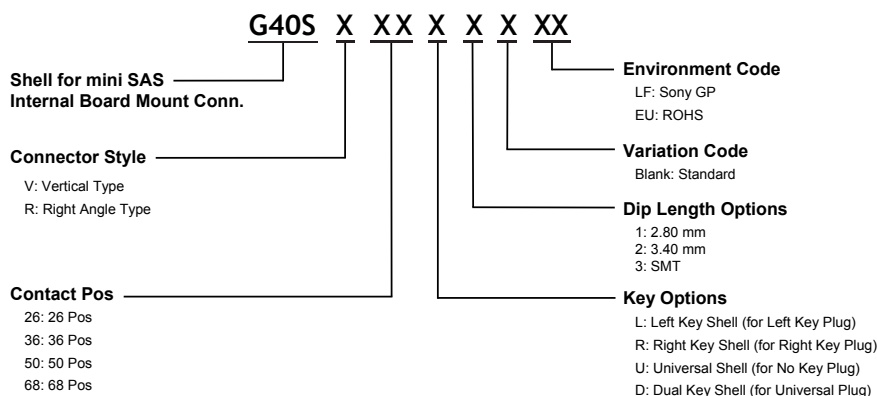

### 36-pos G40M Series

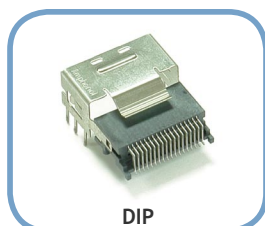

G40MR36D12AEU

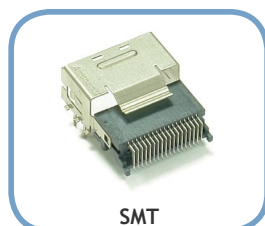

G40MR36D13AEU



G40MV36D12AEU



G40MV36D13AEU

## mini SAS G40 Part Number List Table

### Internal Separation Type

Connector ( G40BR )					
Type	Plug or Receptacle	Position	Plating	Connector P/N	Available
R/A	Receptacle	36 pos	15u"	G40BR361BEU	Y
			30u"	G40BR362BEU	Y

Cage ( G40SR )				
Position	Keying(optional)	Cage Tail Length	Cage P/N	Available
36 pos	Left Key	2.8mm	G40SR36L1EU	Y
		3.4mm	G40SR36L2EU	Y
	Right Key	2.8mm	G40SR36R1EU	Y
		3.4mm	G40SR36R2EU	Y
	Universal Shell No Key Plug	2.8mm	G40SR36U1EU	Y
		3.4mm	G40SR36U2EU	Y
	Dual Key Shell Universal Plug	2.8mm	G40SR36D1EU	Y
		3.4mm	G40SR36D2EU	Y

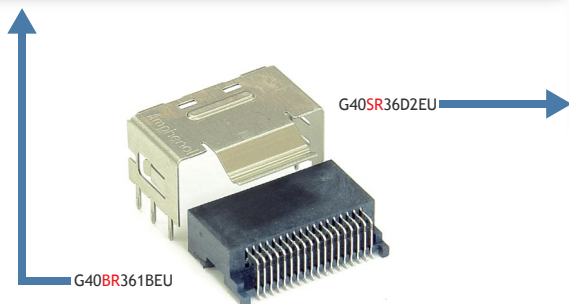

### Why combo type ?

1. One piece design for easy control the mounting process. 2. Excellent coplanarity. 3. No-gap between connector and cage.

### Internal Combo Type

Combo Type ( G40M )												
Type	Plug or Receptacle	Position	Cage Type	Keying(optional)	Shell Tail Length	Plating	P/N	Available				
R/A		36 pos	DIP	Left Key	2.8mm	15u"	G40MR36L11AEU	Y				
						30u"	G40MR36L21AEU	Y				
					3.4mm	15u"	G40MR36L12AEU	Y				
						30u"	G40MR36L22AEU	Y				
				Right Key	2.8mm	15u"	G40MR36R11AEU	Y				
						30u"	G40MR36R21AEU	Y				
					3.4mm	15u"	G40MR36R12AEU	Y				
						30u"	G40MR36R22AEU	Y				
				Universal Shell No Key Plug	2.8mm	15u"	G40MR36U11AEU	Y				
						30u"	G40MR36U21AEU	Y				
					3.4mm	15u"	G40MR36U12AEU	Y				
						30u"	G40MR36U22AEU	Y				
Dual Key Shell Universal Plug	2.8mm	15u"	G40MR36D11AEU	Y								
		30u"	G40MR36D21AEU	Y								
	3.4mm	15u"	G40MR36D12AEU	Y								
		30u"	G40MR36D22AEU	Y								
R/A		36 pos	SMT	Left Key	2.8mm	15u"	G40MR36L13AEU	Y				
						30u"	G40MR36L23AEU	Y				
						3.4mm	15u"	G40MR36R13AEU	Y			
							30u"	G40MR36R23AEU	Y			
				Right Key	2.8mm	15u"	G40MR36U13AEU	Y				
						30u"	G40MR36U23AEU	Y				
					3.4mm	15u"	G40MR36D13AEU	Y				
						30u"	G40MR36D23AEU	Y				
				Vertical		36 pos	DIP	Left Key	2.8mm	15u"	G40MV36L11AEU	Y
										30u"	G40MV36L21AEU	Y
									3.4mm	15u"	G40MV36L12AEU	Y
										30u"	G40MV36L22AEU	Y
Right Key	2.8mm	15u"	G40MV36R11AEU					Y				
		30u"	G40MV36R21AEU					Y				
	3.4mm	15u"	G40MV36R12AEU					Y				
		30u"	G40MV36R22AEU					Y				
Universal Shell No Key Plug	2.8mm	15u"	G40MV36U11AEU					Y				
		30u"	G40MV36U21AEU					Y				
	3.4mm	15u"	G40MV36U12AEU					Y				
		30u"	G40MV36U22AEU					Y				
Dual Key Shell Universal Plug	2.8mm	15u"	G40MV36D11AEU	Y								
		30u"	G40MV36D21AEU	Y								
	3.4mm	15u"	G40MV36D12AEU	Y								
		30u"	G40MV36D22AEU	Y								
Vertical		36 pos	SMT	Left Key	2.8mm	15u"	G40MV36L13AEU	Y				
						30u"	G40MV36L23AEU	Y				
						3.4mm	15u"	G40MV36R13AEU	Y			
							30u"	G40MV36R23AEU	Y			
				Right Key	2.8mm	15u"	G40MV36U13AEU	Y				
						30u"	G40MV36U23AEU	Y				
					3.4mm	15u"	G40MV36D13AEU	Y				
						30u"	G40MV36D23AEU	Y				

## mini SAS G40 BR & SR 36 pos Series

### G40BR 36 pos Series

mini SAS 36 pos Board Mount Right Angle SMT

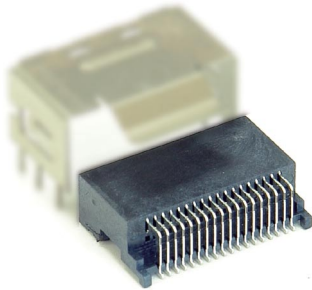

**G40BR361BEU**

Drawing for mini SAS

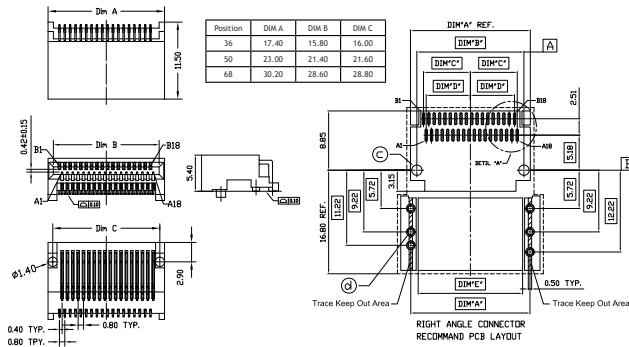

Amphenol offers a full range of mini SAS Interconnect System for both connector and cable assemblies.

In particular, Amphenol offers conversion cable to legacy SFF-8484 4X SAS interfaces and break-out cable to individual SATA or SAS drives. The cable assemblies provide 100Ω differential impedance with tight skew control and low cross talk. They also offer multiple cable lengths as a standard, as well as customized lengths upon request.

### mini SAS 36 pos Application to SERVER Motherboard

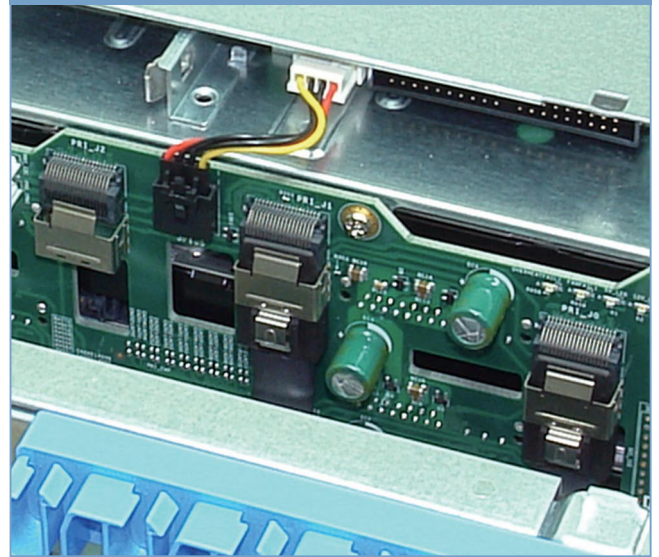

### G40SR 36 pos Series

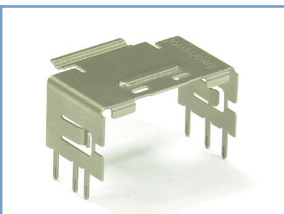

Right Angle Shell Dual Key

**G40SR36D2EU**

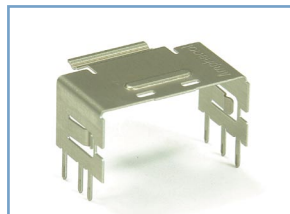

Right Angle Shell Universal Key

**G40SR36U2EU**

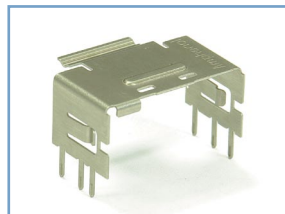

Right Angle Shell Left Key

**G40SR36L2EU**

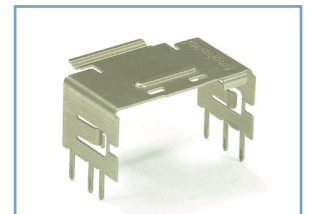

Right Angle Shell Right Key

**G40SR36R2EU**

### Drawing for mini SAS

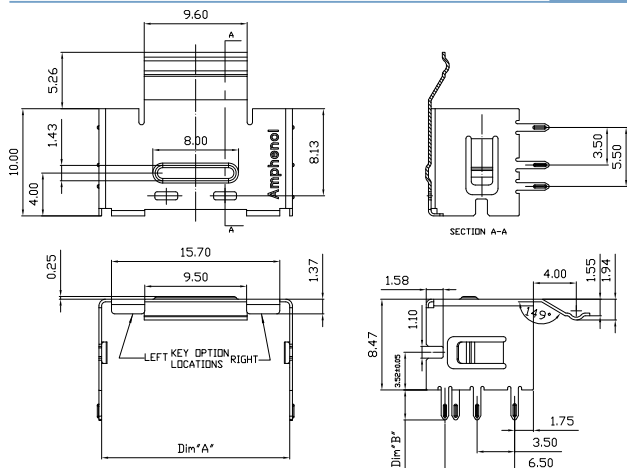

POSITION	DIM A*	DIM B*
26	13.55	2.8/3.4
36	17.55	2.8/3.4
50	23.15	2.8/3.4
68	30.35	2.8/3.4

### G40SR DIP Options

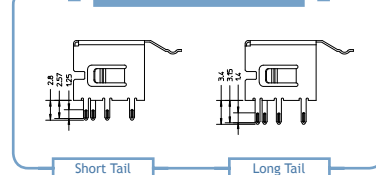

### G40SR Key Options

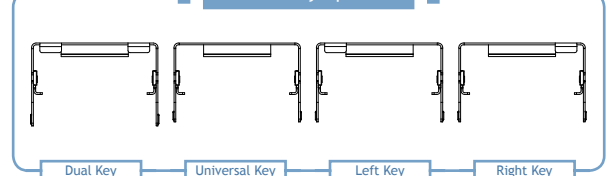

## mini SAS G40 MR & MV 36 pos Series

mini SAS 36 pos Combo Type Board Mount  
Right Angle Connector DIP Cage

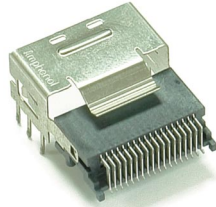

**G40MR36D12AEU**

Drawing for mini SAS

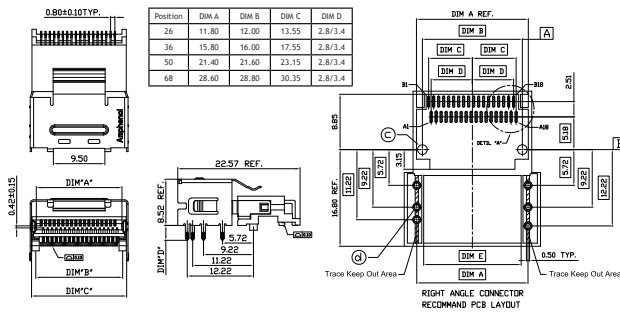

mini SAS 36 pos Straight DIP Type Board Mount Connector



**G40MV36D12AEU**

Drawing for mini SAS

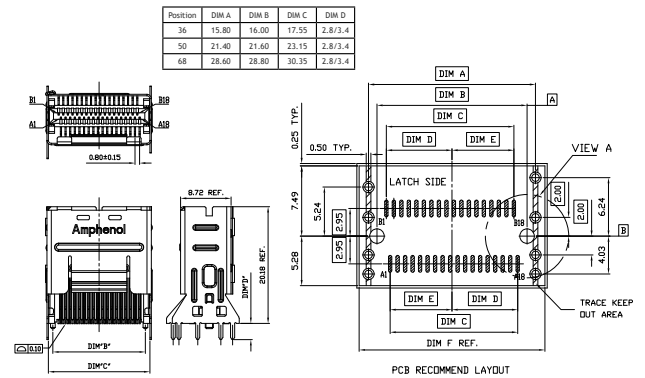

mini SAS 36 pos Combo Type Board Mount  
Right Angle Connector SMT Cage

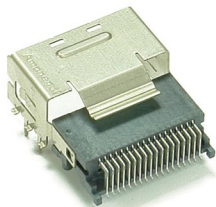

**G40MR36D13AEU**

Drawing for mini SAS

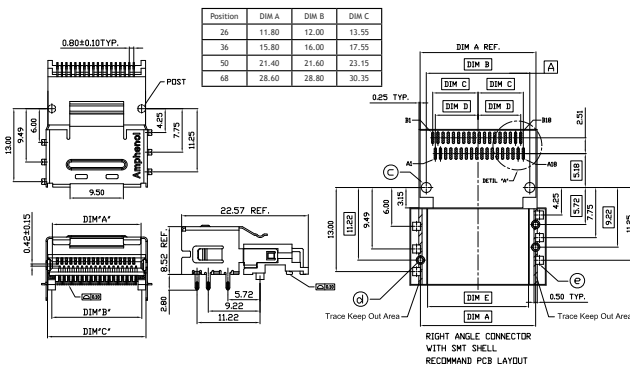

mini SAS 36 pos Straight SMT Type Board Mount Connector

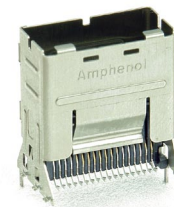

**G40MV36D13AEU**

Drawing for mini SAS

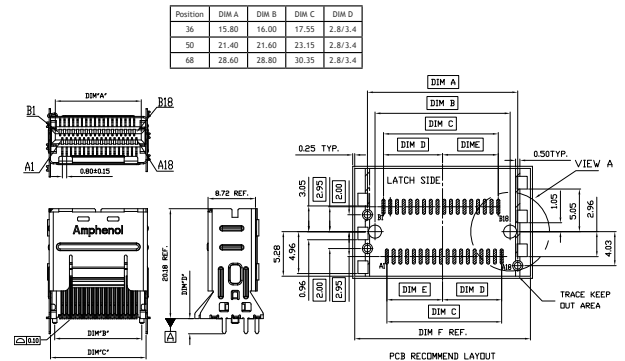

### G40MR Key Options & DIP Options



Dual Key



Universal Key

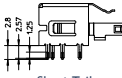

Short Tail



Left Key



Right Key

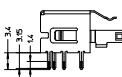

Long Tail

### G40MV Key Options



Dual Key



Universal Key

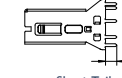

Short Tail



Left Key



Right Key

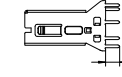

Long Tail