

Amphenol

<http://www.amphenol.com.tw>

Amphenol East Asia Ltd., *Taiwan Branch*

5F, No.361, Fusing 1st Rd., Gueishan Township, Taoyuan County 333, Taiwan (R.O.C.)

TEL:+886-3-264-7200 FAX:+886-3-327-5296

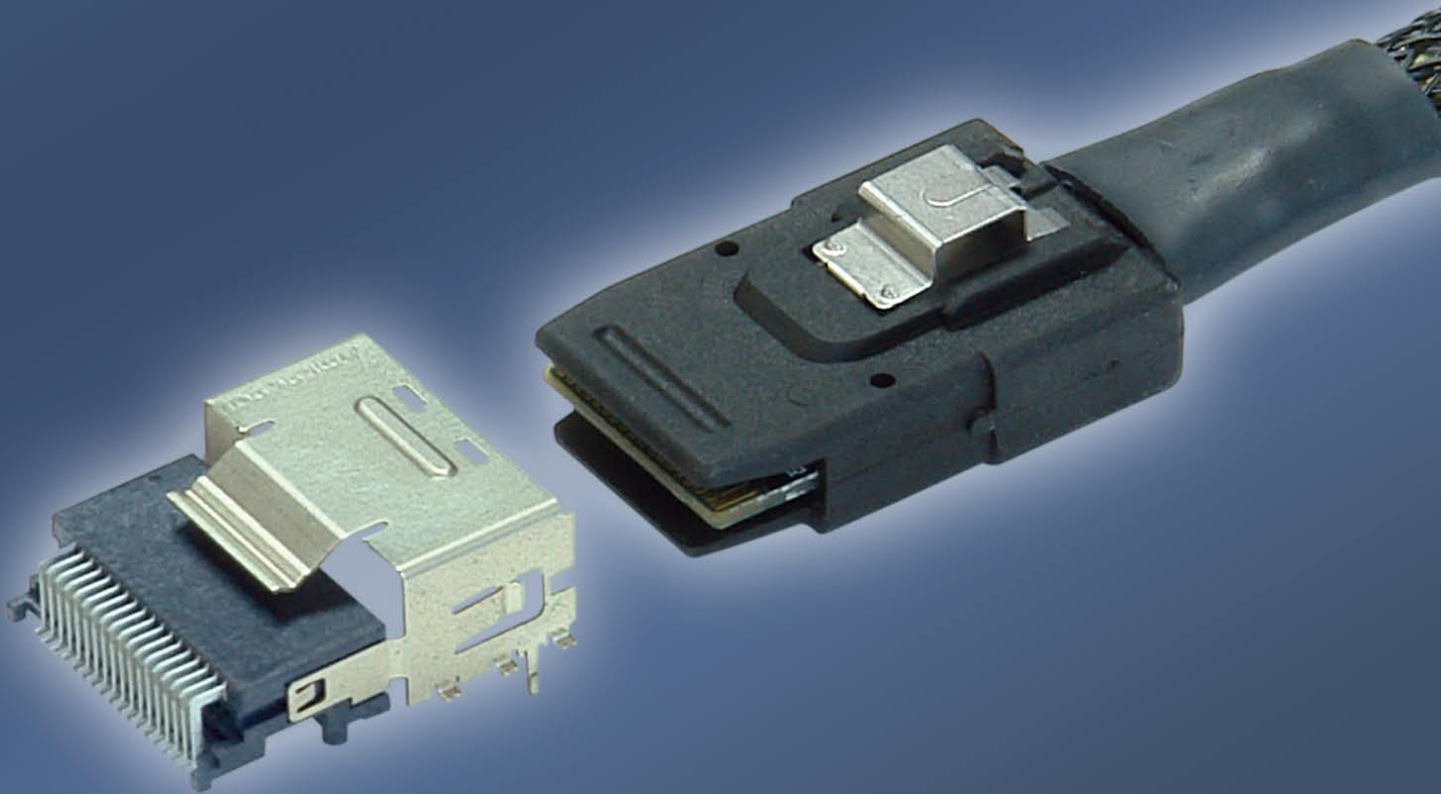

Contents:

G40 Part Number System.....	2
G40 Part Number List Table.....	3
G40 BR & SR 36 pos Series.....	4
G40 MR & MV 36 pos Series.....	5

mini SAS Connector

mini SAS G40 Part Number System

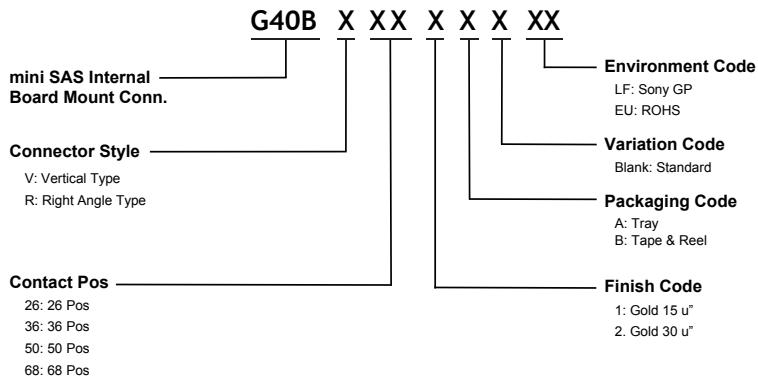

G40SR36D2EU

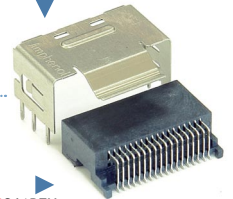

G40BR361BEU

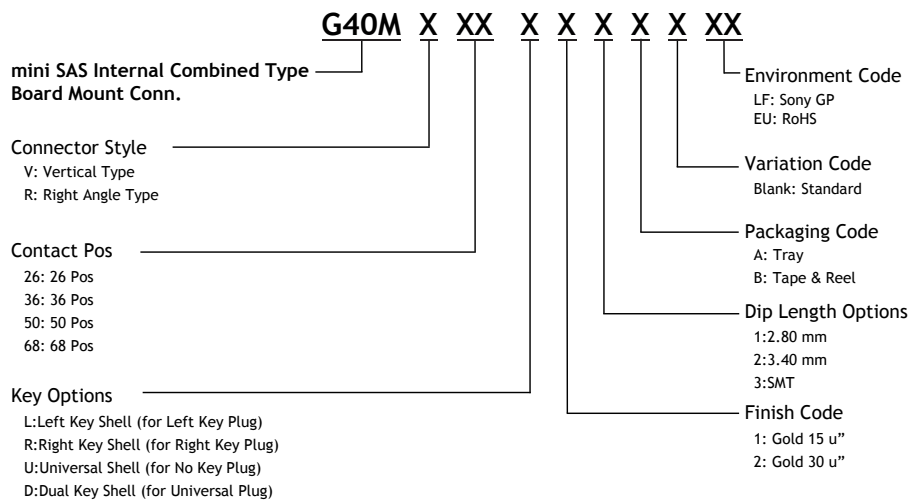
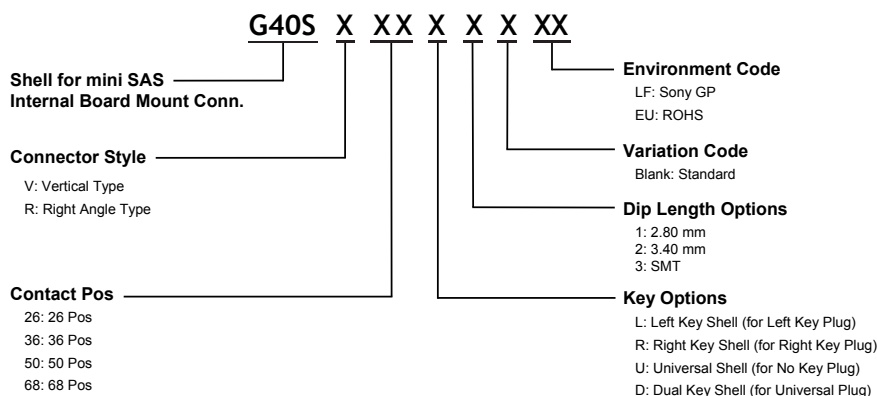

36-pos G40M Series

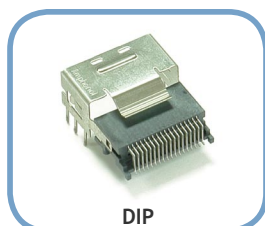

G40MR36D12AEU

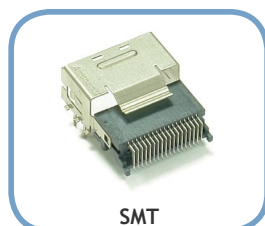

G40MR36D13AEU



G40MV36D12AEU



G40MV36D13AEU

mini SAS G40 Part Number List Table

Internal Separation Type

Connector (G40BR)					
Type	Plug or Receptacle	Position	Plating	Connector P/N	Available
R/A	Receptacle	36 pos	15u"	G40BR361BEU	Y
			30u"	G40BR362BEU	Y

Cage (G40SR)				
Position	Keying(optional)	Cage Tail Length	Cage P/N	Available
36 pos	Left Key	2.8mm	G40SR36L1EU	Y
		3.4mm	G40SR36L2EU	Y
	Right Key	2.8mm	G40SR36R1EU	Y
		3.4mm	G40SR36R2EU	Y
	Universal Shell No Key Plug	2.8mm	G40SR36U1EU	Y
		3.4mm	G40SR36U2EU	Y
	Dual Key Shell Universal Plug	2.8mm	G40SR36D1EU	Y
		3.4mm	G40SR36D2EU	Y

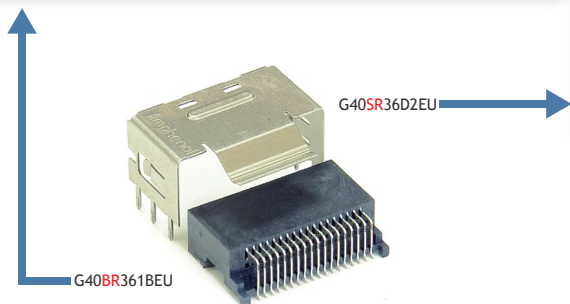

Why combo type ?

1. One piece design for easy control the mounting process. 2. Excellent coplanarity. 3. No-gap between connector and cage.

Internal Combo Type

Combo Type (G40M)												
Type	Plug or Receptacle	Position	Cage Type	Keying(optional)	Shell Tail Length	Plating	P/N	Available				
R/A		36 pos	DIP	Left Key	2.8mm	15u"	G40MR36L11AEU	Y				
						30u"	G40MR36L21AEU	Y				
					3.4mm	15u"	G40MR36L12AEU	Y				
						30u"	G40MR36L22AEU	Y				
				Right Key	2.8mm	15u"	G40MR36R11AEU	Y				
						30u"	G40MR36R21AEU	Y				
					3.4mm	15u"	G40MR36R12AEU	Y				
						30u"	G40MR36R22AEU	Y				
				Universal Shell No Key Plug	2.8mm	15u"	G40MR36U11AEU	Y				
						30u"	G40MR36U21AEU	Y				
					3.4mm	15u"	G40MR36U12AEU	Y				
						30u"	G40MR36U22AEU	Y				
Dual Key Shell Universal Plug	2.8mm	15u"	G40MR36D11AEU	Y								
		30u"	G40MR36D21AEU	Y								
	3.4mm	15u"	G40MR36D12AEU	Y								
		30u"	G40MR36D22AEU	Y								
R/A		36 pos	SMT	Left Key	2.8mm	15u"	G40MR36L13AEU	Y				
						30u"	G40MR36L23AEU	Y				
					3.4mm	15u"	G40MR36R13AEU	Y				
						30u"	G40MR36R23AEU	Y				
				Right Key	2.8mm	15u"	G40MR36U13AEU	Y				
						30u"	G40MR36U23AEU	Y				
					3.4mm	15u"	G40MR36D13AEU	Y				
						30u"	G40MR36D23AEU	Y				
				Vertical		36 pos	DIP	Left Key	2.8mm	15u"	G40MV36L11AEU	Y
										30u"	G40MV36L21AEU	Y
									3.4mm	15u"	G40MV36L12AEU	Y
										30u"	G40MV36L22AEU	Y
Right Key	2.8mm	15u"	G40MV36R11AEU					Y				
		30u"	G40MV36R21AEU					Y				
	3.4mm	15u"	G40MV36R12AEU					Y				
		30u"	G40MV36R22AEU					Y				
Universal Shell No Key Plug	2.8mm	15u"	G40MV36U11AEU					Y				
		30u"	G40MV36U21AEU					Y				
	3.4mm	15u"	G40MV36U12AEU					Y				
		30u"	G40MV36U22AEU					Y				
Dual Key Shell Universal Plug	2.8mm	15u"	G40MV36D11AEU	Y								
		30u"	G40MV36D21AEU	Y								
	3.4mm	15u"	G40MV36D12AEU	Y								
		30u"	G40MV36D22AEU	Y								
Vertical		36 pos	SMT	Left Key	2.8mm	15u"	G40MV36L13AEU	Y				
						30u"	G40MV36L23AEU	Y				
					3.4mm	15u"	G40MV36R13AEU	Y				
						30u"	G40MV36R23AEU	Y				
				Right Key	2.8mm	15u"	G40MV36U13AEU	Y				
						30u"	G40MV36U23AEU	Y				
					3.4mm	15u"	G40MV36D13AEU	Y				
						30u"	G40MV36D23AEU	Y				

mini SAS G40 BR & SR 36 pos Series

G40BR 36 pos Series

mini SAS 36 pos Board Mount Right Angle SMT

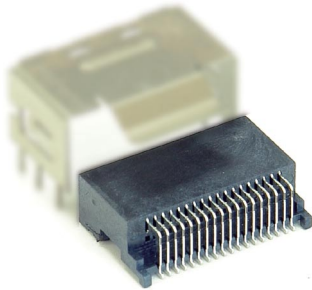

G40BR361BEU

Drawing for mini SAS

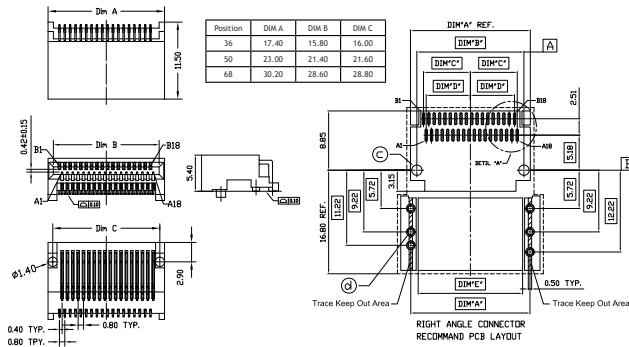

Amphenol offers a full range of mini SAS Interconnect System for both connector and cable assemblies.

In particular, Amphenol offers conversion cable to legacy SFF-8484 4X SAS interfaces and break-out cable to individual SATA or SAS drives. The cable assemblies provide 100Ω differential impedance with tight skew control and low cross talk. They also offer multiple cable lengths as a standard, as well as customized lengths upon request.

mini SAS 36 pos Application to SERVER Motherboard

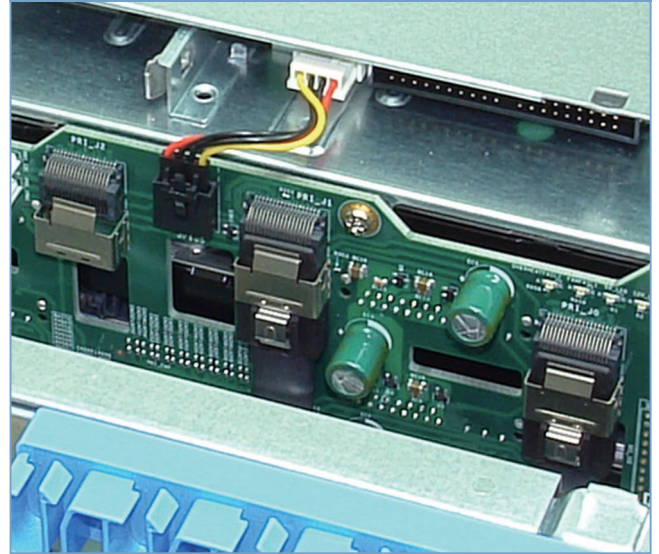

G40SR 36 pos Series

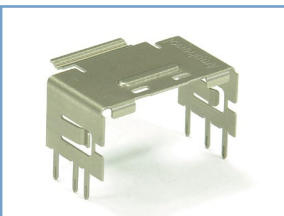

Right Angle Shell Dual Key

G40SR36D2EU

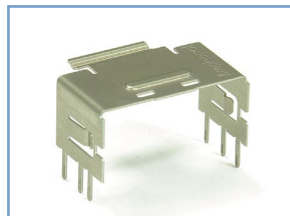

Right Angle Shell Universal Key

G40SR36U2EU

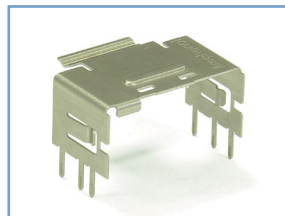

Right Angle Shell Left Key

G40SR36L2EU

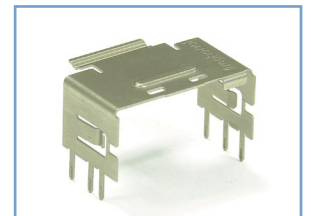

Right Angle Shell Right Key

G40SR36R2EU

Drawing for mini SAS

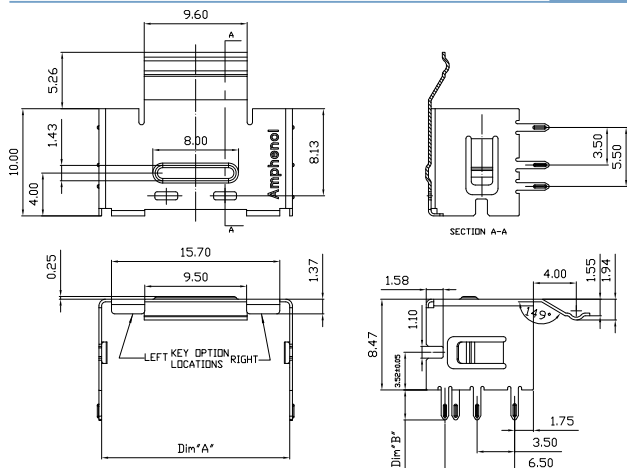

POSITION	DIM A*	DIM B*
26	13.55	2.8/3.4
36	17.55	2.8/3.4
50	23.15	2.8/3.4
68	30.35	2.8/3.4

G40SR DIP Options

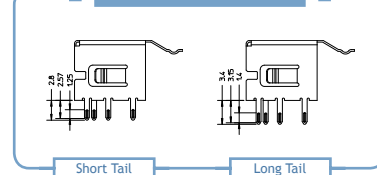

G40SR Key Options

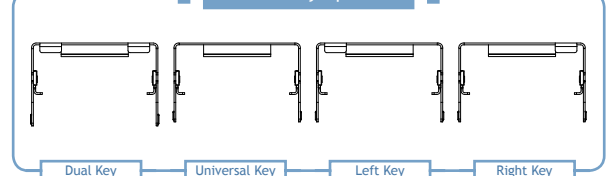

mini SAS G40 MR & MV 36 pos Series

mini SAS 36 pos Combo Type Board Mount
Right Angle Connector DIP Cage

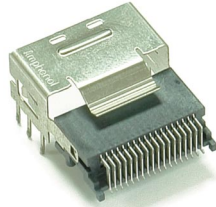

G40MR36D12AEU

Drawing for mini SAS

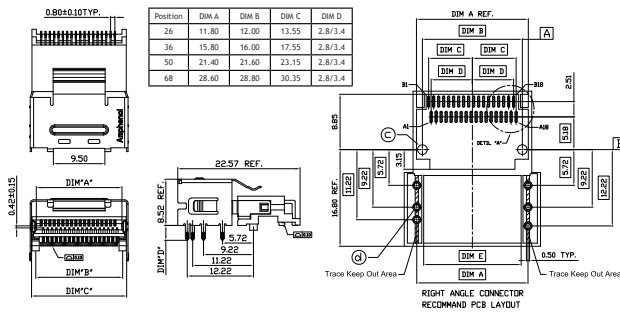

mini SAS 36 pos Straight DIP Type Board Mount Connector



G40MV36D12AEU

Drawing for mini SAS

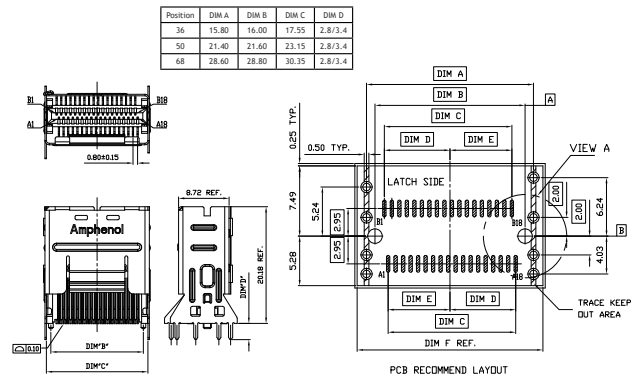

mini SAS 36 pos Combo Type Board Mount
Right Angle Connector SMT Cage

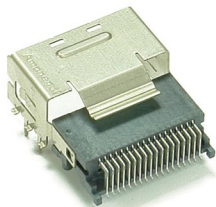

G40MR36D13AEU

Drawing for mini SAS

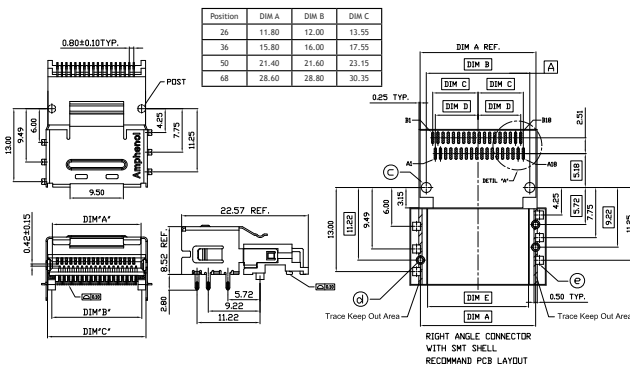

mini SAS 36 pos Straight SMT Type Board Mount Connector

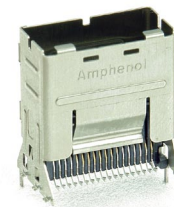

G40MV36D13AEU

Drawing for mini SAS

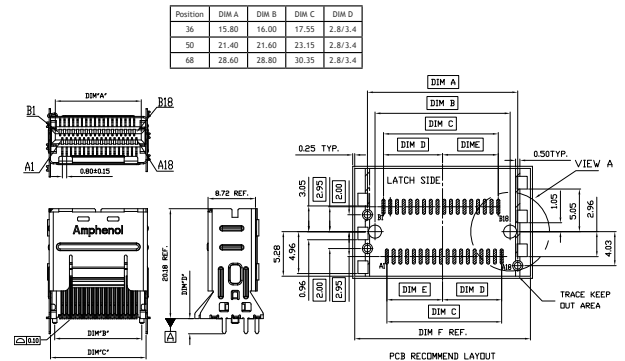

G40MR Key Options & DIP Options



Dual Key



Universal Key

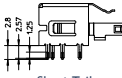

Short Tail



Left Key



Right Key

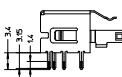

Long Tail

G40MV Key Options



Dual Key



Universal Key

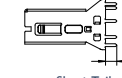

Short Tail



Left Key



Right Key

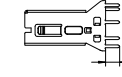

Long Tail