

I/O Relay Terminal G70V

I/O Relay Terminals with 16 Points and Push-In Plus Terminal Blocks to Downsize Control Panels Reduce Wiring Time



- Wiring time is reduced by 60% compared to traditional screw terminals.
- I/O Relay Terminals with 16 points accept G2RV Slim I/O Relays or G3RV SSRs.
- Work is reduced even further with one-step cable connection to the PLC.
- Diode provided for coil surge absorption.
- Operation indicators for immediate recognition of I/O signal status.
- DIN Track or screw mounting.
- New models provide internal common connections between I/O terminals to further reduce wiring work. (input models: 16 point/common; output models: 4 points/common)



For the most recent information on models that have been certified for safety standards, refer to your OMRON website.

* According to OMRON actual measurement data from November 2015.

Refer to *Safety Precautions* on page 15.

Model Number Legend

G70V - □ □ □ 16 P - □ - □
 (1) (2) (3) (4) (5) (6) (7)

- (1) Mountable Relays
 - S: Relays
 - Z: Sockets
- (2) Input/Output Classification
 - I: For input
 - O: For output
- (3) I/O Specification
 - C: Contacts
 - (Applicable when (2) is O (for output) (relay output).)
 - D: DC (Applicable when (2) is I (for input) (coil for input).)
 - M: AC/DC (Applicable when (1) is Z (Sockets).)
- (4) Number of I/O Points
 - 16: 16 points
- (5) Terminal Type
 - P: Push-In Plus terminal blocks
- (6) Common Line on Connector Side
 - Blank: NPN
 - 1: PNP
- (7) Common Line on Terminal Block Side
 - Blank: No internal connections
 - C4: Every 4 points internally connected at terminal block bottom row
 - C4-D: Every 4 points internally connected at terminal block middle row
 - C16: 16 points internally connected

(For Input NPN)

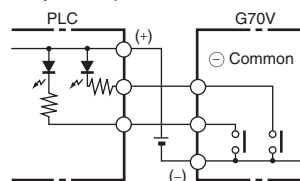

(For Input PNP)

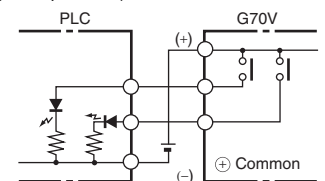

(For Output NPN)

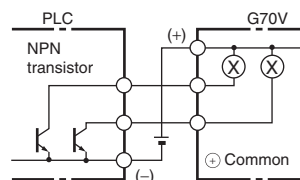

(For Output PNP)

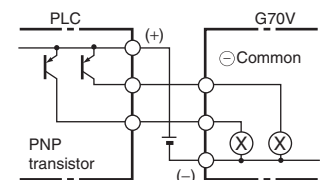

G70V

Ordering Information

I/O Relay Terminals

Terminals	Classification	Points	Common Line		Rated voltage	Model
			Terminal Block Side	Connector Side		
Push-In Plus terminal blocks	Input *1	16	No internal connections	NPN (– common)	24 VDC	G70V-SID16P
				PNP (+ common)		G70V-SID16P-1
			16 points internally connected	NPN (– common)		G70V-SID16P-C16
				PNP (+ common)		G70V-SID16P-1-C16
	Output *2		No internal connections	NPN (+ common)		G70V-SOC16P
				PNP (– common)		G70V-SOC16P-1
			Every 4 points internally connected at terminal block bottom row	NPN (+ common)		G70V-SOC16P-C4
				PNP (– common)		G70V-SOC16P-1-C4

*1. Mountable Relays: G2RV-1-S-AP-G DC21V.

*2. Mountable Relays: G2RV-1-S-G DC21V.

I/O Terminal Sockets

Applicable I/O Relay Terminal	Classification	Common Line		Model
		Terminal Block Side	Connector Side	
G70V-SID16P	Input	No internal connections	NPN (– common)	G70V-ZID16P
G70V-SID16P-1			PNP (+ common)	G70V-ZID16P-1
G70V-SID16P-C16		16 points internally connected	NPN (– common)	G70V-ZID16P-C16
G70V-SID16P-1-C16			PNP (+ common)	G70V-ZID16P-1-C16
G70V-SOC16P	Output	No internal connections	NPN (+ common)	G70V-ZOM16P
G70V-SOC16P-1			PNP (– common)	G70V-ZOM16P-1
G70V-SOC16P-C4		Every 4 points internally connected at terminal block bottom row	NPN (+ common)	G70V-ZOM16P-C4
G70V-SOC16P-1-C4			PNP (– common)	G70V-ZOM16P-1-C4
--- *		Every 4 points internally connected at terminal block middle row	PNP (– common)	G70V-ZOM16P-1-C4-D

Note: Relays are not mounted to the G70V-ZID/ZOM16P(-1) I/O Terminal Sockets. Combine the I/O Terminal Sockets with Slim I/O Relays or Slim I/O SSRs.

* The G70V-ZOM16P-1-C4-D does not come with SSRs. Use Slim I/O SSRs (for DC: G3RV-D03SL).

Accessories (Order Separately)

Mountable Relays

Applicable I/O Relay Terminal	Classification	Type		Model	
G70V-SID16P(-1)(-C16) G70V-ZID16P(-1)(-C16)	Input	Slim I/O Relays *1		G2RV-1-S-AP-G DC21	
G70V-SOC16P(-1)(-C4) G70V-ZOM16P(-1)(-C4)	Output	Slim I/O Relays	No Latching Lever *2	G2RV-1-S-G DC21	
			Latching Lever	G2RV-1-SI-G DC21	
		Slim I/O SSRs	For AC	Zero cross function	G3RV-202S DC24
				No zero cross function	G3RV-202SL DC24
G70V-ZOM16P-1-C4-D *3	Output	Slim I/O SSRs	For DC	G3RV-D03SL DC24	
			For DC	G3RV-D03SL DC24	

Note: To use Slim I/O SSRs, either remove the Slim I/O Relays to mount them or order a I/O Terminal Sockets and I/O SSRs separately and combine them.

*1. G2RV-1-S-AP-G Slim I/O Relays are mounted to G70V-SID16P(-1)(-C16) I/O Relay Terminals as a standard feature.

*2. G2RV-1-S-G Slim I/O Relays are mounted to G70V-SOC16P(-1)(-C4) I/O Relay Terminals as a standard feature.

*3. The G70V-ZOM16P-1-C4-D does not come with SSRs. Use Slim I/O SSRs (for DC: G3RV-D03SL).

When ordering, designate the rated voltage.

Cables for I/O Relay Terminals XW2Z-R



- Cable with Loose Wire and Crimp Terminals: XW2Z-RY□C
- Cable with Loose Wires: XW2Z-RA□C
- Cable with connectors
 - Fujitsu connectors
 - (1:1): XW2Z-R□C
 - (1:2): XW2Z-RI□C-□
 - XW2Z-RO□C-□
 - (1:3): XW2Z-R□C-□-□
 - (1:1): XW2Z-RI□C
 - XW2Z-RO□C
 - (1:2): XW2Z-RI□-□-D□
 - XW2Z-RM□-□-D□
 - XW2Z-RO□-□-D1

Refer to *Connecting Cables* on page 17 for details.

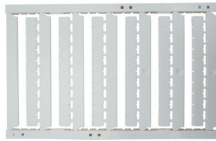
Labels

Appearance	Model	Minimum order (sheet) (quantity per sheet)
	XW5Z-P2.5LB2	5 (1 sheet / 72 pieces)

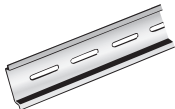
Accessories for DIN Track Mounting

Appearance	Name	Model	Minimum order (quantity)
	DIN Tracks	1 m	1
		0.5 m	
	End Plate	PFP-M	10
	Spacer	PFP-S	

* These products must be ordered in sets of 10.

Refer to your OMRON website for details on the PFP-□.

Mounting Example Using the Accessories

Mounting to DIN Track

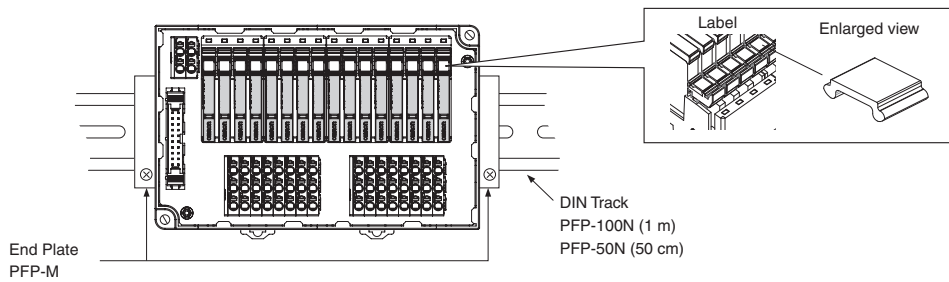

G70V

Specifications

Coil Ratings (Common to Input/Output per Relay)

Item	Rated current (mA)	Coil resistance (Ω)	Must operate of rated voltage	Must release of rated voltage	Maximum voltage of rated voltage	Power consumption (mW)
Rated voltage (V)	13.3	1575	80% max.	10% min.	110%	Approx. 280

- Note:**
1. The rated current and coil resistance are measured at a coil temperature of 23°C with a tolerance of $\pm 15\%$ for coil resistance.
 2. The operating characteristics are measured at a coil temperature of 23°C.
 3. The value for maximum voltage is the maximum value within the allowable voltage fluctuation range for the relay coil's operating power supply. Continuous operation at this voltage is not within product specifications.
 4. The rated current includes the current for the indicators on the I/O Relay Terminal.

Contact Ratings (G2RV-1-S-G I/O Relay)

Classification	For input		For output	
	Resistive load ($\cos\phi=1$)		Inductive load ($\cos\phi=0.4$ L/R=7 ms)	
Rated load	50 mA at 30 VAC 50 mA at 36 VDC	6 A at 250 VAC 6 A at 30 VDC	2.5 A at 250 VAC 2 A at 30 VDC	
Rated carry current	50 mA	6 A/point, 10 A/common		
Max. switching voltage	30 VAC, 36 VDC	250 VAC, 125 VDC		
Max. switching current	50 mA	6 A/point, 10 A/common		
Maximum switching capacity	---	1,500 VA 180 W	500 VA 60 W	
Error rate (reference value) *	1 mA at 100 mVDC	10 mA at 5 VDC		
Electrical endurance	5,000,000 operations min.	NO contacts: 70,000 operations min. NC contacts: 50,000 operations min.		
Mechanical endurance	5,000,000 operations min.	5,000,000 operations min.		

* The above values are for a switching frequency of 120 operations/min.

Characteristics

Item	Model	G70V-SID16P(-1)(-C16) (Input, DC coil)	G70V-SOC16P(-1)(-C4) (output, DC coil)
Contact form		SPST-NO \times 16	SPDT \times 16
Contact material		Ag alloy + Au plating	Ag alloy
Contact resistance *1		150 m Ω max.	
Must Operate time *2		20 ms max.	
Release time *2		40 ms max.	
Max. switching frequency	Mechanical limit	18,000 operations/h	
	At rated load	1,800 operations/h (under rated load)	
Insulation resistance		100 M Ω min.	
Dielectric strength		Between coil and contacts: 2,500 VAC for 1 min	
Vibration resistance		100 m/s ²	
Shock resistance		100 m/s ² , 3 times each in 6 directions along 3 axes	
Noise immunity		Noise level: 1.5 kV; pulse width: 100 ns to 1 μ s	
Ambient operating temperature		-40 to 55°C (with no icing or condensation)	
Ambient operating humidity		35% to 85%	
LED color	Power supply	Green	
	I/O	Yellow	
Weight		Approx. 350 g	Approx. 370 g

Note: The above values are initial values.

*1. Measurement: 1 A at 5 VDC.

*2. Ambient temperature: 23°C.

Applicable Standards

- UL 61010-2-201, CAN/CSA-C22.2 No.61010-2-201, TÜV (EN 61810-1)

Engineering Data (Reference Value)

Endurance Curve (NO Contacts)

G70V-SOC16P(-1)(-C4)

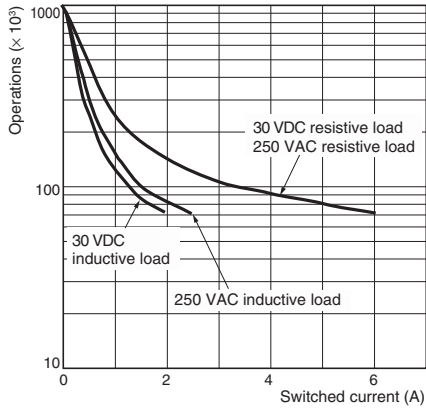

Note: These data are actual measured values that were sampled from the production line and prepared in graph format, and are for reference purposes only. A relay is manufactured by mass production, and as a basic rule must be used with allowance made for a certain amount of deviation.

Load Current vs. Ambient Temperature

G70V-SOC16P(-1)(-C4)

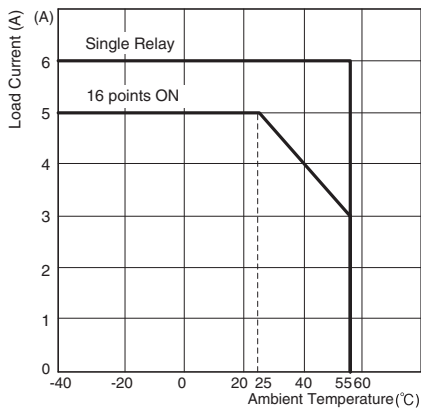

G3RV-202S DC24

G3RV-202SL DC24

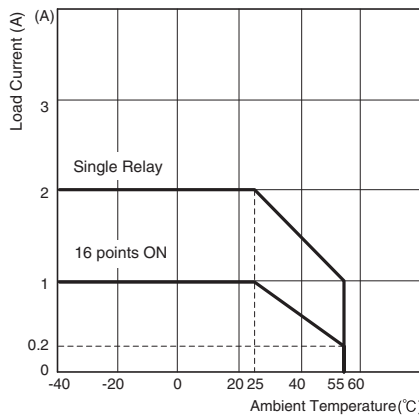

G3RV-D03 DC24

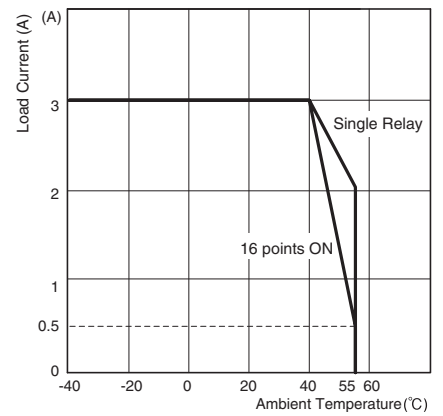

Inrush Current Resistance: Non-repetitive

The following graphs show the maximum inrush currents that can be withstood for non-repetitive operation. For repetitive operation, the figures should be reduced by half.

G3RV-202S DC24

G3RV-202SL DC24

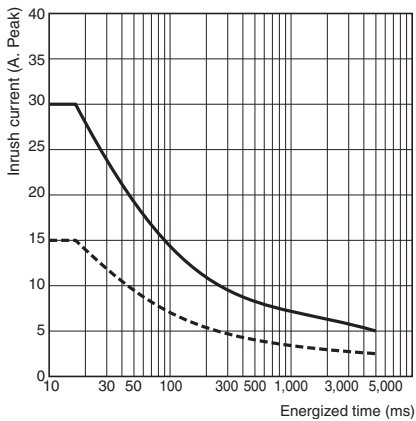

G3RV-D03 DC24

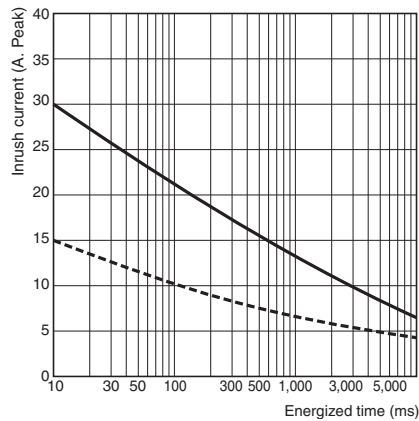

G70V

Internal Circuits

G70V-SID16P

(NPN input/- common)

Connector Pin Configuration Top View

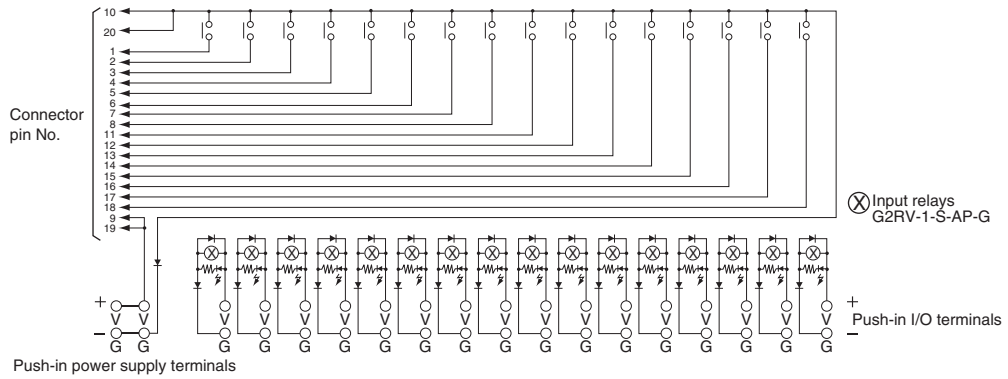
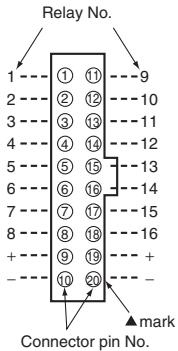

Note: Pin numbers are indicated for convenience. The ▲ mark can be used to determine orientation.

Terminal name	Description
V (push-in power supply terminals)	Unit power supply terminals (24 VDC)
G (push-in power supply terminals)	
V (push-in I/O terminals)	Relay-drive coil terminals (24 VDC)
G (push-in I/O terminals)	

G70V-SID16P-1

(PNP input/+ common)

Connector Pin Configuration Top View

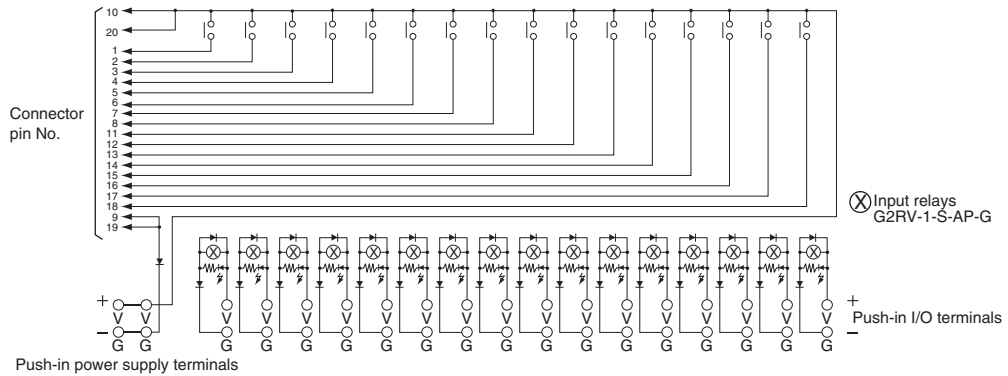
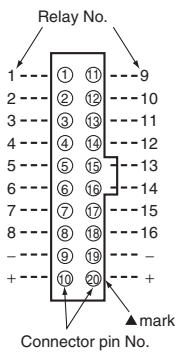

Note: Pin numbers are indicated for convenience. The ▲ mark can be used to determine orientation.

Terminal name	Description
V (push-in power supply terminals)	Unit power supply terminals (24 VDC)
G (push-in power supply terminals)	
V (push-in I/O terminals)	Relay-drive coil terminals (24 VDC)
G (push-in I/O terminals)	

G70V-SID16P-C16
(NPN input/– common)

Connector Pin Configuration Top View

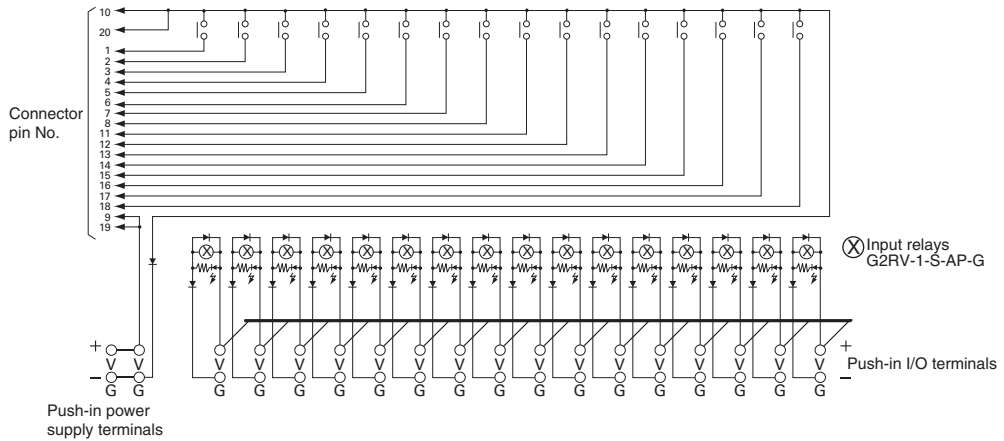
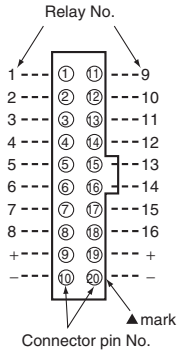

Note: Pin numbers are indicated for convenience. The ▲ mark can be used to determine orientation.

Terminal name	Description
V (push-in power supply terminals)	Unit power supply terminals (24 VDC)
G (push-in power supply terminals)	
V (push-in I/O terminals)	Relay-drive coil terminals (24 VDC)
G (push-in I/O terminals)	

G70V-SID16P-1-C16
(PNP input/+ common)

Connector Pin Configuration Top View

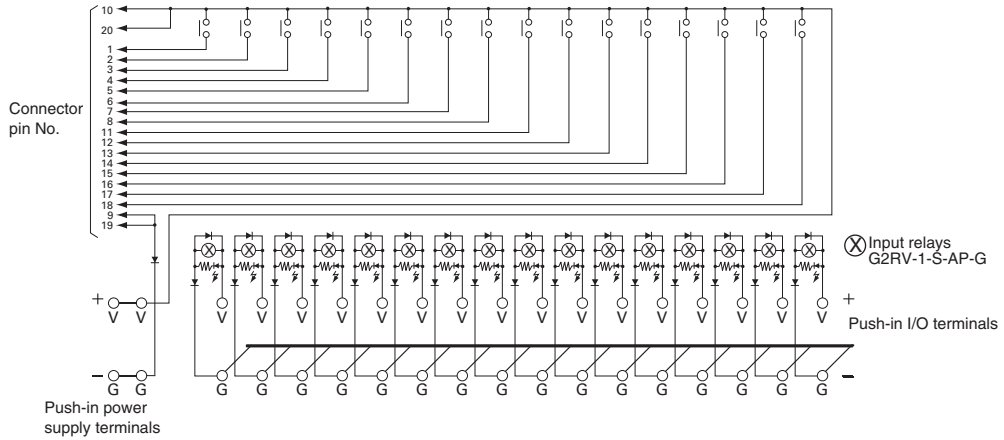
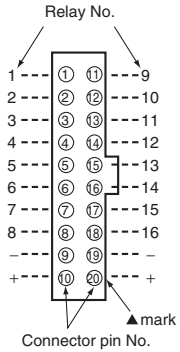

Note: Pin numbers are indicated for convenience. The ▲ mark can be used to determine orientation.

Terminal name	Description
V (push-in power supply terminals)	Unit power supply terminals (24 VDC)
G (push-in power supply terminals)	
V (push-in I/O terminals)	Relay-drive coil terminals (24 VDC)
G (push-in I/O terminals)	

G70V-SOC16P

(NPN output/+ common)

Note: A controller with an NPN transistor, common output can be connected to the G70V-SOC16P.

Connector Pin Configuration Top View

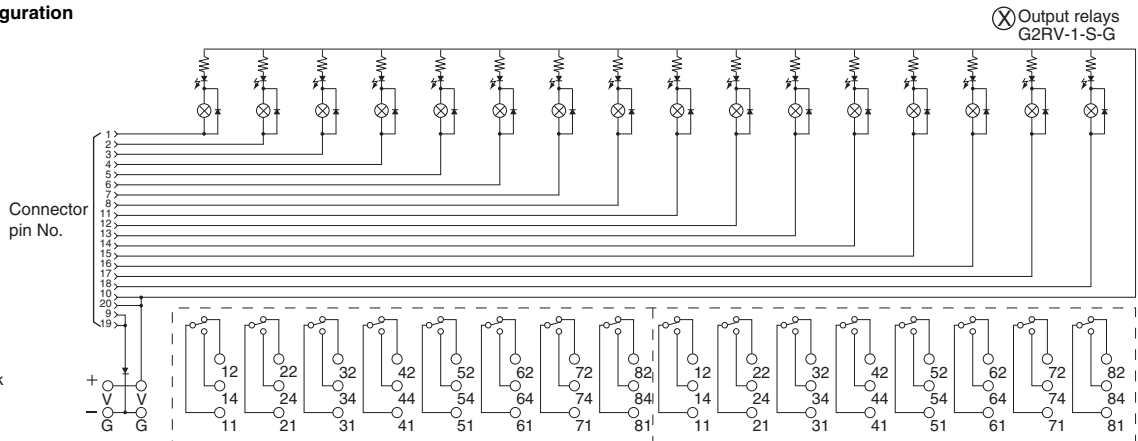
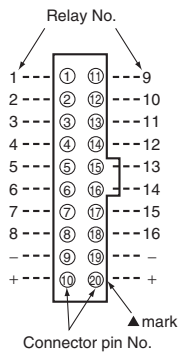

Note: Pin numbers are indicated for convenience. The ▲ mark can be used to determine orientation.

Terminal name	Description
V (push-in power supply terminals)	Unit power supply terminals (24 VDC)
G (push-in power supply terminals)	
11 to 81 (push-in I/O terminal common terminals)	Relay contact terminals
12 to 82 (push-in I/O terminal NC terminals)	
14 to 84 (push-in I/O terminal NO terminals)	

G70V-SOC16P-1

(PNP output/- common)

Note: A controller with a PNP transistor, + common output can be connected to the G70V-SOC16P-1.

Connector Pin Configuration Top View

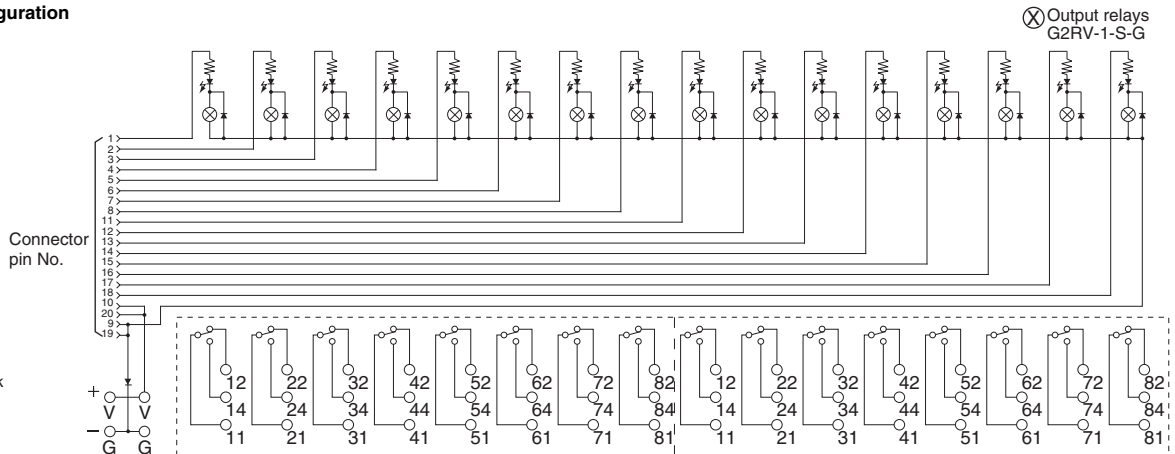
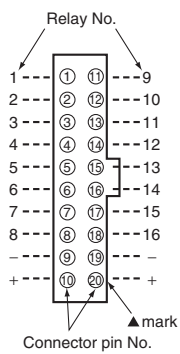

Note: Pin numbers are indicated for convenience. The ▲ mark can be used to determine orientation.

Terminal name	Description
V (push-in power supply terminals)	Unit power supply terminals (24 VDC)
G (push-in power supply terminals)	
11 to 81 (push-in I/O terminal common terminals)	Relay contact terminals
12 to 82 (push-in I/O terminal NC terminals)	
14 to 84 (push-in I/O terminal NO terminals)	

G70V-SOC16P-C4
(NPN output/+ common)

Note: A controller with an NPN transistor, common output can be connected to the G70V-SOC16P-C4.

Connector Pin Configuration
Top View

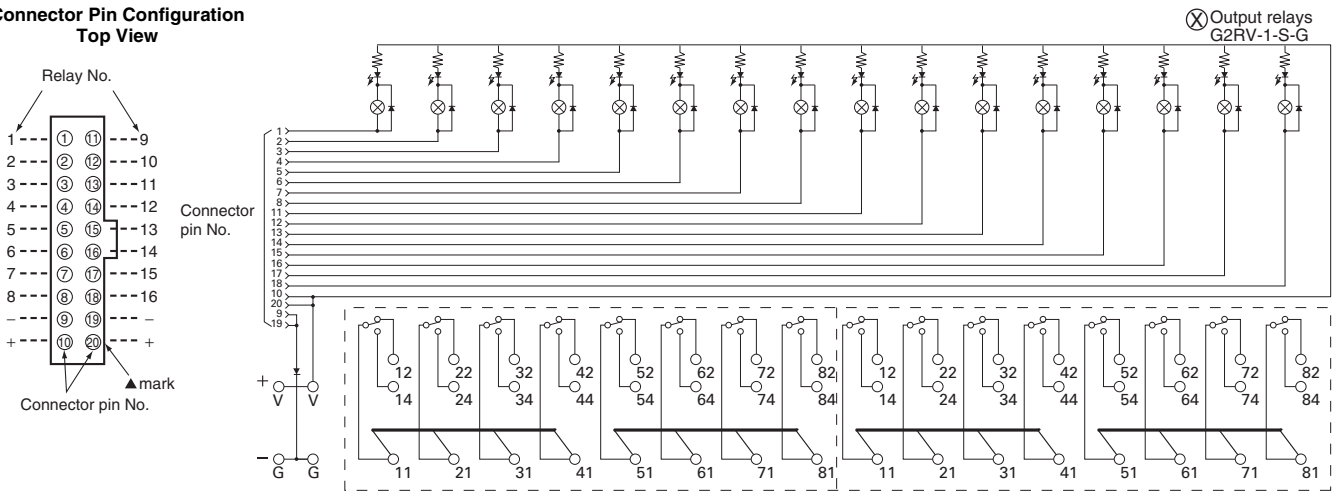

Note: Pin numbers are indicated for convenience. The ▲ mark can be used to determine orientation.

Terminal name	Description
V (push-in power supply terminals)	Unit power supply terminals (24 VDC)
G (push-in power supply terminals)	
11 to 81 (push-in I/O terminal common terminals)	Relay contact terminals
12 to 82 (push-in I/O terminal NC terminals)	
14 to 84 (push-in I/O terminal NO terminals)	

G70V-SOC16P-1-C4
(PNP output/- common)

Note: A controller with a PNP transistor, + common output can be connected to the G70V-SOC16P-1-C4.

Connector Pin Configuration
Top View

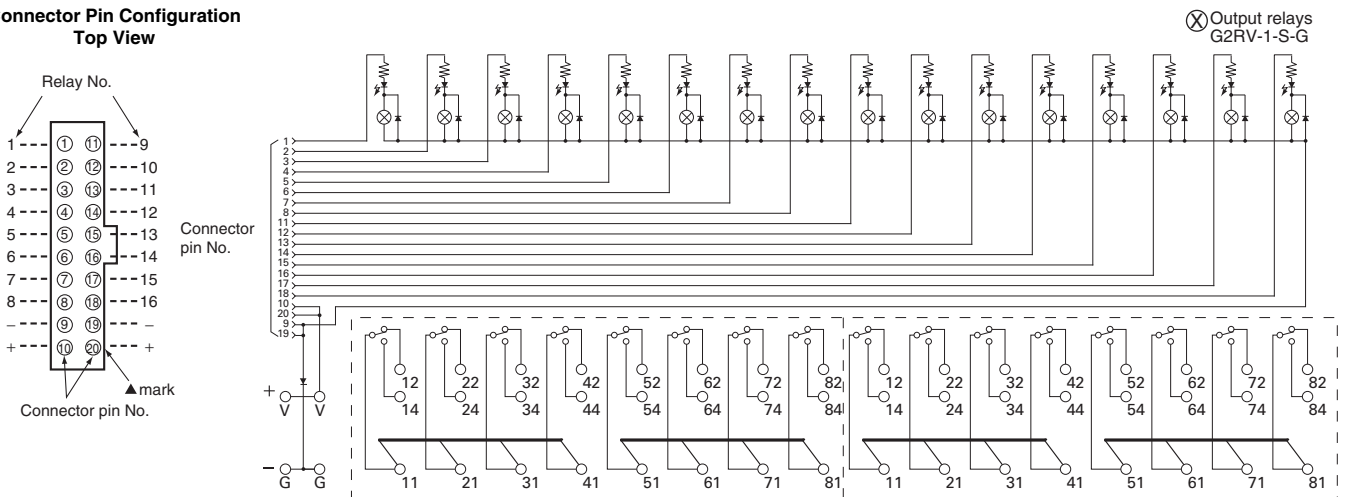

Note: Pin numbers are indicated for convenience. The ▲ mark can be used to determine orientation.

Terminal name	Description
V (push-in power supply terminals)	Unit power supply terminals (24 VDC)
G (push-in power supply terminals)	
11 to 81 (push-in I/O terminal common terminals)	Relay contact terminals
12 to 82 (push-in I/O terminal NC terminals)	
14 to 84 (push-in I/O terminal NO terminals)	

G70V-ZOM16P-1-C4-D (PNP output/- common)

Note: A controller with an PNP transistor, common output can be connected to the G70V-ZOM16P-1-C4-D.

Connector Pin Configuration Top View

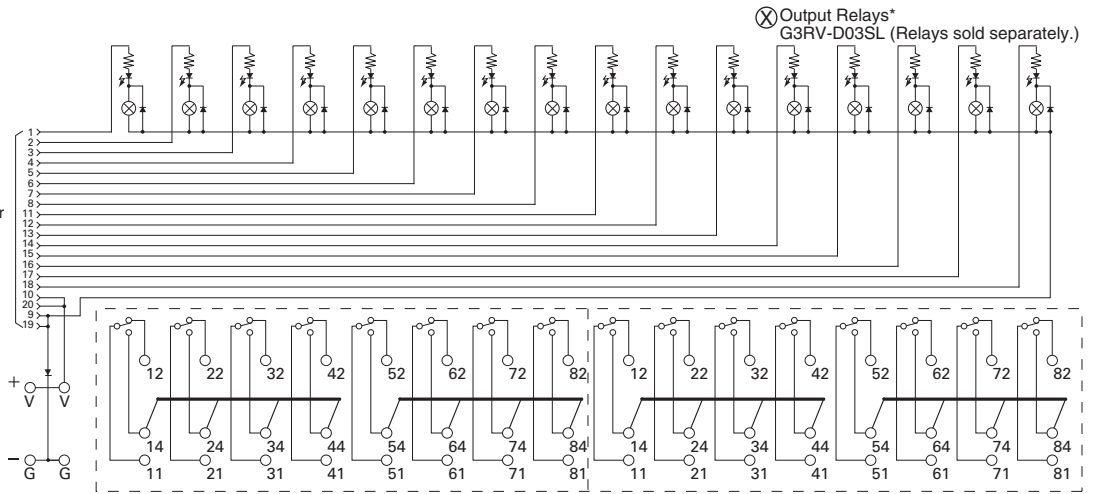
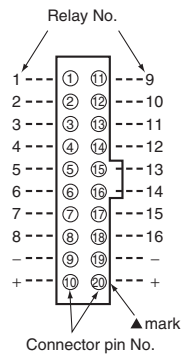

Note: Pin numbers are indicated for convenience. The ▲ mark can be used to determine orientation.

Terminal name	Description
V (push-in power supply terminals)	Unit power supply terminals (24 VDC)
G (push-in power supply terminals)	
11 to 81 (push-in I/O terminal SSR output terminal +)	SSR contact terminals
12 to 82 (push-in I/O terminal Open terminal)	
14 to 84 (push-in I/O terminal SSR output terminal -)	

* The G70V-ZOM16P-1-C4-D does not come with SSRs. Use Slim I/O SSRs (for DC: G3RV-D03SL).

Dimensions

I/O Relay Terminals and I/O Terminal Sockets

For Inputs

- G70V-SID16P
- G70V-SID16P-1
- G70V-ZID16P
- G70V-ZID16P-1
- G70V-SID16P-C16
- G70V-SID16P-1-C16
- G70V-ZID16P-C16
- G70V-ZID16P-1-C16

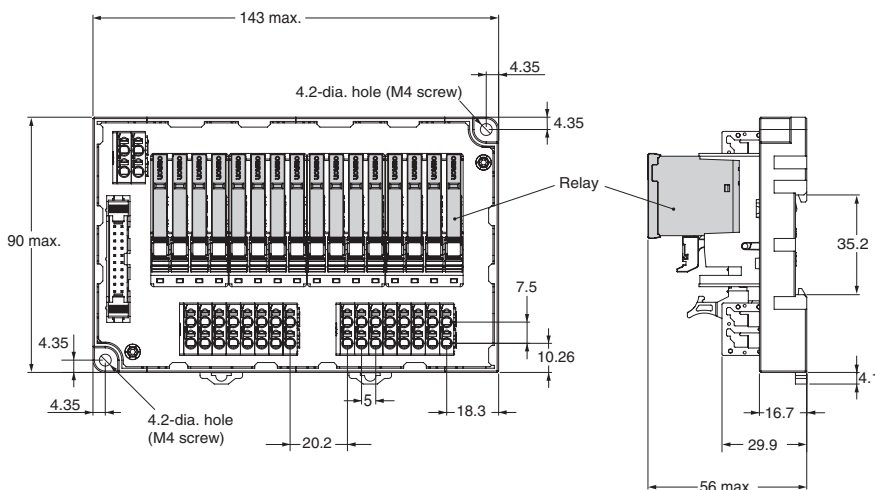
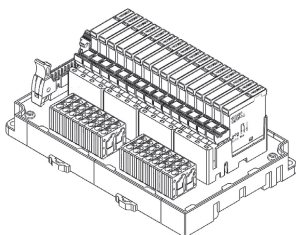

- Note:** 1. Relays are not mounted to the G70V-ZID16P(-1)(-C16) I/O Terminal Sockets. The dimensions are for when Relays are not mounted.
 2. Specified mounting torque: 0.59 to 0.98 N·m.

For Outputs

- G70V-SOC16P
- G70V-SOC16P-1
- G70V-ZOM16P
- G70V-ZOM16P-1
- G70V-SOC16P-C4
- G70V-SOC16P-1-C4
- G70V-ZOM16P-C4
- G70V-ZOM16P-1-C4
- G70V-ZOM16P-1-C4-D

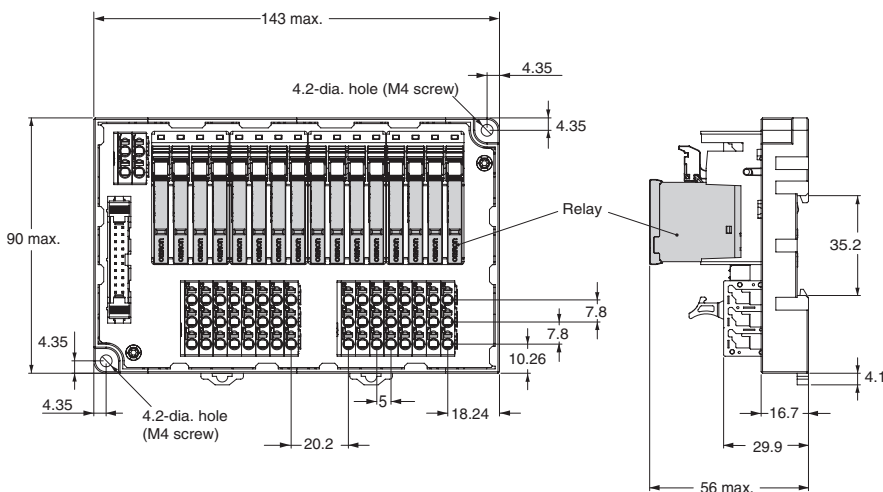
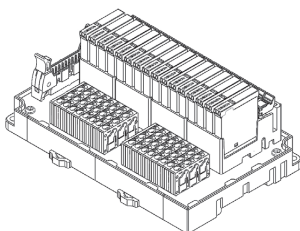

- Note:** 1. Relays are not mounted to the G70V-ZOM16P(-1)(-C4)(-D) I/O Terminal Sockets. The dimensions are for when Relays are not mounted.
 2. Specified mounting torque: 0.59 to 0.98 N·m.

G70V

Terminal Arrangement/Internal Connection

For Inputs

G70V-SID16P
G70V-SID16P-1

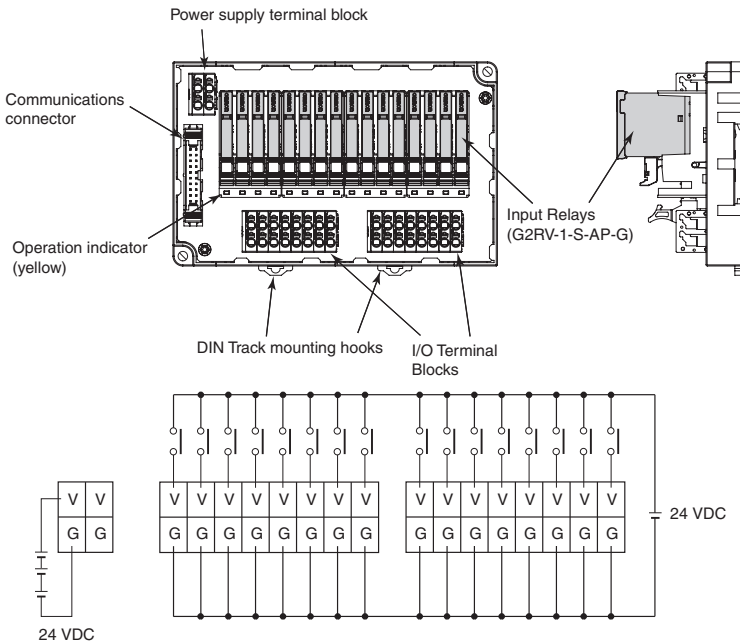

- Supply a power supply that meets the voltage specifications for both the Relays and I/O Relay Terminal to the V and G terminals. Make sure that the polarity is correct. The V terminals are positive and the G terminals are negative.
- Supply the rated voltage (24 VDC) of the Controller's input circuit to the power supply input terminals (V and G). Use a power supply with low noise.

For Outputs

G70V-SOC16P
G70V-SOC16P-1

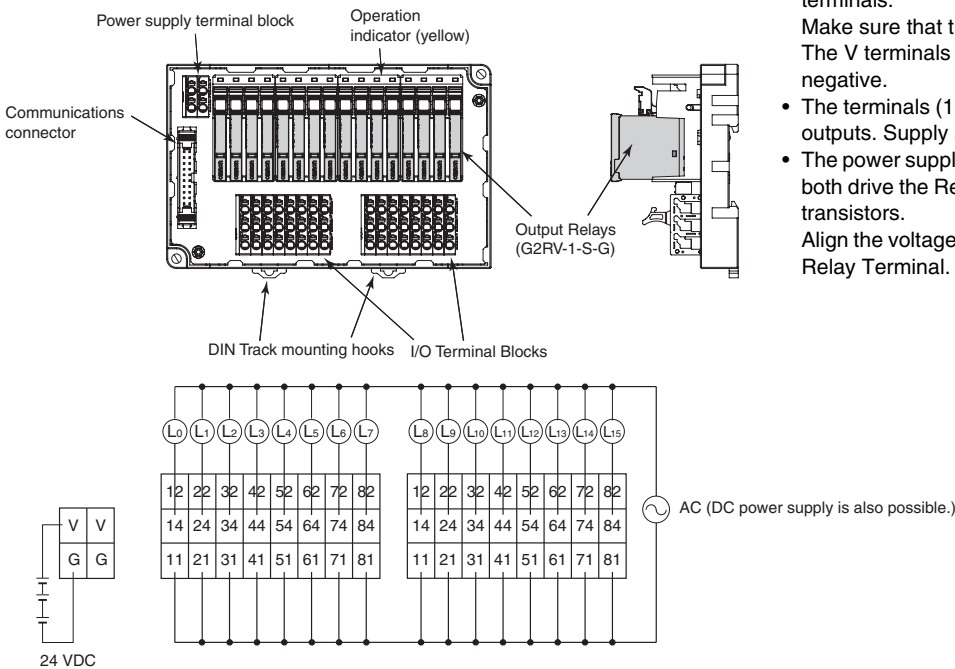

- Supply a power supply that meets the voltage specifications for both the Relays and I/O Relay Terminal to the V and G terminals. Make sure that the polarity is correct. The V terminals are positive and the G terminals are negative.
- The terminals (11 to 81, 12 to 82, and 14 to 84) are contact outputs. Supply a suitable power supply for the loads.
- The power supply input terminals (V and G) supply power to both drive the Relays and to operate the Controller's output transistors. Align the voltage specifications of the Controller and the I/O Relay Terminal.

For Inputs

G70V-SID16P-C16
G70V-SID16P-1-C16

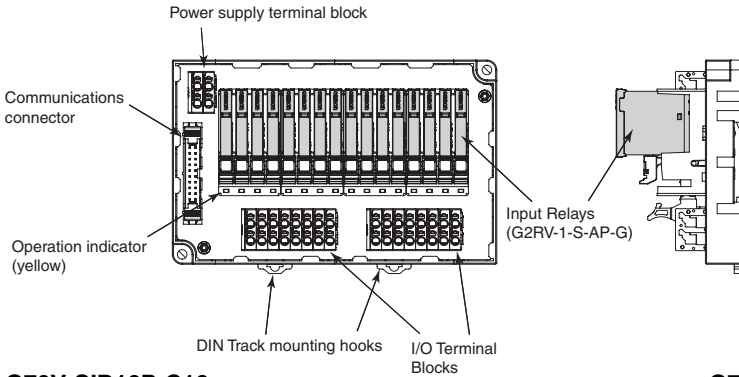

- Supply a power supply that meets the voltage specifications for both the Relays and I/O Relay Terminal to the V and G terminals. Make sure that the polarity is correct. The V terminals are positive and the G terminals are negative.
- Supply the rated voltage (24 VDC) of the Controller's input circuit to the power supply input terminals (V and G). Use a power supply with low noise.

G70V-SID16P-C16

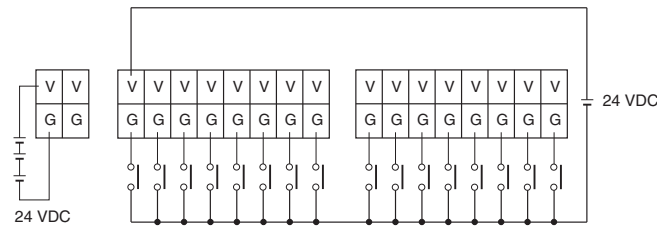

G70V-SID16P-1-C16

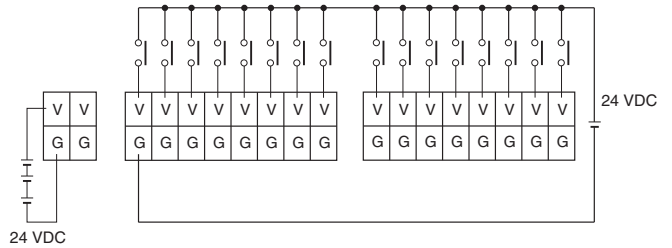

For Outputs

G70V-SOC16P-C4
G70V-SOC16P-1-C4

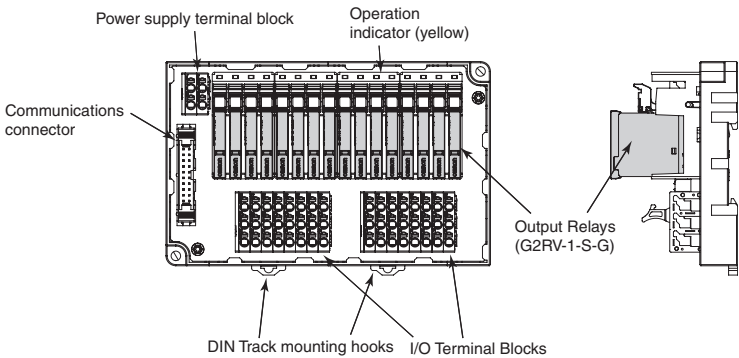

- Supply a power supply that meets the voltage specifications for both the Relays and I/O Relay Terminal to the V and G terminals. Make sure that the polarity is correct. The V terminals are positive and the G terminals are negative.
- The terminals (11 to 81, 12 to 82, and 14 to 84) are contact outputs. Supply a suitable power supply for the loads.
- The power supply input terminals (V and G) supply power to both drive the Relays and to operate the Controller's output transistors. Align the voltage specifications of the Controller and the I/O Relay Terminal.

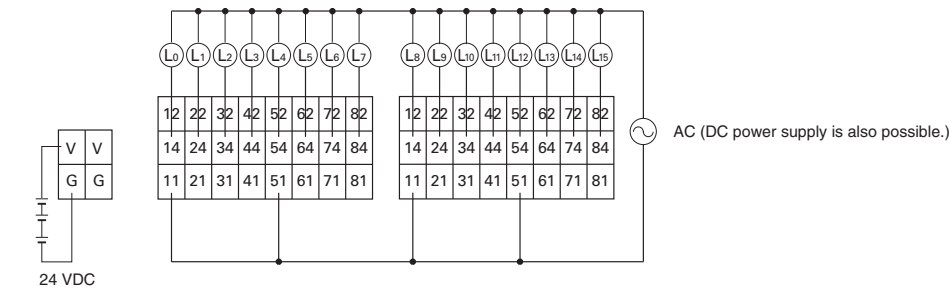

For Outputs

G70V-ZOM16P-1-C4-D

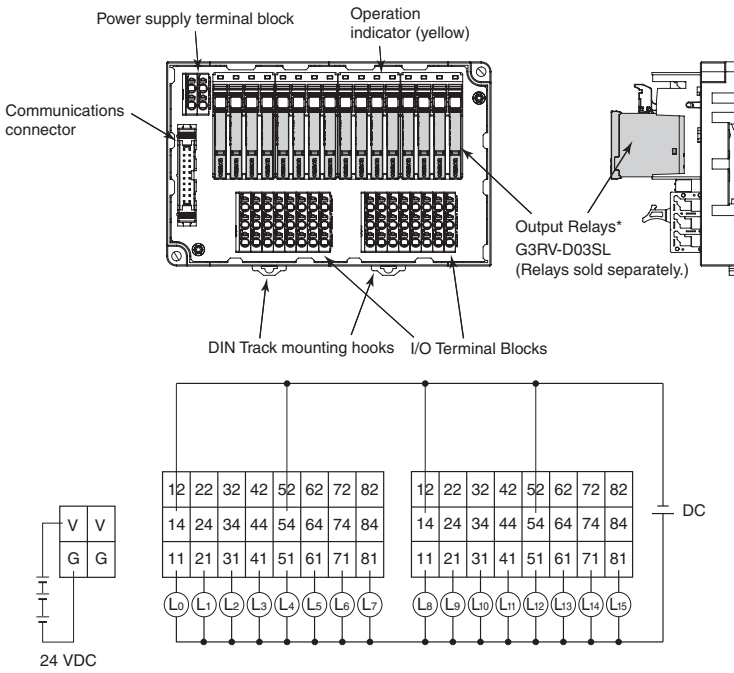

- Supply a power supply that meets the voltage specifications for both the Relays and I/O Relay Terminal to the V and G terminals.
Make sure that the polarity is correct.
The V terminals are positive and the G terminals are negative.
- The terminals (11 to 81 and 14 to 84) are contact outputs. Supply a suitable power supply for the loads. Make sure that polarity of the output terminal is correct.
- The power supply input terminals (V and G) supply power to both drive the Relays and to operate the Controller's output transistors.
Align the voltage specifications of the Controller and the I/O Relay Terminal.

* The G70V-ZOM16P-1-C4-D does not come with SSRs. Use Slim I/O SSRs (for DC: G3RV-D03SL).

Safety Precautions

Be sure to read *The Safety Precautions for All I/O Relay Terminals* in the website at the following URL:
<http://www.ia.omron.com/>.

Warning Indications

Precautions for Safe Use	Supplementary comments on what to do or avoid doing, to use the product safely.
Precautions for Correct Use	Supplementary comments on what to do or avoid doing, to prevent failure to operate, malfunction, or undesirable effects on product performance.

Precautions for Safe Use

Transportation

- Do not transport the I/O Relay Terminal under the following locations. Doing so may occasionally result in damage, malfunction, or deterioration of performance characteristics.
 - Locations subject to water or oil
 - Locations subject to high temperature or high humidity
 - Locations subject to condensation due to rapid changes in temperature

Operating and Storage Environments

- Do not use or store the I/O Relay Terminal in the following locations. Doing so may result in damage, malfunction, or deterioration of performance characteristics.
 - Locations subject to rainwater or water splashes
 - Locations subject to exposure to water, oil, or chemicals
 - Locations subject to high temperature or high humidity
 - Locations subject to ambient storage temperatures outside the range -40 to 65°C
 - Locations subject to ambient operating temperatures outside the range -40 to 55°C
 - Locations subject to relative humidity outside the range 35% to 85% or locations in which condensation may occur due to rapid changes in temperature
 - Locations subject to corrosive gases or inflammable gases
 - Locations subject to dust, salts, or iron, or locations where there is salt damage
 - Locations subject to direct sunlight
 - Locations subject to shock or vibration

Installation and Mounting

- Mount the I/O Relay Terminal in the specified direction. Otherwise excessive heat generated by the I/O Relay Terminal may occasionally cause burning.
- Mount the I/O Relay Terminal firmly to a DIN Track. Otherwise, the I/O Relay Terminal may fall off.
- Do not handle the I/O Relay Terminal with oily or dusty (especially iron dust) hands.
- Make sure that there is no excessive ambient temperature rise due to the heat generation of the I/O Relay Terminal. If the I/O Relay Terminal is mounted inside a panel, install a fan so that the interior of the panel is fully ventilated.

Installation and Wiring

- Use wires that are suited to the load current and voltage. Otherwise, excessive heat generated by the wires may cause burning or may cause the wire covering to melt, possibly leading to electric shock.
- Do not use wires with a damaged outer covering. Otherwise, it may result in electric shock or ground leakage.
- Do not wire any wiring in the same duct or conduit as power or high-tension lines. Otherwise, inductive noise may damage the I/O Relay Terminal or cause it to malfunction.
- Do not apply a voltage or current that exceeds the rating to any terminal. Doing so may result in failure or burning.

Push-In Plus Terminal Blocks

- Do not wire anything to the release holes.
- Do not tilt or twist a flat-blade screwdriver while it is inserted into a release hole on the terminal block. The terminal block may be damaged.
- Insert a flat-blade screwdriver into the release holes at an angle. The terminal block may be damaged if you insert the screwdriver straight in.
- Do not allow the flat-blade screwdriver to fall out while it is inserted into a release hole.
- Do not bend a wire past its natural bending radius or pull on it with excessive force. Doing so may cause the wire disconnection.
- Do not insert more than one wire into each terminal insertion hole.
- To prevent wire materials from smoking or igniting, confirm wire ratings and use the wiring materials given in the following table.

Recommended wire gauge	Stripping length (Ferrules not used)
0.25 to 1.5mm ² /AWG24 to 16	8 mm

- Refer to the following table for wire sizes for external I/O devices according to the current flow.

AWG24 to AWG20	Maximum current flow: 6 A
AWG18 to AWG16	Maximum current flow: 10 A

Application

- Select a load within the rated values. Not doing so may result in malfunction, failure, or burning.
- The I/O Relay Terminal may occasionally rupture if short-circuit current flows. As protection against accidents due to short-circuiting, be sure to install protective devices, such as fuses and no-fuse breakers, on the power supply side.
- Use a power supply within the rated frequencies. Otherwise, malfunction, failure, or burning may occasionally occur.
- Minor electric shock may occasionally occur. Always turn OFF the power supply before performing wiring.

Precautions for Correct Use

- Do not drop the I/O Relay Terminal or subject it to abnormal vibration or shock during transportation or mounting. Doing so may result in deterioration of performance, malfunction, or failure.
- Do not transport an I/O Relay Terminal when it is not packaged. Damage or failure may occur.
- Use a power supply with low noise.

Push-In Plus Terminal Blocks

1. Connecting Wires to the Push-In Plus Terminal Block Part Names of the Terminal Block

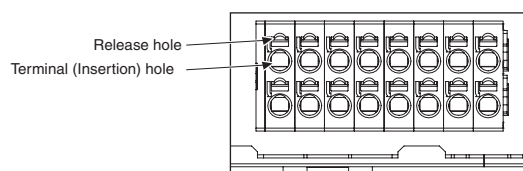

Connecting Wires with Ferrules and Solid Wires

Insert the solid wire or ferrule straight into the terminal block until the end strikes the terminal block.

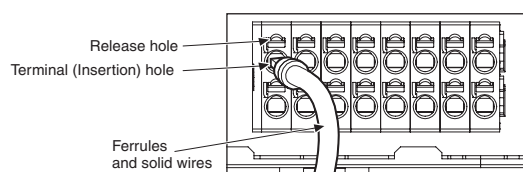

- If a wire is difficult to connect because it is too thin, use a flat-blade screwdriver in the same way as when connecting stranded wire.

Connecting Stranded Wires

Use the following procedure to connect the wires to the terminal block.

1. Hold a flat-blade screwdriver at an angle and insert it into the release hole.
The angle should be between 10° and 15°. If the flat-blade screwdriver is inserted correctly, you will feel the spring in the release hole.
2. With the flat-blade screwdriver still inserted into the release hole, insert the wire into the terminal hole until it strikes the terminal block.
3. Remove the flat-blade screwdriver from the release hole.

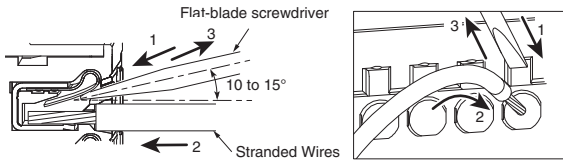

Checking Connections

- After the insertion, pull gently on the wire to make sure that it will not come off and the wire is securely fastened to the terminal block.
- If you use a ferrule with a conductor length of 10 mm, part of the conductor may be visible after the ferrule is inserted into the terminal block, but the product insulation distance will still be satisfied.

2. Removing Wires from the Push-In Plus Terminal Block

Use the following procedure to remove wires from the terminal block. The same method is used to remove stranded wires, solid wires, and ferrules.

1. Hold a flat-blade screwdriver at an angle and insert it into the release hole.
2. With the flat-blade screwdriver still inserted into the release hole, remove the wire from the terminal insertion hole.
3. Remove the flat-blade screwdriver from the release hole.

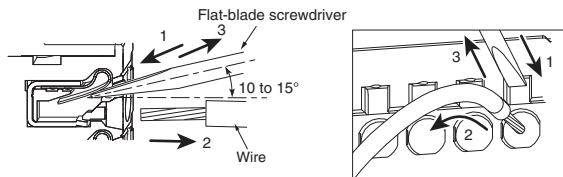

3. Recommended Ferrules and Crimp Tools

Recommended ferrules

Applicable wire		Ferrule Conductor length (mm)	Stripping length [mm] (Ferrules used)	Recommended ferrules		
(mm ²)	(AWG)			Phoenix Contact product	Weidmuller product	Wago product
0.25	24	8	10 AI0,25-8	H0.25/12	FE-0.25-8N-YE	
		10	12 AI0,25-10	---	---	
0.34	22	8	10 AI0,34-8	H0.34/12	FE-0.34-8N-TQ	
		10	12 AI0,34-10	---	---	
0.5	20	8	10 AI0,5-8	H0.5/14	FE-0.5-8N-WH	
		10	12 AI0,5-10	H0.5/16	FE-0.5-10N-WH	
0.75	18	8	10 AI0,75-8	H0.75/14	FE-0.75-8N-GY	
		10	12 AI0,75-10	H0.75/16	FE-0.75-10N-GY	
1/1.25	18/17	8	10 AI1-8	H1.0/14	FE-1.0-8N-RD	
		10	12 AI1-10	H1.0/16	FE-1.0-10N-RD	
1.25/1.5	17/16	8	10 AI1,5-8	H1.5/14	FE-1.5-8N-BK	
		10	12 AI1,5-10	H1.5/16	FE-1.5-10N-BK	
Recommended crimp tool				CRIMPFOX6 CRIMPFOX6T-F CRIMPFOX10S	PZ6 roto Variocrimp4	

- Note:**
1. Make sure that the outer diameter of the wire coating is smaller than the inner diameter of the insulation sleeve of the recommended ferrule.
 2. Make sure that the ferrule processing dimensions conform to the following figures.

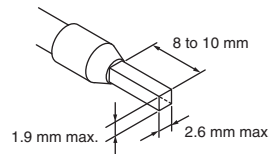

Recommended Flat-blade Screwdriver

Use a flat-blade screwdriver to connect and remove wires.

Use the following flat-blade screwdriver.

The following table shows manufacturers and models as of 2015/Dec.

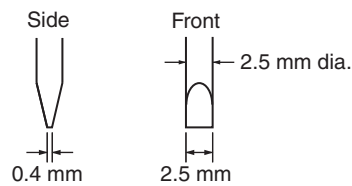

Model	Manufacturer
ESD0.40x2.5	Wera
SZS 0.4x2.5 SZF 0-0.4x2.5 *	Phoenix Contact
0.4x2.5x75 302	Wiha
AEF.2.5x75	Facom
210-719	Wago
SDI 0.4x2.5x75	Weidmuller

* OMRON's exclusive purchase model XW4Z-00B is available to order as SZF 0-0.4 x 2.5 (manufactured by Phoenix Contact).

Connecting Cables

Refer to the datasheet for the **XW2Z-R** Cables for I/O Relay Terminals

Type	Name	I/O Classification	Appearance	Cable length L (mm)			Models					
Various devices	Cables with Loose Wires and Crimp Terminals XW2Z-RY□C	16 I/O points		1,000			XW2Z-RY100C					
				1,500			XW2Z-RY150C					
				2,000			XW2Z-RY200C					
				3,000			XW2Z-RY300C					
				5,000			XW2Z-RY500C					
	Cables with Loose Wires XW2Z-RA□C	16 I/O points		2,000			XW2Z-RA200C					
5,000				XW2Z-RA500C								
Fujitsu connectors (24 pins)	Cables with Connectors (1:1) XW2Z-R□C	16 I/O points		1,000			XW2Z-R100C					
				1,500			XW2Z-R150C					
				2,000			XW2Z-R200C					
				3,000			XW2Z-R300C					
				5,000			XW2Z-R500C					
Fujitsu connectors (40 pins)	Cables with Connectors (1:2) XW2Z-RI□C-□ XW2Z-RO□C-□	32 input points		(A) 1,000	(B) 750	XW2Z-RI100C-75 XW2Z-RI150C-125 XW2Z-RI200C-175 XW2Z-RI300C-275 XW2Z-RI500C-475						
				(A) 1,500	(B) 1,250							
				(A) 2,000	(B) 1,750							
				(A) 3,000	(B) 2,750							
				(A) 5,000	(B) 4,750							
				32 output points	(A) 1,000		(B) 750	XW2Z-RO100C-75 XW2Z-RO150C-125 XW2Z-RO200C-175 XW2Z-RO300C-275 XW2Z-RO500C-475				
	(A) 1,500	(B) 1,250										
	(A) 2,000	(B) 1,750										
	(A) 3,000	(B) 2,750										
	(A) 5,000	(B) 4,750										
	Straight length (without bends)											
	Fujitsu connectors (56 pins)	Cables with Connectors (1:3) XW2Z-R□C-□-□	48 I/O points		(A) 1,500	(B) 1,250	(C) 1,000	XW2Z-R150C-125-100 XW2Z-R200C-175-150 XW2Z-R300C-275-250				
(A) 2,000					(B) 1,750	(C) 1,500						
(A) 3,000					(B) 2,750	(C) 2,500						
Straight length (without bends)												
MIL connectors (20 pins)					Cables with Connectors (1:1) XW2Z-RI□C XW2Z-RO□C	16 I/O points			250			XW2Z-RI25C
									500			XW2Z-RI50C
	250			XW2Z-RO25C								
	500			XW2Z-RO50C								

Type	Name	I/O Classification	Appearance	Cable length L (mm)		Models
				(A)	(B)	
MIL connectors (40 pins)	Cables with Connectors (1:2) XW2Z-RO□-□-D1, XW2Z-RI□-□-D1, XW2Z-RI□-□-D2, XW2Z-RM□-□-D1*, XW2Z-RM□-□-D2*	32 I/O points		(A) 500	(B) 250	XW2Z-RO50-25-D1
				(A) 750	(B) 500	XW2Z-RO75-50-D1
				(A) 1,000	(B) 750	XW2Z-RO100-75-D1
				(A) 1,500	(B) 1,250	XW2Z-RO150-125-D1
				(A) 2,000	(B) 1,750	XW2Z-RO200-175-D1
				(A) 3,000	(B) 2,750	XW2Z-RO300-275-D1
				(A) 5,000	(B) 4,750	XW2Z-RO500-475-D1
				(A) 500	(B) 250	XW2Z-RI50-25-D1
				(A) 750	(B) 500	XW2Z-RI75-50-D1
				(A) 1,000	(B) 750	XW2Z-RI100-75-D1
		(A) 1,500	(B) 1,250	XW2Z-RI150-125-D1		
		(A) 2,000	(B) 1,750	XW2Z-RI200-175-D1		
		(A) 3,000	(B) 2,750	XW2Z-RI300-275-D1		
		(A) 5,000	(B) 4,750	XW2Z-RI500-475-D1		
		(A) 500	(B) 250	XW2Z-RI50-25-D2		
		(A) 750	(B) 500	XW2Z-RI75-50-D2		
		(A) 500	(B) 250	XW2Z-RM50-25-D1		
		(A) 750	(B) 500	XW2Z-RM75-50-D1		
		(A) 1,000	(B) 750	XW2Z-RM100-75-D1		
		(A) 1,500	(B) 1,250	XW2Z-RM150-125-D1		
(A) 2,000	(B) 1,750	XW2Z-RM200-175-D1				
(A) 3,000	(B) 2,750	XW2Z-RM300-275-D1				
(A) 5,000	(B) 4,750	XW2Z-RM500-475-D1				
(A) 500	(B) 250	XW2Z-RM50-25-D2				
(A) 750	(B) 500	XW2Z-RM75-50-D2				
Mitsubishi Electric PLCs with 32-point connectors (1:2)	Mitsubishi Electric PLC Connecting Cables XW2Z-RI□C-□-MN XW2Z-RO□C-□-MN	32 input points		(A) 1,000	(B) 750	XW2Z-RI100C-75-MN
				(A) 1,500	(B) 1,250	XW2Z-RI150C-125-MN
				(A) 2,000	(B) 1,750	XW2Z-RI200C-175-MN
				(A) 3,000	(B) 2,750	XW2Z-RI300C-275-MN
				(A) 1,000	(B) 750	XW2Z-RO100C-75-MN
		32 output points		(A) 1,500	(B) 1,250	XW2Z-RO150C-125-MN
				(A) 2,000	(B) 1,750	XW2Z-RO200C-175-MN
				(A) 3,000	(B) 2,750	XW2Z-RO300C-275-MN
				(A) 500	(B) 250	XW2Z-RM50-25-D2
				(A) 750	(B) 500	XW2Z-RM75-50-D2
Schneider Electric PLCs with 32-point connectors (1:2)	Schneider Electric PLC Connecting Cables	32 input points		500		XW2Z-R050C-SCH-A
				1,000		XW2Z-R100C-SCH-A
				2,000		XW2Z-R200C-SCH-A
				3,000		XW2Z-R300C-SCH-A
				5,000		XW2Z-R500C-SCH-A
		32 output points		500		XW2Z-R050C-SCH-B
				1,000		XW2Z-R100C-SCH-B
				2,000		XW2Z-R200C-SCH-B
				3,000		XW2Z-R300C-SCH-B
				5,000		XW2Z-R500C-SCH-B
Schneider Electric PLCs with 16-point connectors (1:1)	XW2Z-R□C-SCH-□	16 input points		500		XW2Z-R050C-SCH-C
				1,000		XW2Z-R100C-SCH-C
				2,000		XW2Z-R200C-SCH-C
				3,000		XW2Z-R300C-SCH-C
				5,000		XW2Z-R500C-SCH-C
		16 output points		500		XW2Z-R050C-SCH-D
				1,000		XW2Z-R100C-SCH-D
				2,000		XW2Z-R200C-SCH-D
				3,000		XW2Z-R300C-SCH-D
				5,000		XW2Z-R500C-SCH-D

* These cables are used to connect to slave products for DeviceNet and other networks.

Type	Name	I/O Classification	Appearance	Cable length L (mm)	Models
Siemens PLCs with 32-point connectors (1:2) Applicable models: For inputs: 6ES7 321-1BL00-0AA0 For outputs: 6ES7 322-1BL00-0AA0		32 input points		500	XW2Z-R050C-SIM-A
				1,000	XW2Z-R100C-SIM-A
				2,000	XW2Z-R200C-SIM-A
				3,000	XW2Z-R300C-SIM-A
				5,000	XW2Z-R500C-SIM-A
		32 output points		500	XW2Z-R050C-SIM-B
				1,000	XW2Z-R100C-SIM-B
				2,000	XW2Z-R200C-SIM-B
				3,000	XW2Z-R300C-SIM-B
				5,000	XW2Z-R500C-SIM-B
Siemens PLCs with 16-point connectors (1:1) Applicable models: For inputs: 6ES7 321-1BH02-0AA0	Siemens PLC Connecting Cables XW2Z-R□C-SIM-□	16 input points		500	XW2Z-R050C-SIM-C
				1,000	XW2Z-R100C-SIM-C
				2,000	XW2Z-R200C-SIM-C
				3,000	XW2Z-R300C-SIM-C
				5,000	XW2Z-R500C-SIM-C
Siemens PLCs with 32-point connectors (1:2) Applicable models: For inputs: 6ES7 421-1BL-0AA0 For outputs: 6ES7 422-1BL-0AA0		32 input points		500	XW2Z-R050C-SIM-D
				1,000	XW2Z-R100C-SIM-D
				2,000	XW2Z-R200C-SIM-D
				3,000	XW2Z-R300C-SIM-D
				5,000	XW2Z-R500C-SIM-D
		32 output points		500	XW2Z-R050C-SIM-E
				1,000	XW2Z-R100C-SIM-E
				2,000	XW2Z-R200C-SIM-E
				3,000	XW2Z-R300C-SIM-E
				5,000	XW2Z-R500C-SIM-E

Note: 1. Refer to Combinations of Connections starting on the next page.
 2. For connector pin diagrams and cable colors, refer to the wiring diagrams starting on page 4 of *XW2Z-R Cables for I/O Relay Terminals*.

Combinations of Connections

Refer to Combinations of Connections (PLC I/O Units, NX Series, CJ Series, and CS Series) starting on the next page.
 For combinations with other products, refer to *I/O Relay Terminals and Connected Devices* (Cat. No. J217) or to the datasheets for related products.

Connection Patterns

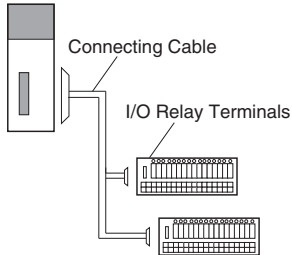
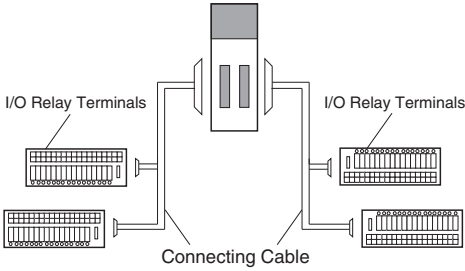
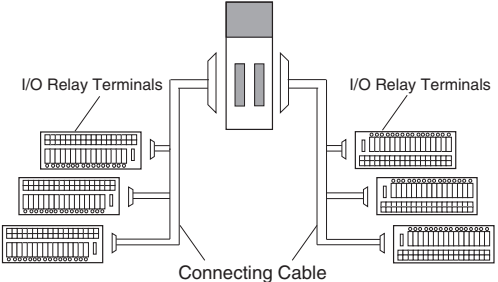
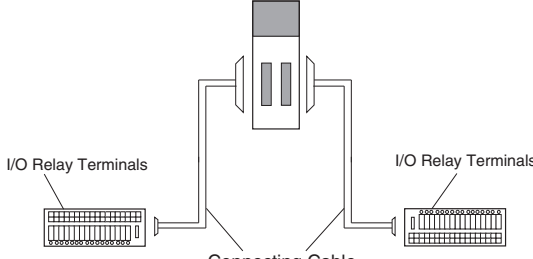
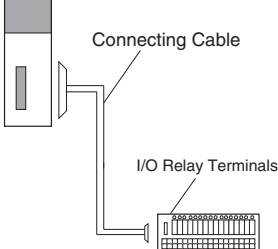
Pattern	Configuration
A	
B	
D	
E	
F	

Combinations with NX Series

NX I/O Units				Conne ction pattern	XW2Z-R Cables			G70V I/O Relay Terminals		
I/O capacity	Model	External connectors	Polarity		Specifications	Model *1	Quantity required	Specifications	Model	Quantity required
Input Units										
16 inputs	NX-ID5142-5	1 MIL connector	NPN or PNP	F	1:1 for 16 inputs	XW2Z-RO□C	1	Inputs *2	G70V-SID16P(-1)(-C16)	1
32 inputs	NX-ID6142-5	1 MIL connector	NPN or PNP	A	1:2 for 32 inputs	XW2Z-RO□□-D1	1		G70V-SID16P(-1)(-C16)	2
	NX-ID6142-6	1 Fujitsu connector	NPN or PNP		1:2 for 32 inputs	XW2Z-RI□C-□	1		G70V-SID16P(-1)(-C16)	2
Output Units										
16 outputs	NX-OD5121-5	1 MIL connector	NPN	F	1:1 for 16 outputs	XW2Z-RO□C	1	NPN outputs	G70V-SOC16P(-C4)	1
	NX-OD5256-5	1 MIL connector	PNP		1:1 for 16 outputs	XW2Z-RO□C	1	PNP outputs	G70V-SOC16P-1(-C4)	1
32 outputs	NX-OD6121-5	1 MIL connector	NPN	A	1:2 for 32 outputs	XW2Z-RO□□-D1	1	NPN outputs	G70V-SOC16P(-C4)	2
	NX-OD6256-5	1 MIL connector	PNP		1:2 for 32 outputs	XW2Z-RO□□-D1	1	PNP outputs	G70V-SOC16P-1(-C4)	2
32 outputs	NX-OD6121-6	1 Fujitsu connector	NPN		1:2 for 32 outputs	XW2Z-RO□C-□	1	NPN outputs	G70V-SOC16P(-C4)	2
Mixed I/O Units										
16 inputs and 16 outputs	NX-MD6121-6	2 Fujitsu connectors (1 for 16 inputs and 1 for 16 outputs)	Outputs: NPN Inputs: NPN or PNP	E	1:1 for 16 inputs or outputs	XW2Z-R□C	2	Inputs *2	G70V-SID16P(-1)(-C16)	1
								NPN outputs	G70V-SOC16P(-C4)	1
	NX-MD6121-5	2 MIL connectors (1 for 16 inputs and 1 for 16 outputs)	Outputs: NPN Inputs: NPN or PNP		1:1 for 16 inputs	XW2Z-RO□C	1	Inputs *2	G70V-SID16P(-1)(-C16)	1
					1:1 for 16 outputs	XW2Z-RO□C	1	NPN outputs	G70V-SOC16P(-C4)	1
					1:1 for 16 inputs	XW2Z-RO□C	1	Inputs *2	G70V-SID16P(-1)(-C16)	1
NX-MD6256-5	2 MIL connectors (1 for 16 inputs and 1 for 16 outputs)	Outputs: PNP Inputs: NPN or PNP	1:1 for 16 outputs	XW2Z-RI□C	1	PNP outputs	G70V-SOC16P-1(-C4)	1		

*1. The box □ is replaced by the cable length.

*2. Either NPN inputs or PNP inputs can be used.

Combinations with CJ Series

CJ1W I/O Units				Conne- tion pattern	XW2Z-R Cables			G70V I/O Relay Terminals		
I/O capacity	Model	External connectors	Polarity		Specifications	Model *1	Quantity required	Specifications	Model	Quantity required
DC Input Units										
32 inputs	CJ1W-ID231	1 Fujitsu connector	NPN	A	1:2 for 32 inputs	XW2Z-RI□C-□	1	Inputs *2	G70V-SID16P(-1)(-C16)	2
	CJ1W-ID232	1 MIL connector	NPN		1:2 for 32 inputs	XW2Z-RO□□-□D1	1			
	CJ1W-ID233	1 MIL connector	NPN		1:2 for 32 inputs	XW2Z-RO□□-□D1	1			
64 inputs	CJ1W-ID261	2 Fujitsu connectors (2, 32-point connectors)	NPN	B	1:2 for 32 inputs	XW2Z-RI□C-□	1		G70V-SID16P(-1)(-C16)	4
	CJ1W-ID262	2 MIL connectors (2, 32-point connectors)	NPN		1:2 for 32 inputs	XW2Z-RO□□-□D1	1			
Transistor Output Units										
32 outputs	CJ1W-OD231	1 Fujitsu connector	Sinking (NPN)	A	1:2 for 32 outputs	XW2Z-RO□□C-□	1	NPN outputs	G70V-SOC16P(-C4)	2
	CJ1W-OD233	1 MIL connector	Sinking (NPN)		1:2 for 32 outputs	XW2Z-RO□□-□D1	1			
	CJ1W-OD232	1 MIL connector	Sourcing (PNP)		1:2 for 32 outputs	XW2Z-RO□□-□D1	1	PNP outputs	G70V-SOC16P-1(-C4)	2
	CJ1W-OD234	1 MIL connector	Sinking (NPN)		1:2 for 32 outputs	XW2Z-RO□□-□D1	1	NPN outputs	G70V-SOC16P(-C4)	2
64 outputs	CJ1W-OD261	2 Fujitsu connectors (2, 32-point connectors)	Sinking (NPN)	B	1:2 for 32 outputs	XW2Z-RO□□C-□	2	NPN outputs	G70V-SOC16P(-C4)	4
	CJ1W-OD262	2 MIL connectors (2, 32-point connectors)	Sourcing (PNP)		1:2 for 32 outputs	XW2Z-RO□□-□D1	2	PNP outputs	G70V-SOC16P-1(-C4)	4
	CJ1W-OD263	2 MIL connectors (2, 32-point connectors)	Sinking (NPN)		1:2 for 32 outputs	XW2Z-RO□□-□D1	2	NPN outputs	G70V-SOC16P(-C4)	4
DC Input/Transistor Output Units										
16 inputs and 16 outputs	CJ1W-MD231	2 Fujitsu connectors (1 for 16 inputs and 1 for 16 outputs)	Sinking (NPN)	E	1:1 for 16 inputs or outputs	XW2Z-R□C	2	Inputs *2	G70V-SID16P(-1)(-C16)	1
			NPN outputs					G70V-SOC16P(-C4)	1	
	CJ1W-MD233	2 MIL connectors (1 for 16 inputs and 1 for 16 outputs)	Sinking (NPN)		1:1 for 16 inputs	XW2Z-RO□C	1	Inputs *2	G70V-SID16P(-1)(-C16)	1
					1:1 for 16 outputs	XW2Z-RO□C	1	NPN outputs	G70V-SOC16P(-C4)	1
	CJ1W-MD232	2 MIL connectors (1 for 16 inputs and 1 for 16 outputs)	Sourcing (PNP)		1:1 for 16 inputs	XW2Z-RO□C	1	Inputs *2	G70V-SID16P(-1)(-C16)	1
1:1 for 16 outputs				XW2Z-RI□C	1	PNP outputs	G70V-SOC16P-1(-C4)	1		
32 inputs and 32 outputs	CJ1W-MD261	2 Fujitsu connectors (1 for 32 inputs and 1 for 32 outputs)	Sinking (NPN)	B	1:2 for 16 inputs	XW2Z-RI□C-□	1	Inputs *2	G70V-SID16P(-1)(-C16)	2
					1:2 for 16 outputs	XW2Z-RO□□C-□	1	NPN outputs	G70V-SOC16P(-C4)	2
	CJ1W-MD263	2 MIL connectors (1 for 32 inputs and 1 for 32 outputs)	Sinking (NPN)		1:2 for 32 inputs	XW2Z-RO□□-□D1	1	Inputs *2	G70V-SID16P(-1)(-C16)	2
					1:2 for 32 outputs	XW2Z-RO□□-□D1	1	NPN outputs	G70V-SOC16P(-C4)	2

*1. The box □ is replaced by the cable length.

*2. Either NPN inputs or PNP inputs can be used.

Combinations with CS Series

CJ1W I/O Units				Conne ction pattern	XW2Z-R Cables			G70V I/O Relay Terminals		
I/O capacity	Model	External connectors	Polarity		Specifications	Model *1	Quantity required	Specifications	Model	Quantity required
DC Input Units										
32 inputs	CS1W-ID231	1 Fujitsu connector	NPN	A	1:2 for 32 inputs	XW2Z-RI□C-□	1	Inputs #2	G70V-SID16P(-1)(-C16)	2
64 inputs	CS1W-ID261	2 Fujitsu connectors (2, 32-point connectors)	NPN	B	1:2 for 32 inputs	XW2Z-RI□C-□	2		G70V-SID16P(-1)(-C16)	4
96 inputs	CS1W-ID291	2 Fujitsu connectors (2, 48-point connectors)	NPN	D	1:3 for 48 inputs or outputs	XW2Z-R□C-□-□	2		G70V-SID16P(-1)(-C16)	6
Transistor Output Units										
32 outputs	CS1W-OD231	1 Fujitsu connector	Sinking (NPN)	A	1:2 for 32 outputs	XW2Z-RO□C-□	1	NPN outputs	G70V-SOC16P(-C4)	2
	CS1W-OD232	1 Fujitsu connector	Sourcing (PNP)		1:2 for 32 outputs	XW2Z-RO□C-□	1	PNP outputs	G70V-SOC16P-1(-C4)	2
64 outputs	CS1W-OD261	2 Fujitsu connectors (2, 32-point connectors)	Sinking (NPN)	B	1:2 for 32 outputs	XW2Z-RO□C-□	2	NPN outputs	G70V-SOC16P(-C4)	4
	CS1W-OD262	2 Fujitsu connectors (2, 32-point connectors)	Sourcing (PNP)		1:2 for 32 outputs	XW2Z-RO□C-□	2	PNP outputs	G70V-SOC16P-1(-C4)	4
96 outputs	CS1W-OD291	2 Fujitsu connectors (2, 48-point connectors)	Sinking (NPN)	D	1:3 for 48 inputs or outputs	XW2Z-R□C-□-□	2	NPN outputs	G70V-SOC16P(-C4)	6
DC Input/Transistor Output Units										
32 inputs and 32 outputs	CS1W-MD261	2 Fujitsu connectors (1 for 32 inputs and 1 for 32 outputs)	Sinking (NPN)	B	1:2 for 32 inputs	XW2Z-RI□C-□	1	Inputs #2	G70V-SID16P(-1)(-C16)	2
					1:2 for 32 outputs	XW2Z-RO□C-□	1	NPN outputs	G70V-SOC16P(-C4)	2
	CS1W-MD262	2 Fujitsu connectors (1 for 32 inputs and 1 for 32 outputs)	Sourcing (PNP)		1:2 for 32 inputs	XW2Z-RI□C-□	1	Inputs #2	G70V-SID16P(-1)(-C16)	2
					1:2 for 32 outputs	XW2Z-RO□C-□	1	PNP outputs	G70V-SOC16P-1(-C4)	2
48 inputs and 48 outputs	CS1W-MD291	2 Fujitsu connectors (1 for 48 inputs and 1 for 48 outputs)	Sinking (NPN)	D	1:3 for 48 inputs or outputs	XW2Z-R□C-□-□	2	Inputs #2	G70V-SID16P(-1)(-C16)	3
								NPN outputs	G70V-SOC16P(-C4)	3
CS1W-MD292	2 Fujitsu connectors (1 for 48 inputs and 1 for 48 outputs)	Sourcing (PNP)	1:3 for 48 inputs or outputs		XW2Z-R□C-□-□	1	Inputs #2	G70V-SID16P(-1)(-C16)	3	

*1. The box □ is replaced by the cable length.

*2. Either NPN inputs or PNP inputs can be used.

Refer to the manuals for the connected PLC for the connections to I/O Units for OMRON PLCs.

Series	Model	Man. No.	Manual Name
CS1	CS1G-CPU□□H, CS1H-CPU□□H	W339	Programmable Controllers Operation Manual
CJ1	CJ1H-CPU□□H-R, CJ1G/H-CPU□□H, CJ1G-CPU□□P, CJ1M-CPU□□, CJ1G-CPU□□	W393	CJ Series Programmable Controllers Operation Manual
CJ2	CJ2H-CPU6□-EIP, CJ2H-CPU6□, CJ2M-CPU□□	W472	CJ-series CJ2 CPU Unit Hardware User's Manual
NJ	NJ501-□□□□	W500	NJ-series CPU Unit Hardware User's Manual
NX	NX-ID□□□□, NX-IA□□□□, NX-OD□□□□, NX-OC□□□□, NX-MD□□□□	W521	NX-series Digital I/O Units User's Manual

Terms and Conditions Agreement

Read and understand this catalog.

Please read and understand this catalog before purchasing the products. Please consult your OMRON representative if you have any questions or comments.

Warranties.

- (a) Exclusive Warranty. Omron's exclusive warranty is that the Products will be free from defects in materials and workmanship for a period of twelve months from the date of sale by Omron (or such other period expressed in writing by Omron). Omron disclaims all other warranties, express or implied.
- (b) Limitations. OMRON MAKES NO WARRANTY OR REPRESENTATION, EXPRESS OR IMPLIED, ABOUT NON-INFRINGEMENT, MERCHANTABILITY OR FITNESS FOR A PARTICULAR PURPOSE OF THE PRODUCTS. BUYER ACKNOWLEDGES THAT IT ALONE HAS DETERMINED THAT THE PRODUCTS WILL SUITABLY MEET THE REQUIREMENTS OF THEIR INTENDED USE.

Omron further disclaims all warranties and responsibility of any type for claims or expenses based on infringement by the Products or otherwise of any intellectual property right. (c) Buyer Remedy. Omron's sole obligation hereunder shall be, at Omron's election, to (i) replace (in the form originally shipped with Buyer responsible for labor charges for removal or replacement thereof) the non-complying Product, (ii) repair the non-complying Product, or (iii) repay or credit Buyer an amount equal to the purchase price of the non-complying Product; provided that in no event shall Omron be responsible for warranty, repair, indemnity or any other claims or expenses regarding the Products unless Omron's analysis confirms that the Products were properly handled, stored, installed and maintained and not subject to contamination, abuse, misuse or inappropriate modification. Return of any Products by Buyer must be approved in writing by Omron before shipment. Omron Companies shall not be liable for the suitability or unsuitability or the results from the use of Products in combination with any electrical or electronic components, circuits, system assemblies or any other materials or substances or environments. Any advice, recommendations or information given orally or in writing, are not to be construed as an amendment or addition to the above warranty.

See <http://www.omron.com/global/> or contact your Omron representative for published information.

Limitation on Liability; Etc.

OMRON COMPANIES SHALL NOT BE LIABLE FOR SPECIAL, INDIRECT, INCIDENTAL, OR CONSEQUENTIAL DAMAGES, LOSS OF PROFITS OR PRODUCTION OR COMMERCIAL LOSS IN ANY WAY CONNECTED WITH THE PRODUCTS, WHETHER SUCH CLAIM IS BASED IN CONTRACT, WARRANTY, NEGLIGENCE OR STRICT LIABILITY.

Further, in no event shall liability of Omron Companies exceed the individual price of the Product on which liability is asserted.

Suitability of Use.

Omron Companies shall not be responsible for conformity with any standards, codes or regulations which apply to the combination of the Product in the Buyer's application or use of the Product. At Buyer's request, Omron will provide applicable third party certification documents identifying ratings and limitations of use which apply to the Product. This information by itself is not sufficient for a complete determination of the suitability of the Product in combination with the end product, machine, system, or other application or use. Buyer shall be solely responsible for determining appropriateness of the particular Product with respect to Buyer's application, product or system. Buyer shall take application responsibility in all cases.

NEVER USE THE PRODUCT FOR AN APPLICATION INVOLVING SERIOUS RISK TO LIFE OR PROPERTY OR IN LARGE QUANTITIES WITHOUT ENSURING THAT THE SYSTEM AS A WHOLE HAS BEEN DESIGNED TO ADDRESS THE RISKS, AND THAT THE OMRON PRODUCT(S) IS PROPERLY RATED AND INSTALLED FOR THE INTENDED USE WITHIN THE OVERALL EQUIPMENT OR SYSTEM.

Programmable Products.

Omron Companies shall not be responsible for the user's programming of a programmable Product, or any consequence thereof.

Performance Data.

Data presented in Omron Company websites, catalogs and other materials is provided as a guide for the user in determining suitability and does not constitute a warranty. It may represent the result of Omron's test conditions, and the user must correlate it to actual application requirements. Actual performance is subject to the Omron's Warranty and Limitations of Liability.

Change in Specifications.

Product specifications and accessories may be changed at any time based on improvements and other reasons. It is our practice to change part numbers when published ratings or features are changed, or when significant construction changes are made. However, some specifications of the Product may be changed without any notice. When in doubt, special part numbers may be assigned to fix or establish key specifications for your application. Please consult with your Omron's representative at any time to confirm actual specifications of purchased Product.

Errors and Omissions.

Information presented by Omron Companies has been checked and is believed to be accurate; however, no responsibility is assumed for clerical, typographical or proofreading errors or omissions.