

Features

- Glass Passivated Die Construction
- High Case Dielectric Strength of 2500V_{RMS}
- Low Reverse Leakage Current
- Surge Overload Rating to 350A Peak
- Ideal for Printed Circuit Board Applications
- UL Listed Under Recognized Component Index, File Number E94661
- **Lead Free Finish; RoHS Compliant (Notes 1 & 2)**

Mechanical Data

- Case: GBJ
- Case Material: Molded Plastic.
UL Flammability Classification 94V-0
- Moisture Sensitivity: Level 1 per J-STD-020
- Terminals: Plated Leads, Solderable per MIL-STD-202, Method 208 **Ⓜ**
- Lead Free Plating (Tin Finish).
- Polarity: Molded on Body
- Mounting: Through Hole for #6 Screw
- Mounting Torque: 5.0 in-lbs Maximum
- Marking: Type Number
- Weight: 6.6 grams (Approximate)

Marking Information

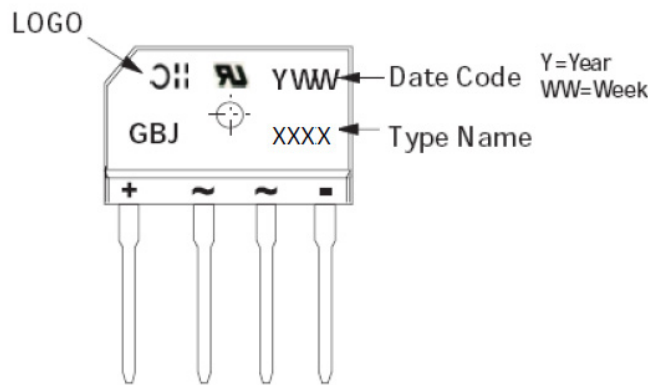

Notes: 1. EU Directive 2002/95/EC (RoHS), 2011/65/EU (RoHS 2) & 2015/863/EU (RoHS 3).compliant. All applicable RoHS exemptions applied.
2. See <https://www.diodes.com/quality/lead-free/> for more information about Diodes Incorporated's definitions of Halogen- and Antimony-free, "Green" and Lead-free.

Maximum Ratings (@T_A = 25°C, unless otherwise specified.)

Single phase, half wave, 60Hz, resistive or inductive load.
For capacitance load, derate current by 20%.

Characteristic	Symbol	GBJ 25005	GBJ 2501	GBJ 2502	GBJ 2504	GBJ 2506	GBJ 2508	GBJ 2510	Unit
Peak Repetitive Reverse Voltage Working Peak Reverse Voltage DC Blocking Voltage	V _{RRM} V _{RWM} V _R	50	100	200	400	600	800	1000	V
RMS Reverse Voltage	V _{R(RMS)}	35	70	140	280	420	560	700	V
Average Forward Rectified Output Current (Note 3) @ T _C = 100°C	I _o	25							A
Non-Repetitive Peak Forward Surge Current 8.3 ms Single Half Sine-Wave Superimposed on rated Load	I _{FSM}	350							A

Thermal Characteristics

Characteristic	Symbol	Value	Unit
Typical Thermal Resistance Junction to Case (Note 5)	R _{θJC}	1.0	°C/W
Operating and Storage Temperature Range	T _J , T _{STG}	-65 to +150	°C

Electrical Characteristics (@T_A = 25°C, unless otherwise specified.)

Characteristic	Symbol	Value	Unit
Forward Voltage (per element) @ I _F = 12.5A	V _{FM}	1.05	V
Peak Reverse Current @ T _C = 25°C at Rated DC Blocking Voltage @ T _C = 125°C	I _R	10 500	μA
I ² t Rating for Fusing (t > 1ms and < 8.3 ms) (Note 3)	I ² t	510	A ² s
Typical Total Capacitance (per element) (Note 4)	C _T	85	pF

- Notes:
3. Non-repetitive, for t > 1ms and < 8.3 ms.
 4. Measured at 1.0 MHz and applied reverse voltage of 4.0V DC.
 5. Thermal resistance from junction to case per element. Unit mounted on 250 x 250 x 20mm aluminum plate heat sink.

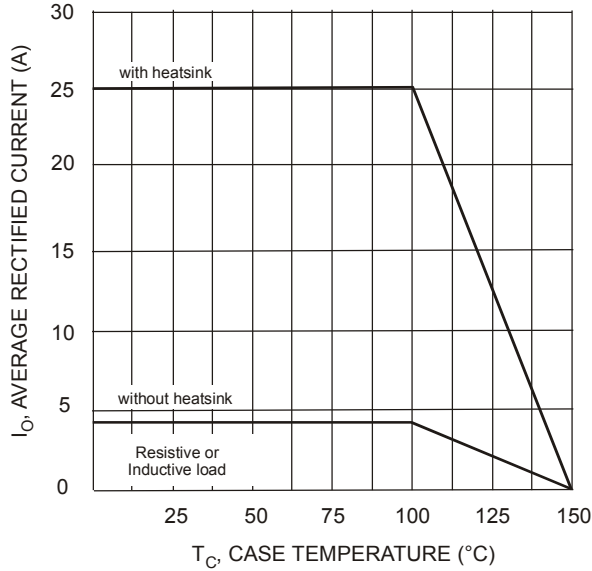

Fig. 1 Forward Current Derating Curve

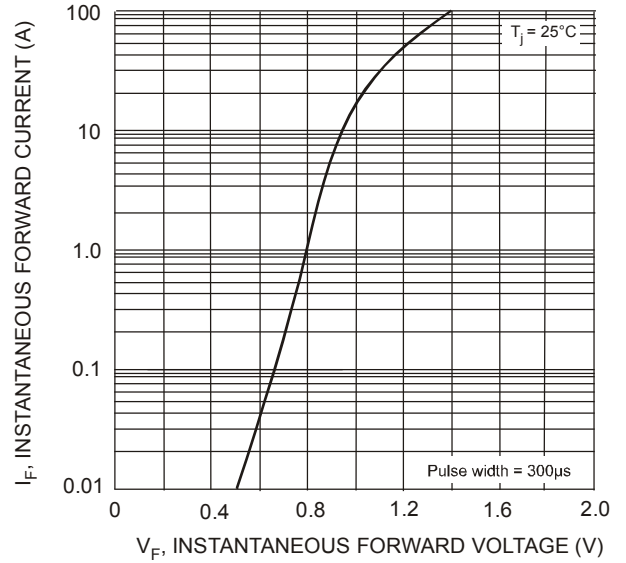

Fig. 2 Typical Forward Characteristics (per element)

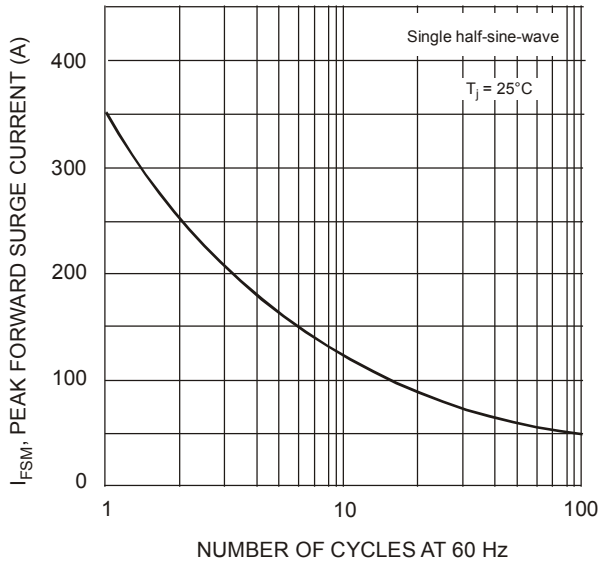

Fig. 3 Maximum Non-Repetitive Surge Current

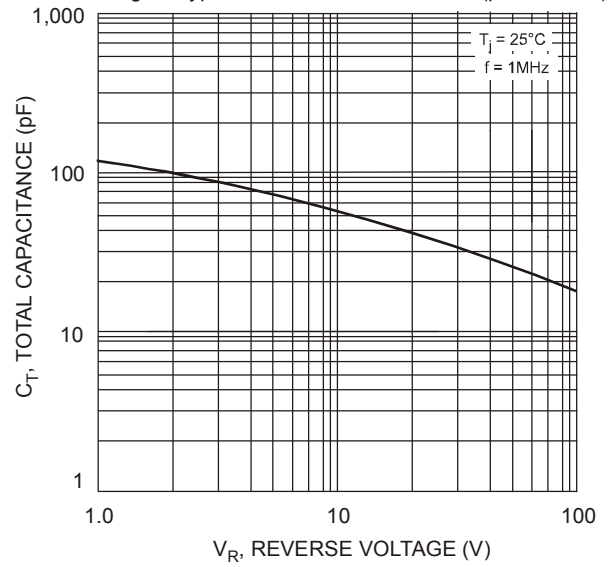

Fig. 4 Typical Total Capacitance, Per Element

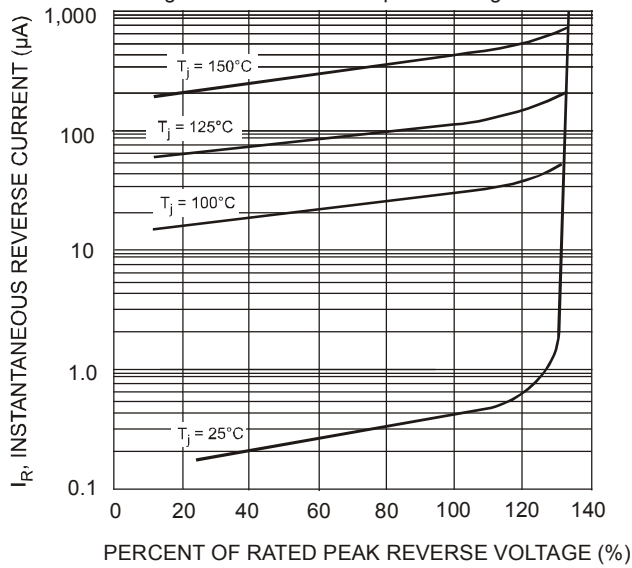

Fig. 5 Typical Reverse Characteristics

Ordering Information (Note 6)

Part Number	Case	Packaging
GBJ25005-F	GBJ	15/Tube
GBJ2501-F	GBJ	15/Tube
GBJ2502-F	GBJ	15/Tube
GBJ2504-F	GBJ	15/Tube
GBJ2506-F	GBJ	15/Tube
GBJ2508-F	GBJ	15/Tube
GBJ2510-F	GBJ	15/Tube

Note: 6. For packaging details, go to our website at <http://www.diodes.com/datasheets/ap02007.pdf>.

Package Outline Dimensions

Please see <http://www.diodes.com/package-outlines.html> for the latest version.

GBJ

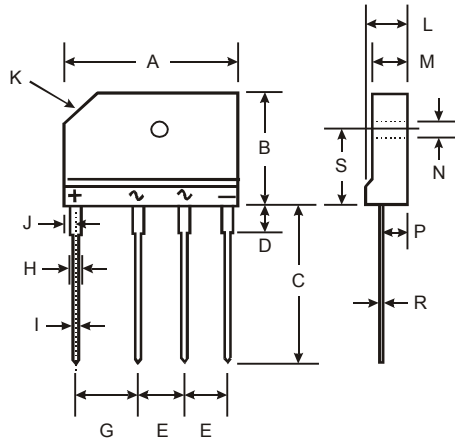

GBJ		
Dim	Min	Max
A	29.70	30.30
B	19.70	20.30
C	17.00	18.00
D	3.80	4.20
E	7.30	7.70
G	9.80	10.20
H	2.00	2.40
I	0.90	1.10
J	2.30	2.70
K	3.0 X 45°	
L	4.40	4.80
M	3.40	3.80
N	3.10	3.40
P	2.50	2.90
R	0.60	0.80
S	10.80	11.20
All Dimensions in mm		

Note: For high voltage applications, the appropriate industry sector guidelines should be considered with regards to creepage and clearance.