

# Midi-Contactors

## Specifications



Type		Model
		Connection by screws clamp terminals
		Connection by lugs
Number of poles		
Rated operational voltage, Ue		
Rated insulation voltage, Ui		
		Conforming to IEC947-4-1
		Conforming to UL, CSA
Rated impulse withstand voltage, Uimp		
Degree of pollution (IEC60529)		
Rated operational current Ie ( $\theta \leq 55^\circ\text{C}$ )		
AC Motors	1-Phase	Ue Max 690 [A]
		110~120V [A]
		220~240V [A]
	3-Phase	200~240V [A]
		220~240V [A]
		440~480V [A]
550~600V [A]		
Rated operational power ( $\theta \leq 55^\circ\text{C}$ )		
AC Motors	1-Phase	110~120V [Hp]
		220~240V [Hp]
	3-Phase	200~208V [Hp]
		220~240V [Hp]
		440~480V [Hp]
	550~600V [Hp]	
Rated operational current (440V AC-3) [A]		
CSA Elevator Ratings 200~600V 3 Phase [A]		
According to IEC 947-4-1	Rated making capacity AC-3 (I/Ie) [440V]	
	Rated breaking capacity AC-3 (Ic/Ie) [440V]	
Mechanical durability in millions of operating cycles		
Maximum operating rate In operating cycles per hour		
Mechanical durability in millions of operating cycles		
Maximum operating rate In operating cycles per hour		
Electrical life for Ie/AC-3 Max in millions of operating cycles		
Maximum operating rate in operating cycles per hour		
AC control coil voltage operated contactors		
	Weight [kg]	
	Basic dimensions (W x H x D) [mm]	
DC control coil voltage operated contactors		
	Weight [kg]	
	Basic dimensions (W x H x D) [mm]	

12AF		32AF		
GC9	GC12	GC18	GC25	GC32
●	●	●	●	●
N/A	N/A	N/A	N/A	N/A
3				
690V				
1000V				
600V				
8kV				
IP20				
25	25	40	40	50
9.8	13.8	16	24	26
10	12	17	17	28
7.5	10.6	16.7	24.2	24.2
9.6	15.2	22	28	28
7.6	11	11	21	27
9	11	17	22	27
0.5	0.75	1	2	2
1.5	2	3	3	5
2	3	5	7.5	7.5
3	5	7.5	10	10
5	7.5	10	15	25
7.5	10	15	20	25
9	12	18	25	32
Available in 2009	Available in 2009	20	20	25
90	120	180	250	320
72	96	144	200	256
15	15	15	15	15
1800	1800	1800	1800	1800
8.07	8.07	8.07	8.07	8.07
7200	7200	7200	7200	7200
2.5	2.5	2.5	2.5	2.5
1800	1800	1800	1800	1800
0.45				
45 x 83 x 93				
0.63				
45 x 83 x 118				

# Midi-Contactors



**63AF**

GC35	GC40	GC50	GC63
•	•	•	•
•	•	•	•
3			
690V			
1000V			
600V			
8kV			
IP20			
55	60	70	75
24	34	34	56
28	40	50	50
30.8	46.2	54.4	54.4
42	54	68	68
34	40	52	52
32	41	52	52
2	3	3	5
5	7.5	10	10
10	15	20	20
15	20	25	25
25	30	40	40
30	40	50	50
35	40	50	63
30	32.5	37.5	42
350	400	500	630
280	320	400	504
12	12	12	12
1200	1200	1200	1200
5.97	5.97	5.97	5.97
7200	7200	7200	7200
2	2	2	1.3
1200	1200	1200	1200
0.94			
55 × 106 × 122			
1.2			
55 × 106 × 160.5			



**95AF**

GC65	GC75	GC85	GC95
•	•	•	•
•	•	•	•
3			
690V			
1000V			
600V			
8kV			
IP20			
100	110	135	140
56	56	80	100
68	68	68	88
74.8	74.8	88	88
80	80	104	104
65	65	77	96
62	62	77	77
5	5	7.5	10
15	15	15	20
25	25	30	30
30	30	40	60
50	50	60	75
60	60	75	75
65	75	85	95
55	60	70	75
650	750	850	950
520	600	680	760
12	12	12	12
1200	1200	1200	1200
5.97	5.97	5.97	5.97
7200	7200	7200	7200
2	2	2	2
1200	1200	1200	1200
1.82			
70 × 140 × 137			
2.7			
70 × 140 × 172.5			

# Midi-Contactors

## 3-pole contactors

### for motor control up to 45kW at 440V in category AC-3

Control circuit voltage : AC or DC

Connection by screw clamp terminals



GC12S



GC32S



GC63S



GC95S

AC-3 operational power ratings 3-phase motors ( $\theta \leq 55^\circ\text{C}$ )						Rated operational current at AC-3	Built-in auxiliary contacts		Type	Weight
200 240V	380 400V	415V	440V	500V	690V		440V	NO	NC	Connection by screw clamp terminals
kW	kW	kW	kW	kW	kW	A				
2.5	4	4	4	4	4	9	1	0*	GC9S	0.26
3.5	5.5	5.5	5.5	7.5	7.5	12	1	0*	GC12S	0.26
4.5	7.5	7.5	7.5	7.5	7.5	18	1	1	GC18S	0.45
5.5	11	11	11	15	15	25	1	1	GC25S	0.45
11	18.5	18.5	18.5	22	22	32	1	1	GC32S	0.45
7.5	15	15	15	18.5	18.5	35	2	2	GC35S	0.94
11	18.5	18.5	18.5	22	22	40	2	2	GC40S	0.94
15	22	22	22	30	30	50	2	2	GC50S	0.94
15	25	25	25	30	30	63	2	2	GC63S	0.94
18.5	30	30	30	33	33	65	2	2	GC65S	1.82
22	37	37	37	37	37	75	2	2	GC75S	1.82
25	45	45	45	45	45	85	2	2	GC85S	1.82
25	45	45	45	50	45	95	2	2	GC95S	1.82

#### Accessories

Auxiliary contact blocks and modules: see pages B-1-13 to B-1-17.

#### Mounting

Clip-on mounting on 35 mm  $\square$  rail or screw fixing.

GC65 to GC95 types are mountable on 70mm DIN rail.

#### Standard control circuit voltage, Coil voltage

- AC circuit 50/60Hz  
50Hz : 24, 32, 36, 42, 48, 80, 100, 110, 220, 230, 240, 380, 400, 415, 440, 500, 550V  
60Hz : 24, 48, 100, 110, 120, 200, 208, 220, 230, 240, 277, 380, 440, 480, 600V  
50/60Hz : 24, 48, 100, 110, 120, 200, 220, 230, 240, 380, 415, 440, 500, 550V

- DC circuit  
12, 20, 24, 48, 60, 80, 100, 110, 125, 200, 220, 250V

Overloads to suit contactors are on page B-2-2.

\* 1NC version is also available

## 3-pole contactors

for control in utilization category AC-1, 25 to 140 A

Control circuit voltage : AC or DC

Connection by screw clamp terminals



GC12S



GC32S



GC63S



GC95S

AC-1 Non inductive loads maximum current ( $\theta \leq 55^\circ\text{C}$ )	Number of poles	Built-in auxiliary contacts		Type	Weight
		NO	NC	Connection by screw clamp terminals	AC control kg
AC-1 (A)	NO	NO	NC		
25	3	1	0*	GC9S	0.26
25	3	1	0*	GC12S	0.26
40	3	1	1	GC18S	0.45
40	3	1	1	GC25S	0.45
50	3	1	1	GC32S	0.45
55	3	2	2	GC35S	0.94
60	3	2	2	GC40S	0.94
70	3	2	2	GC50S	0.94
75	3	2	2	GC63S	0.94
100	3	2	2	GC65S	1.82
110	3	2	2	GC75S	1.82
135	3	2	2	GC85S	1.82
140	3	2	2	GC95S	1.82

### Accessories

Auxiliary contact blocks and modules: see pages B-1-13 to B-1-17.

### Mounting

Clip-on mounting on 35 mm  $\square$  rail or screw fixing.

GC65 to GC95 types are mountable on 70mm DIN rail.

### Standard control circuit voltage, Coil voltage

#### • AC circuit 50/60Hz

50Hz : 24, 32, 36, 42, 48, 80, 100, 110, 220, 230, 240, 380, 400, 415, 440, 500, 550V

60Hz : 24, 48, 100, 110, 120, 200, 208, 220, 230, 240, 277, 380, 440, 480, 600V

50/60Hz : 24, 48, 100, 110, 120, 200, 220, 230, 240, 380, 415, 440, 500, 550V

#### • DC circuit

12, 20, 24, 48, 60, 80, 100, 110, 125, 200, 220, 250V

Overloads to suit contactors are on page B-2-2.

\* 1NC version is also available

# Midi-Contactors

## 3-pole contactors

### for motor control up to 45kW at 440V in category AC-3

Control circuit voltage : AC or DC

Connection by lugs



GC63L



GC95L

AC-3 operational power ratings 3-phase motors ( $\theta \leq 55^\circ\text{C}$ )						Rated operational current at AC-3	Built-in auxiliary contacts		Type	Weight
200 240V	380 400V	415V	440V	500V	690V		440V	NO	NC	Connection by lugs terminals
kW	kW	kW	kW	kW	kW	A				
7.5	15	15	15	18.5	18.5	35	2	2	GC35L	0.94
11	18.5	18.5	18.5	22	22	40	2	2	GC40L	0.94
15	22	22	22	30	30	50	2	2	GC50L	0.94
15	25	25	25	30	30	63	2	2	GC63L	0.94
18.5	30	30	30	33	33	65	2	2	GC65L	1.82
22	37	37	37	37	37	75	2	2	GC75L	1.82
25	45	45	45	45	45	85	2	2	GC85L	1.82
25	45	45	45	50	45	95	2	2	GC95L	1.82

#### Accessories

Auxiliary contact blocks and modules: see pages B-1-13 to B-1-17.

#### Mounting

Clip-on mounting on 35 mm  rail or screw fixing.  
GC65 to GC95 types are mountable on 70mm DIN rail.

#### Standard control circuit voltage, Coil voltage

- AC circuit 50/60Hz  
50Hz : 24, 32, 36, 42, 48, 80, 100, 110, 220, 230, 240, 380, 400, 415, 440, 500, 550V  
60Hz : 24, 48, 100, 110, 120, 200, 208, 220, 230, 240, 277, 380, 440, 480, 600V  
50/60Hz : 24, 48, 100, 110, 120, 200, 220, 230, 240, 380, 415, 440, 500, 550V
- DC circuit  
12, 20, 24, 48, 60, 80, 100, 110, 125, 200, 220, 250V

Overloads to suit contactors are on page B-2-2.

# Midi-Contactors

## 3-pole contactors for control in utilization category AC-1, 25 to 140 A

Control circuit voltage : AC or DC

Connection by lugs



GC63L



GC95L

AC-1 Non inductive loads maximum current ( $\theta \leq 55^\circ\text{C}$ )	Number of poles	Built-in auxiliary contacts		Type	Weight
		NC	NO	Connection by lugs terminals	AC control kg
AC-1 (A)	NO	NC	NO		
55	3	2	2	GC35L	0.94
60	3	2	2	GC40L	0.94
70	3	2	2	GC50L	0.94
75	3	2	2	GC63L	0.94
100	3	2	2	GC65L	1.82
110	3	2	2	GC75L	1.82
135	3	2	2	GC85L	1.82
140	3	2	2	GC95L	1.82

### Accessories

Auxiliary contact blocks and modules: see pages B-1-13 to B-1-17.

### Mounting

Clip-on mounting on 35 mm  $\tau$  rail or screw fixing.  
GC65 to GC95 types are mountable on 70mm DIN rail.

### Standard control circuit voltage, Coil voltage

- AC circuit 50/60Hz
  - 50Hz : 24, 32, 36, 42, 48, 80, 100, 110, 220, 230, 240, 380, 400, 415, 440, 500, 550V
  - 60Hz : 24, 48, 100, 110, 120, 200, 208, 220, 230, 240, 277, 380, 440, 480, 600V
  - 50/60Hz : 24, 48, 100, 110, 120, 200, 220, 230, 240, 380, 415, 440, 500, 550V
- DC circuit
  - 12, 20, 24, 48, 60, 80, 100, 110, 125, 200, 220, 250V

Overloads to suit contactors are on page B-2-2.

## Control circuit characteristics



Type	32AF	63AF	95AF
Contactor types	GC9 GC12 GC18 GC25 GC32	GC35 GC40 GC50 GC63	GC65 GC75 GC85 GC95
AC control circuit characteristics			
Rated control circuit voltage [Uc]	24, 32, 36, 42, 48, 80, 100, 110, 220, 230, 240, 380, 400, 415, 440, 500, 550V		
50Hz [V]	24, 48, 100, 110, 120, 200, 208, 220, 230, 240, 277, 380, 440, 480, 600V		
60Hz [V]	24, 48, 100, 110, 120, 200, 220, 230, 240, 380, 415, 440, 500, 550V		
50/60Hz [V]			
Control voltage limits			
Operational	0.85 ... 1.1 Uc on 50 Hz		
	0.85 ... 1.1 Uc on 60 Hz		
Drop-out	0.3 ... 0.6 Uc		
Coil consumption at 20°C			
Inrush [VA]	80	120	220
Holding [VA]	9	11	16
Heat dissipation [W]	2.2	2.2	5.1
Operating time			
Closing [ms]	12 ... 22	12 ... 22	15 ... 30
Opening [ms]	4 ... 19	4 ... 19	15 ... 30
DC control circuit characteristics			
Rated control circuit voltage [Uc]	12, 20, 24, 48, 60, 80, 100, 110, 125, 200, 220, 250		
Control voltage limits			
Operational	0.7 ... 1.1Uc		
Drop-out	0.1 ... 0.3 Uc		
Coil consumption at 20°C			
Inrush [W]	7	9	18
Holding [W]	7	9	18
Time constant (L/R) [ms]	28	65	75
Operating time			
Closing [ms]	12 ... 22	12 ... 22	100 ... 120
Opening [ms]	4 ... 19	4 ... 19	10 ... 25

# Overall Dimensions

## Circuit diagram

GC9~95

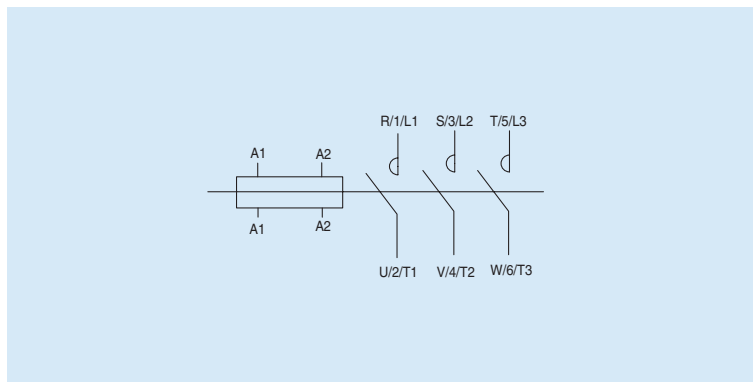

GC9~95 2N02NC

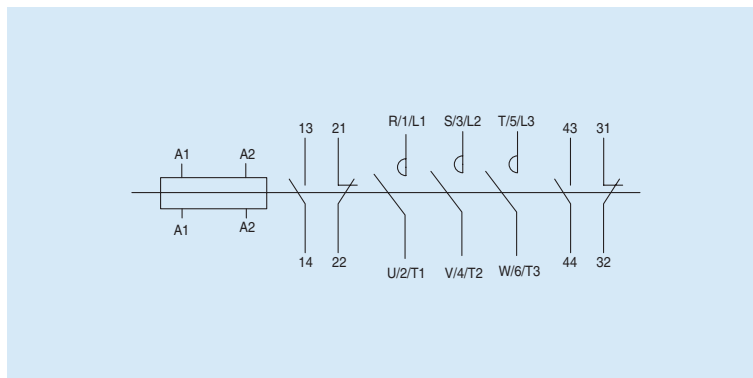

GC9~95

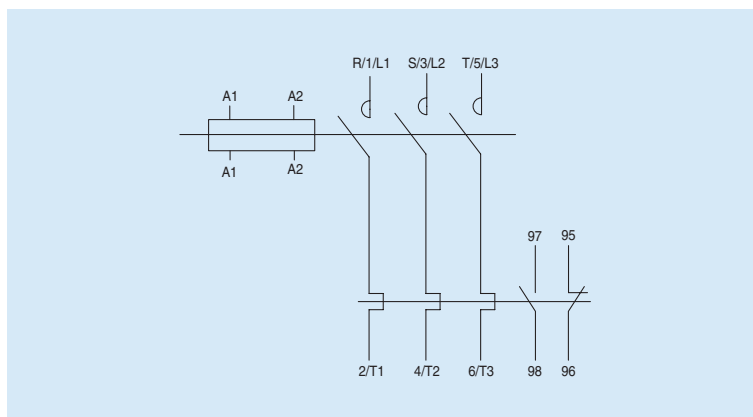



# Overall Dimensions

## Contactors

**GC-9~12 AC**

**1a or 1b**

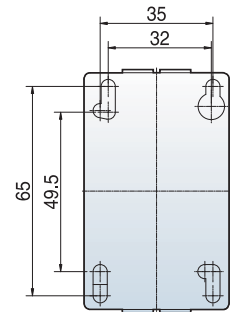
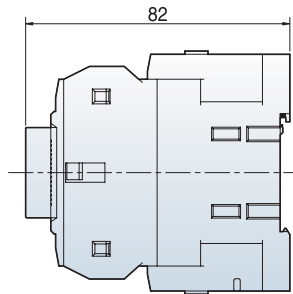
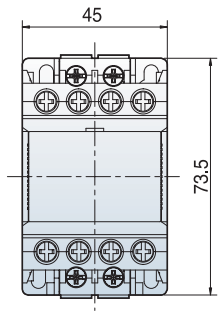

[mm]

0.262kg

**GC-9~12 DC**

**1a or 1b**

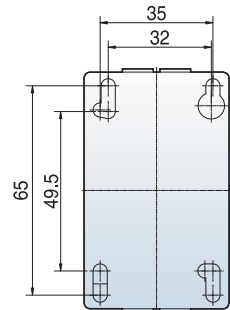
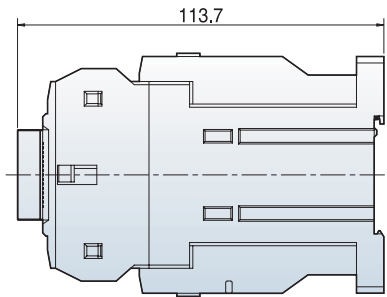
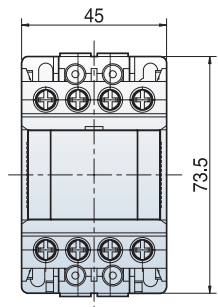

0.468kg

**GC-18~32 AC**

**1a1b**

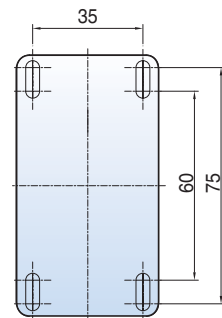
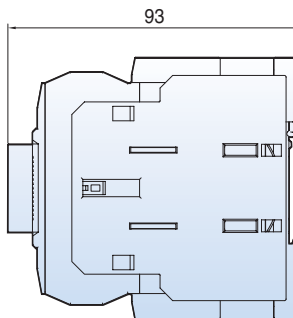
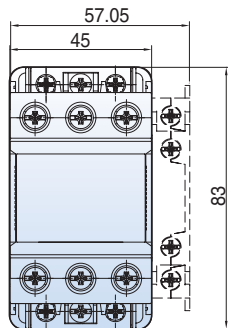

0.549kg

**GC-18~32 DC**

**1a1b**

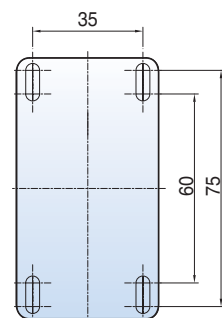
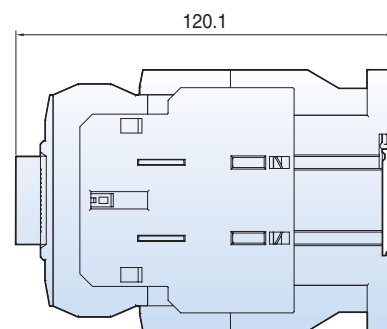
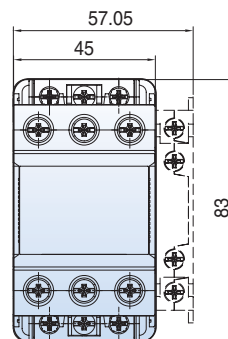

0.765kg

# Overall Dimensions

## Contactors

[mm]

**GC-35-63 AC**  
2a2b

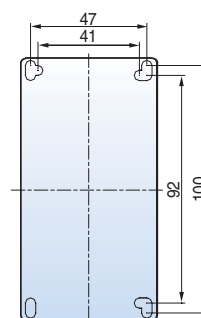
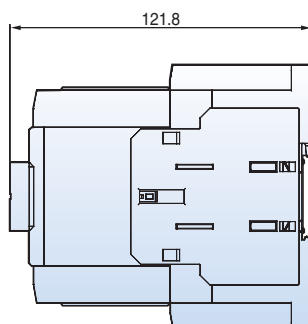
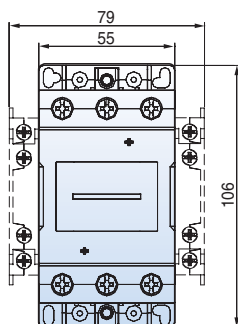

1.045kg

**GC-35-63 DC**  
2a2b

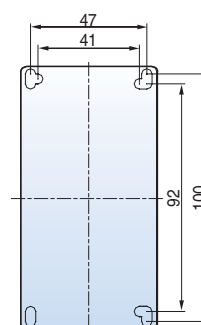
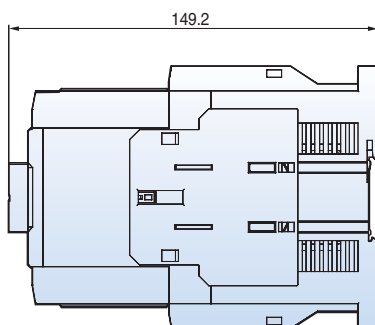
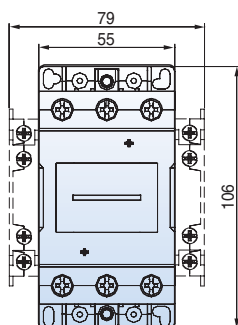

1.301kg

# Overall Dimensions

## Contactors

[mm]

**GC-65-95 AC**  
**2a2b**

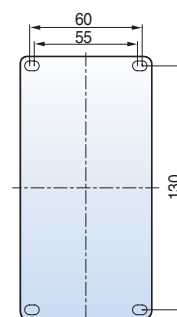
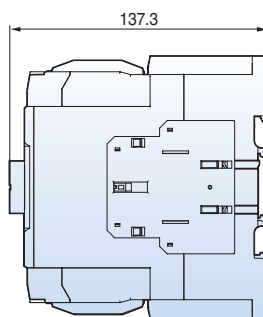
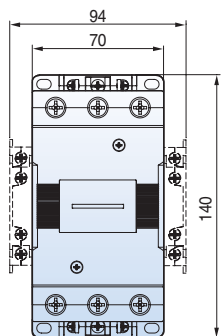

1.925kg

**GC-65-95 DC**  
**2a2b**

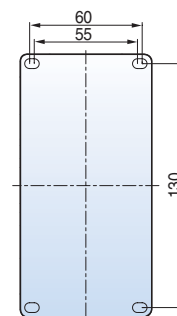
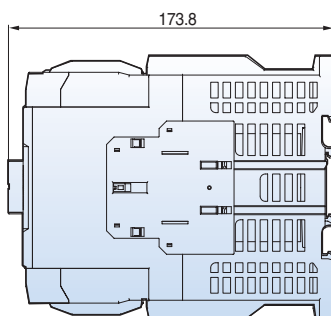
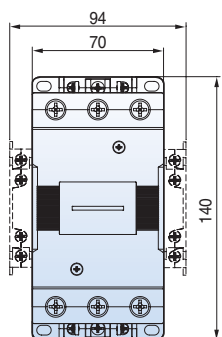

2.805kg

# Overall Dimensions

## Combination manual motor starters and contactors

[mm]

GMS-32S

+

GC32AF

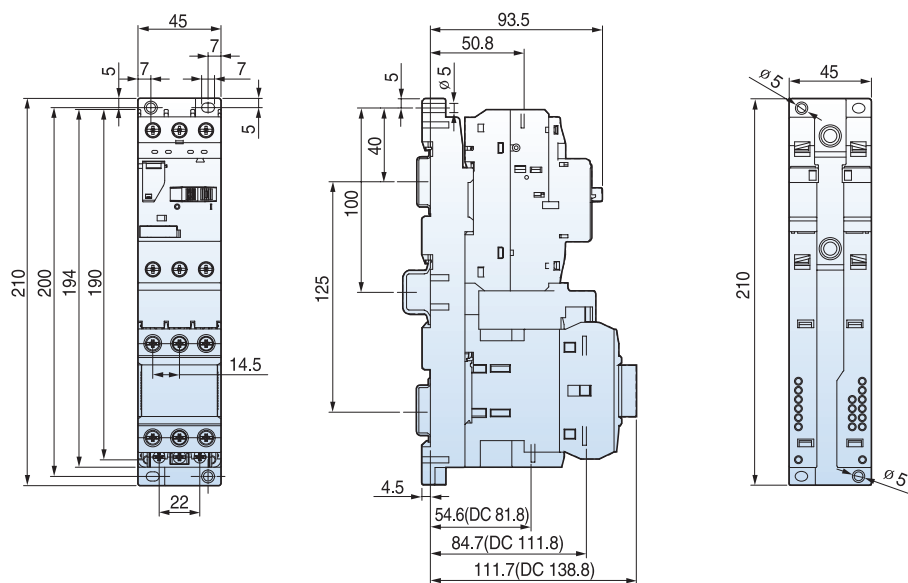

GMS-32H

+

GC32AF

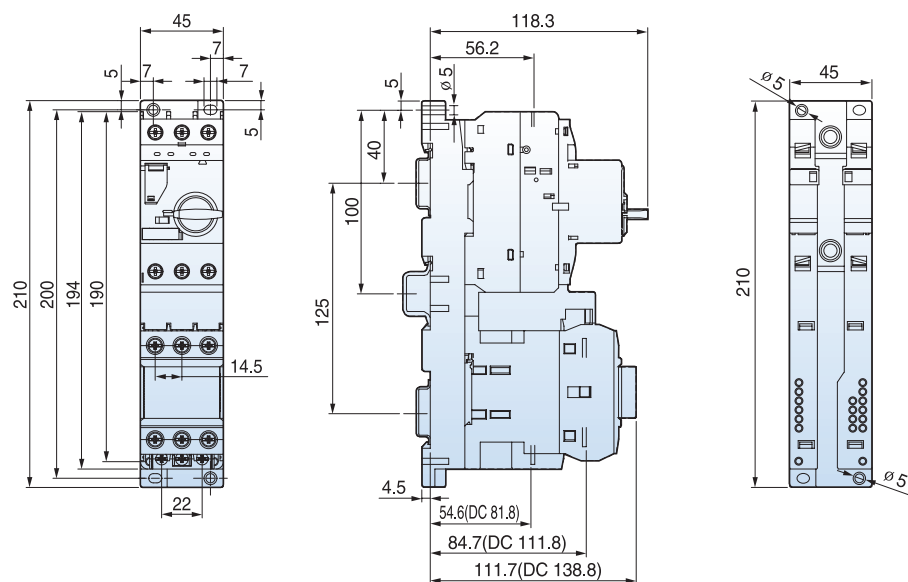

# Overall Dimensions

## Combination manual motor starters and contactors

[mm]

GMS-63H

+

GC63AF

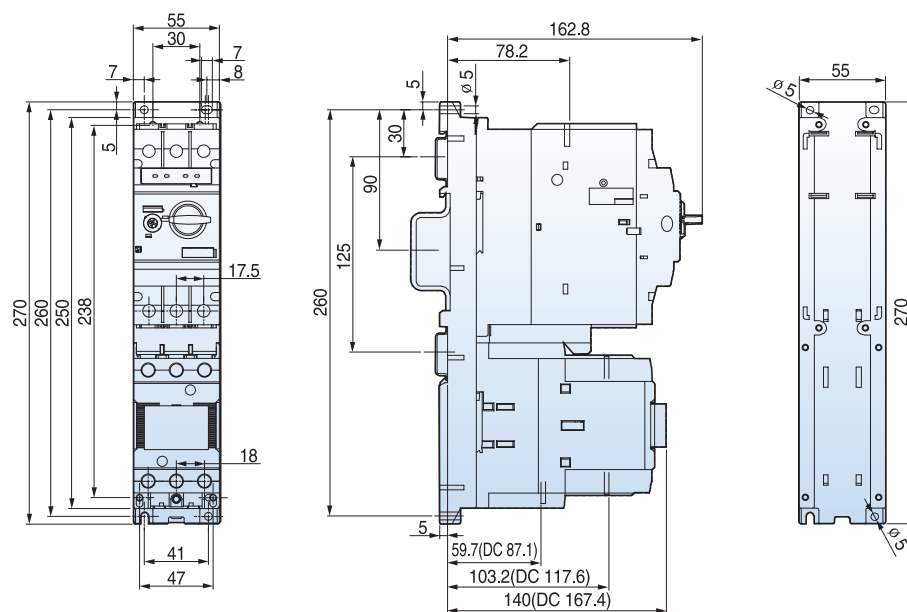

GMS-100H

+

GC95AF

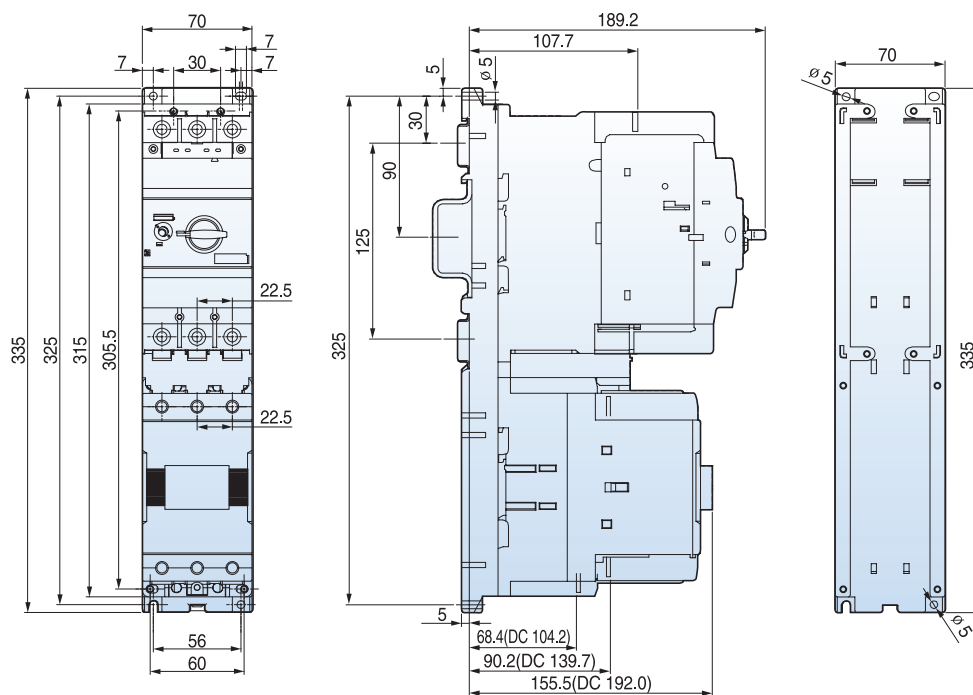

# Overall Dimensions

## Motor starters (Screw type)

- GS18
- GS25
- GS32

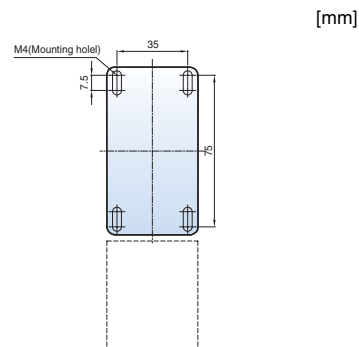
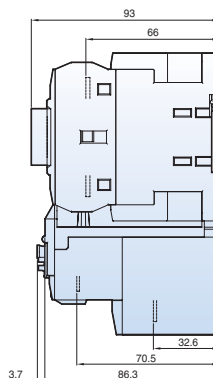
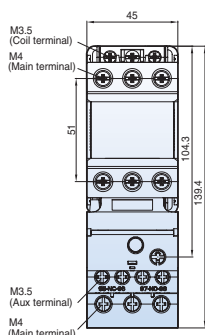

[mm]

0.61kg

- GS35
- GS40
- GS50
- GS63

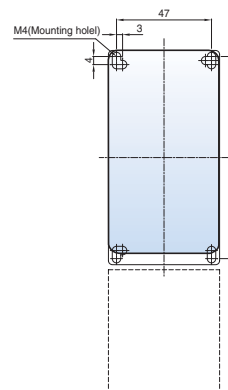
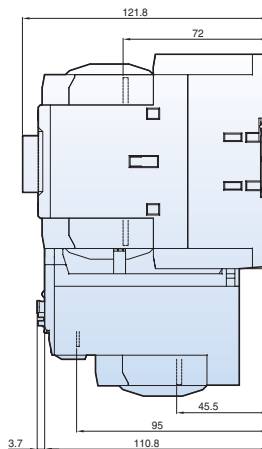
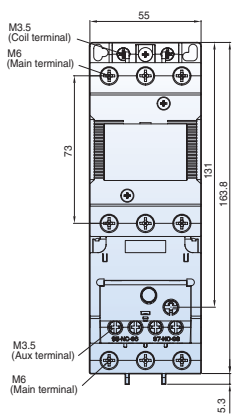

1.14kg

- GS-65
- GS-75
- GS-85
- GS-95

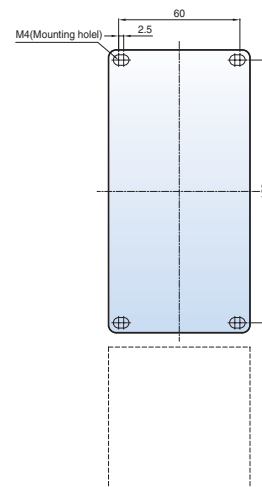
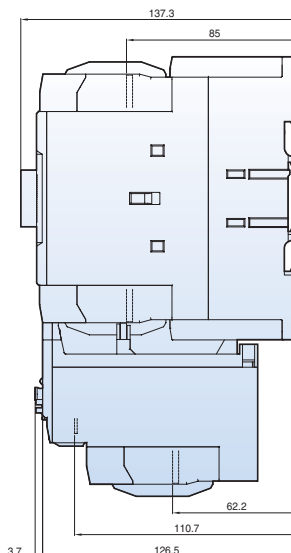
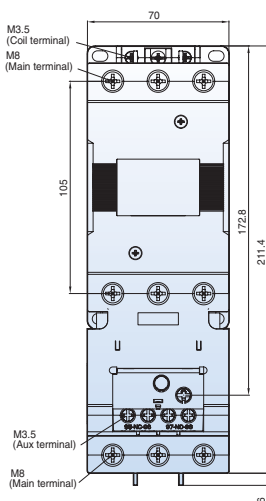

2.19kg

# Overall Dimensions

## Motor starters (Lug type)

[mm]

GS35L

GS40L

GS50L

GS63L

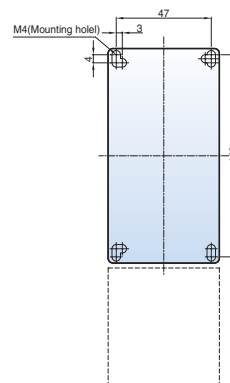
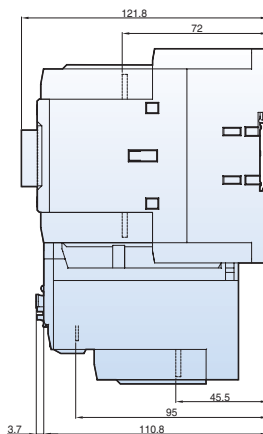
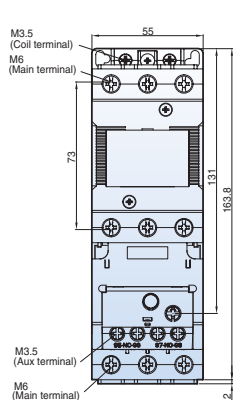

1.14kg

GS65L

GS75L

GS85L

GS95L

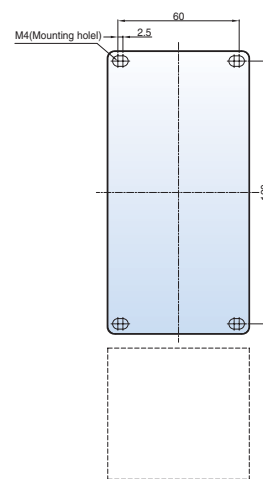
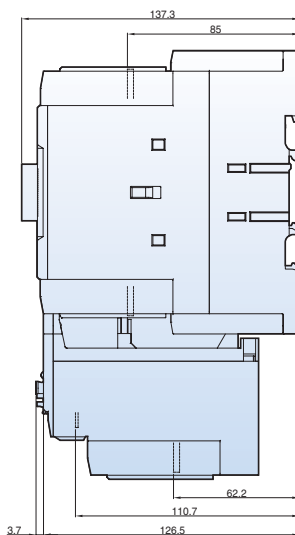
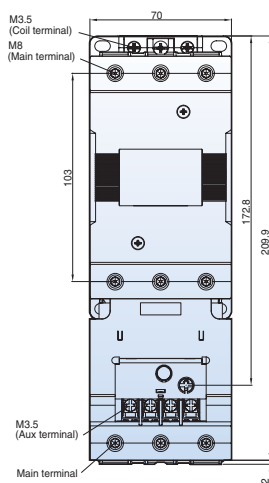

2.19kg