

GigaDevice Semiconductor Inc.

GD30LD3300x
3A High-accuracy, Low Noise LDO

Datasheet

Table of Contents

Table of Contents	2
List of Figures	4
List of Tables	5
1 Features	6
2 Applications	6
3 General description	6
4 Device overview	8
4.1 Device information	8
4.2 Block diagram	8
4.3 Pinout and pin assignment	9
4.4 Pin definitions	9
5 Functional description	11
5.1 Output Voltage Setting	11
5.2 Recommended device selection	11
5.2.1 C _{IN} and C _{OUT} Selection	11
5.2.2 Feed-Forward Capacitor (C _{FF})	12
5.3 Low-Noise, High-RSRR Output	12
5.4 Power-Good Function	12
5.5 Soft-Start Function	14
5.6 Undervoltage Lockout (UVLO)	14
5.7 Power Dissipation (P_D)	15
6 Electrical characteristics	17
6.1 Absolute maximum ratings	17
6.2 Recommended Operating Conditions	17
6.3 Electrical sensitivity	18
6.4 Electrical Specifications	18
6.5 Typical Characteristics	21
7 Typical application circuit	30
8 Layout guideline	33
9 Package information	34



9.1	QFN20 package outline dimensions.....	34
9.2	Thermal characteristics	36
10	Ordering information.....	37
11	Revision history.....	38

List of Figures

Figure 4-1 Block diagram for GD30LD3300x	8
Figure 4-2 GD30LD3300x QFN20 pinouts	9
Figure 5-1 Typical PG Operation.....	13
Figure 5-2 Typical UVLO Operation	14
Figure 7-1 Typical GD30LD3300x application circuit with adjustable resistance.....	30
Figure 7-2 Typical GD30LD3300x application circuit with pin-setting	31
Figure 8-1 Typical GD30LD3300x layout guideline	33
Figure 9-1 QFN20 package outline.....	34
Figure 9-2 QFN20 recommend footprint.....	35

List of Tables

Table 4-1 Device information for GD30LD3300x	8
Table 4-2 GD30LD3300x QFN20 pin definitions	9
Table 5-1 Typical PG Operation Description	13
Table 5-2 Typical UVLO Operation Description	15
Table 6-1 Absolute maximum ratings	17
Table 6-2 Recommended Operating Conditions	17
Table 6-3 Electrostatic Discharge characteristics.....	18
Table 6-4 Electrical characteristics.....	18
Table 7-1 Adjusted V_{OUT} by external feedback resistor.....	30
Table 7-2 Adjusted V_{OUT} by pin-setting	31
Table 9-1 QFN20 dimensions	34
Table 9-2 Package thermal characteristics ⁽¹⁾	36
Table 10-1 Part ordering code for GD30LD3300x devices.....	37
Table 11-1 Revision history	38

1 Features

- Input Voltage Range
 - With BIAS: 1.1 V to 6.5 V
 - Without BIAS: 1.4 V to 6.5 V
- Output Voltage Range
 - 0.5 V to 5.2 V, Set by a Resistor Divider
 - 0.5 V to 2.075 V, Pin-Setting, No External Resistor
- Accurate Output Voltage Accuracy: 1%, Over Line, Load and Temperature
- Ultra Low Dropout Voltage: Maximum 180 mV at 3 A with BIAS
- Ultra High PSRR: 39 dB at 500 KHz
- Excellent Noise Immunity
 - 5.9 uVRMS at 0.5 V Output
 - 9.8 uVRMS at 5 V Output
- Enable Function
- Programmable Soft-Start
- Power-Good Indicator Function

2 Applications

- Wireless Infrastructure: 5G AAU, 4G RRU....
- Telecom/Networking Cards
- Industrial Application

3 General description

The GD30LD3300x is a high-current, low-noise, high accuracy, low-dropout linear regulator (LDO) capable of sourcing 3 A with extreme low dropout (max, 180 mV).

The device output voltage is pin-selectable from 0.5 V to 2.075 V and adjustable from 0.5 V to 5.2 V using the external resistor divider. The device supports input supply voltage as low to 1.1 V with BIAS and as low to 1.4 V without BIAS.

The low noise, high PSRR and high output current capability makes the GD30LD3300xx ideal to power noise-sensitive devices such as analog-to-digital converters (ADCs), digital-to-analog converters (DACs), and RF components. With very high accuracy, remote sensing, and soft-start capabilities to reduce inrush current, the GD30LD3300x is ideal for powering digital loads such as FPGAs, DSPs, and ASICs.

The external enable control and power good indicator function makes the control sequence easier. The output noise immunity is enhanced by adding external bypass capacitor on

NR/SS pin. The device is fully specified over the temperature range of $T_J = -40^{\circ}\text{C}$ to 125°C and is offered in a QFN20 3.5x3.5 package.

4 Device overview

4.1 Device information

Table 4-1 Device information for GD30LD3300x

Part Number	Package	Function	Description
GD30LD3300x	QFN20(3.5X3.5)	With EN enable pin	3A High accuracy and Low noise

4.2 Block diagram

Figure 4-1 Block diagram for GD30LD3300x

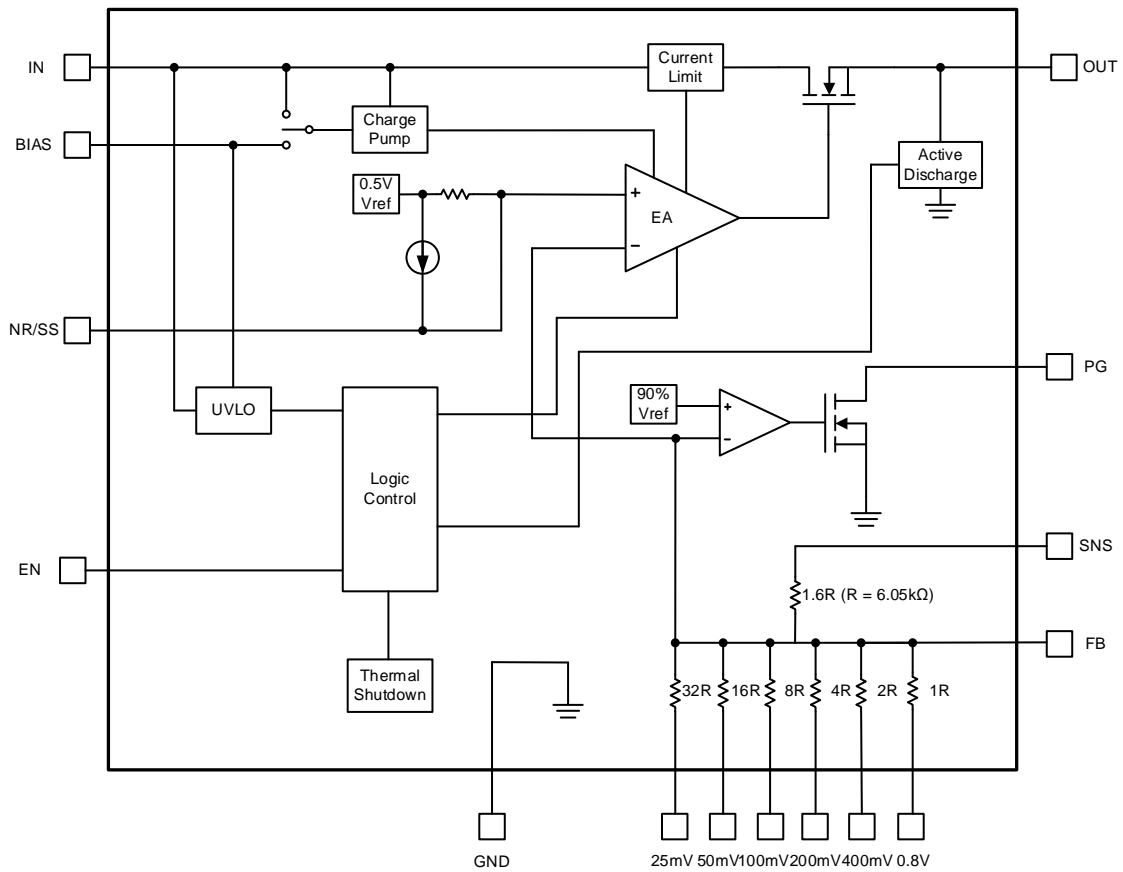

4.3 Pinout and pin assignment

Figure 4-2 GD30LD3300x QFN20 pinouts

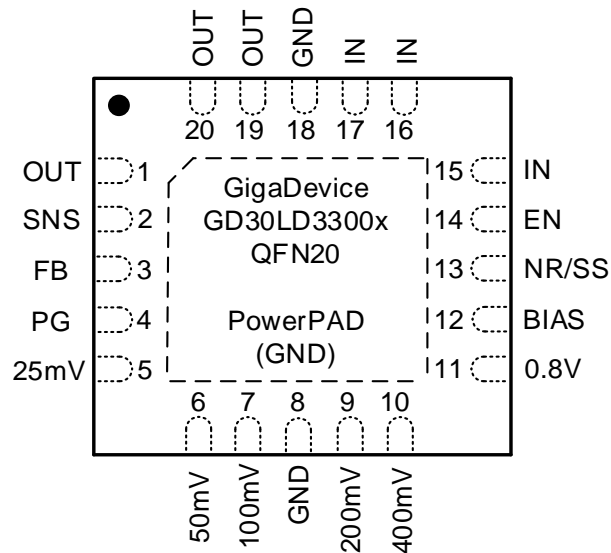

4.4 Pin definitions

Table 4-2 GD30LD3300x QFN20 pin definitions

Pin Name	Pins	Pin Type	Functions description
OUT	1, 19, 20	O	LDO output pins. The larger ceramic capacitor (47uF or 2 x 22uF or greater) is stable. Place the output capacitor as close to the device as possible. Minimize the impedance between V_{OUT} pin to load.
SNS	2	I	Output voltage sense input pin. Connect this pin only if using the configuration without external resistors. Keep SNS pin floating if the V_{OUT} voltage is set by external resistor.
FB	3	I	Feedback voltage input. This pin is used to set the desired output voltage via an external resistive divider. The feedback reference voltage is 0.5 V typically.
PG	4	O	Power good indicator output. An open-drain output and active high when the output voltage reaches 89% of the target. The pin is pulled to ground when the output voltage is lower than its specified threshold, EN shutdown, OCP and OTP.

Pin Name	Pins	Pin Type	Functions description
25 mV,50 mV 100mV,200mV 400mV,0.8V	5,6,7,9,10,11	O	Output voltage setting pins. Connect these pins to ground or leave floating. Connecting these pins to ground increases the output voltage by the value of the pin name; multiple pins can be simultaneously connected to GND to select the desired output voltage. Leave these pins floating (open) if the V_{OUT} voltage is set by external resistor.
GND	8,18,21 Thermal pad	G	Ground. The exposed pad must be soldered to a large PCB and connected to GND for maximum power dissipation.
BIAS	12	I	BIAS supply voltage. This pin enables the use of low-input voltage, low-output (LILLO) voltage conditions (that is, $V_{IN} = 1.2\text{ V}$, $V_{OUT} = 1\text{ V}$) to reduce power dissipation across the die. The use of a BIAS voltage improves dc and ac performance for $V_{IN} \leq 2.2\text{ V}$. A $1\mu\text{F}$ capacitor or larger must be connected between this pin and ground. If not used, this pin must be left floating or tied to ground.
NR/SS	13	I	Noise-reduction and soft-start pin. Decouple this pin to GND with an external capacitor $C_{NR/SS}$ can not only reduce output noise to very low levels but also slow down the rising of V_{OUT} , providing a soft-start behavior. For low noise applications, a 10nF to 100nF $C_{NR/SS}$ is suggested.
EN	14	I	Enable control input. Connecting this pin to logic high enables the regulator, and driving this pin low puts it into shutdown mode. The device can have V_{IN} and V_{EN} sequenced in any order without causing damage to the device. However, for the soft-start function to work as intended, certain sequencing rules must be applied. Enabling the device after V_{IN} is preferred.
IN	15,16,17	I	Supply input. A general $10\mu\text{F}$ or larger ceramic capacitor should be placed as close as possible to this pin for better noise rejection.

Notes:

1. Type: I = input, O = output, I/O = input or output, P = power, G = Ground.

5 Functional description

5.1 Output Voltage Setting

The output voltage of the GD30LD3300x can be set by external resistors or by using the output voltage setting pins (25 mV, 50 mV, 100 mV, 200 mV, 400 mV and 0.8 V) to achieve different output targets.

By using external resistors, the output voltage is determined by the values of R1 and R2 as shown in Table 7-1. The values of R1 and R2 can be calculated for any voltage value using the following formula:

$$V_{OUT} = V_{FB} \times \left(1 + \frac{R_1}{R_2} \right)$$

The GD30LD3300x can also short pins 5, 6, 7, 9, 10, and 11 to ground and program the regulated output voltage level without external resistors after the SNS pin is connected to the V_{OUT}. Pins 5, 6, 7, 9, 10, and 11 are connected with internal resistor pairs. Each pin is either connected to ground (active) or left open (floating). Voltage programming is set as the sum of the internal reference voltage (V_{FB} = 0.5V) plus the accumulated sum of the respective voltages assigned to each active pin as illustrated in Table 7-2.

$$V_{OUT} = V_{FB} + V_{PIN-SET}$$

5.2 Recommended device selection

5.2.1 C_{IN} and C_{OUT} Selection

The GD30LD3300x is designed to support low-series resistance (ESR) ceramic capacitors. It is recommended to use ceramic capacitors with X7R, X5R, and C0G-rated ceramic capacitors to get good capacitive stability across different temperatures.

However, the capacitance of ceramic capacitors varies with operating voltage and temperature, and the design engineer must be aware of these characteristics. Ceramic capacitors are usually recommended to be derated by 50%. A 47μF or greater output ceramic capacitor is suggested to ensure stability. Input capacitance is selected to minimize transient input drop during load current steps. For general applications, an input capacitor of at least 10μF is highly recommended for minimal input impedance. If the trace inductance between the GD30LD3300x input pin and power supply is high, a fast load transient can cause V_{IN} voltage level ringing above the absolute maximum voltage rating which damages the device. Adding more input capacitors is available to restrict the ringing and keep it below the device absolute maximum ratings.

Generally, a 47μF 0805-sized ceramic capacitor in parallel with two 10μF 0805-sized ceramic capacitor ensures the minimum effective capacitance at high input voltage and high

output voltage requirement. Place these capacitors as close to the pins as possible for optimum performance and to ensure stability.

5.2.2 Feed-Forward Capacitor (C_{FF})

Although a feed-forward capacitor (C_{FF}) from the FB pin to the OUT pin is not required to achieve stability, a 10nF external feed-forward capacitor optimizes the transient, noise, and PSRR performance. A higher capacitance C_{FF} can be used; however, the start-up time is longer and the power-good signal can incorrectly indicate that the output voltage is settled.

5.3 Low-Noise, High-PSRR Output

The GD30LD3300x includes a low-noise reference and error amplifier ensuring minimal noise during operation. The NR/SS capacitor ($C_{NR/SS}$) and feed-forward capacitor (C_{FF}) are the easiest way to reduce device noise. $C_{NR/SS}$ filters the noise from the reference and C_{FF} filters the noise from the error amplifier. The noise contribution from the charge pump is minimal. The overall noise of the system at low output voltages can be reduced by using a bias rail because this rail provides more headroom for internal circuitry.

The high power-supply rejection ratio (PSRR) of the GD30LD3300x ensures minimal coupling of input supply noise to the output. The PSRR performance is primarily results from a high-bandwidth, high-gain error amplifier and an innovative circuit to boost the PSRR between 200 kHz and 1 MHz.

5.4 Power-Good Function

The PG circuit monitors the voltage at the feedback pin to indicate the status of the output voltage. The PG circuit asserts whenever FB, V_{IN} , or EN are below their thresholds. The PG operation versus the output voltage is shown in Figure 5-1, which is described by Table 5-1.

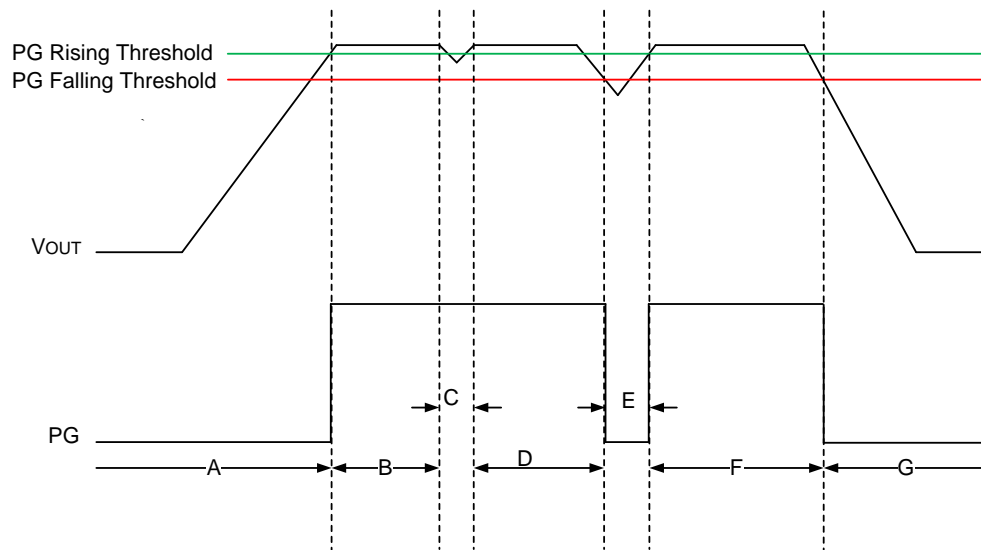
Figure 5-1 Typical PG Operation

Table 5-1 Typical PG Operation Description

Region	EVENT	PG STATUS	FB VOLTAGE
A	Turn on	0	$V_{FB} < V_{IT(PG)} + V_{HYS(PG)}$
B	Regulation	Hi-Z	$V_{FB} \geq V_{IT(PG)}$
C	Output voltage dip	Hi-Z	
D	Regulation	Hi-Z	
E	Output voltage dip	0	$V_{FB} < V_{IT(PG)}$
F	Regulation	Hi-Z	$V_{FB} \geq V_{IT(PG)}$
G	Turnoff	0	$V_{FB} < V_{IT(PG)}$

The PG pin is open-drain, and connecting a pullup resistor to an external supply enables others devices to receive Power Good as a logic signal that can be used for sequencing. Make sure that the external pullup supply voltage results in a valid logic signal for the receiving device or devices.

To ensure proper operation of the PG circuit, the pullup resistor value must be from 10 k Ω and 100 k Ω . The lower limit of 10 k Ω results from the maximum pulldown strength of the PG transistor, and the upper limit of 100 k Ω results from the maximum leakage current at the PG node. If the pullup resistor is outside of this range, then the PG signal may not read a valid digital logic level.

5.5 Soft-Start Function

The GD30LD3300x is designed for a programmable, monotonic soft-start time during the output rising, which can be achieved via an external capacitor ($C_{NR/SS}$) on NR/SS pin. Using an external $C_{NR/SS}$ is recommended for general application, it is not only for the in-rush current minimization but also helps reduce the noise component from the internal reference. During the monotonic start-up procedure, the error amplifier of the GD30LD3300x tracks the voltage ramp of the external soft-start capacitor ($C_{NR/SS}$) until the voltage approaches the internal reference 0.5V.

The soft-start ramp time can be calculated with equation, which depends on the soft-start charging current ($I_{NR/SS}$), the soft-start capacitance ($C_{NR/SS}$), and the internal reference 0.5V (V_{FB}).

$$t_{SS} = (V_{NR/SS} \times C_{NR/SS}) / I_{NR/SS}$$

For noise-reduction, $C_{NR/SS}$ in conjunction with an internal noise-reduction resistor forms a low-pass filter (LPF) and filters out the noise from the internal bandgap reference before being amplified via the error amplifier, thus reducing the total device noise floor.

5.6 Undervoltage Lockout (UVLO)

The UVLO circuits ensure that the device stays disabled before its input or bias supplies reach the minimum operational voltage range, and ensures that the device properly shuts down when either the input or bias supply collapses. Figure 5-2 and Table 5-2 explain one of the UVLO circuits being triggered to various input voltage events, assuming $V_{EN} \geq V_{IH(EN)}$.

Figure 5-2 Typical UVLO Operation

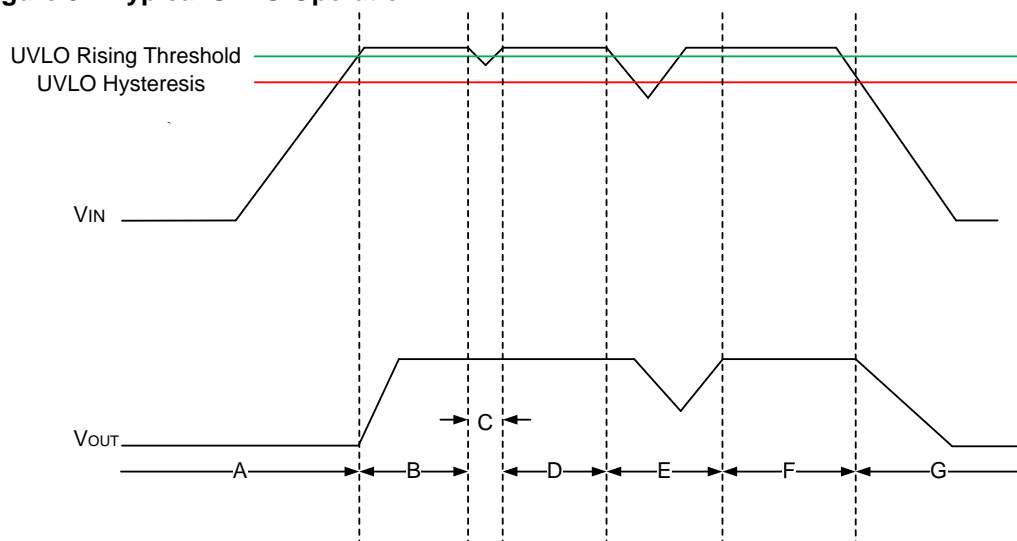

Table 5-2 Typical UVLO Operation Description

Region	EVENT	V _{OUT} STATUS	COMMENT
A	Turn on, $V_{IN} \geq V_{UVLO_1,2(IN)}$ and $V_{BIAS} \geq V_{UVLO(BIAS)}$	Off	Startup
B	Regulation	On	Regulates to target V _{OUT}
C	Brown out, $V_{IN} \geq V_{UVLO_1,2(IN)} - V_{HYS_1,2(IN)}$ or $V_{UVLO(BIAS)} - V_{HYS(BIAS)}$	On	The output can fall out of regulation but the device is still enabled
D	Regulation	On	Regulates to target V _{OUT}
E	Brown out $V_{IN} < V_{UVLO_1,2(IN)} - V_{HYS_1,2(IN)}$ or $V_{BIAS} < V_{UVLO(BIAS)} - V_{HYS(BIAS)}$	Off	The device is disabled and the output falls because of the load and active discharge circuit. The device is reenabled when the UVLO fault is removed when either the IN or BIAS UVLO rising threshold is reached by the input or bias voltage and a normal start-up then follows
F	Regulation	On	Regulates to target V _{OUT}
G	Turn off, $V_{IN} < V_{UVLO_1,2(IN)} - V_{HYS_1,2(IN)}$ or $V_{BIAS} < V_{UVLO(BIAS)} - V_{HYS(BIAS)}$	Off	The output falls because of the load and active discharge circuit.

Similar to many other LDOs with this feature, the UVLO circuits take a few microseconds to fully assert. During this time, a downward line transient below approximately 0.8V causes the UVLO to assert for a short time; however, the UVLO circuits do not have enough stored energy to fully discharge the internal circuits inside of the device. When the UVLO circuits are not given enough time to fully discharge the internal nodes, the outputs are not fully disabled.

The effect of the downward line transient can be mitigated by using a larger input capacitor to increase the fall time of the input supply when operating near the minimum V_{IN}.

5.7 Power Dissipation (P_D)

Circuit reliability demands that proper consideration is given to device power dissipation, location of the circuit on the printed circuit board (PCB), and correct sizing of the thermal plane. The PCB area around the regulator must be as free as possible of other heat-generating devices that cause added thermal stresses.

Power dissipation in the regulator depends on the input-to-output voltage difference and load

conditions.

$$P_D = (V_{IN} - V_{OUT}) \times I_{OUT} + V_{IN} \times I_{GND}$$

$V_{IN} \times I_{GND}$ represents the static power consumption of the LDO, the value is relatively small and can be ignored. An important note is that power dissipation can be minimized, and thus greater efficiency achieved, by proper selection of the system voltage rails. Proper selection allows the minimum input-to-output voltage differential to be obtained. The low dropout of the device allows for maximum efficiency across a wide range of output voltages.

The main heat conduction path for the device is through the thermal pad on the package. As such, the thermal pad must be soldered to a copper pad area under the device. This pad area contains an array of plated vias that conduct heat to any inner plane areas or to a bottom-side copper plane.

The maximum power dissipation determines the maximum allowable junction temperature (T_J) for the device. Power dissipation and junction temperature are most often related by the junction-to-ambient thermal resistance (θ_{JA}) of the combined PCB, device package, and the temperature of the ambient air (T_A).

$$T_J = T_A + \theta_{JA} \times P_D$$

$$I_{OUT} = (T_J - T_A) / [\theta_{JA} \times (V_{IN} - V_{OUT})]$$

6 Electrical characteristics

6.1 Absolute maximum ratings

The maximum ratings are the limits to which the device can be subjected without permanently damaging the device. Note that the device is not guaranteed to operate properly at the maximum ratings. Exposure to the absolute maximum rating conditions for extended periods may affect device reliability.

Table 6-1 Absolute maximum ratings

Symbol	Parameter	Min	Max	Unit
Voltage	IN, BIAS, PG, EN, OUT	-0.3	7.0	V
	NR/SS, FB	-0.3	3.6	V
Current	OUT	Internally limited	Internally limited	A
	PG(sink current into device)	—	5	mA
Thermal characteristics				
T _J	Operating junction temperature	-55	150	°C
T _{stg}	Storage temperature	-65	150	°C

6.2 Recommended Operating Conditions

Table 6-2 Recommended Operating Conditions

Symbol	Parameter	Min	Typ	Max	Unit
V _{IN}	Input voltage range	1.1	—	6.5	V
V _{BIAS}	Bias supply voltage range	3.0	—	6.5	V
V _{OUT}	Output voltage range	0.5	—	5.2	V
V _{EN}	Enable Voltage range	0	—	V _{IN}	V
I _{OUT}	Output current	0	—	3	A
C _{IN}	Input capacitor	10	47	—	uF
C _{OUT}	Output capacitor	47	47 // 10 // 10	—	uF
R _{PG}	Power-good pullup resistance	10	—	100	kΩ

Symbol	Parameter	Min	Typ	Max	Unit
C _{NR/SS}	NR/SS capacitor	—	10	—	nF
C _{FF}	Feed-forward capacitor	—	10	—	nF
R ₁	Adjustable resistance in FB network	—	12.1	—	kΩ
R ₂	Adjustable resistance in FB network	—	—	160	kΩ
T _J	Operating junction temperature	-40	—	125	°C

6.3 Electrical sensitivity

The device is strained in order to determine its performance in terms of electrical sensitivity. Electrostatic discharges (ESD) are applied directly to the pins of the sample.

Table 6-3 Electrostatic Discharge characteristics

Symbol	Parameter	Conditions	Value	Unit
V _{ESD(HBM)}	Electrostatic discharge voltage (human body model)	T _A = 25 °C; JS-001-2017	±2000	V
V _{ESD(CDM)}	Electrostatic discharge voltage (charge device model)	T _A = 25 °C; JS-002-2018	±500	V

6.4 Electrical Specifications

Over operating temperature range (T_J = -40°C to 125°C), Typical values are at T_J = 25°C. V_{IN} = 1.4 V or V_{IN} = V_{OUT (TARGET)} + 0.4 V, V_{BIAS}=OPEN, V_{OUT (TARGET)} = 0.5 V, V_{OUT} connected to 50 Ω to GND, V_{EN} = 1.1 V, C_{IN} = 10 μF, C_{OUT} = 47 μF, C_{NR/SS} = 0 nF, C_{FF} = 0 nF, and PG pin pulled up to OUT with 100 kΩ, unless otherwise noted.

Table 6-4 Electrical characteristics

Symbol	Parameter	Conditions	Min	Typ	Max	Unit
V _{IN}	Input Range	—	1.1	—	6.5	V
V _{BIAS}	BIAS Range	V _{IN} = 1.1 V	3.0	—	6.5	V
V _{FB}	Feedback Voltage	—	—	0.5	—	V
V _{NR/SS}	NR/SS pin Voltage	—	—	0.5	—	V
V _{UVLO1(IN)}	UVLO1 with BIAS	V _{IN} rising with V _{BIAS} = 3.0 V	—	0.93	1.085	V
V _{HYS1(IN)}	UVLO1 hysteresis With	V _{BIAS} = 3.0 V	—	240	—	mV

Symbol	Parameter	Conditions	Min	Typ	Max	Unit
	BIAS					
$V_{UVLO2(IN)}$	UVLO2 without BIAS	V_{IN} rising	—	1.33	1.39	V
$V_{HYS2(IN)}$	UVLO2 hysteresis without BIAS	—	—	230	—	mV
$V_{UVLO(BIAS)}$	UVLO(BIAS)	V_{BIAS} rising, $V_{IN} = 1.1$ V	—	2.72	2.9	V
$V_{HYS(BIAS)}$	UVLO(BIAS) hysteresis With BIAS	$V_{IN} = 1.1$ V	—	250	—	mV
V_{OUT}	Output Voltage Range	Using Voltage setting pins (25 mV, 50 mV, 100 mV, 200 mV, 400 mV and 0.8 V)	0.5 -1%	—	2.075 +1%	V
		Using external resistors	0.5 -1%	—	5.2 +1%	V
	Output Accuracy	$V_{IN} = V_{OUT} + 0.3$ V, 0.5 V $\leq V_{OUT} \leq 5.2$ V	-1	—	1	%
$\frac{\Delta V_{OUT}}{\Delta V_{IN}}$	Line Regulation	$I_{OUT} = 5$ mA, 1.4 V $\leq V_{IN} \leq 6.5$ V	—	0.1	—	mV/V
$\frac{\Delta V_{OUT}}{\Delta I_{OUT}}$	Load Regulation	5 mA $\leq I_{OUT} \leq 3$ A	—	0.3	—	mV/A
V_{DROP}	Dropout Voltage	$V_{IN} = 1.4$ V, $I_{OUT} = 3$ A, $V_{FB} = 0.5$ V – 3%	—	135	250	mV
		$V_{IN} = 5.4$ V, $I_{OUT} = 3$ A, $V_{FB} = 0.5$ V – 3%	—	155	250	mV
		$V_{IN} = 1.1$ V, $V_{BIAS} = 5$ V, $I_{OUT} = 3$ A, $V_{FB} = 0.5$ V – 3%	—	110	180	mV
I_{LIM}	Output Current Limit	$V_{OUT} = 90\% * V_{OUT(TARGET)}$ $V_{IN} = V_{OUT(TARGET)} + 400$ mV	3.7	4.2	4.7	A
I_{SC}	Short-Circuit Current Limit	$R_{LOAD} = 20$ m Ω	—	1	—	A
I_{GND}	Ground Pin Current	$V_{IN} = 6.5$ V, $I_{OUT} = 5$ mA	—	3.0	4.2	mA
		$V_{IN} = 1.4$ V, $I_{OUT} = 3$ A	—	4.2	5.5	mA
		Shutdown, PG = OPEN, $V_{IN} = 6.5$ V, $V_{EN} = 0.5$ V	—	—	25	μ A
I_{BIAS}	BIAS Pin Current	$V_{IN} = 1.1$ V, $V_{BIAS} = 6.5$ V, $V_{OUT} = 0.5$ V, $I_{OUT} = 3$ A	—	3.0	4.2	mA
I_{EN}	EN Pin Current	$V_{IN} = 6.5$ V, $V_{EN} = 0$ V and 6.5 V	-0.1	—	0.1	μ A
V_{EN_H}	EN Pin High-Level	—	1.1	—	6.5	V
V_{EN_L}	EN Pin	—	0	—	0.5	V

Symbol	Parameter	Conditions	Min	Typ	Max	Unit	
	Low-Level						
$V_{IT(PG)}$	PG Pin Threshold	For falling V_{OUT}	81% * V_{OUT}	86% * V_{OUT}	91% * V_{OUT}	V	
V_{HYS_PG}	PG Pin Hysteresis	For rising V_{OUT}	—	6% * V_{OUT}	—	V	
V_{PG_L}	PG Pin Low-Level output Voltage	$V_{OUT} < V_{IT(PG)}$, $I_{PG} = -1 \text{ mA}$	—	—	0.1	V	
I_{PG_LK}	PG Pin Low-leakage Current	$V_{OUT} > V_{IT(PG)}$, $V_{PG} = 6.5 \text{ V}$	—	—	1	μA	
$I_{NR/SS}$	NR/SS Pin Charging Current	$V_{IN} = \text{GND}$, $V_{IN} = 6.5 \text{ V}$	4	7.2	9	μA	
I_{FB}	FB Pin leakage Current	$V_{IN} = 6.5 \text{ V}$	-100	—	100	nA	
PSRR	Power Supply Ripple Rejection	$V_{IN}-V_{OUT} = 0.4 \text{ V}$ $I_{OUT} = 3 \text{ A}$ $C_{NR/SS} = 100 \text{ nF}$ $C_{FF} = 10 \text{ nF}$ $C_{OUT} = 47\mu\text{F}/10\mu\text{F}/10\mu\text{F}$	$f = 10 \text{ KHz}$, $V_{OUT}=0.8 \text{ V}$ $V_{BIAS} = 5 \text{ V}$	—	42	—	dB
			$f = 500\text{KHz}$, $V_{OUT}=0.8 \text{ V}$ $V_{BIAS} = 5\text{V}$	—	39	—	dB
			$f = 10 \text{ KHz}$, $V_{OUT} = 5 \text{ V}$	—	40	—	dB
			$f = 500 \text{ KHz}$, $V_{OUT}=5 \text{ V}$	—	25	—	dB
V_N	Output Noise Voltage	$BW = 10 \text{ Hz to } 100 \text{ KHz}$, $V_{in} = 1.1 \text{ V}$ $V_{OUT} = 0.5 \text{ V}$, $V_{BIAS} = 5 \text{ V}$, $I_{OUT} = 3 \text{ A}$, $C_{NR/SS} = 100 \text{ nF}$, $C_{FF} = 10 \text{ nF}$ $C_{OUT} = 47 \mu\text{F}/10 \mu\text{F}/10 \mu\text{F}$	—	5.9	—	μVRMS	
			$BW = 10 \text{ Hz to } 100 \text{ KHz}$, $V_{OUT} = 5.0 \text{ V}$, $I_{OUT} = 3 \text{ A}$, $C_{NR/SS} = 100 \text{ nF}$, $C_{FF} = 10 \text{ nF}$ $C_{OUT} = 47 \mu\text{F}/10 \mu\text{F}/10 \mu\text{F}$	—	9.8	—	μVRMS
T_{SD}	Thermal Shutdown Threshold	Shut down, temperature increasing	—	160	—	$^{\circ}\text{C}$	
		Reset, temperature increasing	—	140	—	$^{\circ}\text{C}$	

6.5 Typical Characteristics

$T_A = 25^\circ\text{C}$, $V_{IN} = 1.4\text{ V}$ or $V_{IN} = V_{OUT(NOM)} + 0.4\text{ V}$ (whichever is greater), $V_{BIAS} = \text{OPEN}$, $V_{OUT(NOM)} = 0.8\text{ V}$, $V_{EN} = 1.1\text{ V}$, $C_{OUT} = 47\ \mu\text{F} // 10\ \mu\text{F} // 10\ \mu\text{F}$, $C_{NR/SS} = 10\ \text{nF}$, $C_{FF} = 10\ \text{nF}$, and PG pin pulled up to V_{IN} with $100\ \text{k}\Omega$ (unless otherwise noted).

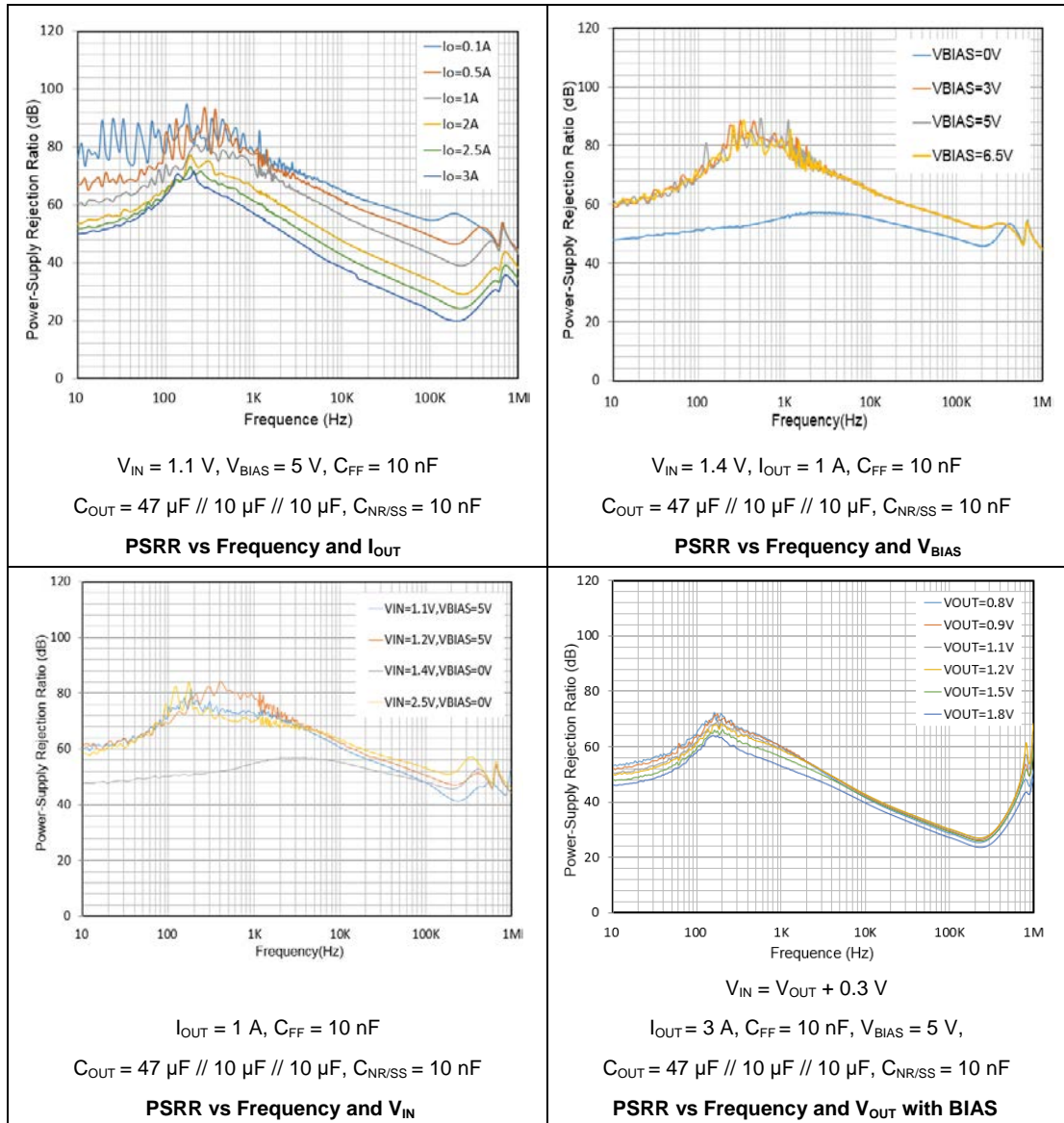

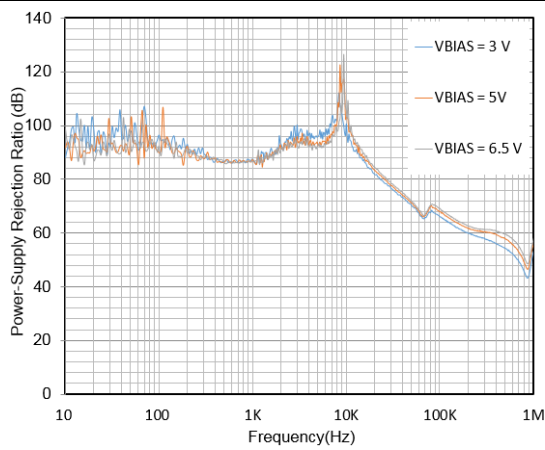

$V_{IN} = V_{OUT} + 0.3 \text{ V}$, $I_{OUT} = 3 \text{ A}$, $V_{OUT} = 1 \text{ V}$,
 $C_{OUT} = 47 \mu\text{F} // 10 \mu\text{F} // 10 \mu\text{F}$, $C_{NR/SS} = 10 \text{ nF}$
 $C_{FF} = 10 \text{ nF}$

V_{BIAS} PSRR vs Frequency

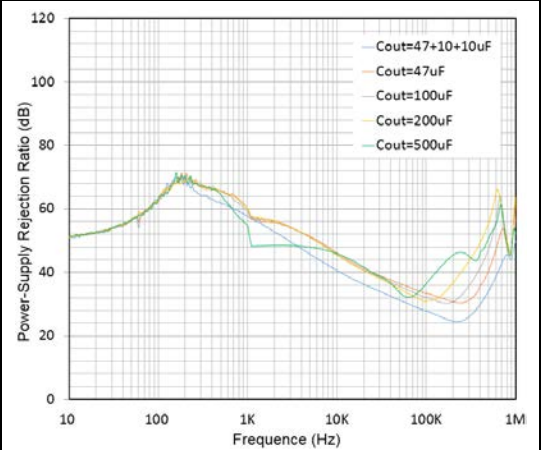

$V_{IN} = 1.4 \text{ V}$, $V_{BIAS} = 5 \text{ V}$, $V_{OUT} = 1 \text{ V}$, $I_{OUT} = 3 \text{ A}$
 $C_{OUT} = 47 \mu\text{F} // 10 \mu\text{F} // 10 \mu\text{F}$, $C_{NR/SS} = 10 \text{ nF}$,
 $C_{FF} = 10 \text{ nF}$

PSRR vs Frequency and C_{OUT}

Typical Characteristics

$T_A = 25^\circ\text{C}$, $V_{IN} = 1.4\text{ V}$ or $V_{IN} = V_{OUT(NOM)} + 0.4\text{ V}$ (whichever is greater), $V_{BIAS} = \text{OPEN}$, $V_{OUT(NOM)} = 0.8\text{ V}$, $V_{EN} = 1.1\text{ V}$, $C_{OUT} = 47\text{ }\mu\text{F} // 10\text{ }\mu\text{F} // 10\text{ }\mu\text{F}$, $C_{NR/SS} = 10\text{ nF}$, $C_{FF} = 10\text{ nF}$, and PG pin pulled up to V_{IN} with $100\text{ k}\Omega$ (unless otherwise noted).

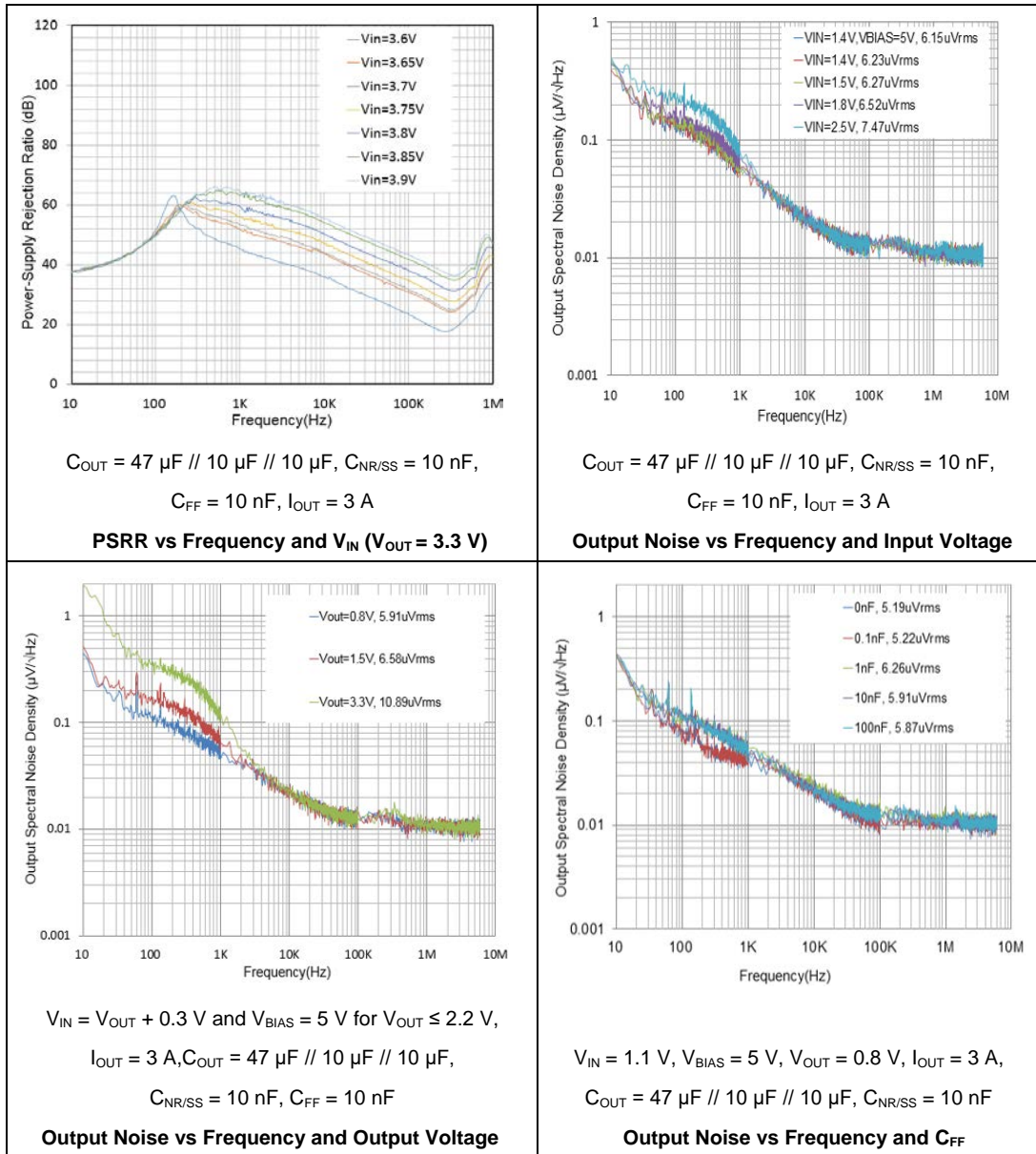

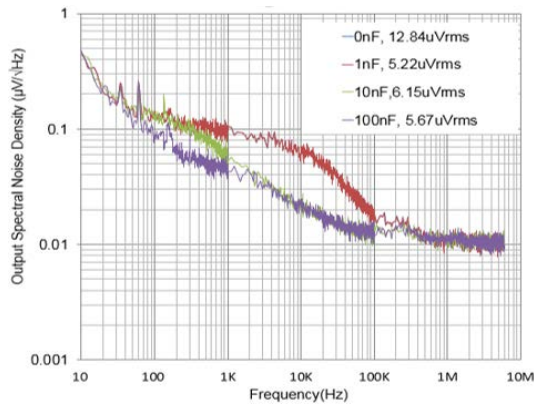

$V_{IN} = 1.1\text{ V}$, $V_{BIAS} = 5\text{ V}$, $V_{OUT} = 0.8\text{ V}$, $I_{OUT} = 3\text{ A}$,

$C_{OUT} = 47\text{ }\mu\text{F} // 10\text{ }\mu\text{F} // 10\text{ }\mu\text{F}$, $C_{FF} = 10\text{ nF}$

Output Noise vs Frequency and $C_{NR/SS}$

Typical Characteristics

$T_A = 25^\circ\text{C}$, $V_{IN} = 1.4\text{ V}$ or $V_{IN} = V_{OUT(NOM)} + 0.4\text{ V}$ (whichever is greater), $V_{BIAS} = \text{OPEN}$, $V_{OUT(NOM)} = 0.5\text{ V}$, $V_{EN} = 1.1\text{ V}$, $C_{OUT} = 47\text{ }\mu\text{F} // 10\text{ }\mu\text{F} // 10\text{ }\mu\text{F}$, $C_{NR/SS} = 10\text{ nF}$, $C_{FF} = 10\text{ nF}$, and PG pin pulled up to V_{IN} with $100\text{ k}\Omega$ (unless otherwise noted).

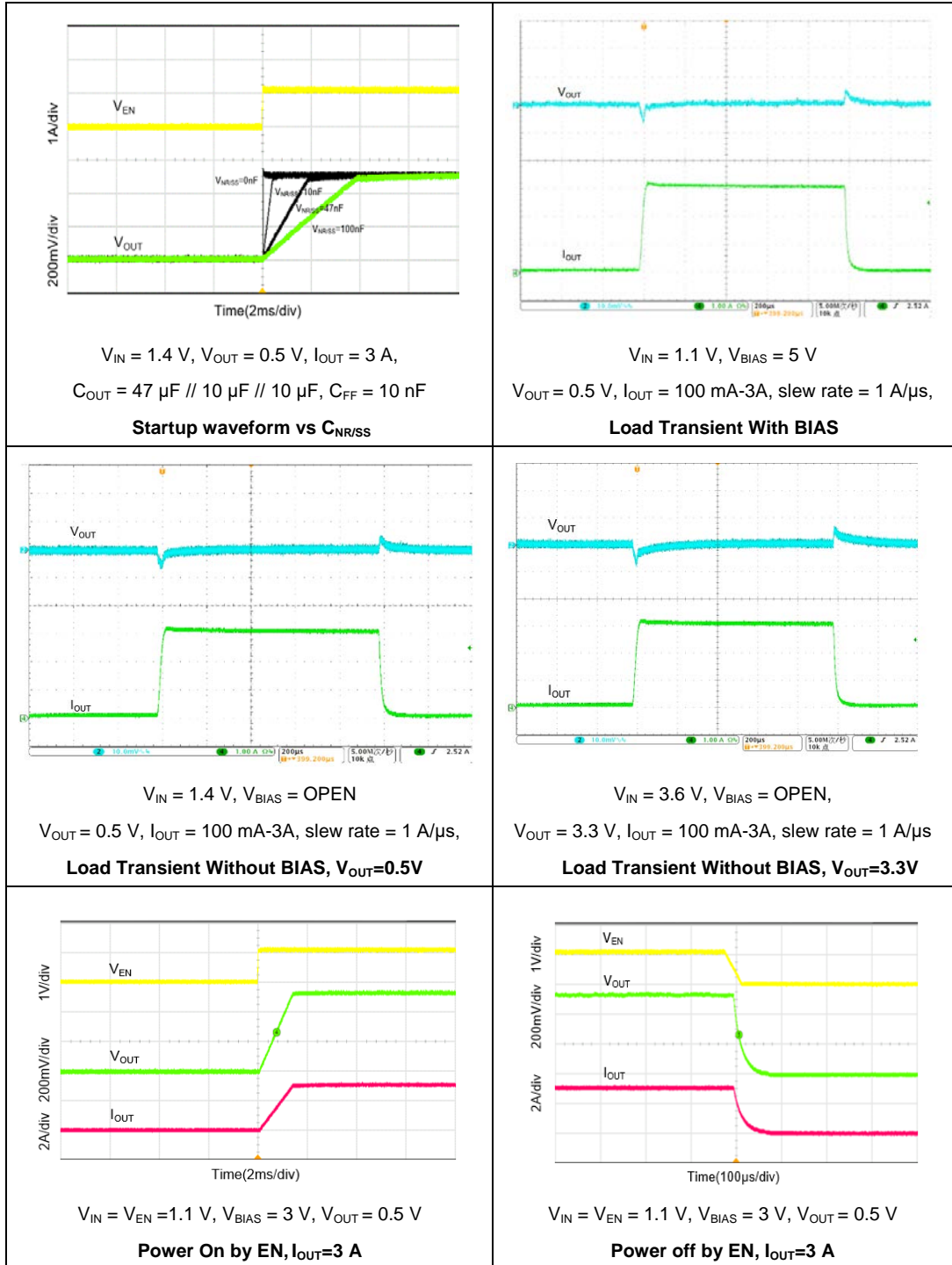

Typical Characteristics

$T_A = 25^\circ\text{C}$, $V_{IN} = 1.4\text{ V}$ or $V_{IN} = V_{OUT(NOM)} + 0.4\text{ V}$ (whichever is greater), $V_{BIAS} = \text{OPEN}$, $V_{OUT(NOM)} = 0.5\text{ V}$, $V_{EN} = 1.1\text{ V}$, $C_{OUT} = 47\text{ uF} // 10\text{ }\mu\text{F} // 10\text{ }\mu\text{F}$, $C_{NR/SS} = 10\text{ nF}$, $C_{FF} = 10\text{ nF}$, and PG pin pulled up to V_{IN} with $100\text{ k}\Omega$ (unless otherwise noted).

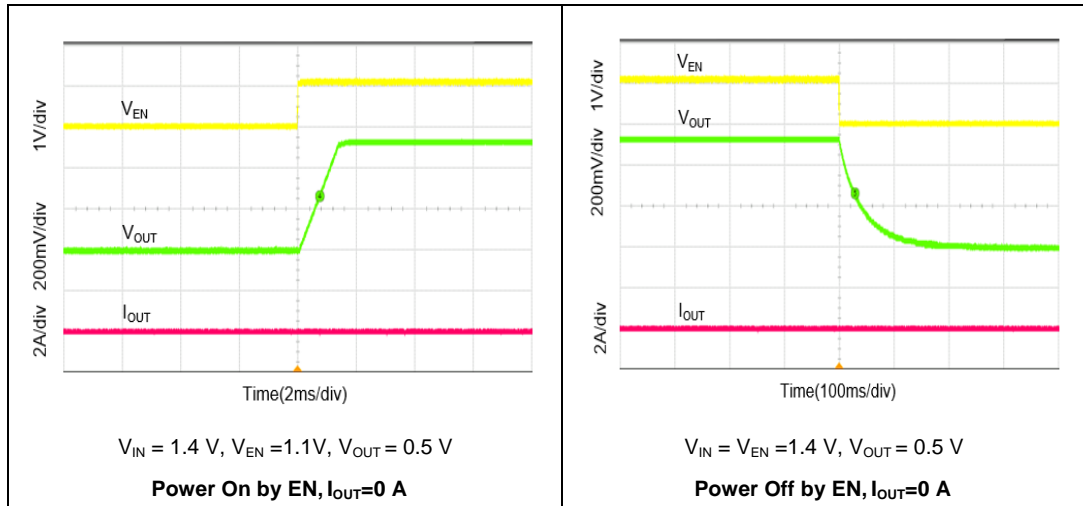

Typical Characteristics

$T_A = 25^\circ\text{C}$, $V_{IN} = 1.4\text{ V}$ or $V_{IN} = V_{OUT(NOM)} + 0.4\text{ V}$ (whichever is greater), $V_{BIAS} = \text{OPEN}$, $V_{OUT(NOM)} = 0.5\text{ V}$, $V_{EN} = 1.1\text{ V}$, $C_{OUT} = 47\text{ }\mu\text{F} // 10\text{ }\mu\text{F} // 10\text{ }\mu\text{F}$, $C_{NR/SS} = 10\text{ nF}$, $C_{FF} = 10\text{ nF}$, and PG pin pulled up to V_{IN} with $100\text{ k}\Omega$ (unless otherwise noted).

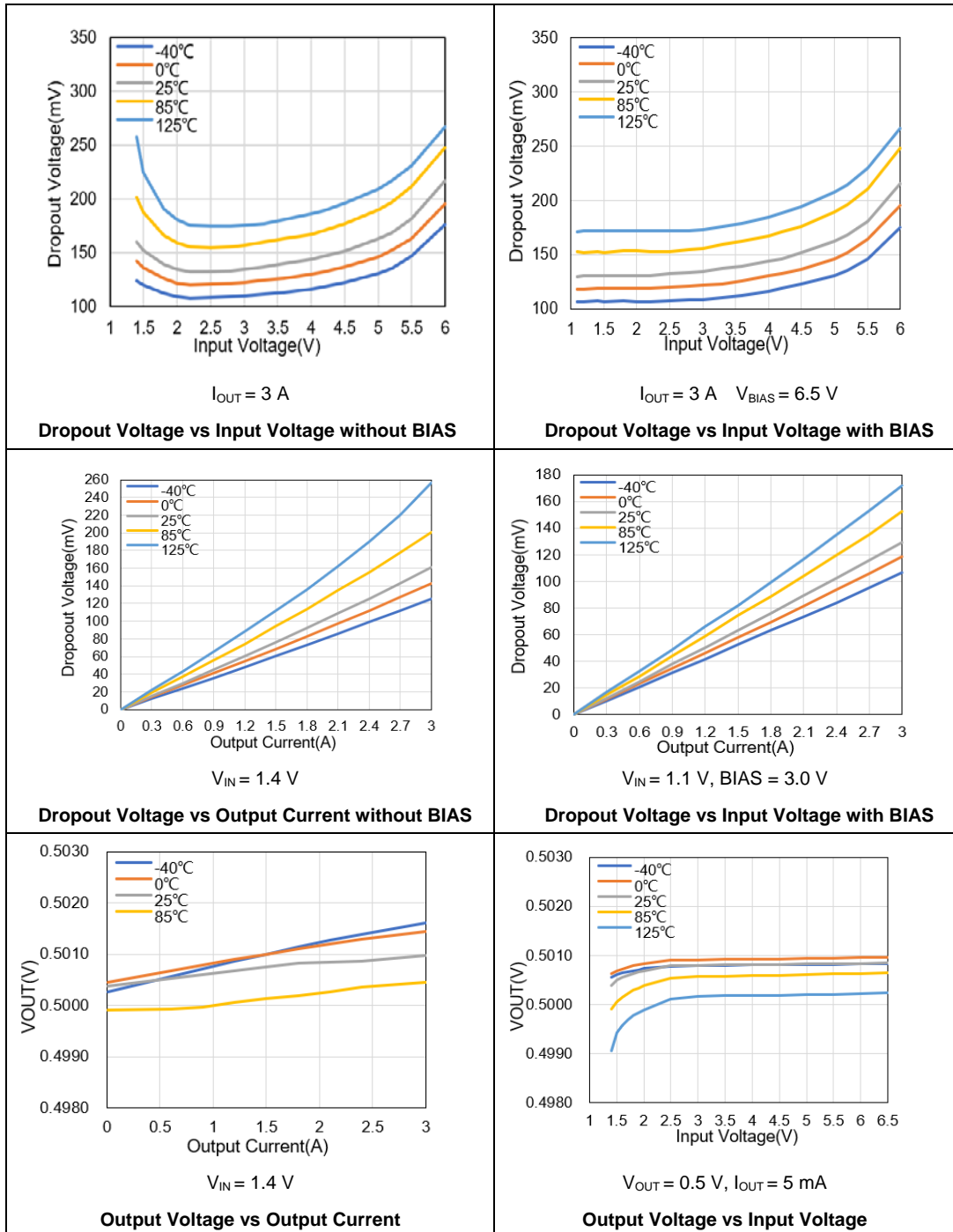

Typical Characteristics

$T_A = 25^\circ\text{C}$, $V_{IN} = 1.4\text{ V}$ or $V_{IN} = V_{OUT(NOM)} + 0.4\text{ V}$ (whichever is greater), $V_{BIAS} = \text{OPEN}$, $V_{OUT(NOM)} = 0.5\text{ V}$, $V_{EN} = 1.1\text{ V}$, $C_{OUT} = 47\text{ }\mu\text{F} // 10\text{ }\mu\text{F} // 10\text{ }\mu\text{F}$, $C_{NR/SS} = 10\text{ nF}$, $C_{FF} = 10\text{ nF}$, and PG pin pulled up to V_{IN} with $100\text{ k}\Omega$ (unless otherwise noted).

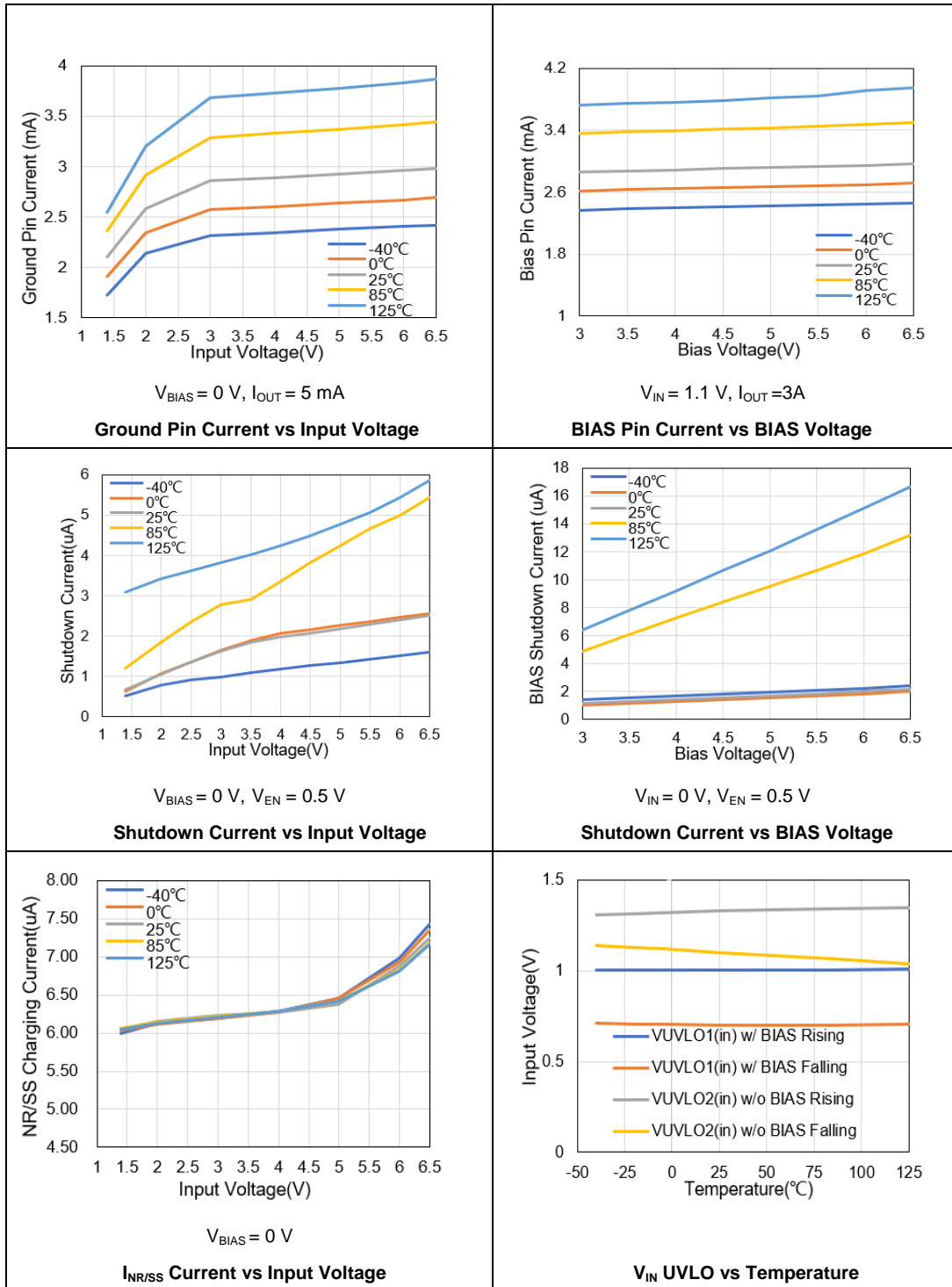

Typical Characteristics

$T_A = 25^\circ\text{C}$, $V_{IN} = 1.4\text{ V}$ or $V_{IN} = V_{OUT(NOM)} + 0.4\text{ V}$ (whichever is greater), $V_{BIAS} = \text{OPEN}$, $V_{OUT(NOM)} = 0.5\text{ V}$, $V_{EN} = 1.1\text{ V}$, $C_{OUT} = 47\text{ }\mu\text{F} // 10\text{ }\mu\text{F} // 10\text{ }\mu\text{F}$, $C_{NR/SS} = 10\text{ nF}$, $C_{FF} = 10\text{ nF}$, and PG pin pulled up to V_{IN} with $100\text{ k}\Omega$ (unless otherwise noted).

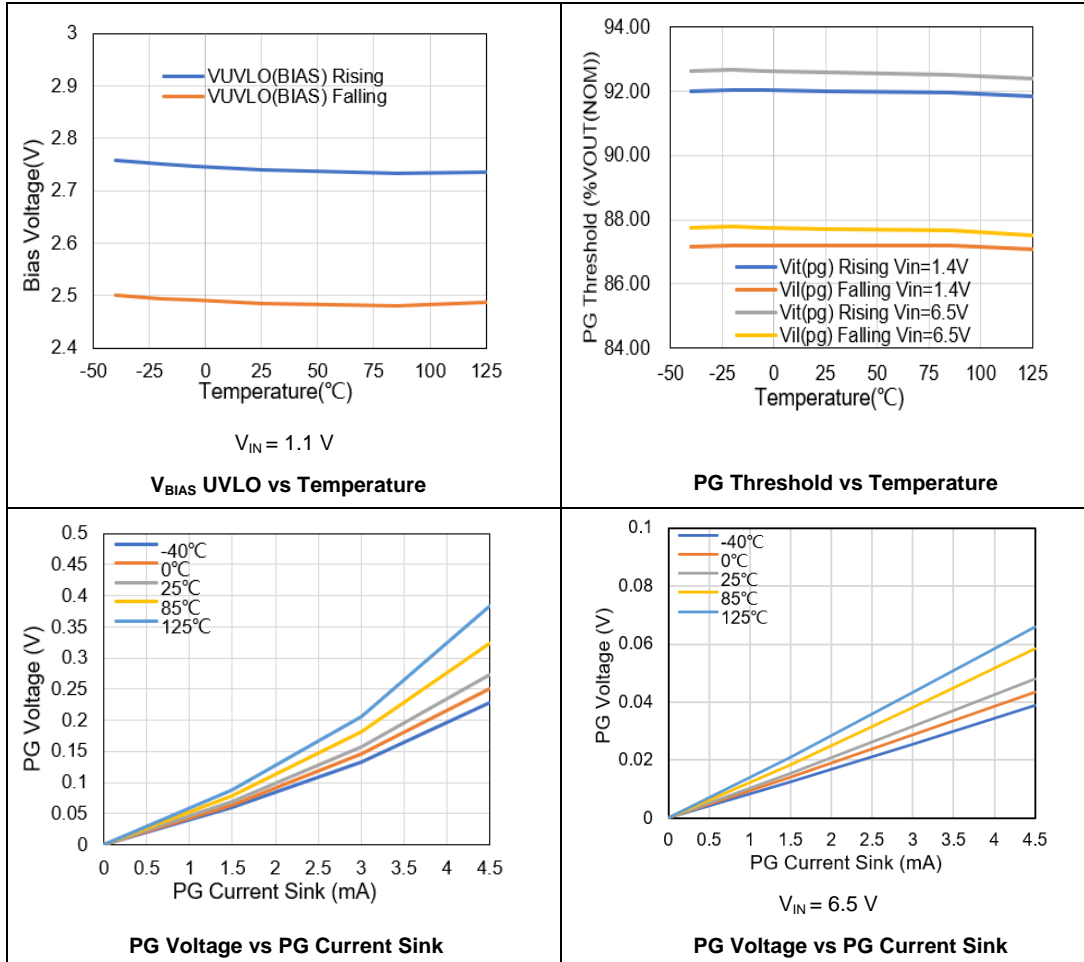

7 Typical application circuit

Figure 7-1 Typical GD30LD3300x application circuit with adjustable resistance

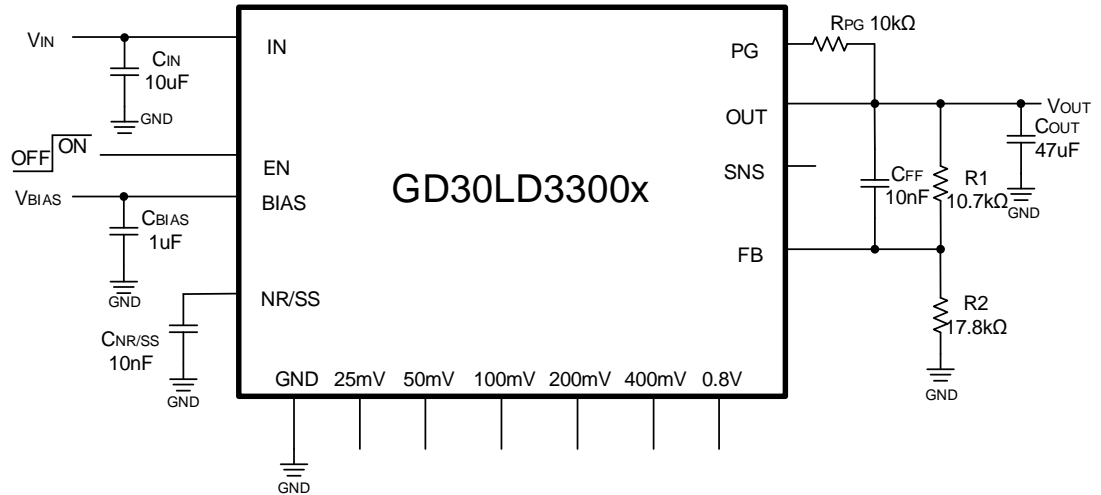
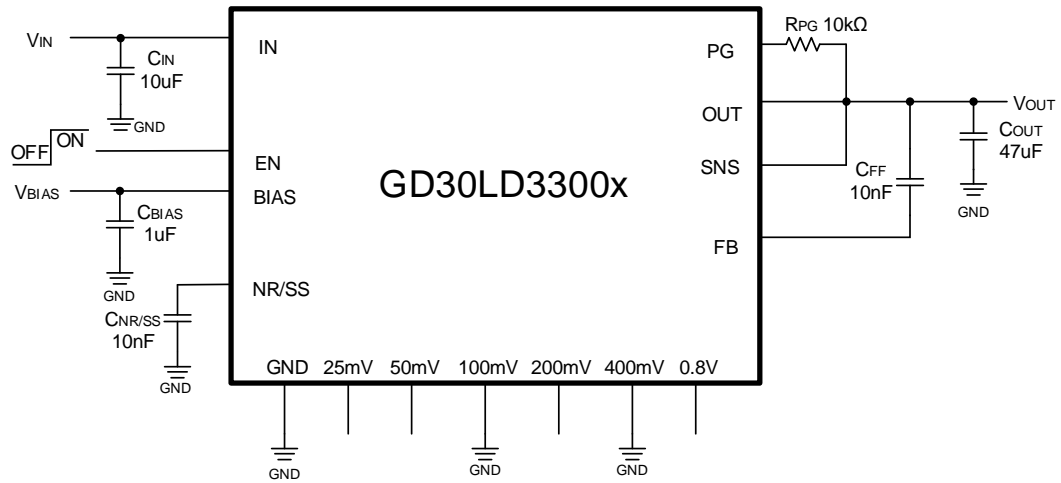

Table 7-1 Adjusted V_{OUT} by external feedback resistor

$V_{OUT}(V)$	External Feedback Resistor	
	R1 (kΩ)	R2(kΩ)
0.5	0	NC
0.6	11	54.9
0.7	10.2	25.5
0.8	10.7	17.8
0.9	11	13.7
1.0	11	11
1.2	9.31	6.65
1.8	10.2	3.92
2.5	10.8	2.7
3.0	11	2.2
3.3	11.2	2
5.0	10.8	1.2
5.2	12.22	1.3

Figure 7-2 Typical GD30LD3300x application circuit with pin-setting



1.0V Fixed V_{OUT} (V_{OUT} = V_{FB} + 100mV + 400mV = 1.0V)

Table 7-2 Adjusted V_{OUT} by pin-setting

V _{FB} = 0.5V, SNS connect to V _{OUT}						
V _{out} (V)	25mV	50mV	100mV	200mV	400mV	0.8V
0.500	OPEN	OPEN	OPEN	OPEN	OPEN	OPEN
0.525	GND	OPEN	OPEN	OPEN	OPEN	OPEN
0.550	OPEN	GND	OPEN	OPEN	OPEN	OPEN
0.575	GND	GND	OPEN	OPEN	OPEN	OPEN
0.600	OPEN	OPEN	GND	OPEN	OPEN	OPEN
0.625	GND	OPEN	GND	OPEN	OPEN	OPEN
0.650	OPEN	GND	GND	OPEN	OPEN	OPEN
0.675	GND	GND	GND	OPEN	OPEN	OPEN
0.700	OPEN	OPEN	OPEN	GND	OPEN	OPEN
0.725	GND	OPEN	OPEN	GND	OPEN	OPEN
0.750	OPEN	GND	OPEN	GND	OPEN	OPEN
0.775	GND	GND	OPEN	GND	OPEN	OPEN
0.800	OPEN	OPEN	GND	GND	OPEN	OPEN
0.825	GND	OPEN	GND	GND	OPEN	OPEN
0.850	OPEN	GND	GND	GND	OPEN	OPEN
0.875	GND	GND	GND	GND	OPEN	OPEN
0.900	OPEN	OPEN	OPEN	OPEN	GND	OPEN
0.925	GND	OPEN	OPEN	OPEN	GND	OPEN
0.950	OPEN	GND	OPEN	OPEN	GND	OPEN
0.975	GND	GND	OPEN	OPEN	GND	OPEN
1.000	OPEN	OPEN	GND	OPEN	GND	OPEN
1.025	GND	OPEN	GND	OPEN	GND	OPEN
1.050	OPEN	GND	GND	OPEN	GND	OPEN
1.075	GND	GND	GND	OPEN	GND	OPEN
1.100	OPEN	OPEN	OPEN	GND	GND	OPEN

V_{FB} = 0.5V, SNS connect to V_{OUT}						
V_{OUT}(V)	25mV	50mV	100mV	200mV	400mV	0.8V
1.125	GND	OPEN	OPEN	GND	GND	OPEN
1.150	OPEN	GND	OPEN	GND	GND	OPEN
1.175	GND	GND	OPEN	GND	GND	OPEN
1.200	OPEN	OPEN	GND	GND	GND	OPEN
1.225	GND	OPEN	GND	GND	GND	OPEN
1.250	OPEN	GND	GND	GND	GND	OPEN
1.275	GND	GND	GND	GND	GND	OPEN
1.300	OPEN	OPEN	OPEN	OPEN	OPEN	GND
1.325	GND	OPEN	OPEN	OPEN	OPEN	GND
1.350	OPEN	GND	OPEN	OPEN	OPEN	GND
1.375	GND	GND	OPEN	OPEN	OPEN	GND
1.400	OPEN	OPEN	GND	OPEN	OPEN	GND
1.425	GND	OPEN	GND	OPEN	OPEN	GND
1.450	OPEN	GND	GND	OPEN	OPEN	GND
1.475	GND	GND	GND	OPEN	OPEN	GND
1.500	OPEN	OPEN	OPEN	GND	OPEN	GND
1.525	GND	OPEN	OPEN	GND	OPEN	GND
1.550	OPEN	GND	OPEN	GND	OPEN	GND
1.575	GND	GND	OPEN	GND	OPEN	GND
1.600	OPEN	OPEN	GND	GND	OPEN	GND
1.625	GND	OPEN	GND	GND	OPEN	GND
1.650	OPEN	GND	GND	GND	OPEN	GND
1.675	GND	GND	GND	GND	OPEN	GND
1.700	OPEN	OPEN	OPEN	OPEN	GND	GND
1.725	GND	OPEN	OPEN	OPEN	GND	GND
1.750	OPEN	GND	OPEN	OPEN	GND	GND
1.775	GND	GND	OPEN	OPEN	GND	GND
1.800	OPEN	OPEN	GND	OPEN	GND	GND
1.825	GND	OPEN	GND	OPEN	GND	GND
1.850	OPEN	GND	GND	OPEN	GND	GND
1.875	GND	GND	GND	OPEN	GND	GND
1.900	OPEN	OPEN	OPEN	GND	GND	GND
1.925	GND	OPEN	OPEN	GND	GND	GND
1.950	OPEN	GND	OPEN	GND	GND	GND
1.975	GND	GND	OPEN	GND	GND	GND
2.000	OPEN	OPEN	GND	GND	GND	GND
2.025	GND	OPEN	GND	GND	GND	GND
2.050	OPEN	GND	GND	GND	GND	GND
2.075	GND	GND	GND	GND	GND	GND

8 Layout guideline

Figure 8-1 Typical GD30LD3300x layout guideline

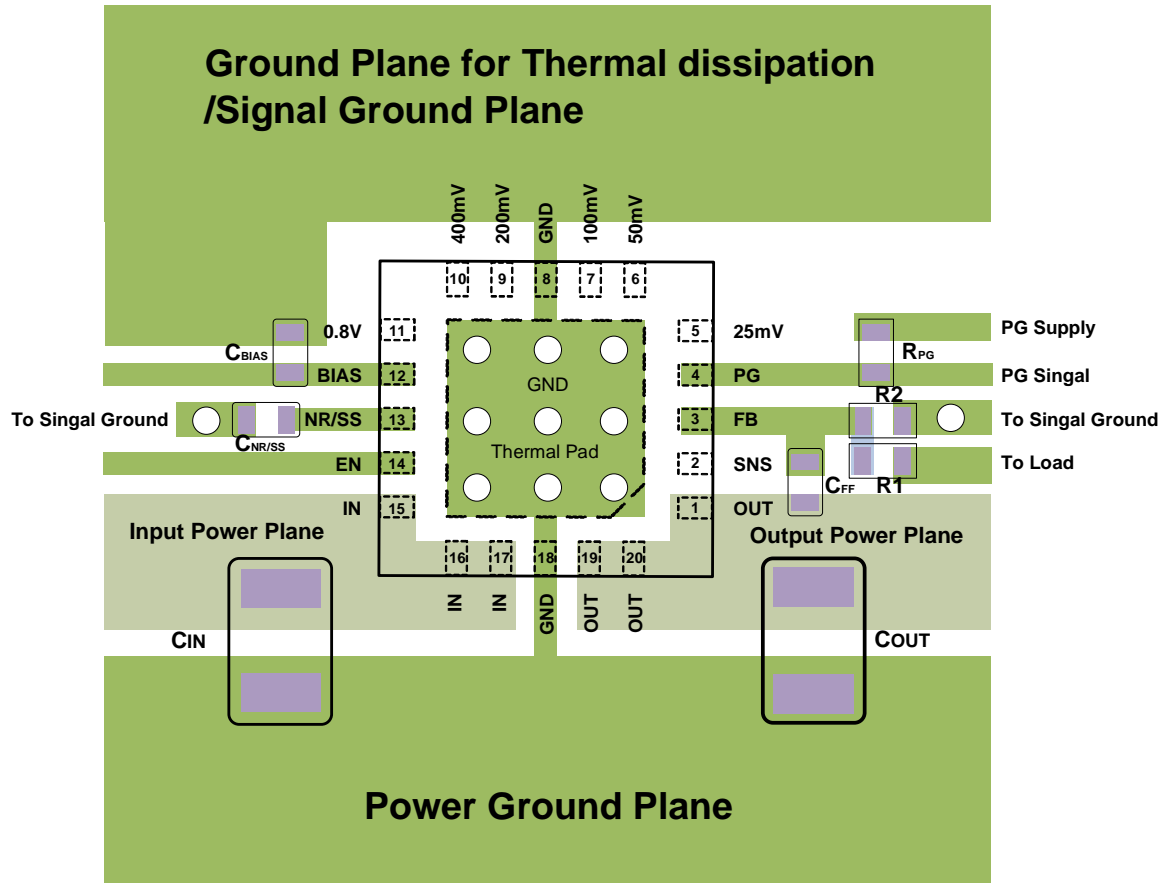

Notes:

1. The capacitor C_{IN} and C_{OUT} should be placed on the top layer to reduce parasitic parameters.
2. All capacitors are as close as possible to the corresponding pins of the LDO.

9 Package information

9.1 QFN20 package outline dimensions

Figure 9-1 QFN20 package outline

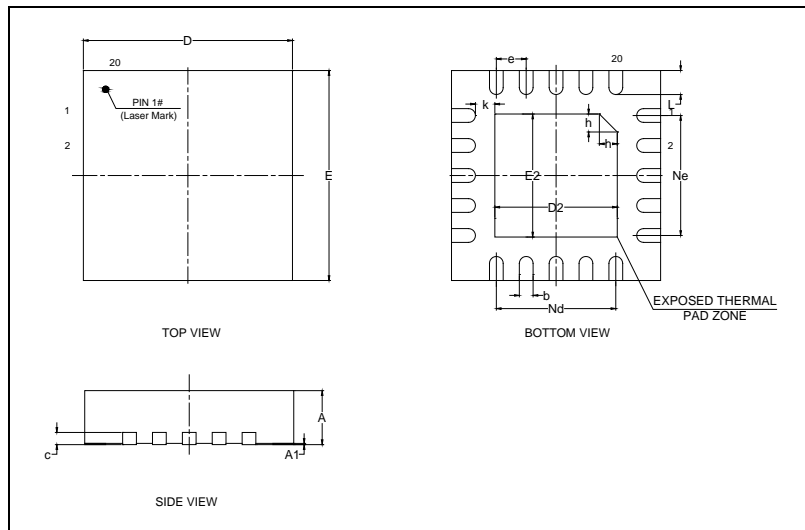
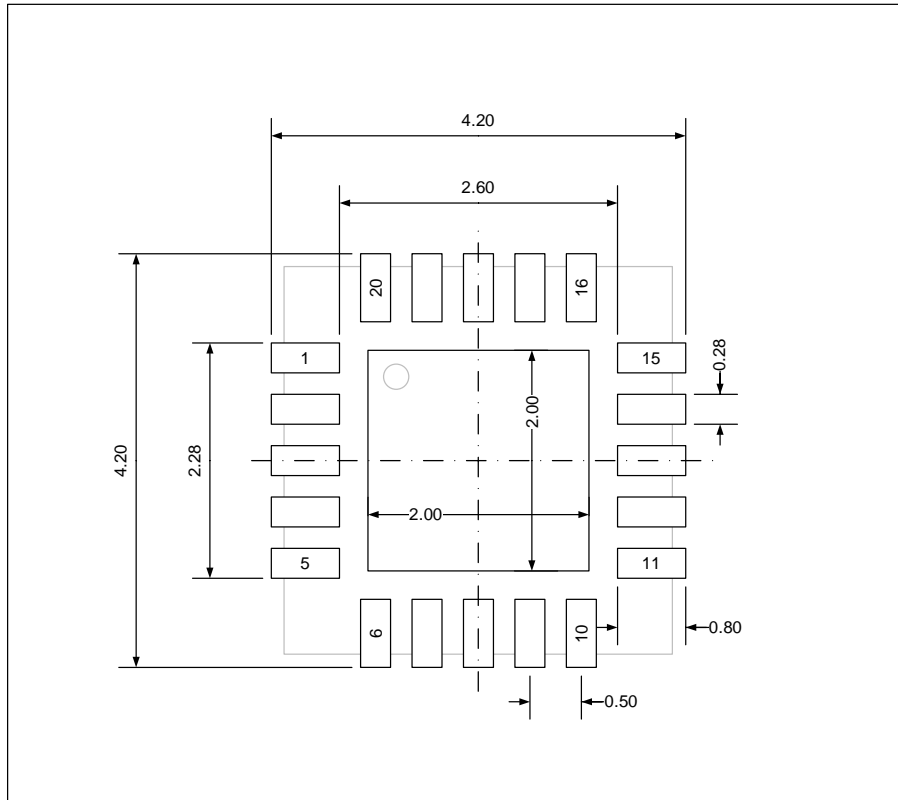

Table 9-1 QFN20 dimensions

Symbol	Min	Typ	Max
A	0.70	0.75	0.80
A1	0	0.02	0.05
b	0.18	0.23	0.30
c	—	0.203	—
D	3.40	3.50	3.60
D2	1.95	2.05	2.15
E	3.40	3.50	3.60
E2	1.95	2.05	2.15
e	—	0.50	—
h	0.25	0.30	0.35
K	0.275	0.325	0.375
L	0.35	0.40	0.45
Nd	—	2.00	—
Ne	—	2.00	—

(Original dimensions are in millimeters)

Figure 9-2 QFN20 recommend footprint



(All dimensions are in millimeters)

9.2 Thermal characteristics

Thermal resistance is used to characterize the thermal performance of the package device, which is represented by the Greek letter “ Θ ”. For semiconductor devices, thermal resistance represents the steady-state temperature rise of the chip junction due to the heat dissipated on the chip surface.

Θ_{JA} : Thermal resistance, junction-to-ambient.

Θ_{JB} : Thermal resistance, junction-to-board.

Θ_{JC} : Thermal resistance, junction-to-case.

Ψ_{JB} : Thermal characterization parameter, junction-to-board.

Ψ_{JT} : Thermal characterization parameter, junction-to-top center.

$$\Theta_{JA} = (T_J - T_A)/P_D$$

$$\Theta_{JB} = (T_J - T_B)/P_D$$

$$\Theta_{JC} = (T_J - T_C)/P_D$$

Where, T_J = Junction temperature.

T_A = Ambient temperature

T_B = Board temperature

T_C = Case temperature which is monitoring on package surface

P_D = Total power dissipation

Θ_{JA} represents the resistance of the heat flows from the heating junction to ambient air. It is an indicator of package heat dissipation capability. Lower Θ_{JA} can be considerate as better overall thermal performance. Θ_{JA} is generally used to estimate junction temperature.

Θ_{JB} is used to measure the heat flow resistance between the chip surface and the PCB board.

Θ_{JC} represents the thermal resistance between the chip surface and the package top case.

Θ_{JC} is mainly used to estimate the heat dissipation of the system (using heat sink or other heat dissipation methods outside the device package).

Table 9-2 Package thermal characteristics⁽¹⁾

Symbol	Condition	Package	Value	Unit
Θ_{JA}	Natural convection, 2S2P PCB	QFN20	53.17	°C/W
Θ_{JB}	Cold plate, 2S2P PCB	QFN20	18.96	°C/W
$\Theta_{JC(top)}$	Cold plate, 2S2P PCB	QFN20	30.61	°C/W
$\Theta_{JC(Bottom)}$	Cold plate, 2S2P PCB	QFN20	7.88	°C/W
Ψ_{JB}	Natural convection, 2S2P PCB	QFN20	19.14	°C/W
Ψ_{JT}	Natural convection, 2S2P PCB	QFN20	2.56	°C/W

(1) Thermal characteristics are based on simulation, and meet JEDEC specification.

10 Ordering information

Table 10-1 Part ordering code for GD30LD3300x devices

Ordering Code	Package	Package Type	Packing Type	MOQ	Temperature Junction Range
GD30LD3300FUTR	QFN20(3.5X3.5)	Green	Tape&Reel	3000	Industrial -40°C to +125°C

11 Revision history

Table 11-1 Revision history

Revision No.	Description	Date
1.0	Initial Release	Nov.26, 2021
1.1	<p>Modify the definition of BIAS pin, it is recommended to use a 1uF capacitor, the modification location is in the Table 4-1. GD30LD3300x QFN20 pin definitions.</p> <p>It is recommended to add specific values of peripheral devices to typical circuits, and the modification location is in Chapter 7.</p> <p>Modify the part ordering code information to GD30LD3300F UTR, the modification location is in the Table 10-1 Part ordering code for GD30LD3300x devices.</p>	Mar.15, 2022
1.2	<p>Increase the parameter information of $\Theta_{JC(Bottom)}$, the modification location is in the Table 9-2. Package thermal characteristics(1).</p> <p>Modify the package outline dimensions and change the chip thickness to (minimum 0.70 typical 0.75 maximum 0.80), the modification location is in the Table 9-1. QFN20 dimensions.</p>	APR.2, 2022
1.3	<p>1.Added Section 4.1 Device information.</p> <p>2.The Ordering Code content in Chapter 10 is modified to GD30LD3300FUTR.</p> <p>3.Chapter 10 Ordering information added information on Packing Type(Tape&Reel) and MOQ(3000).</p>	Jun.08, 2022