

GFL Series - 1 Pole+N, D Trip, 100 mA 10kA UL489 Listed Branch Circuit Breaker with Equipment Ground Fault Protection (RCBO)



The GFL Series range is a combined Branch Circuit Breaker and Equipment Ground Fault Protector, featuring dual pole switching (live and neutral disconnect) and designed to provide protection against short circuits, overloads, AC ground faults (residual current faults) as well as pulsating DC ground faults.



Ordering Information

Rated Current	Type/ Cat. No.	Rated Voltage
5.0A	GFL2D051002	240V AC
6.0A	GFL2D061002	240V AC
8.0A	GFL2D081002	240V AC
10A	GFL2D101002	240V AC
12A	GFL2D121002	240V AC
13A	GFL2D131002	240V AC
15A	GFL2D151002	240V AC
16A	GFL2D161002	240V AC
20A	GFL2D201002	240V AC
25A	GFL2D251002	240V AC

GFL Series RCBO Overload Trip Curves

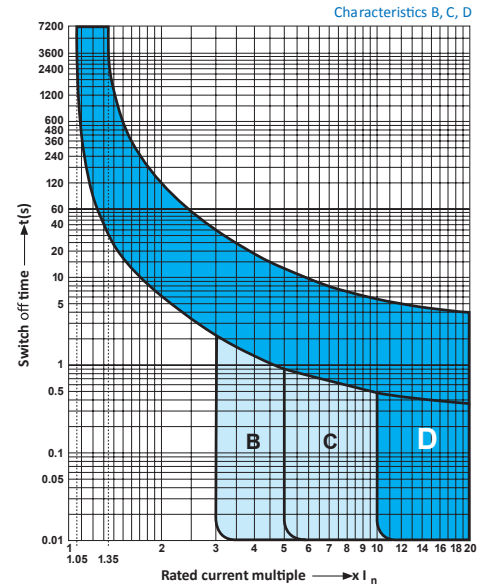

Technical Specification

Number of Poles	1+N
Voltage Rating (maximum)	240V AC
Ground Fault Sensitivity Level	100 mA
Rated Short Circuit Interrupt Capacity	10 kA
Rated Frequency	50/60Hz
Trip Characteristic	D
Cable Size & Tightening Torque	Stranded Wire: 16 - 3 AWG (1.5 mm ² - 25 mm ²) @ 17.5 lb-in (2.0 Nm) Solid Wire: 16 - 10 AWG (1.5 mm ² - 5.5 mm ²) @ 17.5 lb-in (2.0 Nm) 18 - 16 AWG (1 mm ² - 1.5 mm ²) @ 25 lb-in (2.8 Nm)
Electrical Life	6000 Switching Operations
Mechanical Life	10000 Switching Operations

Dimensions
(to convert to inches multiply by 0.03937)

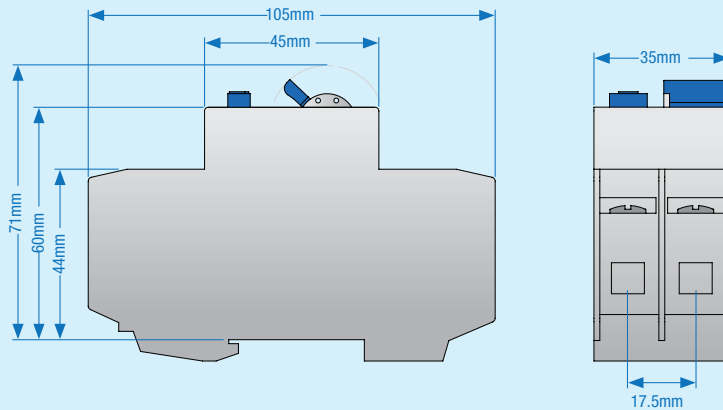

Weight 220 g

GFL Series RCBO Ground Fault Trip Curve

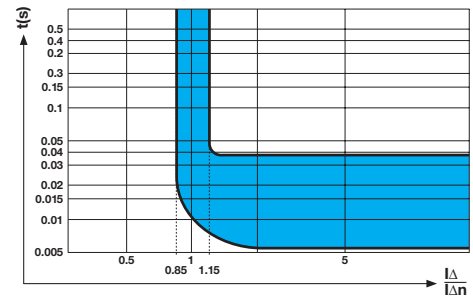

UL 489
Branch Circuit Breaker
with Ground Fault Relay

GFL Series - 1 Pole+N, D Trip, 100 mA
 Applicable voltage systems and wiring examples.



NOTE:
 Wiring a hot leg/phase to
 N terminal is not permitted.

UL 489
 Branch Circuit Breaker
 with Ground Fault Relay