

## GFL Series - 2 Pole, D Trip, 300 mA 10kA UL489 Listed Branch Circuit Breaker with Equipment Ground Fault Protection (RCBO)

The GFL Series range is a combined Branch Circuit Breaker and Equipment Ground Fault Protector, featuring dual pole switching (live disconnect) and designed to provide protection against short circuits, overloads, AC ground faults (residual current faults) as well as pulsating DC ground faults.



### Ordering Information

Rated Current	Type/ Cat. No.	Rated Voltage
5.0A	GFL2D05300S	120/240V AC
6.0A	GFL2D06300S	120/240V AC
8.0A	GFL2D08300S	120/240V AC
10A	GFL2D10300S	120/240V AC
12A	GFL2D12300S	120/240V AC
13A	GFL2D13300S	120/240V AC
15A	GFL2D15300S	120/240V AC
16A	GFL2D16300S	120/240V AC
20A	GFL2D20300S	120/240V AC
25A	GFL2D25300S	120/240V AC
30A	GFL2D30300S	120/240V AC
32A	GFL2D32300S	120/240V AC
35A	GFL2D35300S	120/240V AC
40A	GFL2D40300S	120/240V AC

### GFL Series RCBO Overload Trip Curves

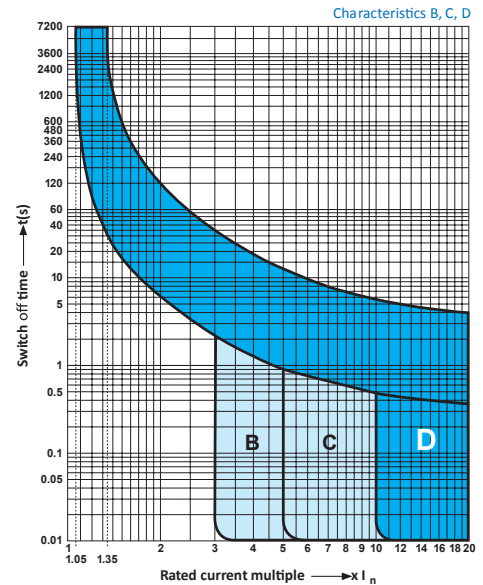

### GFL Series RCBO Ground Fault Trip Curve

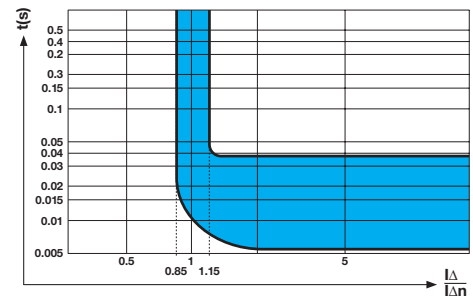

### Technical Specification

Number of Poles	2
Voltage Rating (maximum)	120/240V AC
Ground Fault Sensitivity Level	300 mA
Rated Short Circuit Interrupt Capacity	10 kA
Rated Frequency	50/60Hz
Trip Characteristic	D
Cable Size & Tightening Torque	Stranded Wire: 16 - 3 AWG (1.5 mm <sup>2</sup> - 25 mm <sup>2</sup> ) @ 17.5 lb-in (2.0 Nm) Solid Wire: 16 - 10 AWG (1.5 mm <sup>2</sup> - 5.5 mm <sup>2</sup> ) @ 17.5 lb-in (2.0 Nm) 18 - 16 AWG (1 mm <sup>2</sup> - 1.5 mm <sup>2</sup> ) @ 25 lb-in (2.8 Nm)
Electrical Life	6000 Switching Operations
Mechanical Life	10000 Switching Operations

#### Dimensions

(to convert to inches multiply by 0.03937)

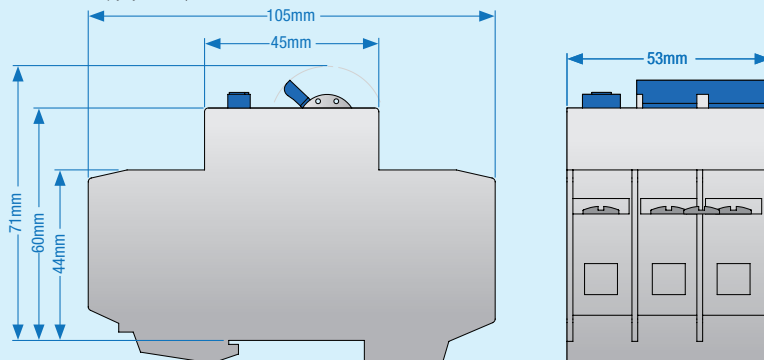

Weight

328 g

Applicable voltage system  
and wiring example.

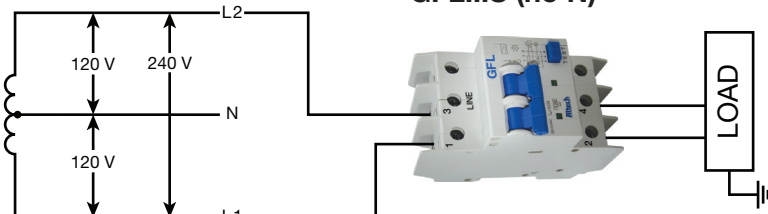

GFL...S (no N)