



eMMC NANDrive™

85VM Series

Product Brief

Product Description

The eMMC NANDrive™ family of embedded solid state drives (SSDs) integrate Greenliant's advanced eMMC controller with one or more NAND flash die in a multi-chip package. eMMC NANDrive is available with 2-bit-per-cell (MLC) or 1-bit-per-cell (SLC) NAND to meet customer requirements for lifespan, endurance and performance. Greenliant's high-reliability SLC NANDrive products use industry leading EnduroSLC™ Technology to address the most demanding embedded applications.

Ideal for automotive, industrial, medical, security and networking applications, eMMC NANDrive is compatible with NXP, NVIDIA, TI, Intel, AMD and other popular chipsets. It operates between -40 and +85 degrees Celsius, giving customers data storage that can withstand extreme conditions. Available in both 100-ball and 153-ball packages and in multiple capacities, these space-saving products are designed with enhanced data integrity and security features.

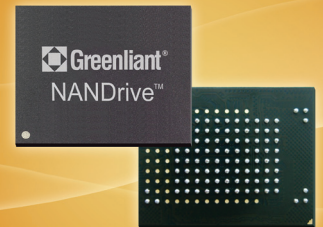

www.NANDrive.com

Key Features

Industry Standard eMMC Interface

- Supports JEDEC eMMC 5.1 (JESD84-B51) and 4.4 standards (JESD84-A44)
- Backward compatible with previous eMMC versions

Wide Range of Products

- Multiple capacities available with 2-bit-per-cell (MLC) or 1-bit-per-cell (SLC) NAND to meet endurance, data retention requirements
- SLC NANDrive SSDs with 50K, 100K, 250K endurance enabled by Greenliant's proprietary EnduroSLC Technology

Power Management

- Supports auto-sleep mode
- Immediately disables unused circuitry without host intervention
- Dedicated pin (PD#) for power fail protection
- Integrated voltage detector

High Performance*

- Sequential Read / Write Performance up to 135 MB/sec / 95 MB/sec[‡]
- Supports HS200 / HS400 modes
- Clock speed up to 200 MHz
- Supports Dual Data Rate (DDR) modes
- High Priority Interrupt (HPI) helps prioritize important host requests

*supported by eMMC 5.1 ‡measured in HS200 mode

Robust Firmware

- Implements advanced global and group wear leveling to maximize product lifespan
- Embedded flash file system (FFS) enables seamless capacity migrations with no change to host software

Built-in ECC

- Uses advanced hardware engine to detect and correct bit errors

Bad Block Management

- Replaces bad blocks with spare blocks in the NAND flash before uncorrectable errors occur

Data Security

- Permanent, temporary and power-on write protection for entire device and specific partition
- Dedicated pin (WP#) for write protection
- Supports RPMB / Sanitize / TRIM for sensitive data protection*

Latency Management

- Reduces latencies due to background operation during time critical read/write operations

Package Options and I-temp Capability

- 100-ball LPGA package with 1mm ball pitch for increased long-term reliability
- 153-ball LFBGA package with .5mm ball pitch
- Industrial operation: -40°C to +85°C

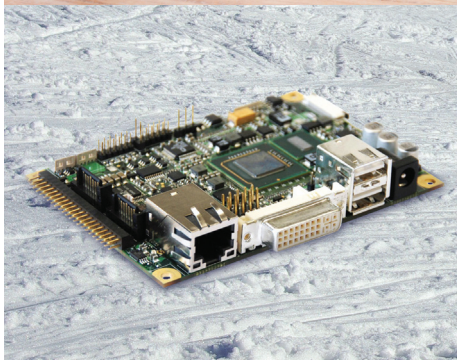

Applications

- In-vehicle infotainment
- GPS and telematics
- Data recorder
- Video conferencing
- Tablet PC
- Multi-function printer
- Point-of-Sale terminal
- VoIP system / PBX
- Wireless base station
- Router / Gateway / Switch
- Set-top box
- Industrial PC / Single-board computer
- Ultrasound and medical imaging
- Industrial automation and control
- Test and measurement equipment
- Video surveillance / ID terminal

Greenliant

3970 Freedom Circle, Suite 100
Santa Clara, CA 95054 USA
Tel. 1-408-200-8000
Fax 1-408-200-8099

www.Greenliant.com

eMMC NANDrive Package Diagrams

153-ball LFBGA package
11.5mm x 13mm x 1.35mm
Pb-free (RoHS compliant)

BOTTOM VIEW

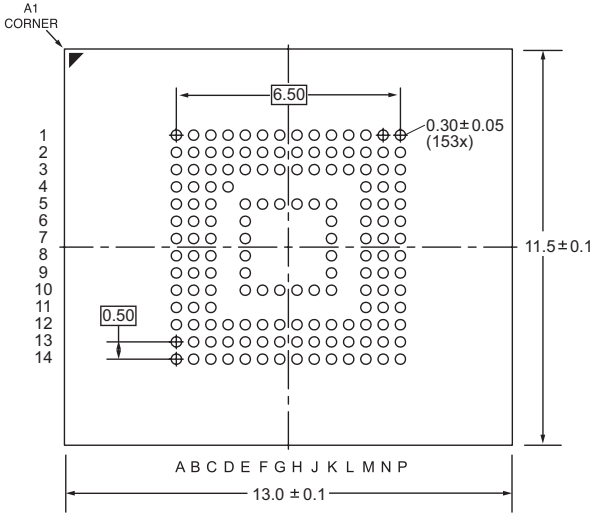

DETAIL VIEW

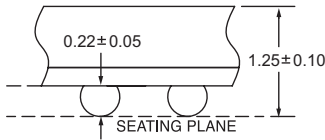

100-ball LPGA package
14mm x 18mm x 1.40mm
Pb-free (RoHS compliant)

BOTTOM VIEW

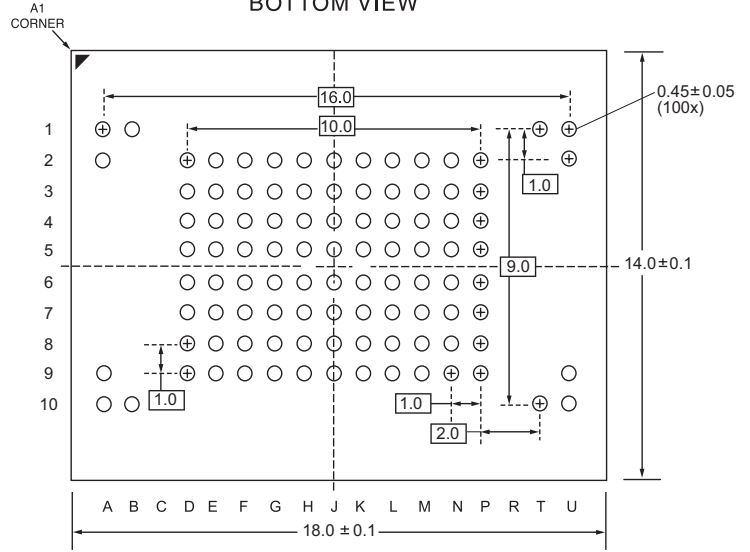

DETAIL VIEW

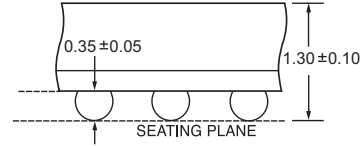

eMMC NANDrive Block Diagram

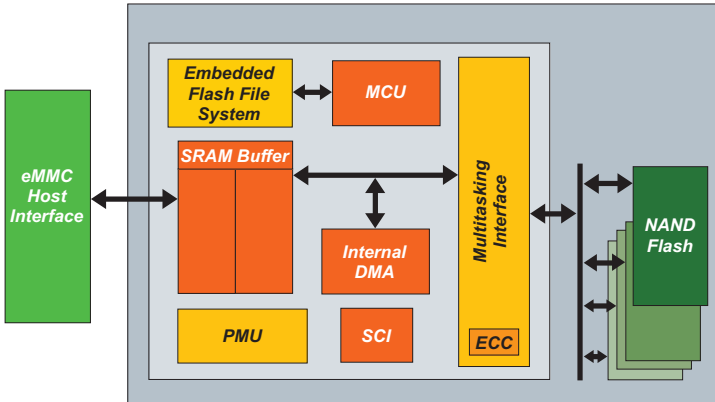

eMMC Product Lineup

| 85VM Series eMMC NANDrive | | | |
|---------------------------|--|---|---------------------------------|
| eMMC Standard | Product Series / Capacity | NAND Configuration / Endurance | Package Type |
| 4.4 | 8 GB – 64 GB | 2-bit-per-cell MLC NAND / 5K P/E cycles | 100-ball LPGA |
| 5.1 | EX 2 GB – 4 GB 2 GB – 32 GB | 1-bit-per-cell SLC NAND / 50K, 100K, 250K P/E cycles* | 100-ball LPGA 153-ball LFBGA |
| | MX 8 GB 8 GB – 64 GB | 2-bit-per-cell MLC NAND / 5K P/E cycles | 100-ball LPGA 153-ball LFBGA |

*Designed with Greenliant's advanced EnduroSLC Technology 250K, or higher, endurance offered up to 16GB

EnduroSLC™

- twitter.com/Greenliant
- linkedin.com/company/Greenliant
- facebook.com/Greenliant

NANDrive FAQs: www.greenliant.com/nandrive-faqs

Evaluation Boards: www.greenliant.com/nandrive-eval-boards

Long-Term Availability: www.greenliant.com/support/#LTA-program

For more information, contact your Greenliant representative: www.greenliant.com/sales



© 2021 Greenliant
Greenliant, the Greenliant logo, EnduroSLC and NANDrive are trademarks of Greenliant.
These specifications are subject to change without notice. 01/2021