



This product, formerly sold by ams AG, and before that optionally by either Applied Sensors GmbH, acam-messelectronic GmbH or Cambridge CMOS Sensors, is now owned and sold by

SciSense

The technical content of this document under ams / Applied Sensors / acam-messelectronic / Cambridge CMOS Sensors is still valid.

Contact information

Headquarters:

SciSense B.V.

High Tech Campus 10

5656 AE Eindhoven

The Netherlands

info@sciosense.com

www.sciosense.com



Ultrasonic-Flow-Converter

Data Sheet

GP22-EVA-KIT

Evaluation System for TDC-GP22
Time-to-Digital Converter

15th July 2013

Document-No: DB_GP22-EVA_en VO.2

Published by acam-messelectronic gmbh

©acam-messelectronic gmbh 2013

Disclaimer / Notes

The GP22-EVA-KIT is an evaluation system for the integrated circuit TDC-GP22, offered by acam-messelectronic. It is intended for use for engineering development, demonstration or evaluation.

The information provided by this preliminary datasheet is believed to be close to the final product.

However, it is theoretical and no responsibility is assumed by acam for its use, nor for any infringements of patents or other rights of third parties that may result from its use. The information is subject to change without notice and is provided „as is“ without warranty of any kind (expressed or implied). Brand and product names in this document are trademarks or service marks of their respective owners.

Support / Contact

For a complete listing of Direct Sales, Distributor and Sales Representative contacts, visit the acam web site at:

<http://www.acam.de/sales/distributors/>

For technical support you can contact the acam support team in the headquarters in Germany or the Distributor in your country. The contact details of acam in Germany are:

support@acam.de

or by phone

+49-7244-74190.

Content

1	Introduction	1-1
1.1	General	1-1
1.2	System Overview	1-1
1.3	System Components	1-1
2	Hardware Description	2-1
2.1	Introduction	2-1
2.2	Clock sources	2-1
2.3	Power Supply and Current Consumption	2-2
2.4	Communication Interface	2-3
2.5	TDC - Interfaces	2-4
2.6	Temperature Measurement.....	2-7
3	Software Description	3-1
3.1	Installation	3-1
3.2	Setup & General Settings Tab	3-6
3.3	Measurement Settings	3-12
3.4	Standard TDC Measurement	3-17
3.5	Ultrasonic Time-of-Flight Measurement.....	3-19
3.6	Temperature Measurement.....	3-24
3.7	Graphic	3-27
4	Layout and Schematics	4-1
4.1	Evaluation Board BOM	4-1
4.2	Layout/Schematics	4-3
5	Miscellaneous	5-1
5.1	Literature Guide	5-1
5.2	Last Changes	5-1

1 Introduction

1.1 General

The GP22-EVA-KIT evaluation system is designed as a platform for a quick and easy start-up and evaluation of the TDC-GP22 Time-to-Digital Converter. The EVA-Kit offers user-friendly configuration and extensive testing of the TDC-GP22.

For a proper use of the evaluation system, we strongly recommended to refer to the current TDC-GP22 datasheet. You can download this datasheet from www.acam.de/download-center/time-to-digital-converters.

1.2 System Overview

The GP22-EVA-KIT is a full featured evaluation system for the TDC-GP22 Time to digital converter. It serves as

- System for evaluating ultrasonic time-of-flight measurement applications
- Evaluation Kit for TDC-GP22 time interval measurements

Features

- PC supported system with USB communication interface
- Easy to use evaluation and measurement software
- Different power options, selectable by jumpers
- Three reference clock sources for alternate clock options
- Pt1000 Temperature measurement with on board reference, hardware option for Pt500 sensors (sensors n.c.)
- Internal / external comparator for temperature measurement
- Easy connection of external microcontroller boards
- Data collection to ASCII text files
- Built-in display of measurement results

1.3 System Components

The GP22-EVA-KIT includes the following components:

- GP22-EVAL: Evaluation board for TDC-GP22 Time-to-Digital Converter
- PICOPROG V2.0: USB-to-SPI communication interface

- High density DSUB15 cable: For connecting the evaluation system to the PICOProg V2.0 communication interface
- USB cable: For connecting the PICOProg communication Interface to the local PC
- CD-ROM: Contains software, drivers, examples and technical documentation

PC connection

The GP22-EVAL board is connected to the PC via PicoProg 2.0 device. The PicoProg 2.0 acts as USB to SPI communication interface and provides the power supply of the board. Figure 1.1 on the following page gives an overview. The 15 pin DSUB high density cable connects the GP22-EVAL hardware to the PicoProg 2.0. Additionally, a USB cable is delivered to connect the PicoProg 2.0 with a free USB port of the local PC.

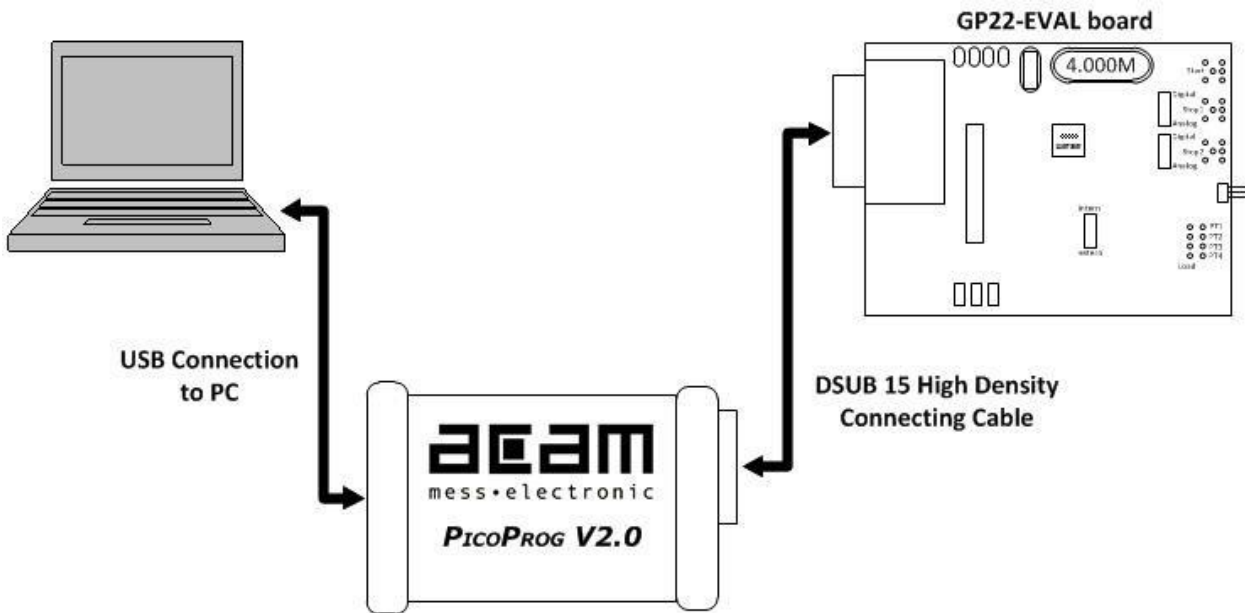

Figure1.1 System Block diagram

2 Hardware Description

2.1 Introduction

The GP22-EVA-KIT, shown in figure 2.1, is an evaluation system for the TDC-GP22 Time-to-Digital Converter. It offers full access to the TDC-GP22 in order to test and evaluate this device for your application.

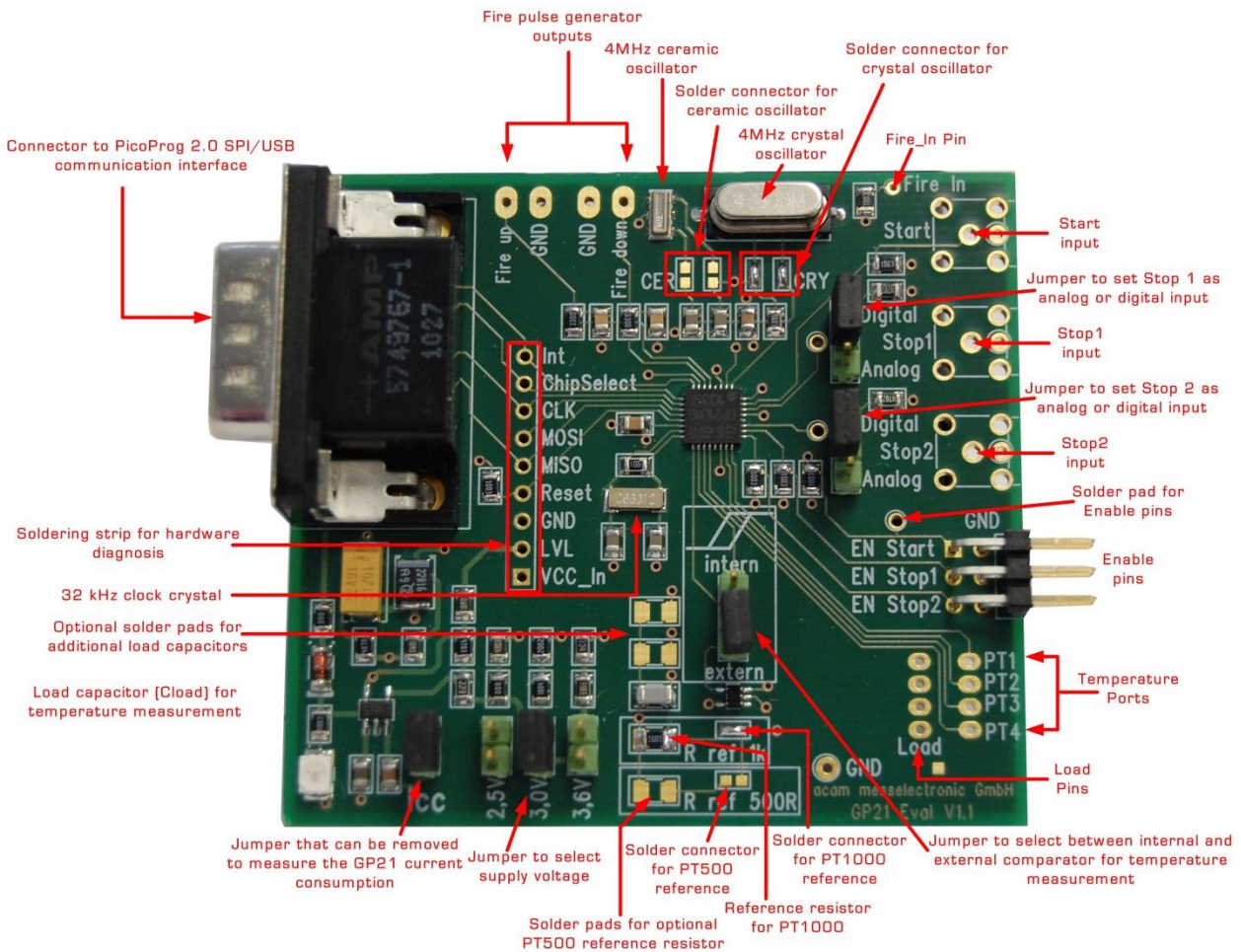

Figure 2.1 GP22-EVA-KIT Hardware

2.2 Clock sources

Besides the 32,768 Hz quartz, the GP22-EVA-KIT includes two high speed clock sources, a 4 MHz crystal and a 4 MHz ceramic oscillator. The high speed clock source can be selected by closing the appropriate jumper connectors (LJ1 to LJ4). By default LJ3 and LJ4 are closed so the 4 MHz crystal operates as the system’s high speed clock source.

Solder connector LJ1, LJ2 closed → Ceramic oscillator (CER) selected

Solder connector LJ3, LJ4 closed → Crystal Oscillator (CRY) selected (Default)

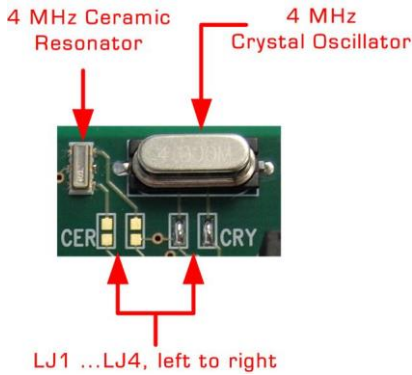

Figure 2.2 High speed clock sources and solder connectors

2.3 Power Supply and Current Consumption

The GP22-EVA-KIT hardware is powered via USB by the PicoProg 2.0 communication interface. The supply voltage is provided through the 15-pin VGA connector (J1) and can be adjusted by setting the appropriate jumper. Closing J2, J3 or J4 selects the corresponding supply voltage. In figure 2.4 the supply voltage is adjusted to 3.0 V.



Figure 2.3: 15-pin VGA connector for power supply

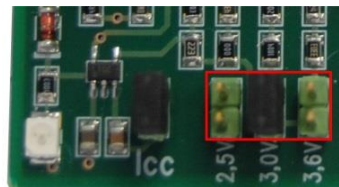

Figure 2.4 Jumpers to select the supply voltage

J2 closed: 2.5 V

J3 closed: 3.0 V (Default)

J4 closed: 3.6 V

In some cases it might be useful to operate the GP22-EVA-KIT without the PicoProg2.0 device, e. g. if the hardware is connected to a microcontroller developers kit. Then the supply voltage can be fed to Vcc and GND pins of the J19 solder strip. Even in this case

the supply voltage can be adjusted by setting the jumper J2, J3 or J4, as described above.



Figure 2.5 External power supply via J19

Current Consumption

Portable or battery driven systems like e. g. heat meters demand for energy efficient design. To measure the current consumption of the system, Jumper J5 can be left open and connected to an ampere meter.

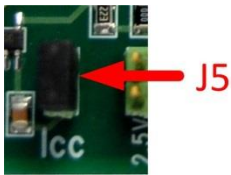

Figure 2.6: Measure power consumption

2.4 Communication Interface

2.4.1 VGA Connector



In combination with the PICOPROG 2.0 device the 15-pin VGA-connector shown below is also used for SPI data communication. The PICOPROG 2.0 then provides the USB to SPI conversion for data transfer with the PC based measurement and configuration software.

Figure 2.7: 15-pin VGA connector for power supply and data communication via PICOPROG 2.0

2.4.2 Interfacing an external Microcontroller

Alternative to the VGA connector soldering strip J 19 offers easy access to the SPI data communication and to signals that are useful for system diagnosis. This is useful when external hardware like a microcontroller development board should be connected to the GP22-EVAL board.

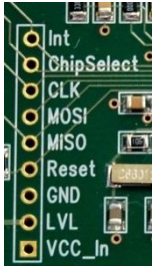

Figure 2.8: SPI interface for external hardware

Table 2.1 Signal Description

Terminal	Description
Int	GP22 Interrupt pin
ChipSelect	SPI Chipselect line (SSN – Slave Select)
CLK	SPI Clock (Clock Serial Interface)
MOSI	SPI serial data in (Master Out Slave In)
MISO	SPI serial data out (Master In Slave Out)
Reset	GP22 Reset line (low active)
GND	Ground Connection
LVL	Supply voltage for PicoProg 2.0 internal level shifters
Vcc In	Optional Power supply, can be used if the system shall be powered without using the PicoProg 2.0 communication interface

2.5 TDC - Interfaces

2.5.1 Fire Pulse Generator Outputs

The fire pulse generator’s outputs (J11 to J14) offer direct connection of the piezo ceramic transducers for up and down measurement, as it is typical in time-of-flight applications, like ultrasonic flow- or heat meters.

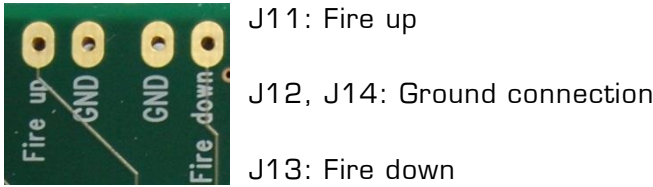

Figure 2.9: Fire pulse generator outputs

2.5.2 Fire In

Fire in (J18) is an input that offers the possibility to extend your signals transit time by means of the “sing around method”. Using that option, the received echo pulse can directly fed to this input for multiple resend. Additionally, Fire In can act as an output. Here, it offers enhanced functionality for hardware diagnosis, configurable by software via SEL_TSTO1 settings (see also table 3.14 in section 3.2.3.7).



Figure 2.10: Fire in

2.5.3 Start Input

The Start channel (J6) is an LVTTTL input that acts as TDC-GP22 start. It triggers the beginning of a time interval measurement. The mounting holes of the start channel offer the possibility to solder an SMB series RF connector (e. g. Bürklin Type JO1160AO231) or a straight dual pin connector, to easily interface with peripheral hardware. Optionally, direct soldering is also possible.

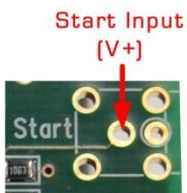

Figure 2.11 Start input channel

Note: If SEL_START_FIRE item is activated by software, the fire out signal of the pulse generator triggers the TDC start. In that case the start input channel is disabled.

2.5.4 Stop Channels

Stop 1 (J7) and Stop 2 (J8) are the Stop inputs for TDC-GP22. They can be interfaced to analog or digital sources. The selection is done by configuration of the 3-pin jumpers J9 and J10. J9 switches STOP1 as analog or digital input, J10 refers to STOP2. Similar to the start channel, the mounting holes of the stop channels offer the possibility to solder an SMB series RF connector (e. g. Bürklin Type JO1160AO231) or a straight dual pin connector, to easily interface with peripheral hardware. Direct soldering is also possible.

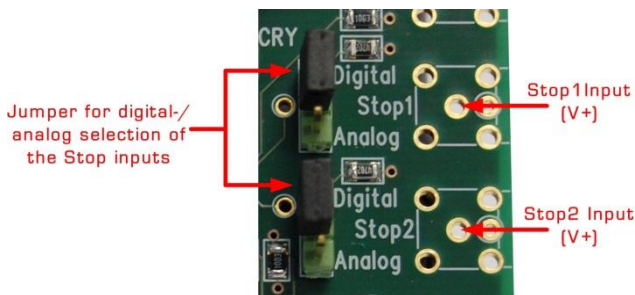
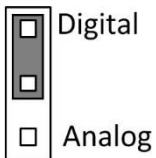

Figure 2.12: Stop channels and the corresponding jumpers to switch over between analog-and digital input mode.

Digital LVTTTL input enable



Analog input enable

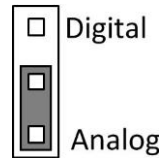

Figure 2.13: Jumper settings for analog/digital enable

2.5.5 Start / Stop Enable Pins

J12 provides the high active enable pins for the TDC-GP22 start and stop channels. Each of the three LVTTTL inputs can be used for externally enabling / disabling the corresponding input channel, e. g. by connecting them to your microcontroller's general purpose I/O pins.

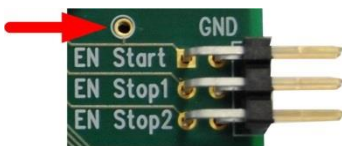

Figure 2.13: Enable pins for Start- / Stop channels

EN_Start: By default, high level on EN_Start enables the GP22 start input. Additionally, it can act as an output. The EN_Start pin then offers enhanced functionality for hardware diagnosis, configurable by setting SEL_TSTO2 (see also table 3.13 in section 3.2.3.7). Easy access to the EN_Start diagnosis signals is provided by an additional soldering pad, as shown in figure 2.13.

EN_Stop1: High level on this pin enables stop 1 input

EN_Stop2: High level on this pin enables stop 2 input

2.6 Temperature Measurement

In some applications, like ultrasonic heat meters, temperature difference measurement is an important feature. Here, the GP22-EVA-KIT offers a fully equipped PICO STRAIN based temperature measurement interface for PT500 and PT1000 temperature sensors.

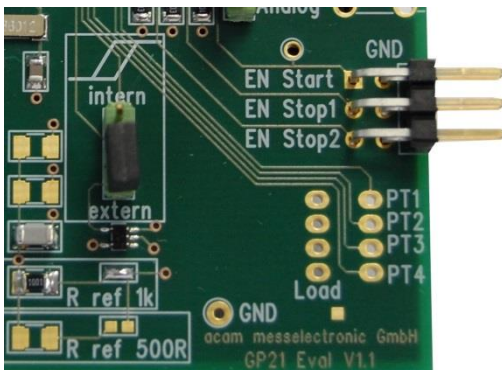

Figure 2.14: Hardware section for temperature measurement

2.6.1 Connecting the temperature sensor

The system offers 4 temperature ports with the possibility of connecting up to 4 temperature sensors. Each of the up to 4 sensors has to be connected between the Load line and the PT1 to PT4 temperature ports. The load pads are wired in parallel.

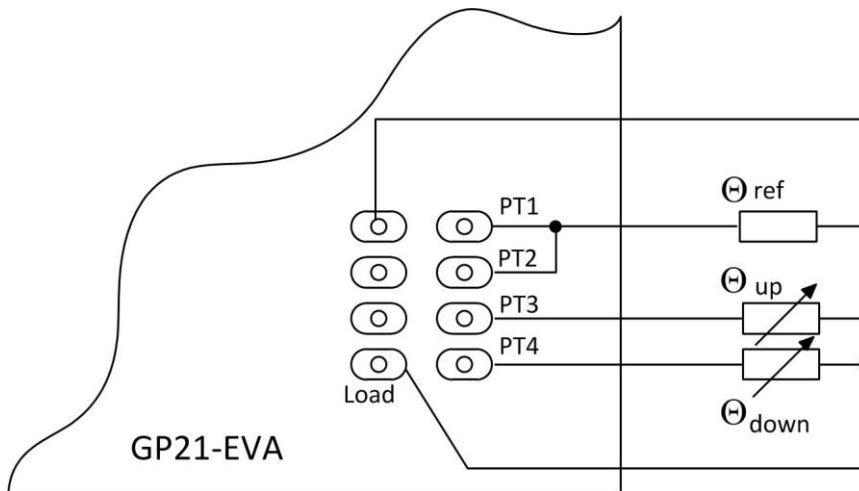

Figure 2.15: Temperature difference measurement with one external reference resistor

PT1+PT2: External reference resistor

PT3: Temperature sensor for higher temperature (hot)

PT4: Temperature sensor for lower temperature (cold)

As a further option, the system allows temperature difference measurement against an on-board metal film resistor as a reference. By default, a temperature stable 1k metal film resistor (R29, 50 ppm) is assembled and solder connector LJ5 is closed. This prepares the system for Pt1000 sensors. Optionally, a 500 Ohm resistor can be soldered on the board, as Pt500 reference. The selection of the correct reference is simply done by closing the corresponding solder connector. The following picture shows the details.

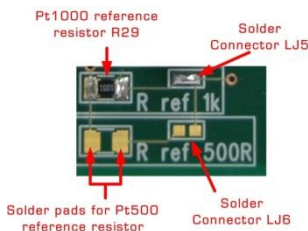

Figure 2.16: On-board reference resistor

If the On-board reference is used, the temperature sensors have to be connected in the following manner:

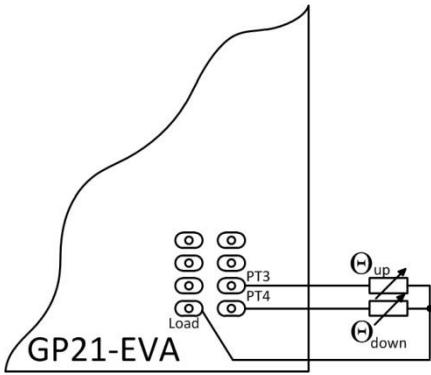

Figure 2.17 Connecting the temperature sensors using the on board reference resistor

- PT1+PT2: On board Reference resistor, connected by closing the corresponding soldering connector LJ6, LJ7 (see figure 2.14)
- PT3: Temperature sensor for higher temperature (hot)
- PT4: Temperature sensor for lower temperature (cold)

2.6.2 Load Capacitor Selection and Assembly

Depending on your temperature sensor’s base resistance a load capacitor has to be selected and assembled on the system. As the discharge time should be in the range of 150 μ s the following capacitor values are recommended:

- Pt500: 220 nF
- Pt1000: 100 nF (Default)

To get best results, we recommend COG type or CFCap series from Tayo Yuden. Up to three capacitors can be soldered in parallel. By default the system comes with a 100 nF COG type, suited for Pt1000 measurements

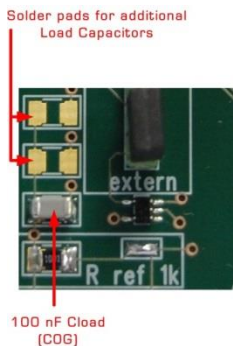

Figure 2.18: Load capacitor C17 and additional solder pads

2.6.3 Selecting the Comparator

For temperature measurement the external 74AHC14 Schmitt Trigger or the GP22 internal low noise comparator can be used. The selection is done by setting jumper, as shown in the picture below. Here the external Schmitt Trigger is selected:



Figure 2.19: Jumper to select between internal comparator or external Schmitt Trigger

intern: Selects the GP22 internal comparator

extern: Uses external 74AHC14 Schmitt Trigger (Default)

Note: For a proper work the correct setting of „NEG_STOP_TEMP“ parameter in the “Temperature Measurement” sheet of the software is mandatory. For details, please refer to table 3.24 in chapter 3.2.6.3 „Temperature port settings“

3 Software Description

The GP22-EVA-KIT evaluation system comes with a comfortable Windows based configuration and measurement software. This chapter describes the installation and explains how to access all the functionality of the GP22-EVA-KIT. The following steps are required:

1. Install the PicoProg 2.0 driver
2. Install the GP22-EVA-KIT software
3. Restart the PC
4. Connect evaluation system to the PC und run the GP22-EVA-KIT software

Important Note:

Install the PicoProg 2.0 driver and the GP22-EVA-KIT software before connecting the system to the USB port of the PC. This ensures that the system is correctly recognized when it is connected to the PC. The PicoProg 2.0 driver and the GP22-EVA-KIT software is compatible to Windows XP (SP3) and Windows 7 (32 and 64-Bit version)

3.1 Installation

3.1.1 PicoProg 2.0 Driver Installation

Insert the GP22-EVA-KIT CD, select the folder Driver\PicoProg v2 Driver Installer Stand-Alone and run the installer by double clicking setup.exe.

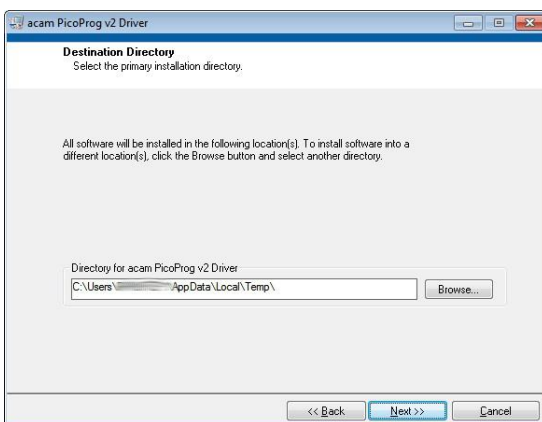

Figure 3.1: Run the Driver Installer

Accept the proposed path by clicking on “Next” button and confirm the license agreement.

The following Screen appears:

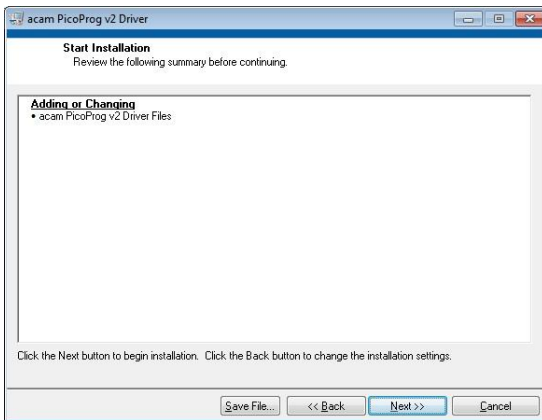

Figure 3.2 Run the PicoProg 2.0 installer

Now run the installer by again clicking on “Next”.

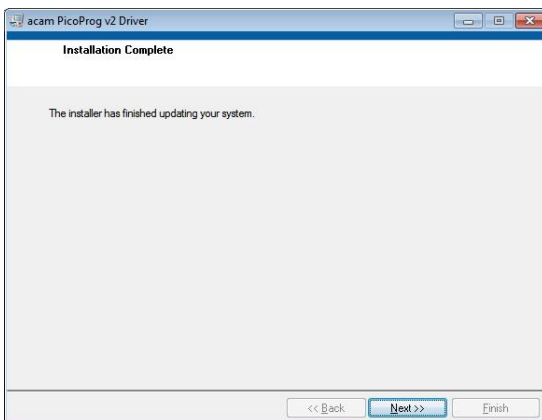

Figure 3.3: Installation complete

Confirm with “Next”. Then a command shell window comes up and asks you to unplug the PicoProg.

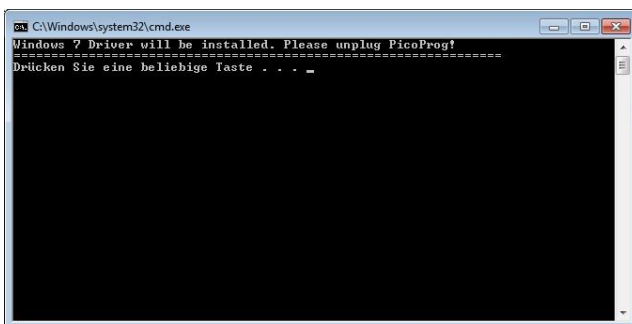

Figure 3.4: Command shell comes up

Check that there is no PicoProg device connected to the PC. Then press a key to proceed. Override the “unsigned driver” warning.

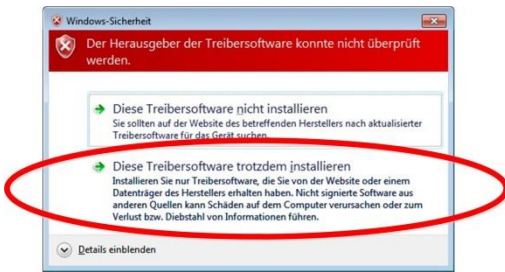

Figure 3.5 Confirmation before driver installation

Please install the driver anyway. Then the command shell asks you to plug in the PicoProg V2.0

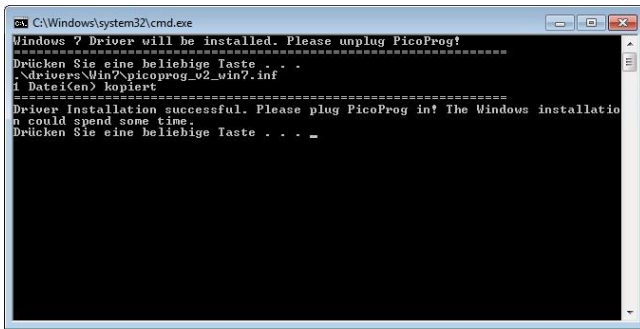

Figure 3.6 Plug in PicoProg V2.0

Plug in the PicoProg device and press a key.

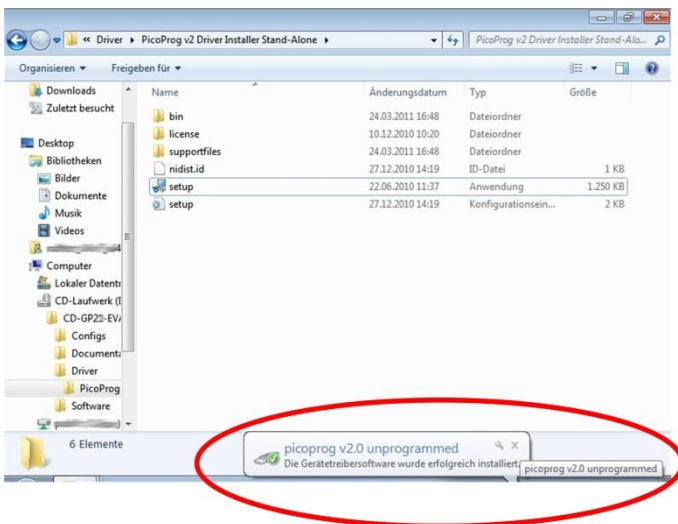

Figure 3.7 Driver installed

Now the PicoProg v2.0 driver has successfully been installed. To verify the installation you can open the device manager and locate the driver as shown in figure 3.8.

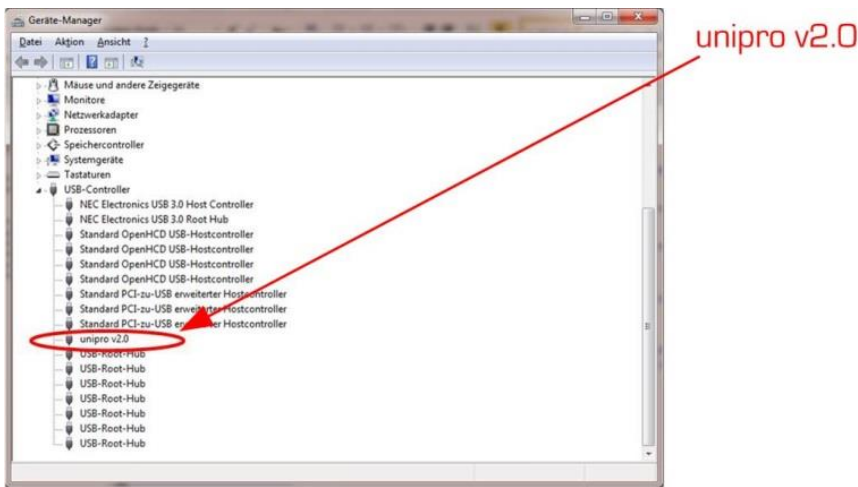

Figure 3.8 PicoProg 2.0 driver verification

3.1.2 Software Installation

The GP22-EVA-Kit comes with a self-installing measurement and configuration software. It is provided on the CD and can be installed after the PicoProg installation has been finished successfully. The following screenshots explain the software installation procedure.

Insert the CD, go to folder Software\GP22_v19 (version 1.9 or newer) Installer and run the installer by clicking "setup.exe"

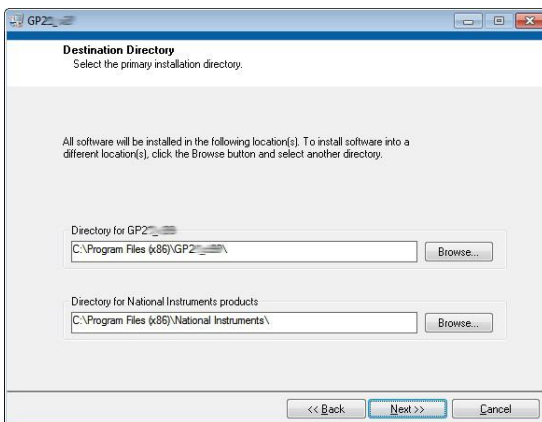

Figure 3.9 Run the installer

Now select the installation path. Recommended is the default setting. Then click to "Next" and confirm the license agreement. After that, a window appears that shows a summary of the software to be installed.

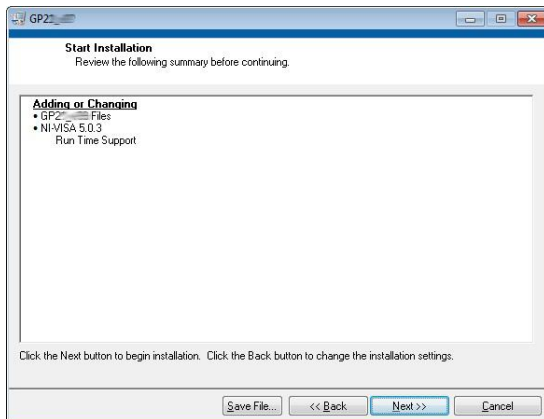

Figure 3.10: Summary of installation

Go on with “Next”. Then the software installation will be completed.

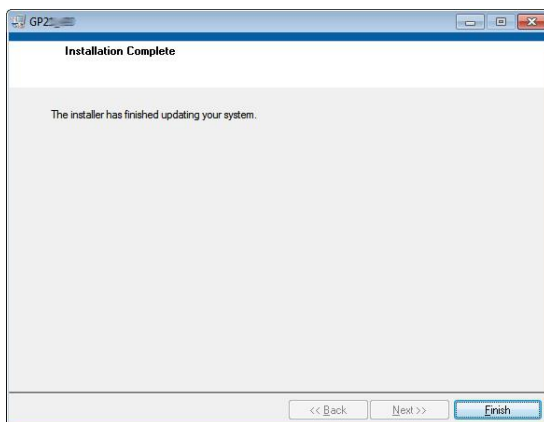

Figure 3.11: Installation complete

Finally, confirm with “Finish”. Now the system asks for a restart of the PC.



Figure 3.12: Restart your System

Click to “Restart”.

3.2 Setup & General Settings Tab

After starting the software by selecting GP22_v19 (version 1.9 or newer) from the Windows start menu the following screen appears.

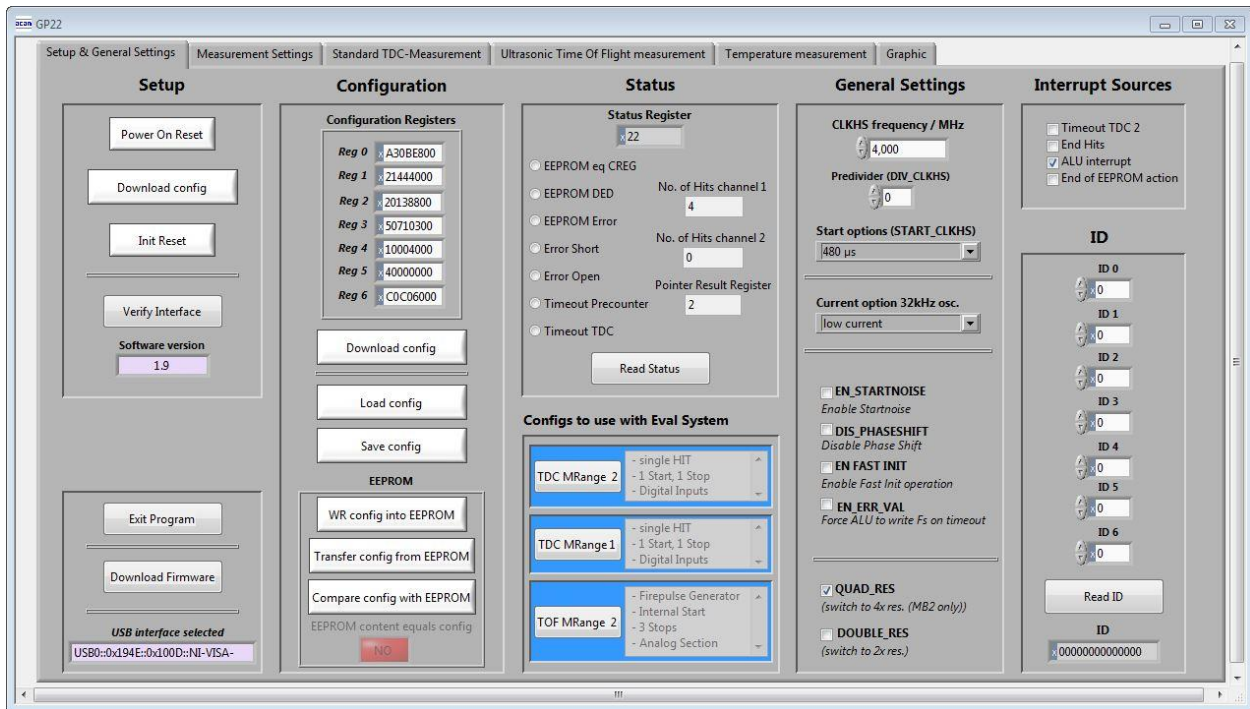

Figure 3.13: Setup & General Settings

The “Setup & General Settings” sheet is divided in different main sections that are explained in the following chapters.

3.2.1 Setup

The setup section provides basic communication functionality between the GP22-EVA-KIT software and the GP22-EVA Hardware. This functionality is mainly used to download the current configuration settings and to prepare the GP22-EVA hardware before starting a measurement.

In general, the following steps have to be executed before a measurement can be started:

Power on Reset → Download Configuration → Init Reset

Then the system is configured and ready to start measuring.

Table 3.1 Software functionality in the Setup section

Terminal	Description
Power On Reset	Executes a Power on Reset of the TDC-GP22 hardware by sending SPI opcode 0x50. This resets the complete hardware including the GP22 configuration registers.
Download config	Transmits the current software configuration to the TDC-GP22 configuration registers
Init Reset	Prepares the TDC-GP22 for a measurement by sending the init instruction (0x70). Compared to the „Power on reset“ command the init instruction does not reset the content of the configuration register.
Verify Interface	Offers the possibility to check the USB to SPI communication between your local PC and the GP22-EVA Kit hardware.
Software Version	Displays the version of the currently installed GP22-EVA software
Exit Program	Exits the GP22-EVA software
Download Firmware	Offers the possibility to manually download the firmware of the PicoProg V2.0 USP to SPI communication interface. Before using this option please contact acam technical support
USB interface selected	Displays the Product ID and Vendor ID of the USB interface that is selected by the NI-VISA driver. Vendor ID: 0x194 GP22-EVA-KIT Product ID: 0x100D

3.2.2 Configuration

This section displays the GP22 register configuration and offers the possibility to

save the configurations settings in a *.cfg-file

load a stored configuration from a *.cfg-file

download the current configuration to the GP22-EVA-KIT.

Additionally, the EEPROM section provides the basic instruction set for GP22 EEPROM access.

Table 3.2 Configuration section

Terminal	Description
Configuration Register	Displays the current configuration setting
Download config	Click on this button transmits the current software configuration into the GP22-EVA-KIT hardware
Load config	Opens a file open dialog to load an existing configuration file (*.cfg) to the software
Save Config	Opens dialog to store the current configuration in a *.cfg file on your PC
WR config into EEPROM	Writes the current configuration settings to GP22 EEPROM
Transfer config from EEPROM	Transfers the configuration from GP22 EEPROM to the GP22 configuration registers
Compare config with EEPROM	Compares the current configuration settings with the register configuration that is stored in the GP22 EEPROM and indicates "YES" or "NO" in case of success or not

3.2.3 Status

Status shows the content of the GP22 status register. To read or update the current GP22 status, just click on the "Read Status" Button.

Table 3.3 Status

Terminal	Description
Status Register	Displays the content of the GP22 status register (by default as hex values)
EEPROM eq. CREG	If this item is activated it indicates that the content of the configuration registers equals to the EEPROM
EEPROM_DED	Indicates a multiple EEPROM error that cannot be corrected
EEPROM_Error	A single error has been detected and corrected
Error Short	Indicates a shorted sensor on GP22 temperature measurement port
Error open	Indicates an open sensor on GP22 temperature measurement port
Timeout Precounter	Indicates an overflow of the 14 bit precounter of the GP22 in Measure Mode 2

Timeout TDC	Indicates an overflow of the TDC unit
Read Status	Forces the software to read the content of the TDC-GP22 status register and displays the current status as explained above.

3.2.4 Configs to use with Eval System

The GP22EVA-KIT software contains three preconfigured ready-to-use examples. They can be selected by clicking the requested button in the “Configs to use with Eval System” section. Then the software automatically loads the corresponding configuration settings. Sequentially pressing the buttons “Power On Reset → Download config → Init Reset” transmits the current setting to the GP22-EVA hardware and the system is ready to start measuring.

Table 3.4 Preconfigured ready-to-use examples

Configuration	Description
TDC MRange 2	Basic TDC-GP22 configuration example for a single hit application of the device in measure mode 2. It executes a delay time measurement in the range between 500ns to 4 ms, triggered by a start event on start input and a stop event on digital stop 1 input.
TDC MRange 1	Basic TDC-GP22 configuration example for a single hit application of the device in measure mode 1. It executes a delay time measurement in the range between 3.5 ns to 2.5 μs, triggered by a start event on start input and a stop event on digital stop 1 input.
TOF MRange 2	Here, a typical time-of-flight example configuration is provided. The TDC-GP22 operates in measure mode 2 with quad resolution mode, uses its integrated analog section and the fire pulse generator. At the beginning of a measurement sequence, the pulse generator sends a 1 MHz burst of 10 pulses on Fire out. On the receiver side, this configuration uses the integrated first-hit detection with 20 mV initial offset. The 3rd, 4th and 7th hit after the first hit are measured. Also, the pulse width measurement is active. DELVAL1 is set to 5000 (39 μs) to suppress noise from the fire pulses.

3.2.5 General Settings

The “General Settings” section contains basic configuration parameters that are application specific. All information for a correct configuration is explained here.

Table 3.5 General Settings

Terminal	Description
CLKHS frequency / MHz	Indicates the frequency of the GP22 high speed oscillator. By default, this value is set to 4 MHz according to the pre-assembled 4 MHz oscillator on the GP22-EVA-KIT hardware. Replacing this oscillator by another one having a different frequency (2 to 8 MHz) requires the adaption of this value, as it is used to calculate the measurement results that are displayed in GP22-EVA-KIT software.
Predivider (DIV_CLKHS)	Sets the High Speed Clock Divider. 0 = divided by 1 1 = divided by 2 2 = divided by 4
Start options (START_CLKHS)	Defines the start options of the high speed clock source, especially the settling. Settling means, letting the oscillator stabilize after switch-on. Osc. Off = Oscillator is switched off Osc. Continuously On; 1 = Oscillator continuously on 480 μ s = settling time 480 μ s 1.46 ms = settling time 1.46 ms 2.44 ms = settling time 2.44 ms 5.14 ms = settling time 5.14 ms
Current option 32 kHz osc.	Option for the 32 kHz crystal oscillator. Reduces consumption. Low current = enables current saving option (recommended setting) High current = disables current saving option, but guarantees oscillation
EN_STARTNOISE	Enables additional noise in start channel, to improve statistics (when averaging)
DIS_PHASESHIFT	Disables the phase-noise generator. Phase noise should be enabled, though, in those applications where the start pulse is derived from the GP22 high speed clock (e. g. when fire pulse generator is used for start pulse generation)
EN_FASTINIT	Enables fast init operation. Here, the GP22 is automatically prepared for the next measurement by internally executing the init instruction after an interrupt.
EN_ERR_VAL	Activating this item forces the ALU to write 0xFFFFFFFF into the result register when a timeout occurs
QUAD_RES	Increases the resolution by factor 4 to typ. 22 ps (Quad Resolution Mode, only available in Measure Mode 2)
DOUBLE_RES	Increases the resolution by factor 2 to typ. 45 ps (Double Resolution Mode, available in Measure Mode 1 & 2)

3.2.6 Interrupt Sources

The TDC-GP22 offers several interrupt sources that can be enabled by activating the corresponding item.

Table 3.6 Interrupt Sources

Terminal	Description
Timeout TDC 2	An interrupt occurs with TDC overflow ("timeout").
End Hits	An interrupt occurs when the expected number of hits has been received
ALU Interrupt	An interrupt occurs if the ALU has finished calculation (has to be enabled for multi hit applications)
End of EEPROM action	An interrupt occurs when EEPROM data transfer is completed.

3.2.7 ID

The TDC-GP22 has a 7x32 bit EEPROM that can be used to store the configuration data together with a device ID or version number. Here, the device ID can be created with arrow up/down buttons or with direct input to the corresponding text field. Read access to a stored device ID is provided by click on the "Read ID" button.

Table 3.7 Customer specific ID number

Terminal	Description
IDO...ID6	Text fields for input of the requested ID number
Read ID	Mouse click on this button reads the current ID from the GP22 EEPROM
ID	Displays the ID that has been read from the EEPROM after mouse click on "Read ID"

3.3 Measurement Settings

The “Measurement Settings” tab allows access to configure the GP22 time interval measurement according to the requirements of your application. It is shown in figure 6.2.

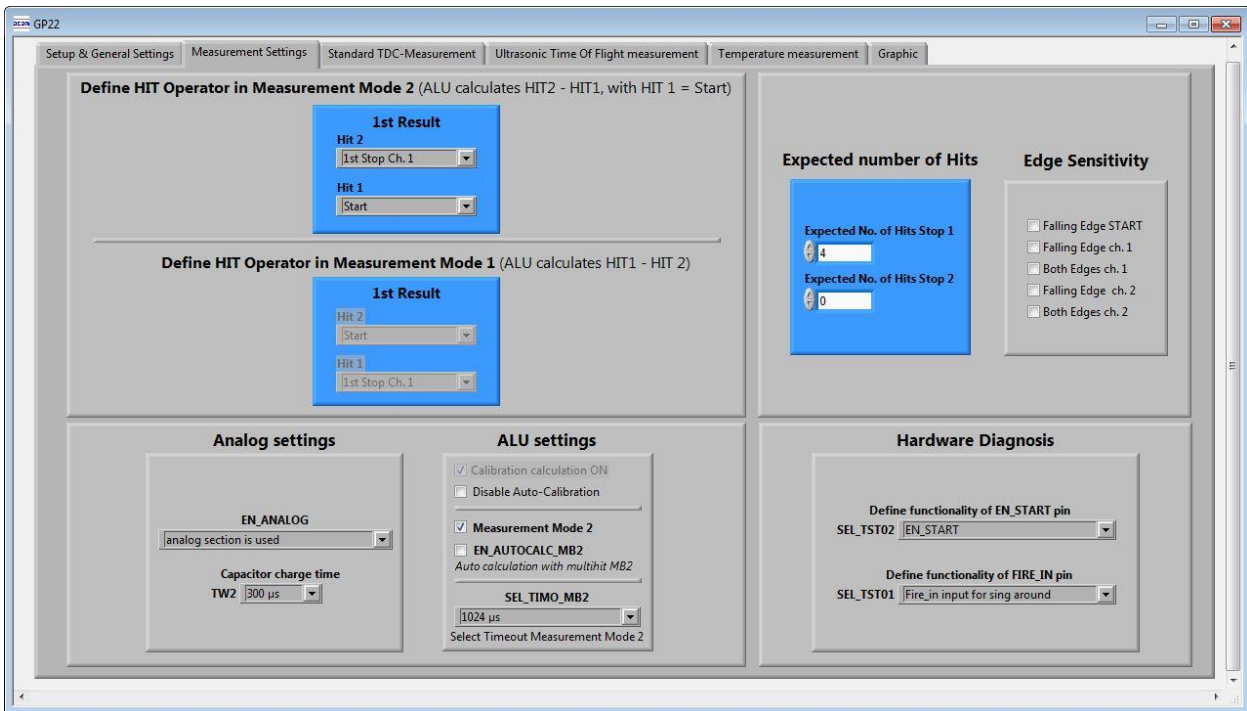

Figure 3.14: Measurement Settings

3.3.1 Define HIT Operator in Measure Mode 2

The TDC-GP22 integrates an arithmetic logic unit to calculate the measurement results. The basic ALU calculation rule is specified by the HIT1 and HIT2 operators. In Measure Mode 2 it is always $HIT2 - HIT1$, whereas HIT1 is dedicated to the start event. Because of that, the incoming stop events have to be assigned to HIT2 operator. In Measure mode 2 the GP22 is capable of measuring up to three hits on the stop input.

Table 3.8: Definition of HIT1 and HIT2 operator in Measure Mode 2

Terminal	Description
Hit 2 = 1st Stop Ch. 1	The first event on stop channel is assigned to HIT2 operator. According to the calculation rule $HIT2 - HIT1$ the ALU now calculates the delay time between the first hit on stop 1 and start. (1st hit on Stop – Start)
Hit 2 = 2nd Stop Ch. 1	Here the second event on stop channel is assigned to HIT2 operator. According to the calculation rule $HIT2 - HIT1$ the ALU now calculates the delay time between the second hit on stop 1 and

	start. (2nd hit on Stop – Start)
Hit 2 = 3rd Stop Ch. 1	Specifies that the third event on stop channel is assigned to HIT2 operator. According to the calculation rule HIT2 - HIT1 the ALU now calculates the delay time between the third hit on stop 1 and start. (3rd hit on Stop – Start)
Hit 1 = Start	In Measure Mode 2 HIT1 is permanently assigned to Start. Delay time measurement between Stop events is not supported in Measure Mode 2.

3.3.2 Define HIT Operator in Measure Mode 1

The TDC-GP22 integrates an arithmetic logic unit to calculate the measurement results. The ALU calculation rule is specified by HIT1 and HIT2 operators. In Measure Mode 1 it always calculates the delay time between HIT1 – HIT2. Because of that, the relevant start and stop events have to be assigned to HIT1 and HIT2, according to your application. In measure mode 1, the GP22 offers more flexibility compared to measure mode 2. Here, the second HIT operator can be arbitrarily assigned to incoming hits. This allows delay time measurement between different incoming stop events in Measure Mode 1.

Example 1:

Hit 1 = 1st Stop Ch. 1, Hit 2 = Start

According to the HIT1 – HIT2 calculation rule, the ALU now calculates the time interval between the first stop on channel 1 and start (1st Stop Ch. 1 - Start).

Example 2:

Hit 1 = 2nd Stop Ch. 1, Hit 2 = 1st Stop ch. 1

According to the HIT1 – HIT2 calculation rule, the ALU now calculates the time interval between the first and the second stop on channel 1 and start (2nd Stop Ch.1 - 1st Stop Ch.1).

Example 3:

Hit 1 = 2nd Stop Ch. 1, Hit 2 = 1st Stop ch. 2

According to the HIT1 – HIT2 calculation rule, the ALU now calculates the time interval between the second stop on channel 1 and the first one on channel 2 (2nd Stop Ch.1 - 1st Stop Ch.2).

3.3.3 Analog settings

In this section the GP22 internal analog functionality can be configured in this section:

Table 3.9: Analog settings

Terminal	Description / Possible Settings
EN_ANALOG	Enables or disables the GP22 analog unit. EN_ANALOG = STOP1 & STOP 2 digital inputs: Disables the analog section (GP2 compatible). Stop 1 and Stop 2 channels operate as pure digital LVTTTL inputs for standard TDC measurements EN_ANALOG = analog section is used: Enables the GP22 analog unit for time-of-flight measurement
Capacitor charge time TW2	Only relevant if analog section is used. Specifies the charge time of the LoadC capacitor. TW2 = 90 μ s TW2 = 120 μ s TW2 = 150 μ s TW2 = 300 μ s (Default)

3.3.4 ALU settings

Table 3.10 ALU Settings

Terminal	Description / Possible Settings
Calibration calculation on	Enables autocalibration mode
Disable Auto-Calibration	Disables autocalibration mode
Measure Mode 2	Activating this item switches TDC-GP22 to Measure Mode 2 Deactivating this item switches TDC-GP22 to Measure Mode 1
EN_AUTOCALC_MB2	By setting this parameter the chip calculates automatically all three hits and their sum. The software reads only the content from read register 4, the sum of the three hits.
Select Timeout Measure Mode 2	Specifies a time interval between 64 μ s and 1024 μ s. If the expected number of hits has not been received within the specified time

[SEL_TIMO_MB2]	interval, the GP22 will indicate a timeout.
----------------	---

3.3.5 Expected number of Hits

Specifies the number of incoming events (hits) on the GP22 stop channels.

Table 3.11 Expected number of hits

Terminal	Description / Possible Settings
Expected No, of Hits Stop 1	Specifies the number of incoming stop events on stop channel 1 (STOP1)
Expected No, of Hits Stop 2	Specifies the number of incoming stop events on stop channel 2 (STOP2)

3.3.6 Edge Sensivity

Specifies the edge sensitivity of the start - / Stop channels

Table 3.12 Edge sensitivity configuration of start-/stop channels

Terminal	Description
Falling Edge START	Sets edge sensitivity of start input to falling edge. Rising edge otherwise.
Falling Edge ch. 1	Sets edge sensitivity of stop 1 input to falling edge. Rising edge otherwise.
Both Edges ch. 1	Sets edge sensitivity of stop 1 input to falling and rising edge (e. g, for pulse width measurement)
Falling Edge ch. 2	Sets edge sensitivity of stop 2 input to falling edge. Rising edge otherwise.
Both Edges ch. 2	Sets edge sensitivity of stop 2 input to falling and rising edge (e. g, for pulse with measurement)

3.3.7 Hardware Diagnosis

Additional functionality for hardware diagnosis is provided by the EN_Start – and the Fire_In pins. This can be configured with parameters SEL_TSTO2 and SEL_TSTO1.

Setting SEL_TSTO2 defines the EN_Start pin as follows:

Table 3.13 SEL_TSTO2 settings for hardware diagnosis

Terminal	Description
SEL_TSTO2 = Start enable	High active enable pin for GP22 start input (default functionality)
SEL_TSTO2 = TOF UP / Down indicator	EN_Start pin acts as TOF up / down indicator. High level indicates that ToD up measurement is active
SEL_TSTO2 = 4 kHz (32 kHz / 8) clock output	The EN_Start pin outputs a 4 kHz clock signal, e. g. for an external microcontroller.

Setting SEL_TSTO1 defines the Fire_In pin as follows:

Table 3.14 SEL_TSTO1 settings for hardware diagnosis

Terminal	Description
SEL_TSTO1 = Fire_In input for sing around	Default functionality. Here, Fire_In can be used as signal input for "sing around" method
SEL_TSTO1 = internal stop window by DELVAL	Enables STOP by DELVAL output
SEL_TSTO1 = Comparator out	Output signal from the GP22 internal comparator
SEL_TSTO1 = 32 kHz out	Fire_In outputs a 32 kHz clock signal for an external microcontroller

3.4 Standard TDC Measurement

If the TDC-GP22 operates as a pure digital Time-to-Digital Converter the “Standard TDC Measurement Tab” is used to configure the device.

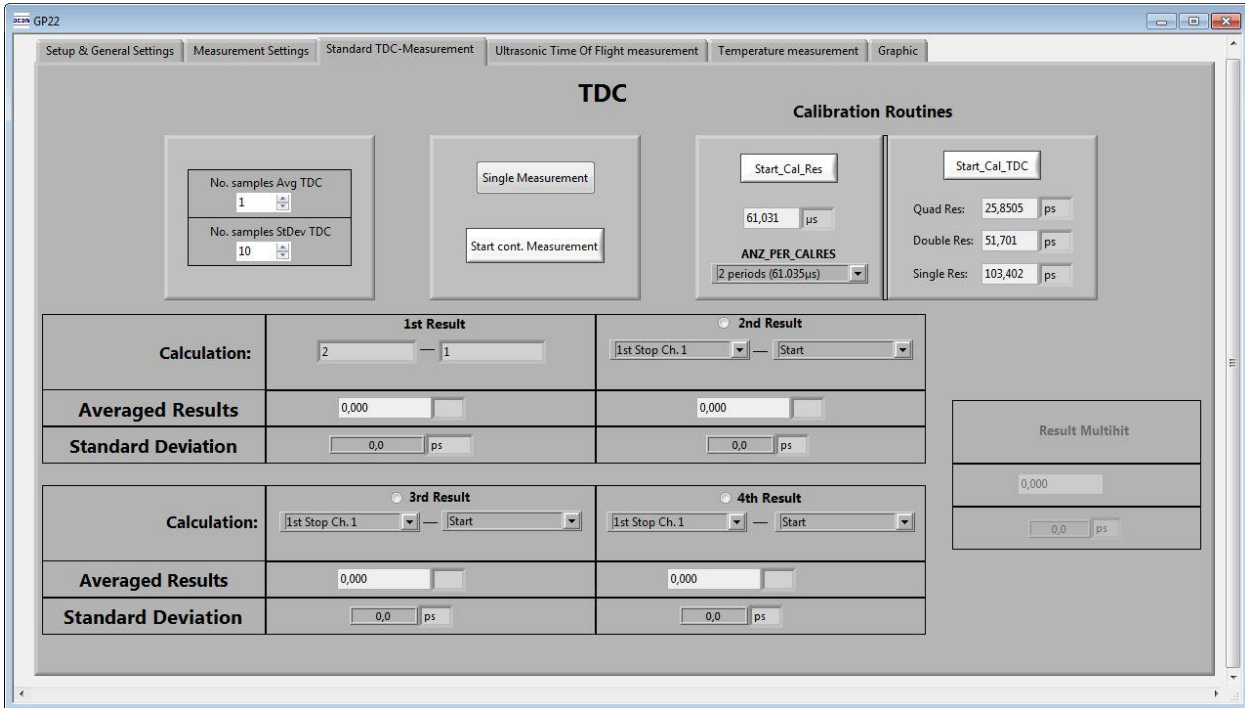

Figure 3.15 Standard TDC Measurement

3.4.1 TDC

Table 3.15: TDC measurement settings

Terminal	Description
No. samples Avg. TDC	Specifies the sample size that is used for averaging the measurement results.
No. samples StDev. TDC	Specifies the number of results that are used to calculate the standard deviation
Single Measurement	Executes a single TDC measurement
Start cont. Measurement	Executes continuous TDC measurements

3.4.2 Calibration Routines

Table 3.16: Calibration settings

Terminal	Description
Start_Cal_Res	Starts a calibration of high speed oscillator and display the result in the corresponding text field
ANZ_PER_CALRES	Defines the number of 32,768 Hz clock periods that are used for calibrating the high speed clock.
Start_Cal_TDC	Executes a calibration run of the TDC itself and displays the result in the corresponding text field.

3.4.3 Calculation

Displays the ALU calculation rule. In applications with multiple stop hits activate the radio button for 2nd, 3rd and 4th result, according to the requested number of hits and enter the calculation rule in the corresponding text field.

3.4.4 Averaged Results

Displays the measured results. In case of averaging, the mean value of the measured results is displayed, according to the sample size that is set by the parameter "No. samples Avg. TDC"

3.4.5 Standard Deviation

Displays the standard deviation of the measured results. The number of results that are used for calculating the standard deviation is set by the parameter "No. samples StDev. TDC"

3.5 Ultrasonic Time-of-Flight Measurement

If the analog input unit is used, the TDC-GP22 operates as ultrasonic front-end device that greatly simplifies development of ultrasonic flow- and heat meters. Then the “Ultrasonic Time Of Flight measurement” Tab is used for configuration.

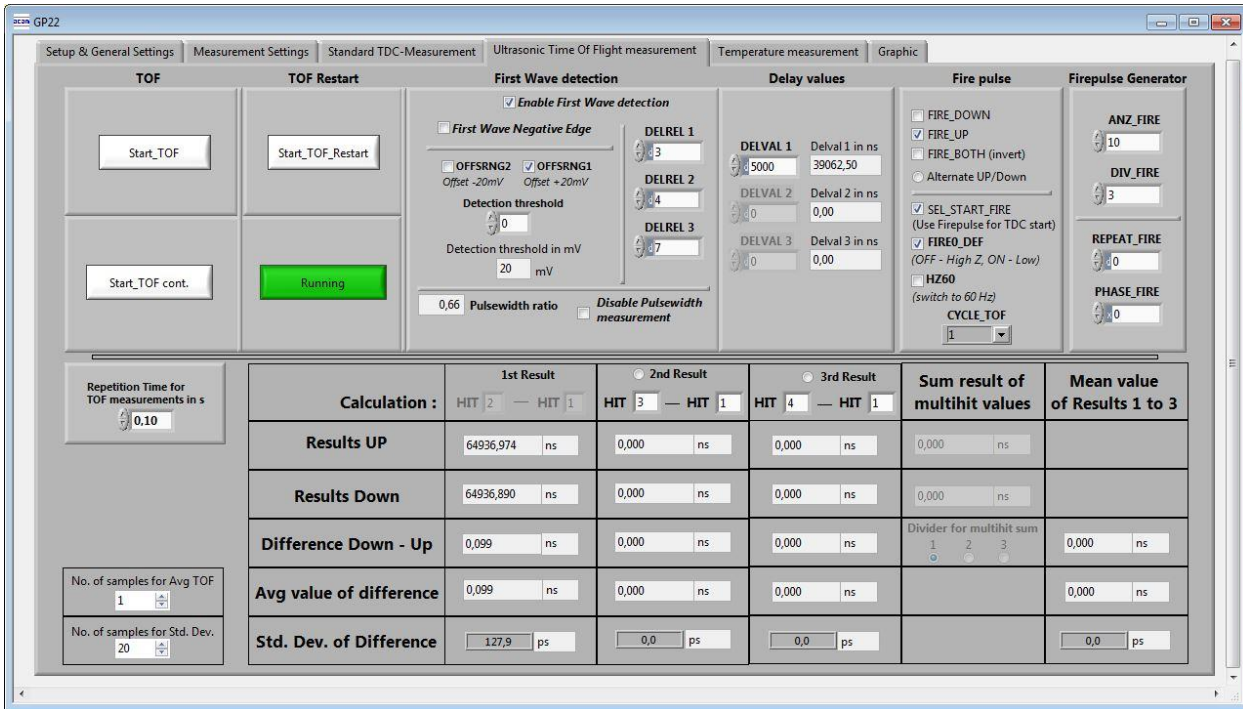

Figure 3.16: Ultrasonic Time-of-Flight Measurement

3.5.1 TOF and TOF Restart Sections

Table 3.17: TOF / TOF Restart

Terminal	Description
Start_TOF	Executes a single time-of-flight measurement sequence per mouse click.
Start_TOF cont.	Executes the time-of-flight measurement sequence continuously.
Repetition Time for TOF measurements in s	Pressing the up / down arrows or inserting a value sets the period for continuous (periodical) time-of-flight measurement runs.
Start_TOF_Restart	Runs a time-of-flight measurement sequence twice, in up- and down direction, as is typical for ultrasonic flow meters.
Start_TOF_Restart	A combination of the above. Starts up/down double sequences

cont.	periodically.
-------	---------------

3.5.2 First Wave Detection

This section configures the automatic first wave detection and the additional pulsewidth measurement as these are new features in TDC-GP22.

Table 3.18 First Wave Detection

Terminal	Description
Enable First Wave Detection	Selects the automatic first wave detection.
First Wave Negative Edge	Selects first wave detection on the falling edge. Default is off, triggering on the rising edge.
OFFSRNG2	Adds -20 mV to the variable offset for the first wave detection.
OFFSRNG1	Adds +20 mV to the variable offset for the first wave detection.
Detection Threshold	Setting the variable offset from -16 mV to +15 mV.
Detection Threshold in mV	Displays the total offset in mV as it is given by the variable part and the OFFSRNG settings.
DELREL1, DELREL2, DELREL3	Defines which hits relative to the first hit shall be measured.
Pulsewidth ratio	Displays the ratio of the pulse width for the first wave compared to the pulse width of the first measured hit. Typically in the range of 0.3 to 0.9.
Disable Pulsewidth measurement	Setting this flag disables the pulse width measurement.

3.5.3 Delay Values

This section configures the time-based masking windows for each of the up to three stop events by setting of the DELVAL 1 to DELVAL3 parameters. With first wave detection

being active only DELVAL1 is valid and used to suppress initial disturbance e.g. by the fire pulses.

Table 3.19 Stop Masking

Terminal	Description
DELVAL1	Specifies the time masking window for the first stop hit on stop 1 channel. Stops will only be accepted after the specified delay time value. This window is active also with first wave detection and set default to 5000 (39 μ s) to suppress noise from the fire pulses.
DELVAL2	Specifies the time masking window for the second stop hit on stop 1 channel. Stops will only be accepted after the specified delay time value.
DELVAL3	Specifies the time masking window for the third stop hit on stop 1 channel. Stops will only be accepted after the specified delay time value.

3.5.4 Fire Pulse

Provides the basic configuration set for the GP22 internal fire pulse generator.

Table 3.20 Basic configuration parameters of the fire pulse generator

Terminal	Description
FIRE_DOWN	Sends the pulse sequence for the time-of-flight measurement from FIRE_DOWN output. In combination with the Start_TOF_Restart command the time-of-flight measurement sequence begins with a measurement in down direction.
FIRE_UP	Sends the pulse sequence for the time-of-flight measurement from FIRE_UP output. In combination with the Start_TOF_Restart command the time-of-flight measurement sequence is started with a measurement in up direction.
FIRE_BOTH	Inverts the output signal on FIRE_DOWN output. This option offers the possibility to increase the signal amplitude on the transmitter side if the transducer is connected between FIRE_UP and FIRE_DOWN.
SEL_START_FIRE	When this item is activated, the fire output is connected chip internally to the TDC-Start, so the output signal on fire out is used as a start for the time measurement unit. As the external Start input channel is disabled, any events on that channel will be ignored.

FIREO_DEF	Specifies the default level of the inactive fire buffer. Activating this item sets idle state of the fire buffer to low, disabling sets the idle state to High-Z (GP2 compatible)
HZ60	On = Uses 60 Hz time base between an up- and down flow measurement (16,67 ms) Off = Uses 50 Hz time base between an up- and down flow measurement (20 ms)
CYCLE_TOF	Specifies a pause between the up and the down run of a combined up/down sequence. CYCLE_TOF is multiplied by the 50 or 60 Hz period (20 or 16.7 ms), according to the HZ60 setting.

3.5.5 Firepulse Generator

Here, the signal burst that is sent from the Fire pulse generator can be configured

Table 3.21 Parameters to configure transmitted pulse packet

Terminal	Description
ANZ_FIRE	Selects the number of pulses that are sent within a pulse sequence. It can range between 1 and 127.
DIV_FIRE	Sets a pre-divider for the internal clock in order to adjust the output frequency of the pulse burst that is sent by the fire pulse generator. It can range between 1 (divider = 2) and 15 (divider = 16).
REPEAT_FIRE	Specifies the number of repetitions for the pulse sequence.
PHASE_FIRE	Defines the phase of each pulse that is sent. Binary "0" stands for a high-low- phase (falling signal edge) and binary "1" for a low-high-phase (rising signal edge). The pulse sequence starts with the LSB and ends with the MSB.

3.5.6 Data Display

Table 3.22 Display of time measurement data

Terminal	Description
----------	-------------

Calculation	Displays the ALU calculation rule. For multi hit applications activate the radio button for 2 nd and 3 rd result, according to the requested number of hits and enter the calculation rule in the corresponding text field.
Results Up	Displays the Time-of-flight measured in up direction. For multi hit applications activate the radio button for the 2 nd and 3 rd , according to the requested number of hits and enter the calculation rule in the corresponding text field.
Results Down	Displays the Time-of-flight measured in down direction. For multi hit applications activate the radio button for the 2 nd and 3 rd , according to the requested number of hits and enter the calculation rule in the corresponding text field.
Difference Down - Up	Displays the delay time of a complete up-/down time-of-flight measured in sequence. For multi hit application activate the radio button for the 2 nd and the 3 rd hit, according to the requested number of hits and enter the calculation rule in the corresponding text field. The mean value of the measured result is shown in the last column.
Average Value of Difference	Displays the averaged delay time of a complete up-/down time-of-flight measurement sequence. The sample size for averaging is specified in the "No. of samples for Avg. TOF" field. Again, for multi hit applications activate the radio button for the 2 nd and the 3 rd hit, according to the requested number of hits and enter the calculation rule in the corresponding text field. The mean value of result 1 to 3 over the specified sample size is shown in the last column.
StDev. of Difference	Displays the standard deviation of the time difference Down - Up calculated from as many hits as defined in the "No. of samples for StDev." field.
Sum result of multihit values	Is the sum of the multihit measurement as it is calculated inside the TDC-GP22 when EN_AUTOCALC_MB2 is set. The software reads only the sum from register 4. It is necessary to set the divider for the the number of multihits to get the right time data.
Mean value of Results 1 to 3	Displays the mean of the three multihits as it is calculated by the evaluation software.
No. of samples for Avg. TOF	Set the number of samples that is used to calculate the average value of the time of flight difference.
No. of samples for StDev.	Set the number of samples that is used to calculate the standard deviation of the time difference.

3.6 Temperature Measurement

The GP22 integrated temperature measurement unit provides the possibility for temperature difference measurement. It is configured in the "Temperature measurement" sheet.

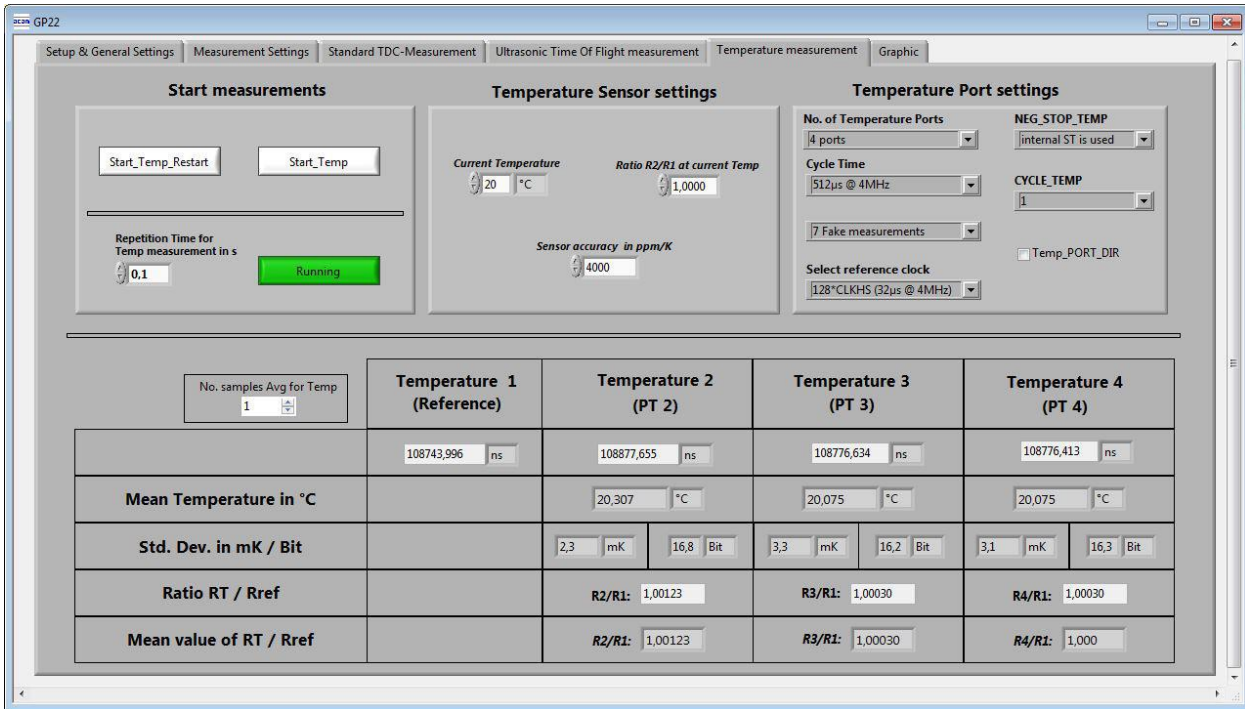

Figure 3.17: Temperature Measurement

3.6.1 Start measurements

Table 3.23 Start option for temperature difference measurement

Terminal	Description
Start_Temp_Restart	A mouse click on this button runs a temperature difference measurement cycle twice, for hot and cold, as is typical in ultrasonic heat meters.
Start_Temp	Executes a single temperature measurement sequence
Repetition Time for Temp measurement s	Pressing the up-/down arrows or inserting a value in the text field sets the period for the periodical temperature measurements.
Start_Temp_cont	Here, the Start_Temp command is repeated continuously. The repetition period is specified in "Repetition Time for Temp. measurements in s"

3.6.2 Temperature sensor settings

Specifies additional parameters that refer to the environmental conditions of the temperature difference measurement and the RTD sensor that is used.

The values that are entered in the corresponding text field are used to calculate the results that are displayed in this tab.

Table 3.24 Temperature sensor settings

Terminal	Description
Current Temperature	Specifies the ambient temperature. The corresponding value is subtracted from the measured results in order to calculate the absolute temperature difference
Ratio R2/R1 at current temperature	Specifies the R2/R1 ratio at current ambient temperature
Sensor accuracy in ppm/K	Specifies the accuracy of the temperature sensor that is used.

3.6.3 Temperature port settings

This section contains the basic parameters to configure the TDC-GP2 temperature measurement ports.

Table 3.25: Temperature port settings

Terminal	Description
No. of Temperature Ports	Specifies the number of temperature ports that are used for temperature measurement. If 2 ports are selected, only PT1 and PT2 can be used for temperature measurement.
Cycle Time	Defines the time interval to charge and discharge the Load capacitor (Cload) for temperature measurement.
Fake measurements	Specifies the number of fake measurements within a temperature measurement sequence.
Select reference	Selects the reference clock source that triggers the temperature

clock	measurement unit.
NEG_STOP_TEMP	Specifies if the internal or external comparator is used Ext. 74HC14 is used = selects external comparator Internal ST is used = selects integrated comparator
CYCLE_TEMP	Specifies a pause between the "hot" and the "cold" run of a combined hot/cold sequence. CYCLE_TEMP is multiplied by the 50 or 60 Hz period (20 or 16.7 ms), according to the HZ60 setting.
Temp_PORT_DIR	Temperature ports are measured in opposite order: On = PT1 > PT2 > PT3 > PT4 Off = PT4 > PT3 > PT2 > PT1

3.6.4 Data Display

Table 3.26 Display of temperature measurement data

Terminal	Description
Temperature 1 to 4	The TDC-GP22 provides raw discharge time data only. Any calculations are done by the software. This display assumes that the reference is at port PT1.
Mean Temperature in °C	Displays the temperature calculated from the ratio PT_x/PT_1 on the basis of the platinum temperature curve.
StDev. in mK/Bit	Displays the standard deviation in Millikelvin and the resolution in Bit on the basis of sample size defined under „No. samples Avg. for Temp.“
Ratio RT/Rref	Displays the ratios of PT_x / PT_1
Mean value of RT/Rref	Displays the average calculated with samples size defined under „No. samples Avg. for Temp.“

3.7 Graphic

This page is for the graphical display, showing the measurement results (y) over runtime (x). The scales can be modified directly by editing the corner values or by using the magnifying glass tool.

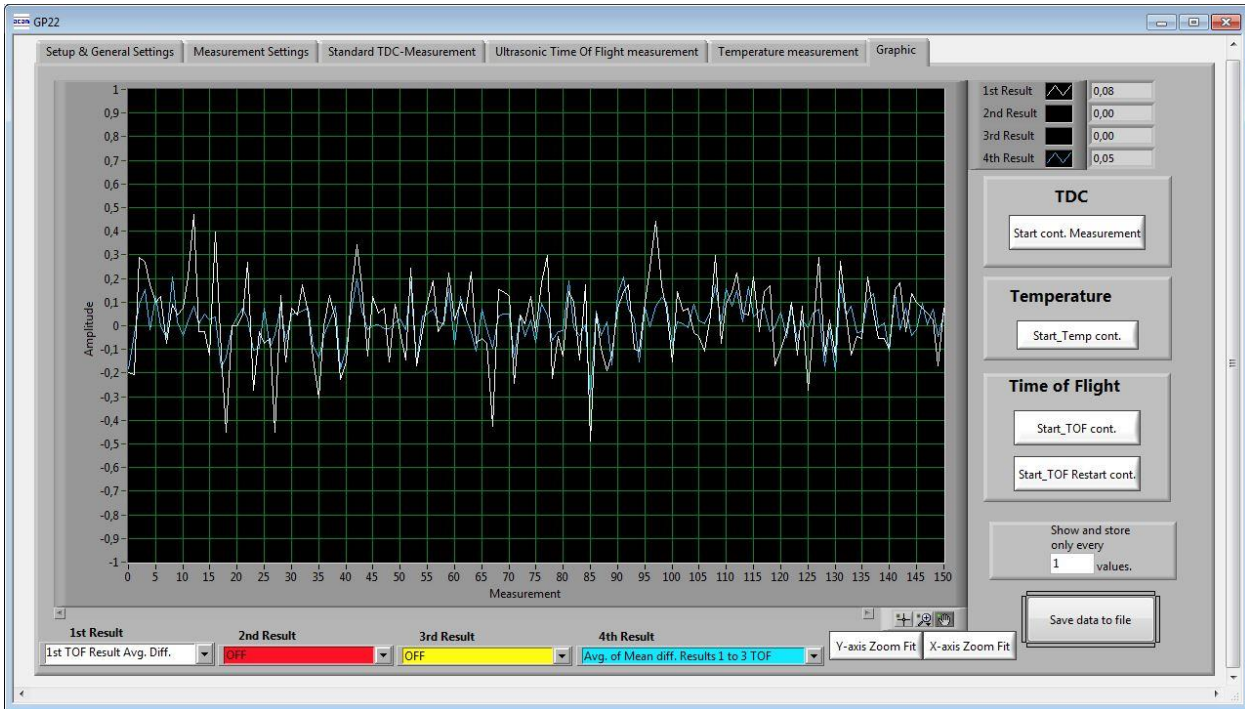

Figure 3.18 Graphical Display of the results

Table 3.27: Controls

Terminal	Description
1st Result to 4th Result	Selects the results that are displayed in this tab. The pulswidth measurement can be selected under 3rd Result. The sum or average of all 3 results can be displayed under 4th Result.
TDC	Pushing the “Start cont. Measurement” - button in the TDC section starts a continuous measurement cycle if the TDC-GP22 operates as a pure digital converter without the use of the analog section.
Temperature	A mouse click on the “Start_Temp cont” - button in the Temperature section of this tab starts a continuous temperature measurement.
Time-of-flight	Pushing” Start_TOF cont.” button executes the time-of-flight measurement sequence continuously. A mouse click on “Start TOF_Restart cont.” continuously runs a time-of-flight measurement sequence twice, in up- and down direction, as it is typical for ultrasonic flow meters.

Show and store every X Result	Offers the possibility to partly show and store the measured results, e. g. in long term investigation.
Save data to file	Stores the measured results in an ASCII file. The max. number of results is 128,000.
X-/ Y-Zoomfit	Enables scaling of the X and Y.-axis for Display of the measured results

4 Layout and Schematics

4.1 Evaluation Board BOM

Table 4.1 GP22-EVA-KIT BOM

Qty	Reference	Value	Part	Description
1	U3		74AHC1G14/SOT	Inverting Schmitt
3	C3 C6-7	100n	C805,100n	CHIP-CAPACITOR
4	C8-11	10p	C805,10p	CHIP-CAPACITOR
1	C2	10u	C805,10u	CHIP-CAPACITOR
2	C12-13	4n7	C805,4n7	CHIP-CAPACITOR, COG Type
3	C14-16	n.c.	C805,C1206	CHIP-CAPACITOR
1	C4	22u	ELKO/49MC_B,22u	Tantal Bf. B
1	C5	100u	ELKO/49MC_C,100u	Tantal Bf. C
1	U2		GP22/QFN32	TDC GP22
1	D2	Green	LED/HSMX-PLCC2,Green	Surface Mount LED
1	D1		LL4148	DIODE
1	U1		LT1761	100mA Low Noise LDO
6	LJ1-6		Solder Connector	
3	J22-24		PAD80/40	PAD 80 / 40 mil
1	X2	4MHz	Q/CSTCR 4M00 G53A -RO, 4 MHz	CERAMIC RESONATOR
1	X1	4MHz	Q/HC49/4HSMX,4MHz	Quartz Oscillator
1	X3	32,768 kHz	Q/KX-327XS,32,768kHz	Quartz Crystal
2	R1 R6	0R	R805,0R	CHIP-RESISTOR
1	R2	100k	R805,100k	CHIP-RESISTOR
6	R21-22 R24 R33- 35	100k	R805,100k	CHIP-RESISTOR
1	R23	10M	R805,10M	CHIP-RESISTOR
2	R3 R12	10R	R805,10R	CHIP-RESISTOR

1	R11	120k	R805,120k	CHIP-RESISTOR
1	R8	1M	R805,1M	CHIP-RESISTOR
1	R29	1k	R805,1k	CHIP-RESISTOR, 50 ppm
1	R9	20k	R805,20k	CHIP-RESISTOR
1	R5	22k	R805,22k	CHIP-RESISTOR
2	R27-28	330R	R805,330R	CHIP-RESISTOR
1	R10	330k	R805,330k	CHIP-RESISTOR
1	R7	430k	R805,430k	CHIP-RESISTOR
1	R4	470k	R805,470k	CHIP-RESISTOR
2	R25-26	47k	R805,47k	CHIP-RESISTOR
1	R13	4R7	R805,4R7	CHIP-RESISTOR
1	R30	500R	R805,500R	CHIP-RESISTOR, 50 ppm
1	R20	560k	R805,560k	CHIP-RESISTOR
4	J2-5		ST/254_2	2-PIN Header
4	J11-14		ST/254_1_ACAM	FASTON TAB 2.8
3	J9-10 J17		ST/254_3_1R	3-PIN HEADER
2	J20-21		ST/254_4_ACAM2	
1	J15		ST/254_6_2R_90	
1	J19		ST/254_9_1R	9-PIN HEADER 2,54mm 9 polig
1	J1		ST/DSUB15HD_ABG	15 Pole Male DSUB Plug
3	J6-8		ST/SMB_LPM_90	
1	J16		TESTPOINT	GND
1	J18		TESTPOINT2	Fire In

4.2 Layout/Schematics

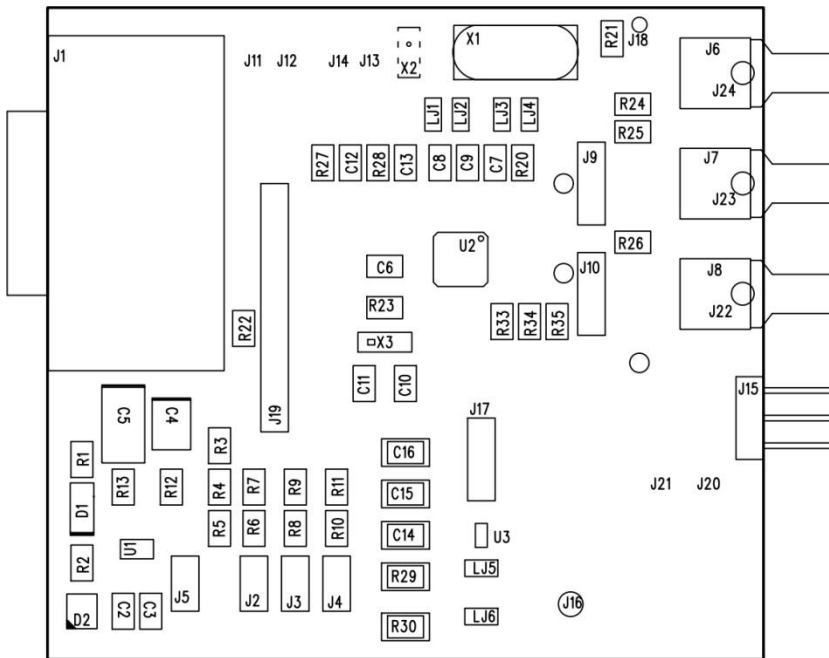

Figure 4.1 Component Placement

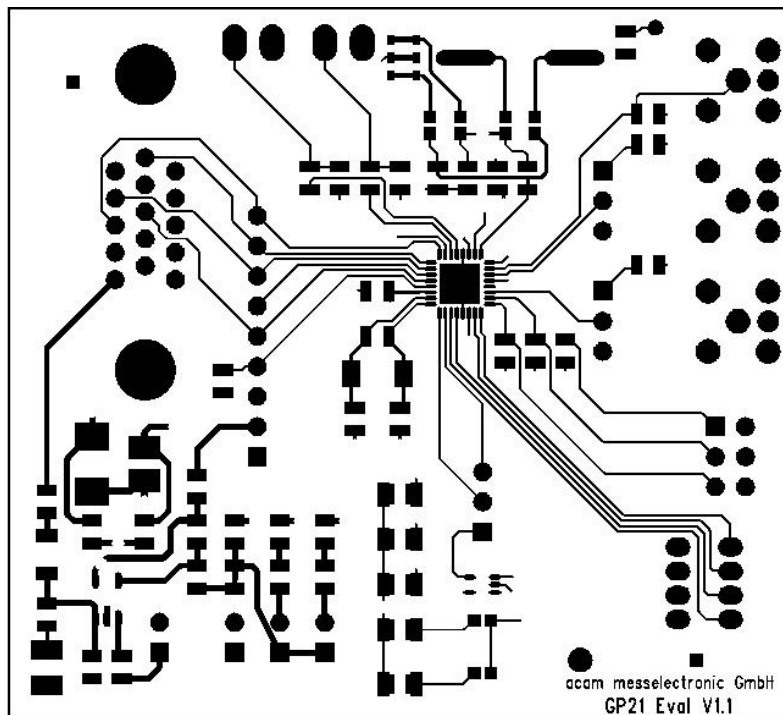

Figure 4.2 PCB Layer 1

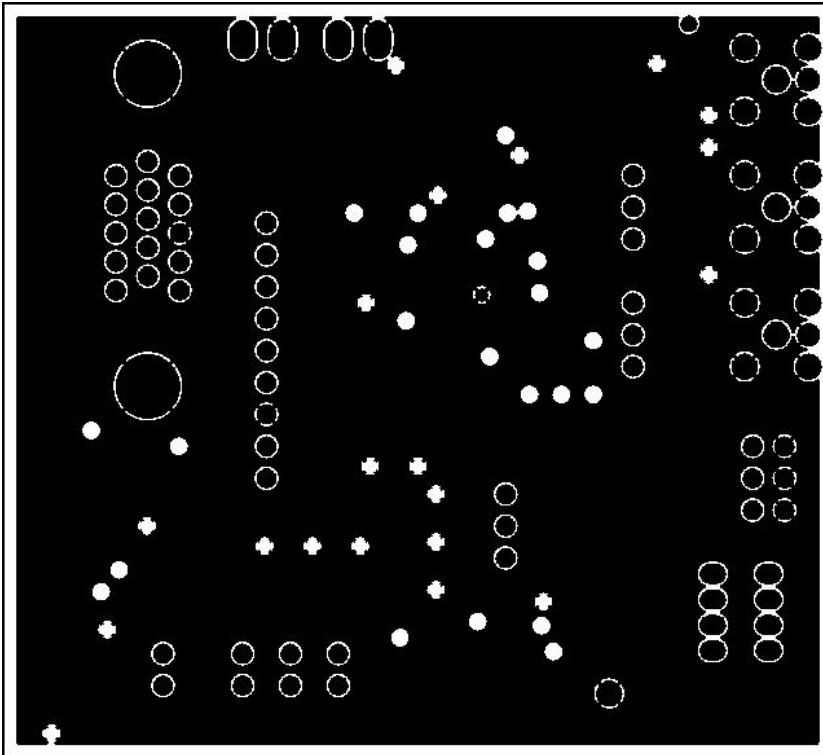

Figure 4.3 PCB Layer 2 (GND)

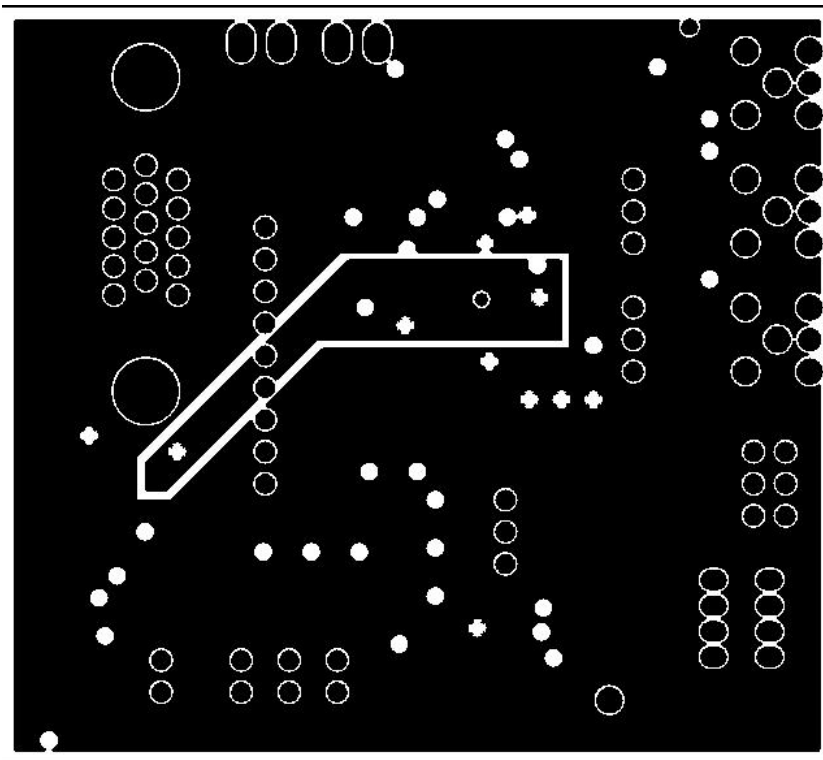

Figure 4.4 PCB Layer 3 (Power Supply)

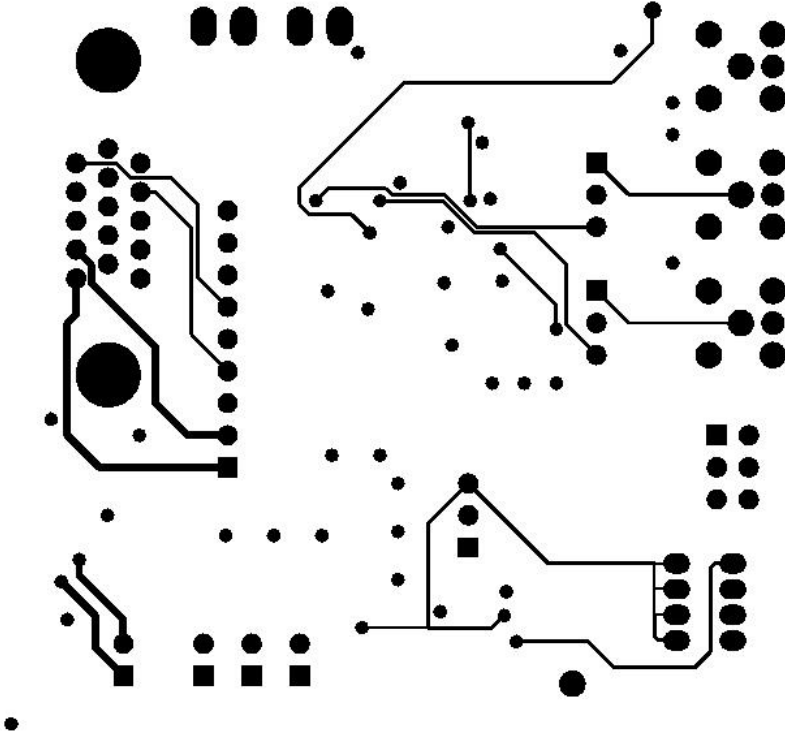

Figure 4.5 PCB Layer 3 (Bottom View)

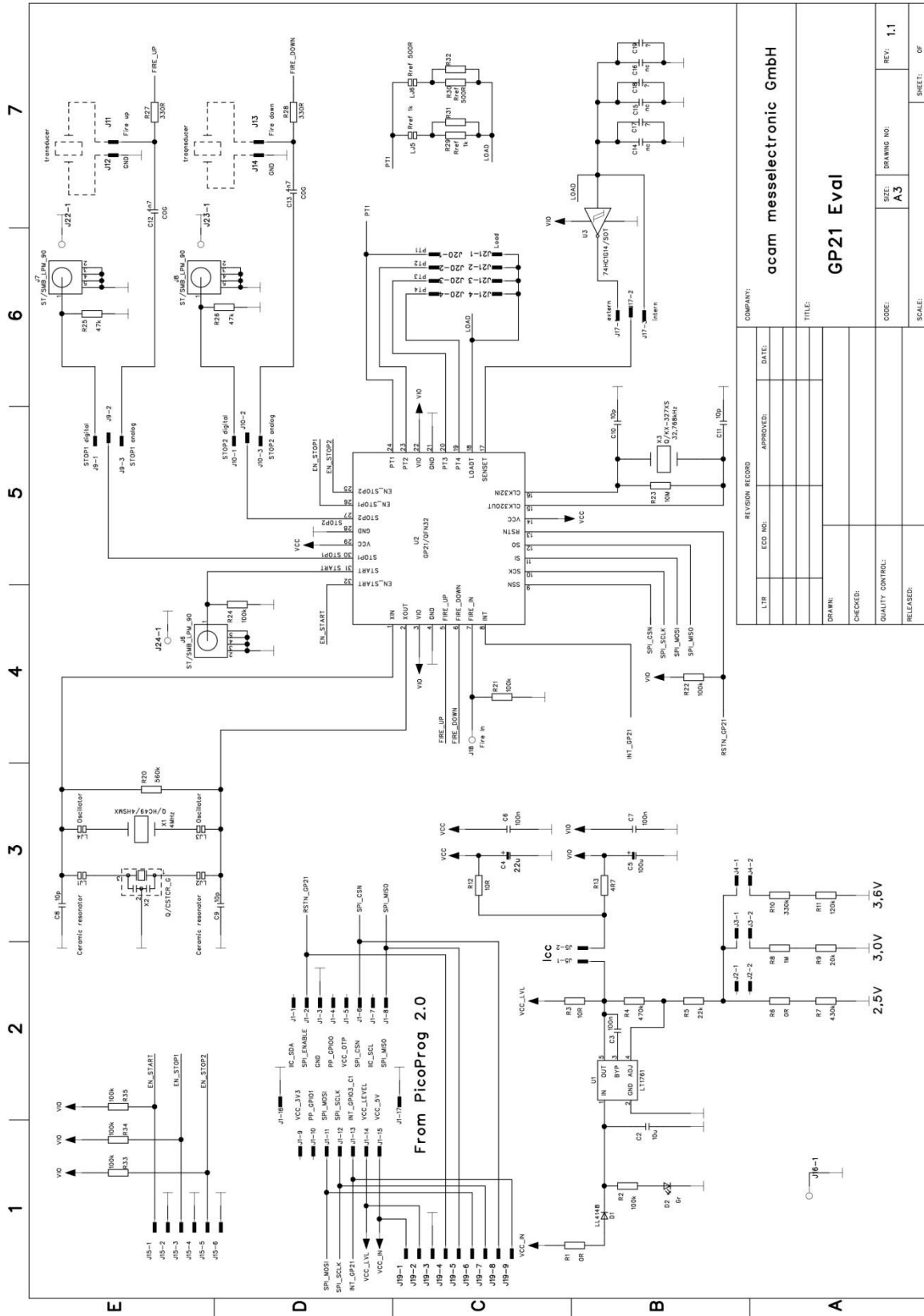

Figure 4.6 Schematics

5 Miscellaneous

5.1 Literature Guide

Datasheets

Title	Document-No.
TDC-GP22 Datasheet	DB_GP22_en

Application Notes

Title	Document-No.
TDC-GP2 to TDC-GP21 Migration and Compatibility Guideline	ANO27_en
Ultrasonic Heat metering with the TDC-GP21 Time-to-Digital Converter	ANO29_en
Ultrasonic Water & Heat Metering with TDC-GP22	ANO32_en

The latest versions of the available documents can be downloaded from the acam website at:

<http://www.acam.de/download-center/ultrasonicflowconverter/>

5.2 Last Changes

05.06.2012 First release

15.07.2013 Version 0.2 for release, new screenshots in section 3